



# CleanView<sup>®</sup> II

BAGLESS

## USER'S GUIDE

3574/3576 SERIES

3 Safety Instructions

4 Product View

5-6 Assembly Instructions

6-8 Operation / Special Tools

8-12 Maintenance

12-13 Troubleshooting

14 Replacement Parts

15 Consumer Services

16 Warranty

DJ68-00280A REV(0.1)

## Thanks For Buying A BISSELL CleanView® II

We're glad you purchased a BISSELL CleanView II Vacuum. Everything we know about floor care went into the design and construction of this complete, high-tech home vacuuming system.

Your BISSELL CleanView II is well made, and we back it with a limited comprehensive one-year warranty. We also stand behind it with a knowledgeable, dedicated Consumer Services Department, so, should you ever have a problem, you'll receive fast, considerate assistance.

My great-grandfather invented the floor sweeper in 1876. Today, BISSELL is a global leader in the design, manufacture, and service of high quality homecare products like your BISSELL CleanView II.

Thanks again, from all of us at BISSELL.

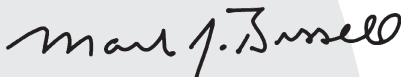

Mark J. Bissell  
President and Chief Executive Officer

## How To Use This Guide

This User's Guide has been designed to help you get the most satisfaction from your BISSELL CleanView II. You'll find assembly and operating instructions, safety precautions, as well as maintenance and troubleshooting instructions. Please read this Guide thoroughly before assembling your vacuum cleaner.

Pay particular attention to the product diagram, assembly instructions, and part names. Locate and organize all parts before assembly. Familiarize yourself with the parts and where they fit. Following this User's Guide will greatly enhance your ability to get the most performance from your BISSELL CleanView II for many years.



### **WARNING:**

Plastic film can be dangerous. To avoid danger of suffocation, keep away from babies and children.

## IMPORTANT SAFETY INSTRUCTIONS

When using an electrical appliance, basic precautions should be observed, including the following:

### READ ALL INSTRUCTIONS BEFORE USING YOUR UPRIGHT VACUUM.

Always connect to a polarized outlet (left slot is wider than right). Unplug from outlet when not in use and before conducting maintenance.

### **WARNING:** To reduce the risk of fire, electric shock, or injury:

- Do not modify the polarized plug to fit a non-polarized outlet or extension cord.
- Do not leave vacuum cleaner unattended when it is plugged in.
- Unplug from outlet when not in use and before servicing.
- Do not use outdoors or on wet surfaces.
- Do not allow children to operate vacuum cleaner or use as a toy.
- Close attention is necessary when used by or near children.
- Do not use for any purpose other than described in this User's Guide.
- Use only manufacturer's recommended attachments.
- Do not use with damaged cord or plug.
- If appliance is not working as it should, has been dropped, damaged, left outdoors, or dropped into water, have it repaired at an authorized service center.
- Do not pull or carry by cord, use cord as a handle, close a door on cord, or pull cord around sharp edges or corners. Do not run appliance over cord. Keep cord away from heated surfaces.
- Do not unplug by pulling on cord. To unplug, grasp the plug, not the cord.
- Do not handle vacuum cleaner or plug with wet hands.
- Do not put any object into openings. Do not use with any opening blocked; keep openings free of dust, lint, hair, and anything that may reduce air flow.
- Keep hair, loose clothing, fingers, and all parts of body away from openings and moving parts.
- Turn off all controls before plugging or

unplugging vacuum cleaner.

- Use extra care when cleaning stairs.
- Unplug before attaching the turbobrush.
- Do not pick up flammable materials (lighter fluid, gasoline, kerosene, etc.) or use in the presence of explosive liquids or vapors.
- Do not pick up toxic material (chlorine bleach, ammonia, drain cleaner, etc.).
- Do not use vacuum cleaner in an enclosed space filled with vapors given off by oil base paint, paint thinner, some moth proofing substances, flammable dust, or other explosive or toxic vapors.
- Do not pick up hard or sharp objects such as glass, nails, screws, coins, etc.
- Do not pick up anything that is burning or smoking, such as cigarettes, matches, or hot ashes.
- Do not use without filters in place.
- Use only on dry, indoor surfaces.
- Keep appliance on a level surface.
- Do not carry the vacuum cleaner while it is running.

### SAVE THESE INSTRUCTIONS FOR FUTURE USE

### THIS APPLIANCE HAS A POLARIZED PLUG.

To reduce the risk of electric shock, this appliance has a polarized plug (one blade is wider than the other). This plug will fit in a polarized outlet only one way. If the plug does not fit fully in the outlet, reverse the plug. If it still does not fit, contact a qualified electrician to install a proper outlet. Do not change the plug in any way.

This model is for household use only.

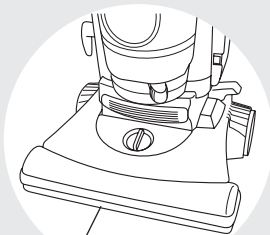
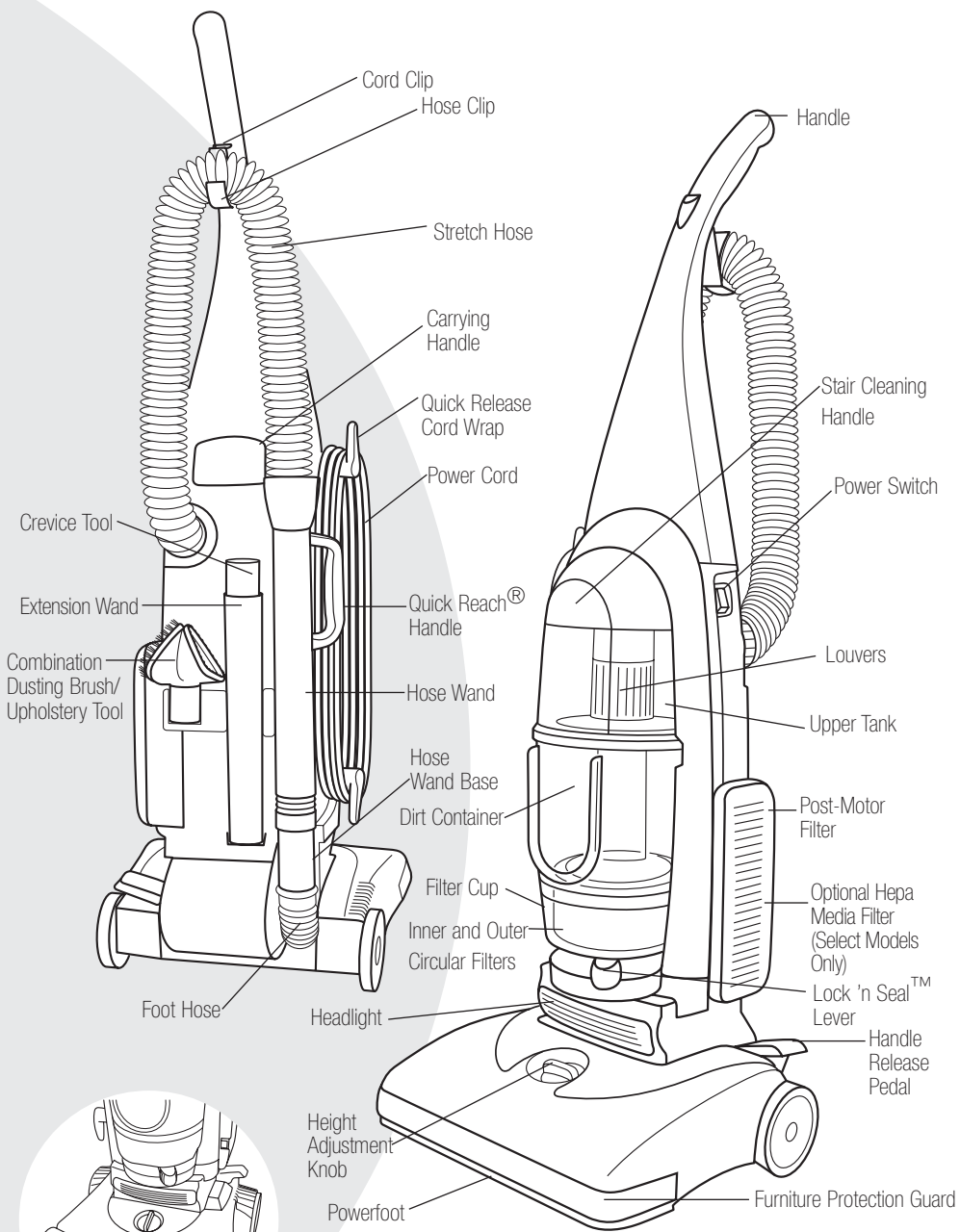

Furniture Protection Guard  
Wide Cleaning Path Models

**⚠ CAUTION:**  
Do not plug in your vacuum cleaner until you are familiar with all instructions and operating procedures.

## How To Put It Together

The only tool you'll need to assemble your vacuum cleaner is a screwdriver.

### Attach Handle To Vacuum

1. Locate the vacuum Handle and remove the screw packet taped to the base of the Handle.
2. Stand the vacuum upright and slide the base of the Handle firmly into the grooves at the top of the vacuum body.
3. Check to be sure the Handle is fitted to the vacuum body. If there is a gap in front, continue to push firmly until the Handle is flush.
4. Insert the screw provided from the screw packet into the existing hole. Tighten securely with a screwdriver.

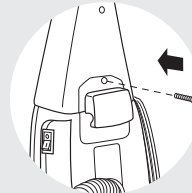
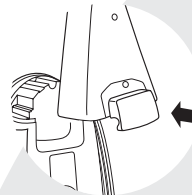

### Attach Vacuum Hose and Tools

1. Attach the Twist 'n Snap™ Hose by lining up the tabs on the base with the corresponding notches on the back of the vacuum as shown.
2. Turn the Twist 'n Snap Hose to the right to lock the hose into place.
3. Grasping the Quick Reach Handle, slide the end of the Hose Wand onto the Hose Wand Base. Snap the Hose into the Hose Clip.

**NOTE: The Powerfoot will not operate effectively unless the Hose Wand is firmly attached.**

4. Snap the Extension Wand and the Crevice Tool together into the storage clip as shown.
5. Snap the Combination Tool into the storage clip as shown.
6. Attach the TurboBrush® by aligning the small holes near the brush roll with the tabs at the bottom of TurboBrush housing. Snap TurboBrush into place as shown.

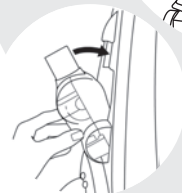
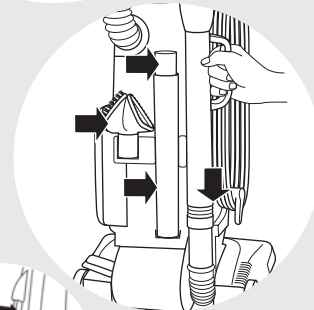
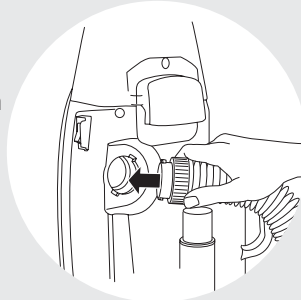

Select Models Only

## How To Use Your Vacuum

### Handle Positions

Press the Handle Release Pedal with your foot to place your vacuum in one of three cleaning positions.

1. Upright- For storage and above floor cleaning with tools.
2. Normal Cleaning- Press Handle Release Pedal once. Use for most household floor cleaning tasks.
3. Low Cleaning- With the vacuum in normal cleaning position, press Handle Release Pedal again. Use for reaching under low furniture such as tables, chairs or beds.

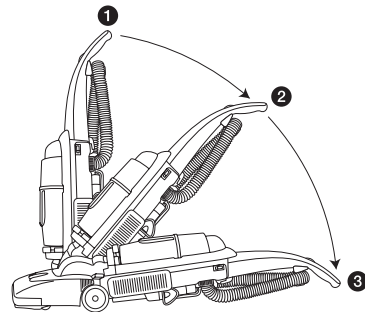

### Height Adjustment

The Powerfoot/Rotating Floor Brush can be adjusted to clean several floor surfaces.

**NOTE: For optimal cleaning performance, adjust to the lowest practical setting. If your cleaner is difficult to push, adjust to the next higher setting.**

1. Place Handle in Upright Position.
2. Turn Height Adjustment Knob to desired setting.
 

<b>Lowest Setting</b>	For bare floors.
<b>Medium Settings</b>	For short and medium pile carpets.
<b>Highest Setting</b>	For plush pile carpet.
3. Place the Handle in the normal cleaning position and the Powerfoot will adjust to the setting chosen.

**NOTE: You may also adjust the setting while in the normal cleaning position.**

**CAUTION:**  
Before using your vacuum, make sure that the Dirt Container is in locked position and that all filters (Inner Circular, Outer Circular, Pre-Motor and Post-Motor) are in place. Do not operate your vacuum without these filters.

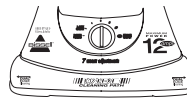
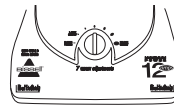

### Tip:

Before cleaning under low furniture, check area first for objects that might harm the unit or block the Vacuum Hose.

### Tip:

Your vacuum features a Quick Release Cord Wrap. To remove the Power Cord quickly and easily, rotate the Upper Cord Wrap towards floor, and slip Power Cord from Upper and Lower Cord Wraps.

### Transporting Cleaner

1. To move your cleaner from room to room, put the Handle in the upright position, tilt the cleaner back on its rear wheels and push forward.
2. The cleaner can also be moved by using the Carrying Handle on the back.
3. Use the Stair Cleaning Handle on the front to hold your vacuum while cleaning stairs.

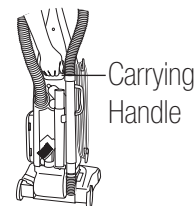
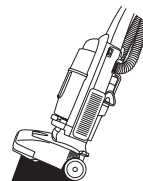

## Special On-Board Tools

Your BISSELL CleanView II is not only a powerful carpet and rug vacuum cleaner, it's also a versatile above floor vacuum cleaner when you select one of the special tools.

1. Raise Handle to Upright Position.
2. Grasp the Quick Reach Handle and lift Hose Wand to separate from suction intake opening.
3. Attach tools by firmly pushing onto Vacuum Hose or Extension Wand.

### Combination Dusting Brush/Upholstery Tool:

Two types of cleaning tools are included in one attachment: rotate for desired tool.

- Use Brush side to dust furniture, blinds, books, lamps, shelves, and baseboards.
- Use Upholstery side for curtains, draperies, cushions, fabrics.

### Crevice Tool:

Use in tight narrow spaces.

### Extension Wand:

Use with desired attachment for a longer reach.

### TurboBrush® (Select Models):

Use rotating brush action for small areas such as stairs and upholstery.

**Note:** Press gently when using TurboBrush to gain maximum cleaning. Too much pressure could cause the brush to stop rotating.

## Power Cord Storage

When you are done using your vacuum, return it to the Upright position and store the Power Cord.

1. Turn vacuum cleaner off.
2. Unplug Power Cord by grasping the polarized plug (NOT the cord) and disconnect from outlet.
3. Loop Power Cord around Cord Wraps on side of vacuum cleaner.
4. Clip molded plug to Power Cord to secure.

## NOTICE:

The Floor Brush will continue to rotate while you use your vacuum for above floor cleaning. To prevent carpet damage, do not lean on the vacuum or let the Powerfoot tilt forward.

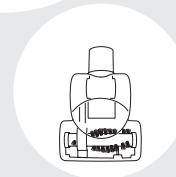
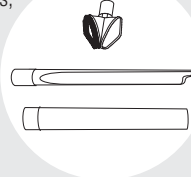
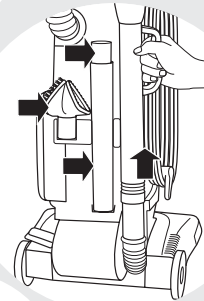

Select Models Only

## Tip:

Hair, string and small objects can block the Vacuum Hose or Tools. Check them occasionally for obstructions.



## CAUTION:

The Rotating Floor Brush continues to rotate while tools are in use. To reduce the risk of injury from moving parts, always move the cleaner with the Carrying Handle at the back of the cleaner. Always place vacuum cleaner on floor with Handle in Upright position when using tools. Never place your fingers under the cleaner when it is running. Never place Powerfoot on furniture or uneven surfaces. Do not place vacuum cleaner close enough to objects to pull them into rotating brush.

## NOTICE:

While vacuuming, certain carpets and low humidity conditions may generate small static discharges. The discharges are entirely harmless and are not associated in any way with the main power supply.

7

## How To Maintain Your Vacuum

To maintain maximum cleaning performance, the following maintenance steps must be performed:

1. Empty the Dirt Container when the dirt reaches the "Full" line on the side.
2. Check the Inner and Outer Circular Filters and the Pre-Motor Filter at least once a month and clean or replace as needed.
3. Replace the Post-Motor Filter every three to six months.

**Note: More frequent filter cleaning or replacing may be necessary if you are vacuuming new carpet, fine dust, or have allergy concerns. Follow the instructions on the following pages to perform these simple maintenance steps.**

### Empty Dirt Container

The Dirt Container needs to be emptied when the dirt reaches the "Full" line on the side of the Container.

1. Unplug cleaner from electrical outlet.
2. Slide the Lock 'n Seal Lever to the "Unlock" position.
3. Grasp handle and pull the Dirt Container straight out to remove from vacuum.
4. Empty dirt into garbage container.
5. Put the Dirt Container back in the vacuum and slide the lever to the "Lock" position.

**Note: The Dirt Container may be washed in warm water with a mild detergent. Remove the Filter Cup from the bottom before washing. Reassemble and make sure it is completely dry before using again.**

### Cleaning The Inner & Outer Circular Filters

Use only BISSELL Style 9 Replacement Filters in your BISSELL CleanView II.

1. Unplug the cleaner from electrical outlet.
2. Remove the Dirt Container as described in the previous section. Grasp the Filter Cup located at the bottom of the Dirt Container and twist counterclockwise to unlock and remove.
3. Grasp the Circular Filters and twist to unlock. Pull straight up to remove.



### WARNING:

To reduce the risk of electric shock, turn Power Switch OFF and disconnect polarized plug from electrical outlet before performing maintenance or troubleshooting checks.

### Tip:

For maximum cleaning performance, check and clean or replace all filters as suggested.

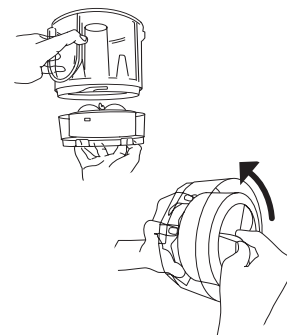
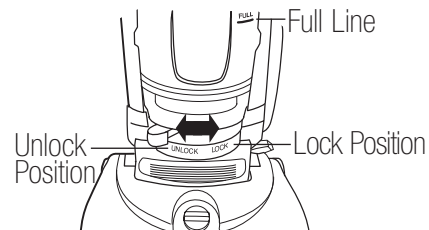



### Cleaning The Inner & Outer Circular Filters

4. Separate the Outer foam and Inner pleated Circular Filters. Wash each individually by hand in warm water. Mild detergent may be used if desired. Rinse well, then air dry thoroughly before putting them back together and replacing in Filter Cup.
5. The Filter Cup may be washed in warm water with a mild detergent. Make sure it is completely dry before reassembling with filters.
6. The Upper Tank and Louvers may also be wiped clean with a damp cloth. Reach underneath the Upper Tank and turn the rim of the Louvers to unlock. Pull straight down to remove.



### Cleaning the Pre-Motor Filter

1. Unplug the cleaner from electrical outlet.
2. The Pre-Motor Filter protects the motor from debris. It is located underneath the Dirt Container and Filter Cup in the center of the round part of the Lock 'n Seal Lever.
3. Remove the small round Filter and any debris on top of it. Rinse well under warm water, then air dry thoroughly before replacing.

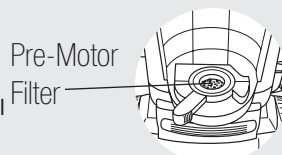

### Replacing the Post-Motor Filter

Use only BISSELL Style 9 Replacement Filters in your BISSELL CleanView II.

1. Unplug the cleaner from electrical outlet.
2. The Post-Motor Filter assists in the filtration process to return clean air to the room. It is located behind the door on the side of the cleaner. When the filter becomes dirty, open the door, remove the filter and replace. The white, pleated HEPA Media Filter is not washable.

**Note: A basic washable Post-Motor Filter with reduced filtration is available if desired.**

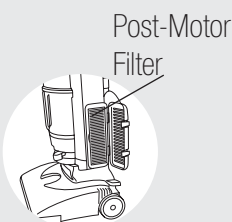

### Check Rotating Floor Brush and Drive Belt

You should check your vacuum cleaner's Rotating Floor Brush and Drive Belt regularly for wear or damage. You should also clean the brush and brush ends of strings, hair, and carpet fibers. These can wrap around the brush and hamper its ability to effectively clean your carpet. Also remove any debris that has accumulated under the brush cover.

1. Unplug cleaner from electrical outlet.
2. Place handle in Low position and turn vacuum cleaner over so bottom side is up.

## Check Rotating Floor Brush and Drive Belt Continued

3. For **standard models**, remove the four screws as shown with a Phillips Head Screwdriver. Lift the Brush Cover off.  
**For wide cleaning path models**, Lift tab 1 and release the three latches in order 2-4 as marked. Lift the Brush Cover off.
4. Grasp Rotating Floor Brush at both ends and lift.
5. Clean strings, hair and other debris from Rotating Floor Brush, paying particular attention to brush ends.
6. Clean strings, hair and other debris from Motor Pulley and Drive Belt areas.
7. Check Drive Belt carefully for wear, cuts or stressed areas.
8. Check Air Passageway for obstructions. Remove debris from this area.

## Replace Drive Belt

Use only BISELL Style 9 Replacement Belts (#32074) in your BISELL CleanView II.

1. Unplug cleaner from electrical outlet.
2. With Rotating Floor Brush removed from vacuum cleaner (Steps 1-4 of Check Rotating Floor Brush and Drive Belt), grasp old Drive Belt and remove from Motor Pulley. Discard old Drive Belt.
3. Place new Drive Belt over Motor Pulley and stretch other end over Rotating Floor Brush in the space between the bristles.
4. Place ends of Rotating Floor Brush down into slots on sides as shown.
5. Turn Rotating Floor Brush by hand several times in the direction of Motor Pulley. If properly installed, Drive Belt will center itself on Rotating Brush.
6. Reposition Brush Cover and screw or snap back into place. Check to be sure all screws or latches are secured.

## Replace Lightbulb

Use only BISELL Replacement Bulbs in your BISELL CleanView II.

1. Unplug cleaner from electrical outlet
2. Using a flat screwdriver, table knife or coin, insert into the slot on the right of the lens and gently push inner latch to the left as shown to remove the lens.

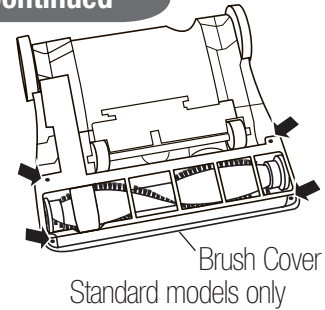

Standard models only

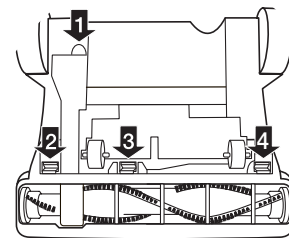

Wide Cleaning Path models only

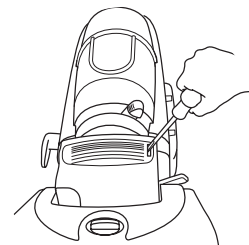
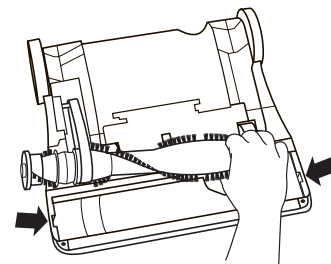
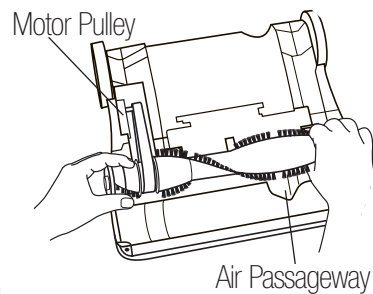

## Replace Lightbulb Continued

3. Determine the light bulb type of your vacuum:  
Standard Bulb (#203-1297) – approximately 1" long, flat end  
Large Bulb (#203-1007) – approximately 2" long, round end
4. **Standard Bulb** – remove the bulb from the socket by grasping bulb and pulling straight out. Install the new bulb by pushing it gently into the socket until the bulb snaps into place.  
**Large Bulb** - remove the bulb from the socket by pushing bulb in gently and turning it towards brush. Install the new bulb by pushing it gently into the socket and turning away from the brush.
5. Reposition lens by inserting the tab on left side and then pushing the right side back into place.

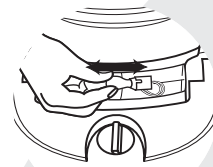

Standard Bulb

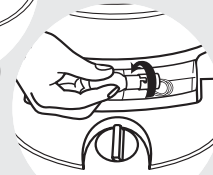

Large Bulb

## TurboBrush Maintenance

### Select Models Only

The TurboBrush should be checked regularly for clogs or debris wrapping around the brush roll.

1. Unplug vacuum from electrical outlet.
2. If a clog is present or debris is visible, unscrew the two screws on the back of the TurboBrush to remove the faceplate and clear any obstructions.
3. To clean debris from the brush roll, remove the screw located on the belt cover. Lift the belt cover. Remove the brush roll from the drive belt and clean debris.
4. Reposition the drive belt on the brush roll. Place ends of brush roll in slots on sides as shown. Reposition belt cover and secure with shorter screw. Reposition faceplate and secure with two longer screws.

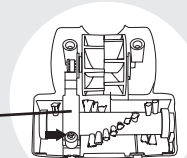
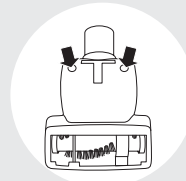

Belt Cover

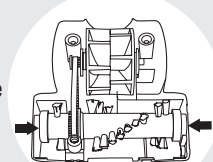

## Clearing Clogs

Low suction, poor pickup, or no suction may be due to a clog in the vacuum cleaner. If you notice a change in the sound of the motor or a reduction in the spinning action in the Dirt Container, check for clogs.

1. Unplug cleaner from electrical outlet.
2. Empty Dirt Container.

### Clearing Clogs Continued

3. Check Upper Tank and Louvers for build up or clogs. Check to make sure Louvers are installed correctly. To unlock the Louvers, grasp the rim and turn toward the left. Pull straight down to remove. If the Louvers are missing or not locked into place, check and clear the tube in the center of the Dirt Container.
4. Remove the Twist 'n Snap Hose from the vacuum by turning to the left. Check the Suction Inlet, Hose and Hose Wand for clogs. Remove any clogs from the hose using a long, narrow object.
5. Check the Foot Hose for clogs. If needed, remove the screw attaching the Hose Wand Base to the vacuum. Straighten the Foot Hose and unclog with a long, narrow object.
6. If the clog persists, follow the instructions for Checking the Rotating Floor Brush on page 9-10 and inspect the Air Passageway for obstructions.

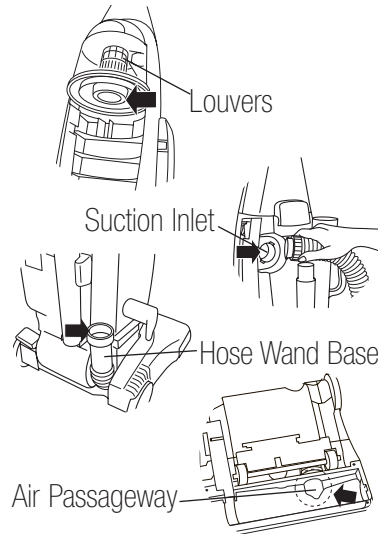

### Troubleshooting



### WARNING:

To reduce the risk of injury from moving parts and/ or electrical shock, turn Power Switch OFF and disconnect polarized plug from electrical outlet before performing troubleshooting checks.

### Vacuum cleaner won't run

#### Possible Causes

- 1 Power cord not plugged in
- 2 Blown fuse/tripped breaker

#### Remedies

- 1 Check electrical plug
- 2 Check/Replace fuse or reset breaker

### Vacuum cleaner won't pick up dirt

#### Possible Causes

- 1 Incorrect Height Adjustment
- 2 Hose not attached to suction opening
- 3 Twist 'n Snap Hose not securely attached.
- 4 Crack or hole in Hose
- 5 Broken or worn Drive Belt
- 6 Rotating Floor Brush bristles worn
- 7 Rotating Floor Brush jammed
- 8 Clog in vacuum
- 9 Dirt Container full

#### Remedies

- 1 Adjust Powerfoot to correct height setting
- 2 Grasp Quick Reach Handle and firmly push Hose Wand onto the suction opening
- 3 Make sure Twist 'n Snap Hose is snapped into locked position
- 4 Check Hose and replace if needed
- 5 Replace Drive Belt, see pg. 9-10
- 6 Replace brush
- 7 Remove brush and clean debris from brush ends
- 8 Clear clog, see pg. 11-12
- 9 Empty Dirt Container

## Troubleshooting Continued

### Vacuum cleaner won't pick up dirt continued

#### Possible Causes

- ⑩ Dirt Container not installed properly
- ⑪ Filters are dirty
  
- ⑫ Louvers missing or installed incorrectly

#### Remedies

- ⑩ Position correctly and lock in place
- ⑪ Check and clean Inner and Outer Circular Filters, Pre-Motor and Post-Motor Filters
- ⑫ Check for a clog in the tube in the center of the Dirt Container, clear and properly install Louvers

### Tools won't pick up dirt

#### Possible Cause

- ① Crack or hole in Hose
- ② Clog in vacuum
- ③ Dirt Container full
- ④ Dirt Container or Upper Tank not installed properly
- ⑤ Filters are dirty
  
- ⑥ Louver missing or installed incorrectly

#### Remedies

- ① Check Hose and replace if needed
- ② Clear clog, see pg. 11-12
- ③ Empty Dirt Container
- ④ Position correctly and lock in place
- ⑤ Check and clean Inner and Outer Circular filters, Pre-Motor and Post-Motor Filters
- ⑥ Check for a clog in the tube in the center of the Dirt Container, clear and properly install Louvers

### Vacuum cleaner is difficult to push

#### Possible Causes

- ① Incorrect Height Adjustment
- ② Brush Cover installed incorrectly

#### Remedies

- ① Adjust Powerfoot to correct height setting
- ② Make sure all four screws are in place or all three latches are secured

### Visible dirt escaping from cleaner

#### Possible Causes

- ① Dirt Container full
- ② Filters missing or installed incorrectly
  
- ③ Dirt Container installed incorrectly
- ④ Filter Cup installed incorrectly

#### Remedies

- ① Empty Dirt Container
- ② Check Inner and Outer Circular Filters and Post-Motor Filter for correct installation
- ③ Pull out and re-insert Dirt Container correctly
- ④ Remove Dirt Container and make sure Filter Cup is fully attached

If suggested solutions do not correct the problem, call:  
**BISSELL Consumer Services**

## Replacement Parts – BISSELL Cleanview II Series

You may purchase replacement parts from your retailer, by calling BISSELL Consumer Services or by visiting our website. To locate a retailer near you, or to place an order using Visa, MasterCard, Discover or American Express, call

### BISSELL Consumer Services

**1-800-237-7691**

Monday - Friday 8 a.m. — 10 p.m. ET

Saturday 9 a.m. — 8 p.m. ET

Or visit our Website - [www.bissell.com](http://www.bissell.com)

Item	Part No.	Part Name
1	32074	Style 7/9/10 Drive Belt (2-Pack)
2	203-1007	Large Headlight Bulb (Select Models Only)
3	203-1297	Standard Headlight Bulb (Select Models Only)
4	203-1063	Crevice Tool
5	203-1099	Combination Dusting Brush / Upholstery Tool
6	203-1084	Extension Wand
7	203-1227	TurboBrush (Select Models Only)
8	203-1220	Wire Reinforced Twist 'n Snap Vacuum Hose Gray
9	203-1221	Wire Reinforced Twist 'n Snap Vacuum Hose Clear
10	203-2032	Brush Roll
11	203-1195	Wide Brush Roll (Select Models Only)
12	32064	Style 9/10 Inner & Outer Circular Filter Set
13	32065	Style 9/10 Inner Circular Filter only
14	203-1192	Style 9/10 Outer Circular Filter only
15	203-1215	Style 9/10 Pre-Motor Filter
16	3099	Style 7/9 Post-Motor Filter (2 pack)
17	32076	Style 7/9 HEPA Media Post-Motor Filter (Select Models Only)

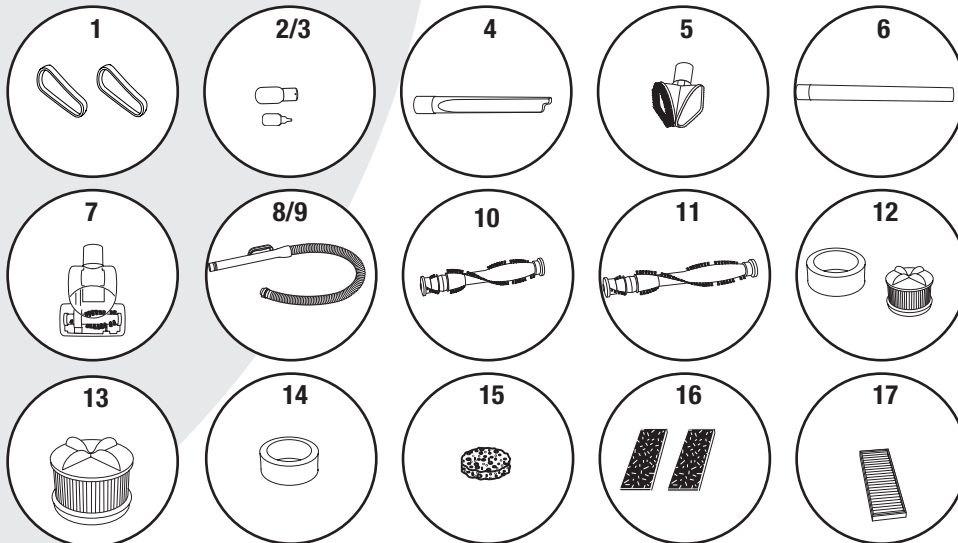



## BISSELL Consumer Services

For information about repairs or replacement parts, or questions about your warranty, call:

### **BISSELL Consumer Services**

**1-800-237-7691**

Monday - Friday      8 a.m. — 10 p.m. ET

Saturday              9 a.m. — 8 p.m. ET

Or write:

BISSELL Homecare Inc.  
PO Box 3606  
Grand Rapids, MI 49501  
ATTN: Consumer Services

Or visit the BISSELL website - **[www.bissell.com](http://www.bissell.com)**

When contacting BISSELL, have model number of unit available.

Please record your Model Number: \_\_\_\_\_

Please record your Purchase Date: \_\_\_\_\_

**NOTE: Please keep your original sales receipt. It is your warranty.**

## Warranty

This warranty gives you specific legal rights, and you may also have other rights which may vary from state to state. If you need additional instruction regarding this warranty or have questions regarding what it may cover, please contact BISSELL Consumer Services by E-mail, telephone, or regular mail as described below.

### Limited One Year Warranty

Subject to the \*EXCEPTIONS AND EXCLUSIONS identified below, upon receipt of the product BISSELL Homecare Inc. will repair or replace (with new or remanufactured components or products), at BISSELL's option, free of charge from the date of purchase by the original purchaser, for one year any defective or malfunctioning part.

See information below on "If your BISSELL product should require service".

This warranty applies to product used for personal, and not commercial or rental service. This warranty does not apply to fans or routine maintenance components such as filters, belts, or brushes. Damage or malfunction caused by negligence, abuse, neglect, unauthorized repair, or any other use not in accordance with the User's Guide is not covered.

#### If your BISSELL product should require service:

Contact BISSELL Consumer Services to locate a BISSELL Authorized Service Center in your area.

If you need information about repairs or replacement parts, or if you have questions about your warranty, contact BISSELL Consumer Services.

**Website or E-mail:**

[www.bissell.com](http://www.bissell.com)

Use the "Customer Services" tab.

**Or Call:**

BISSELL Consumer Services

1-800-237-7691

Monday - Friday 8 a.m. - 10 p.m. ET

Saturday 9 a.m. - 8 p.m. ET

**Or write:**

BISSELL Homecare Inc.

PO Box 3606

Grand Rapids MI 49501

ATTN: Consumer Services

**BISSELL HOMECARE INC. IS NOT LIABLE FOR INCIDENTAL OR CONSEQUENTIAL DAMAGES OF ANY NATURE ASSOCIATED WITH THE USE OF THIS PRODUCT. BISSELL'S LIABILITY WILL NOT EXCEED THE PURCHASE PRICE OF THE PRODUCT.**

Some states do not allow the exclusion or limitation of incidental or consequential damages, so the above limitation or exclusion may not apply to you.

**\*EXCEPTIONS AND EXCLUSIONS FROM THE TERMS OF THE LIMITED WARRANTY**

**THIS WARRANTY IS EXCLUSIVE AND IN LIEU OF ANY OTHER WARRANTIES EITHER ORAL OR WRITTEN. ANY IMPLIED WARRANTIES WHICH MAY ARISE BY OPERATION OF LAW, INCLUDING THE IMPLIED WARRANTIES OF MERCHANTABILITY AND FITNESS FOR A PARTICULAR PURPOSE, ARE LIMITED TO THE ONE YEAR DURATION FROM THE DATE OF PURCHASE AS DESCRIBED ABOVE.**

Some states do not allow limitations on how long an implied warranty lasts, so the above limitation may not apply to you.

16



©2005 BISSELL Homecare Inc.  
Grand Rapids, Michigan  
All rights reserved. Printed in Korea  
Part Number 603-2559  
Rev 10/05  
Visit our website at:  
[www.bissell.com](http://www.bissell.com)