

Shark™ **Roadster**

OWNER'S MANUAL

Model EP722
120V., 60Hz., 10.8 Amps



For information or assistance:
EURO-PRO Operating LLC
94 Main Mill Street, Door 16
Plattsburgh, NY 12901
www.sharkvac.com

EURO-PRO 

IMPORTANT SAFETY INSTRUCTIONS

When using your vacuum cleaner, basic safety precautions should always be observed, including the following:

1. Read all instructions before using your canister vacuum.
2. Use the system only for its intended use.
3. To protect against a risk of electric shock, do not immerse any part of the system in water or other liquids.
4. Never yank cord to disconnect from outlet; instead, grasp plug and pull to disconnect.
5. **Do not** allow cord to touch hot surfaces.
6. **Do not** run appliance over cord.
7. **Do not** operate the system with a damaged cord or plug, or if the appliance or any other part of the system has been dropped or damaged. To avoid the risk of electric shock, do not disassemble or attempt to repair the canister vacuum. Return the system to **EURO-PRO** Corporation (see warranty) for examination and repair. Incorrect re-assembly or repair can cause a risk of electrical shock or injury to persons when the canister vacuum is used.
8. Close supervision is necessary for any appliance being used by or near children. Do not leave the system unattended while connected.
9. Keep hair, loose clothing, fingers and all parts of body away from opening and moving parts.
10. **Do not** use to pick up flammable or combustible liquids such as gasoline or use in areas where they may be present.
11. **Do not** pick up anything that is burning or smoking such as cigarettes, matches or hot ashes.
12. Use extra care when cleaning on stairs.
13. **Do not** use the canister vacuum without the dust bag and/or filters in place.
14. **Do not** pick up hard or sharp objects such as glass, nails, screws, coins, etc.
15. This appliance is intended only for household use. Follow all user instructions in this manual.

To reduce the risk of fire, electric shock, or injury:

- **Do not** leave the canister vacuum plugged in when unattended. Unplug the electrical cord when not in use and before servicing.
- **Do not** allow to be used as a toy. Close attention is necessary when used by or near children, pets or plants.
- Use only as described in this manual. Use only manufacturer's recommended accessories.
- **Do not** pull cord, use cord as a handle, close a door on cord, or pull cord around sharp edges or corners. Keep cord away from heated surfaces.
- Use **only** extension cords UL-rated or cUL at 15 amperes. extension cords rated for less amperage may overheat. Care should be taken to arrange the cord so that the cord cannot be pulled or tripped over.
- Turn off all controls as applicable before unplugging from electrical outlet.
- **Do not** unplug by pulling on cord. To unplug, grasp the plug, not the cord.
- **Do not** handle plug or vacuum with wet hands or operate without shoes.
- **Do not** put any objects into openings. Do not use with any opening blocked. Keep free of dust, lint, hair and anything else that may reduce air flow.
- Store your appliance indoors in a cool, dry area.
- Keep your work area well lit.
- **Do not** immerse the vacuum into water or other liquids.
- Keep end of hose, wands and other openings away from your face and body.
- Use only on dry surfaces.
- Using improper voltage may result in damage to the motor and possible injury to the user. Correct voltage is listed on rating label.

SAVE THESE INSTRUCTIONS

For Household Use Only

WARNING: To reduce the risk of electric shock, this appliance has a polarized plug (one blade is wider than the other). This plug will fit in a polarized outlet only one way. If the plug does not fit fully in the outlet, reverse the plug. If it still does not fit, contact a qualified electrician to install the proper outlet. Do not modify the plug in any way.



ONE (1) YEAR LIMITED WARRANTY

Euro-Pro Operating LLC warrants this product to be free from defects in material and workmanship for a period of one (1) year from the date of the original purchase, when utilized for normal household use, subject to the following conditions, exclusions and exceptions.

If your appliance fails to operate properly while in use under normal household conditions within the warranty period, return the complete appliance and accessories, freight prepaid to **Euro-Pro Operating LLC**, 94 Main Mill Street, Door 16, Plattsburgh, NY 12901. If the appliance is found by **EURO-PRO** to be defective in material or workmanship, **EURO-PRO** will repair or replace it free of charge. Proof of purchase date and \$ 9.95 to cover the cost of return shipping and handling must be included. *

Non-durable parts including, without limitation, dust bags, filters, brushes and electrical parts which normally require replacement are specifically excluded from warranty.

The liability of **Euro-Pro Operating LLC** is limited solely to the cost of the repair or replacement of the unit at our option. This warranty does not cover normal wear of parts and does not apply to any unit that has been tampered with or used for commercial purposes. This limited warranty does not cover damage caused by misuse, abuse, negligent handling or damage due to faulty packaging or mishandling in transit. This warranty does not cover damage or defects caused by or resulting from damages from shipping or repairs, service or alterations to the product or any of its parts, which have been performed by a repair person not authorized by **EURO-PRO**.

This warranty is extended to the original purchaser of the unit and excludes all other legal and/or conventional warranties. The responsibility of **Euro-Pro Operating LLC** if any, is limited to the specific obligations expressly assumed by it under the terms of the limited warranty. **In no event** is **Euro-Pro Operating LLC** liable for incidental or consequential damages of any nature whatsoever. Some states do not permit the exclusion or limitation of incidental or consequential damages, so the above may not apply to you.

This warranty gives you specific legal rights, and you may also have other rights which vary from state to state.

***Important: Carefully pack item to avoid damage in shipping. Be sure to include proof of purchase date and to attach tag to item before packing with your name, complete address and phone number with a note giving purchase information, model number and what you believe is the problem with item. We recommend you insure the package (as damage in shipping is not covered by your warranty). Mark the outside of your package "ATTENTION CUSTOMER SERVICE".**

We are constantly striving to improve our products, therefore the specifications contained herein are subject to change without notice.



OWNERSHIP REGISTRATION CARD

Please fill out and mail the product registration card within ten (10) days of purchase. The registration will enable us to contact you in the unlikely event of a product safety notification. By returning this card you acknowledge to have read and understood the instructions for use, and warnings set forth in the accompanying instructions.

RETURN TO Euro-Pro Operating LLC: 94 Main Mill Street, Door 16, Plattsburgh, NY 12919
Model EP722

Appliance model _____

Date purchased _____ Name of store _____

Owner's name _____

Address _____ City _____ State _____ Zip code _____

FOR REPLACEMENT FILTER INFORMATION for Model EP722

Call: 1-866-98SHARK (1-866-987-4275)

Monday to Friday 8:30 A.M. - 5:00 P.M. Eastern Standard Time
or

visit our website: www.sharkvac.com

Replacement HEPA filter SKU# XSH722

FOR TECHNICAL SUPPORT for Model EP722

In U.S.: 1 (866) 805-6850

Monday to Friday 8:30 A.M. - 5:00 P.M. Eastern Standard Time

Please Note:

The HEPA Dust Cup Filter may be washed. We recommend that this be done once a month or when suction appears reduced.

To wash your HEPA Dust Cup Filter, hold filter cartridge by frame flange, flange side up and rinse under water. When finished, shake off excess water. Do **NOT** wash in dishwasher.

It is important that when you wash the HEPA dust cup filter, you allow it to air dry **COMPLETELY** before using again. We recommend 24 hours to air dry. **DO NOT DRY IN DRYER.**

IMPORTANT: Both the Pre-Motor and the Micro Exhaust filters should be replaced every 6 months or sooner if required.

All filters should be checked regularly for signs of damage, preferable after each cleaning task. The filters must be replaced immediately if they become damaged. Always disconnect the vacuum from the electrical outlet when checking the filters.

Important:

This vacuum cleaner is equipped with a motor protective thermostat. If for some reason your vacuum overheats, the thermostat will automatically turn the unit off. Should this occur, unplug the vacuum from the wall outlet and turn off the switch. Empty the dust cup, "TapClean" the dust cup filter and check for blockages in hose and suction inlet. Allow the unit to cool for a minimum of 45 minutes prior to restarting the unit. To restart, re-plug the vacuum into the wall socket and turn the switch back on.

GETTING TO KNOW YOUR VACUUM

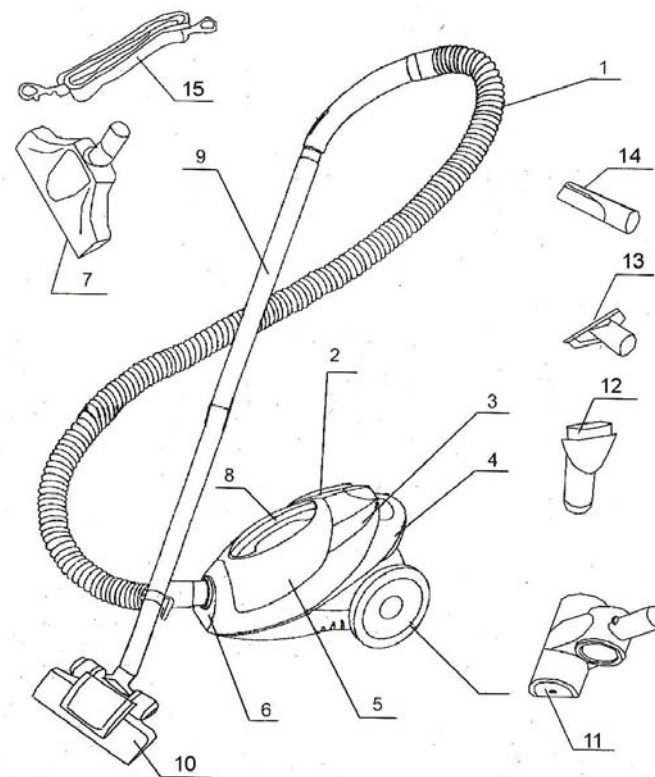

- | | |
|---------------------------|--------------------------------------|
| 1. Hose | 9. Telescopic Tube |
| 2. Cord Rewind Button | 10. Floor to Carpet Brush |
| 3. Power On/off Button | 11. Hand Held Air Driven Turbo Brush |
| 4. Handle | 12. Upholstery Brush |
| 5. Dust Cup | 13. Dusting Brush |
| 6. Air Intake Duct | 14. Crevice Tool |
| 7. Air Driven Turbo Brush | 15. Shoulder Strap |
| 8. Dust Cup Handle | |

Technical Specifications

Voltage: 120V., 60Hz.
Power: 10.8 Amps, 1300 Watts

PRECAUTIONARY MEASURES

Important: If the suction opening of the unit, the hose or the chrome telescopic tube are **BLOCKED**, switch off the vacuum cleaner and remove the blocking substance before you start the unit again.

1. Do not operate the vacuum cleaner too close to heaters or radiators.

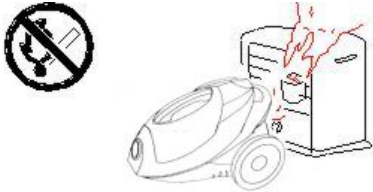

2. Before inserting the power plug into the wall outlet, make sure that your hands are dry.

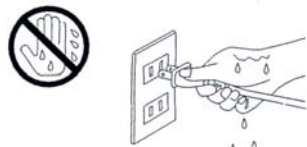

3. Before you start vacuuming, make sure to remove large or sharp objects that might damage the dust bag.

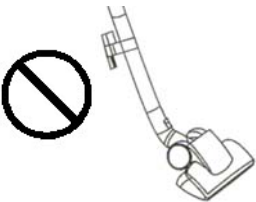

4. When pulling out the power plug from the wall outlet, pull the plug not the power cord.

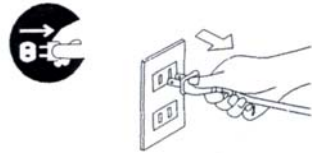

5. Do not pick up anything that is burning or smoking such as cigarettes, matches or hot ashes.
6. Do not use without all filters in place.

Note: This vacuum cleaner is equipped with a plug and power cord that retract automatically. If the cord or plug get damaged, it must be replaced by a qualified technician.

Warning: Hold the plug when rewinding the cord. Do not allow the cord to whip when rewinding.

OPERATING INSTRUCTIONS

Motor Thermostat

Important: This vacuum cleaner is equipped with a motor protective thermostat. If for some reason your vacuum overheats, the thermostat will automatically turn the unit off. Should this occur, unplug the vacuum from the wall outlet and turn off the switch. Empty the dust cup, "TapClean" the dust cup filter and check for blockages in hose and suction inlet. Allow the unit to cool for a minimum of 45 minutes prior to restarting the unit. To restart, re-plug the vacuum into the wall socket and turn the switch back on.

Attaching the Shoulder Strap

Use the hooks to attach the shoulder strap to the vacuum cleaner.

First pass the flexible hose through the loop of the shoulder strap and then attach the two hooks to the strap hookup holes at the bottom of the vacuum cleaner as shown in illustration below.

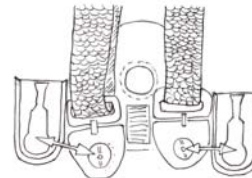

Flat & Upright Parking Position

Please note that your vacuum cleaner can be conveniently placed in a space saving vertical parking position or in a convenient flat parking position.

1. Place unit on its side. Slide floor nozzle into locking position with receptacle which rests on top of unit.
2. While laying flat on 3 wheels, slide floor nozzle into locking position with receptacle which rests on the rear side of the unit.



OPERATING INSTRUCTIONS

9. Reassemble the debris screen to the HEPA filter cartridge and replace into dust cup (container). Ensure that the filter assembly is completely seated inside the dust cup (container).

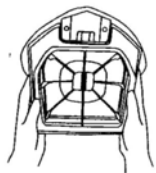

10. Attach the dust cup (container) to the vacuum.

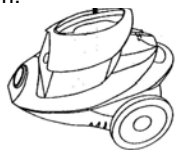

PLEASE NOTE: The white pleated filter material in the HEPA Dust Cup Filter will discolor over time -This is NORMAL and will NOT affect the performance of the filter. If the HEPA Dust Cup Filter is properly "TapCleaned" after each use and suction does not return to 100%, then we suggest that the HEPA filter be "TapCleaned" vigorously until no

more dust can be removed, then rinsed under the faucet and allowed to dry for 24 hours before refitting into the vacuum. (Fig. A) **This should be done once a month or when suction appears to be reduced.**

CAUTION: The suction hole must be open, free of any obstructions at all times. Otherwise, the motor will overheat and could become damaged.

Important: Do NOT use the HEPA filter cartridge without the debris screen in place.

Changing the Pre-Motor Filter

- Filter should be cleaned at least twice a year or when it becomes visibly solid.
- Always operate the cleaner with the filter installed.
- Disconnect from electrical outlet before cleaning the filter.

1. Lift dust cup handle to remove dust cup.
2. Remove the filter from the filter grill.

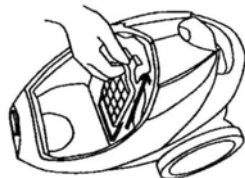

3. Replace with a new filter and reinstall in vacuum.

Changing the Micro-Exhaust Filter

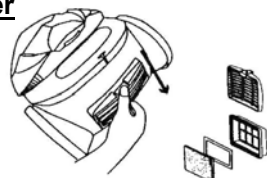

1. Remove the exhaust filter grill by pulling the locking tabs towards you.
2. Remove the used micro-exhaust filter.
3. Insert a new micro-exhaust filter and replace the filter grill.

IMPORTANT: Both the Pre-Motor and the Micro Exhaust filters should be replaced every 6 months or sooner if required.

IMPORTANT: All filters should be checked regularly for signs of damage, preferable after each cleaning task. The filters must be replaced immediately if they become damaged.

Always disconnect the vacuum from the electrical outlet when checking the filters.

OPERATING INSTRUCTIONS

Assembling Your Vacuum Cleaner

Note: Always remove the power plug from the wall outlet before assembling or removing accessories.

1. Attaching the Flexible Hose into the Vacuum

Connect the flexible hose into the air intake duct. Push in until you hear a "click", indicating it is in its locked position.

To remove the flexible hose reverse the operation.

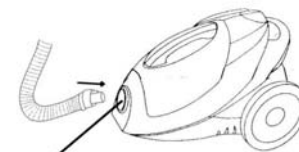

Air Intake Duct

2. Fitting the Telescopic Tube to the Curved Wand / Hose Extension

Push the telescopic tube into the curved wand / hose extension, as shown in the illustration below.

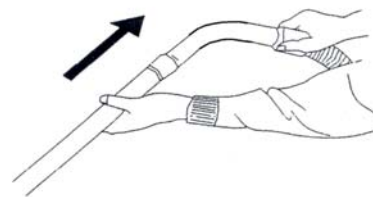

3. Extending the Chrome Telescopic Tube

Push forward on the plastic button and pull the inner chrome tube outward.

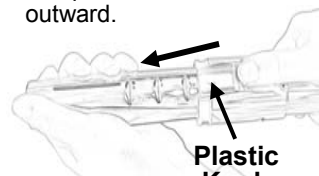

Plastic Knob

4. Fitting the Floor to Carpet Brush or the Air Driven Turbo Brush to the Telescopic Tube

Push the telescopic tube into the desired floor brush as show in the illustration below.

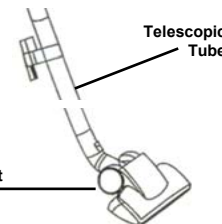

Floor to Carpet Nozzle

5. Air Driven Turbo Brush

The efficiency of your Air Driven Turbo Brush depends on the bristle brush rotating at high speed. Strong air suction is needed to accomplish this. In order to endure that maximum air suction is maintained, please read the following instructions:

- Empty the Dust Cup frequently during use.
- Always "TapClean" the HEPA dust cup filter and debris screen each time the dust cup is emptied.
- Ensure that the rotating bristle brush is kept free of hair and string.
- Inspect the turbine regularly to ensure that the air passage is free of dirt and debris.

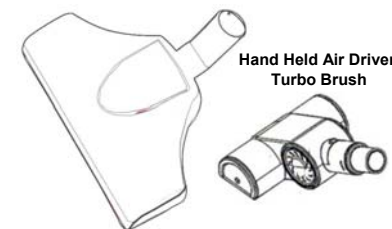

Air Driven Turbo Brush

Hand Held Air Driven Turbo Brush

Crevice Tool, Upholstery and Dusting Brush

1. Crevice Tool

For radiators, crevices, corners, baseboards and between cushions.



2. Dusting Brush

The dusting brush is used for the furniture, venetian blinds, books, lamp shades and shelves.



3. Upholstery Brush

The dusting brush is used for the furniture.



Warning: To reduce the risk of electric shock, the power cord must be disconnected before removing the dust cup, dust cup filter, changing the filters or performing maintenance/trouble shooting checks.

Note: Before using the appliance, unwind a sufficient length of cable and insert the plug into the wall socket. A yellow mark on the power cord shows the ideal cable length. Don't pull the power cord beyond the red mark.

Power Cord

Your vacuum cleaner includes a power cord, which is automatically retractable. To extend your power cord, pull from rear and extend to desired length. When cleaning is finished, first switch off power and disconnect plug from electrical outlet. Then press on cord rewind button. If the cord does not fully retract, pull it out again and then press on cord rewind button.

1. Insert the power plug into the wall outlet.
2. Press the Power On/Off Switch to activate the vacuum cleaner.

Power On/Off Button

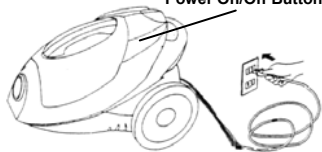

3. To rewind the power cord, press the cable rewind button with one hand and guide the power cord with the other hand to ensure that it does not whip causing damage.

Cord Rewind

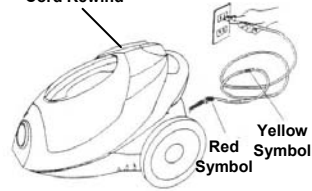

Warning: Hold the plug when rewinding the cord. Do not allow the cord to whip when rewinding.

Cleaning Air Driven Turbo Brush

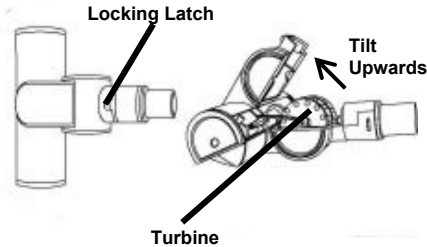

1. Slide locking latch forward then tilt the top housing of the brush upwards. The top housing is hinged and will tilt up approximately 45° only.
2. Inspect turbine wheel and air passage for debris and/or blockage. Remove debris if present.
3. Inspect the rotating brush for built-up hair or string. If present, remove by carefully cutting with scissors. Avoid damaging or cutting bristles.
4. Once clean, close the top cover of the turbo brush and slide the locking latch toward the rear of the brush to lock.

Cleaning & Changing the HEPA Dust Cup Filter

Warning: Always unplug the unit from electrical outlet before opening the Dust Cup (container).

Important: Do **NOT** use the HEPA filter cartridge without the debris screen in place.

Warning: After each Use - Always remove the Filter Debris Screen from the HEPA Dust Cup Filter, then vigorously "TapClean" HEPA Filter until no more dust can be removed.

IMPORTANT, Please Note : The "TapClean" HEPA Dust Cup Filter & Debris Screen will stop most of the tiniest dust particles and airborne allergens from re-entering the air you breathe. In fact it stops 99.97% of all particles as small as 0.3 microns - many times smaller than a human hair!!! Because of this incredible filtration performance, the HEPA Dust Cup Filter will quickly accumulate, inside the white filter folds, many fine dust particles that are difficult to see but which will eventually block or reduce your suction power - if not cleaned properly. This can cause the motor to overheat and the re-settable thermostat to trip. (Should this happen turn off the switch, unplug the unit and allow unit to cool down. Clean the HEPA Filter and Debris Screen as described in this section, then reconnect unit and proceed with vacuuming.)

1. Push the Power On/Off switch to the OFF position to disconnect the power.
2. Remove the flexible hose.
3. Remove the dust cup by lifting the dust cup handle. See illustration below.

Dust Cup Handle



4. Take the HEPA dust cup filter out of the dust cup, do not let dust fall out of dust cup.

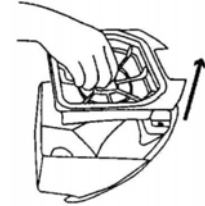

5. Take the dust cup and dispose of the dust inside.



6. Separate the debris screen from the HEPA filter cartridge by grasping the debris screen with one hand and the filter frame with the other and pull apart.

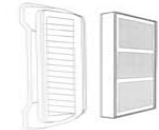

HEPA Filter Debris Screen

7. Vigorously "TapClean" the HEPA Dust Cup Filter on a hard surface until no more dust is observed falling out from between the pleats of the filter. Please note that on the under side of the HEPA dust cup filter there is a small brush which you can use to brush out the pleats of the filter.



8. "TapClean" the Debris Screen or rinse under a faucet until clean. Remember that the Debris Screen must be completely dry before reinstalling in the vacuum.

