

SAMSUNG

MICROWAVE OVEN

Owner's Instructions

M1734NCE / M1735NCE
M1713NCE

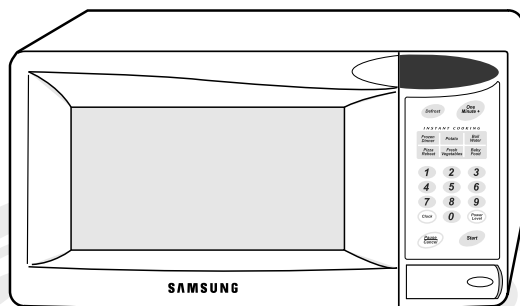

Oven.....	2
Accessories.....	2
Control Panel.....	3
Using this Instruction Booklet.....	4
Safety Precautions.....	4
Installing Your Microwave oven.....	6
Setting the Time (M1734NCE/M1735NCE).....	6
What to Do if You are in Doubt or Have a Problem.....	7
Cooking / Reheating.....	7
Power Levels.....	8
Using the Pause/Cancel Button (M1734NCE/M1735NCE).....	8
Stopping the Cooking (M1713NCE).....	8
Using the One Minute+ Button (M1734NCE/M1735NCE).....	9
Adjusting the Cooking Time (M1713NCE).....	9
Using the Instant Cooking Feature.....	9
Instant Cooking Settings.....	10
Manual Defrost Food.....	11
Manual Defrosting Guide.....	11
Defrost Guide (Continued).....	12
Multistage Cooking (M1734NCE/M1735NCE).....	12
Cookware Guide.....	13
Cleaning Your Microwave Oven.....	14
Technical Specifications.....	14

Oven

GB

Model: M1734NCE/ M1735NCE

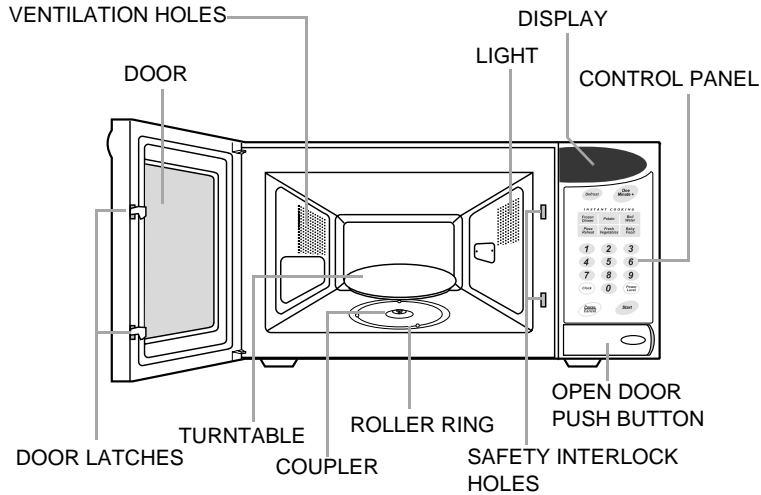

Model: M1713NCE

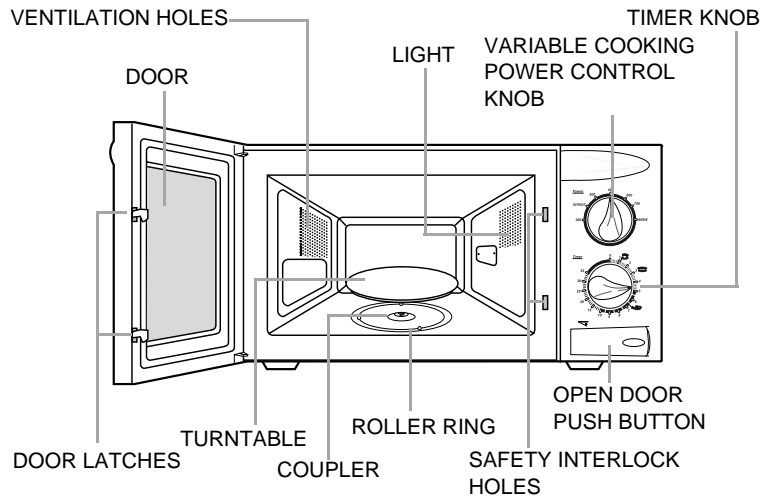

Accessories

Depending on the model that you have purchased, you are supplied with several accessories that can be used in a variety of ways.

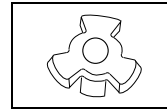

1. **Coupler**, already placed over the motor shaft in the base of the oven.

Purpose: The coupler rotates the turntable.

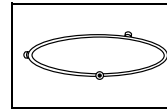

2. **Roller ring**, to be placed in the centre of the oven.

Purpose: The roller ring supports the turntable.

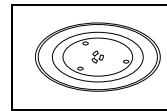

3. **Turntable**, to be placed on the roller ring with the centre fitting to the coupler.

Purpose: The turntable serves as the main cooking surface; it can be easily removed for cleaning.



DO NOT operate the microwave oven without the roller ring and turntable.

Control Panel

Model: M1734NCE / M1735NCE

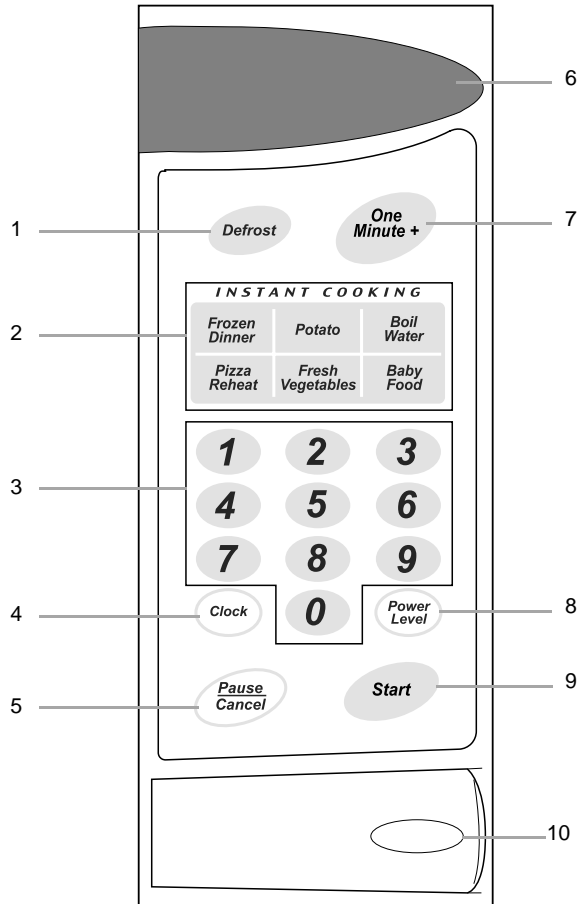

Model: M1713NCE

GB

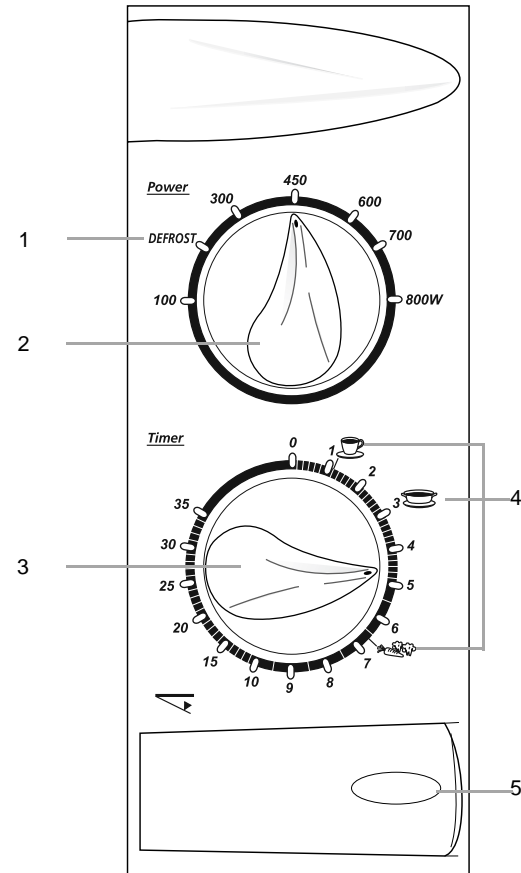

- | | |
|-------------------------------------|---------------------------|
| 1. MANUAL DEFROST FEATURE SELECTION | 6. DISPLAY |
| 2. INSTANT COOK SELECTION | 7. ONE MINUTE + BUTTON |
| 3. NUMBER BUTTONS | 8. POWER LEVEL BUTTON |
| 4. CLOCK SETTING BUTTON | 9. START BUTTON |
| 5. PAUSE / CANCEL BUTTON | 10. OPEN DOOR PUSH BUTTON |

1. DEFROST
2. VARIABLE COOKING POWER CONTROL KNOB
3. TIMER KNOB
4. INSTANT REHEAT
5. OPEN DOOR PUSH BUTTON

Using this Instruction Booklet

GB

You have just purchased a SAMSUNG microwave oven. Your Owner's Instructions contain much valuable information on cooking with your microwave oven:

- Safety precautions
- Suitable accessories and cookware
- Useful cooking tips

At the front of the booklet you will find illustrations of the oven, and more importantly the control panel, so that you can find the buttons more easily.

The step-by-step procedures use two different symbols.



Important



Note

PRECAUTIONS TO AVOID POSSIBLE EXPOSURE TO EXCESSIVE MICROWAVE ENERGY

Failure to observe the following safety precautions may result in harmful exposure to microwave energy.

- Under no circumstances should any attempt be made to operate the oven with the door open or to tamper with the safety interlocks (door latches) or to insert anything into the safety interlock holes.
- Do not place any object between the oven door and front face or allow food or cleaner residues to accumulate on sealing surfaces. Ensure that the door and door sealing surfaces are kept clean by wiping after use first with a damp cloth and then with a soft dry cloth.
- Do not operate the oven if it is damaged until it has been repaired by a qualified microwave service technician trained by the manufacturer. It is particularly important that the oven door closes properly and that there is no damage to the:
 - Door, door seals and sealing surfaces
 - Door hinges (broken or loose)
 - Power cable
- The oven should not be adjusted or repaired by anyone other than a properly qualified microwave service technician trained by the manufacturer.

Safety Precautions

Important Safety Instructions.

Read Carefully and keep for future reference.

Before cooking food or liquids in your microwave oven, please check that the following safety precautions are taken.

- DO NOT** use any metallic cookware in the microwave oven:
 - Metallic containers
 - Dinnerware with gold or silver trimmings
 - Skewers, forks, etc.

Reason: Electric arcing or sparking may occur and may damage the oven.
- DO NOT** heat:
 - Airtight or vacuum-sealed bottles, jars, containers
Ex) Baby food jars
 - Airtight food.
Ex) Eggs, nuts in shells, tomatoes

Reason: The increase in pressure may cause them to explode.
Tip: Remove lids and pierce skins, bags, etc.
- DO NOT** operate the microwave oven when it is empty.
Reason: The oven walls may be damaged.
Tip: Leave a glass of water inside the oven at all times.
The water will absorb the microwaves if you accidentally set the oven going when it is empty.
- DO NOT** cover the rear ventilation slots with cloths or paper.
Reason: The cloths or paper may catch fire as hot air is evacuated from the oven.
- ALWAYS** use oven gloves when removing a dish from the oven.
Reason: Some dishes absorb microwaves and heat is always transferred from the food to the dish. The dishes are therefore hot.
- DO NOT** touch heating elements or interior oven walls.
Reason: These walls may be hot enough to burn even after cooking has finished, even though they do not appear to be so. Do not allow inflammable materials to come into contact with any interior area of the oven. Let the oven cool down first.
- To reduce the risk of fire in the oven cavity:
 - Do not store flammable materials in the oven
 - Remove wire twist ties from paper or plastic bags
 - Do not use your microwave oven to dry newspapers
 - If smoke is observed, keep the oven door closed and switch off or disconnect the oven from the power supply

Safety Precautions (continued)

8. Take particular care when heating liquids and baby foods.
 - ALWAYS allow a standing time of at least 20 seconds after the oven has been switched off so that the temperature can equalize.
 - Stir during heating, if necessary, and ALWAYS stir after heating.
 - Take care when handling the container after heating. You may burn yourself if the container is too hot.
 - Take particular care when heating liquids and baby foods.
 - A risk of delayed eruptive boiling exists.
 - To prevent delayed boiling and possible scalding, you should put a plastic spoon or glass stick into the beverages and stir before, during and after heating.

Reason: During the heating of liquids the boiling point can be delayed; this means that eruptive boiling can start after the container is removed from the oven. You may scald yourself.
 - In the event of scalding, follow these FIRST AID instructions:
 - * Immerse the scalded area in cold water for at least 10 minutes.
 - * Cover with a clean, dry dressing.
 - * Do not apply any creams, oils or lotions.
 - **NEVER** fill the container to the top and choose a container that is wider at the top than at the bottom to prevent the liquid from boiling over. Bottles with narrow necks may also explode if overheated.
 - **ALWAYS** check the temperature of baby food or milk before giving it to the baby.
 - **NEVER** heat a baby's bottle with the teat on, as the bottle may explode if overheated.
9. Be careful not to damage the power cable.
 - Do not immerse the power cable or plug in water and keep the power cable away from heated surfaces.
 - Do not operate this appliance if it has a damaged power cable or plug.
10. Stand at arm's length from the oven when opening the door.

Reason: The hot air or steam released may cause scalding.
11. Keep the inside of the oven clean.

Reason: Food particles or spattered oils stuck to oven walls or floor can cause paint damage and reduce the efficiency of the oven.
12. You may notice a "Clicking" sound during operation (especially when the oven is in defrosting).

Reason: This sound is normal when the electrical power output is changing.
13. When the microwave oven is operating without any load, the power will be cut off automatically for safety. You can operate normally after letting it stand for over 30 minutes.

IMPORTANT SAFETY INSTRUCTIONS

During cooking, you should look into the oven from time to time when food is being heated or cooked in disposable containers of plastic, paper or other combustible materials.

IMPORTANT

Young children should **NEVER** be allowed to use or play with the microwave oven. Nor should they be left unattended near the microwave oven when it is in use. Items of interest to children should not be stored or hidden just above the oven.

Installing Your Microwave oven

GB

Place the oven on a flat, level surface that strong enough to safely bear the weight of the oven.

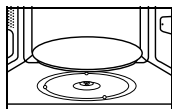
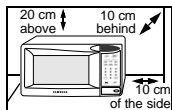

1. When you install your oven, Make sure there is adequate ventilation for your oven by leaving at least 10 cm (4 inches) of space behind, on the sides of the oven and 20 cm (8 inches) of above.
2. Remove all packing materials inside the oven. Install the roller ring and turntable. Check that the turntable rotates freely.
3. This microwave oven has to be positioned so that plug is accessible.

- ✎ **Never** block the air vents as the oven may overheat and automatically switch itself off. It will remain inoperable until it has cooled sufficiently.
- ✎ For your personal safety, plug the cable into a 3-pin, 240 Volt, 50Hz, AC earthed socket. If the power cable of this appliance is damaged, it must be replaced by a special cable. Contact your local dealer to have it replaced.
- ✎ **Do not** install the microwave oven in hot or damp surroundings like next to a traditional oven or radiator. The power supply specifications of the oven must be respected and any extension cable used must be of the same standard as the power cable supplied with the oven. Wipe the interior and the door seal with a damp cloth before using your microwave oven for the first time.

Setting the Time (M1734NCE/M1735NCE)

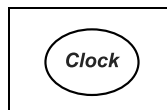

1. Press the **Clock** button.
The display will show : **0**

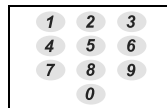

2. Use the **Number** buttons to enter the current time. You must press at least three numbers to set the clock. If the current time is 5:00 enter, **5,0,0**.
The display will show : **500**

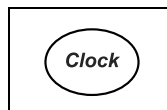

3. Press **Clock** button again. A colon will appear, indicating that the time set.
The display will show : **5:00**

- ✎ If there is a power interruption, you will need to reset the clock.
- ✎ You can check the current time while cooking is in progress by pressing the **Clock** button.

What to Do if You are in Doubt or Have a Problem

If you have any of the problems listed below try the solutions given.

- ◆ This is normal.
 - Condensation inside the oven
 - Air flow around the door and outer casing
 - Light reflection around the door and outer casing
 - Steam escaping from around the door or vents
- ◆ The oven does not start when you press the **One Minute+** button.(M1734NCE/M1735NCE)
 - Is the door completely closed?
- ◆ The oven does not start when you turn the **TIMER** knob.(M1713NCE)
 - Is the door completely closed?
- ◆ The food is not cooked at all
 - Have you set the timer correctly and/or pressed the **One Minute+** button?(M1734NCE/M1735NCE)
 - Have you set the timer correctly? (M1713NCE)
 - Is the door closed?
 - Have you overloaded the electric circuit and caused a fuse to blow or a breaker to be triggered?
- ◆ The food is either overcooked or undercooked
 - Was the appropriate cooking length set for the type of food?
 - Was an appropriate power level chosen?
- ◆ Sparking and cracking occur inside the oven (arcing)
 - Have you used a dish with metal trimmings?
 - Have you left a fork or other metal utensil inside the oven?
 - Is aluminium foil too close to the inside walls?
- ◆ The oven causes interference with radios or televisions
 - Slight interference may be observed on televisions or radios when the oven is operating. This is normal.To solve this problem, install the oven away from televisions, radios and aerials.
 - If interference is detected by the oven's microprocessor, the display may be reset. To solve this problem, disconnect the power plug and reconnect it. Reset the time. (M1734NCE/M1735NCE)

☒ If the above guidelines do not enable you to solve the problem, contact your local dealer or SAMSUNG after-sales service.

Cooking / Reheating

The following procedure explains how to cook or reheat food. **ALWAYS** check your cooking settings before leaving the oven unattended.

First, place the food in the centre of the turntable and close the door.

Model: M1734NCE / M1735NCE



1. Press the **Power Level** button.
Result : The **PL:Hi** (High cooking power) indications are displayed:
Select the appropriate power level by pressing the **Power Level** button again until the corresponding power level is displayed. Refer to the power level table on the next page.

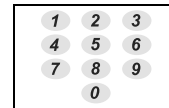

2. Use the **Number** buttons to set a cooking time. You can set a time from one second to 99 minutes, 99 seconds. To set a time over one minute, enter the seconds too. For example, to set 20 minutes, enter **2, 0, 0, 0**.

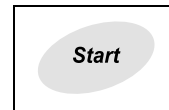

3. Press the **Start** button.
Result : The oven light comes on and the turntable starts rotating.
Cooking starts and when it has finished the oven beeps four times.



Never switch the microwave oven on when it is empty.



If you wish to heat a dish for a short period of time at high power (PL:Hi), simply press the **One Minute+** button once for each 1 minute of cooking time. The oven starts immediately.

Model: M1713NCE

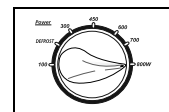

1. Set the power level to maximum by turning **COOKING POWER CONTROL** knob. (**MAXIMUM POWER: 800 W**)

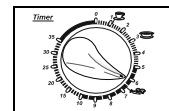

2. Set the time by turning **TIMER** knob.
Result : The oven light comes on and the turntable starts rotating.



Never switch the microwave oven on when it is empty.



You can change the power level during cooking by turning the **COOKING POWER CONTROL** knob.

Power Levels

GB

Model: M1734NCE / M1735NCE

The power level lets you control the heating intensity from Warm(10%) to High(100%) with the Power Level button.

Power Level	Output	Power Level	Output
PL:Hi = High	800 W	PL:50 = Medium	400 W
PL:90 =Sauté	720 W	PL:40 = Medium Low	320 W
PL:80 = Reheat	640 W	PL:30 = Defrost	240 W
PL:70 = Medium High	560 W	PL:20 = Low	160 W
PL:60 = Simmer	480 W	PL:10 = Warm	80 W

Model: M1713NCE

You can choose among the power level below.

Power Level	Output	Power Level	Output
HIGH	800 W	MEDIUM LOW	300 W
REHEAT	700 W	DEFROST	180 W
MEDIUM HIGH	600 W	LOW	100 W
MEDIUM	450 W		

Using the Pause/Cancel Button (M1734NCE/M1735NCE)

The Pause/Cancel button allows you to clear instructions you have entered. It also allows you to pause the oven's cooking cycle, so that you can check the food.

- To pause the oven during cooking: press **Pause/Cancel** once. To restart, press **Start**.
- To stop cooking, erase instructions, and return the oven display to the time of day: press **Pause/Cancel** twice.
- To correct a mistake you have just entered: press **Pause/Cancel** once, then re-enter the instructions.

Stopping the Cooking (M1713NCE)

You can stop cooking at any time to check the food.

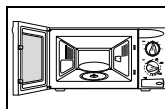

1. To stop temporarily;
Open the door.
Result : Cooking stops. To resume cooking, close the door.

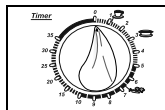

2. To stop Completely;
Turn the **TIMER** knob to "0".

Using the One Minute+ Button (M1734NCE/M1735NCE)

This button offers a convenient way to heat food in one-minute increments at the high power level.

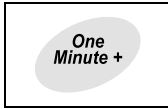

Press the **One Minute +** button once for each minute you wish to cook the food.

For example, press it twice for two minutes. The time will display, and the oven starts automatically.

- ☒ Add minutes to a program in progress by pressing the **One Minute +** button for each minute you want to add.
- ☒ You can only adjust the time during cooking when the time cook mode is selected.

Adjusting the Cooking Time (M1713NCE)

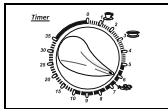

Adjust the remaining cooking time by rotating the **TIMER** knob.

Using the Instant Cooking Feature

Model: M1734NCE / M1735NCE

With the **Instant Cooking** feature, the cooking time is set automatically and you do not have to press the **Start** button. You can adjust the number of servings by pressing the appropriate **Instant Cooking** button the required number of times.

First, place the food in the centre of the turntable and close the door.

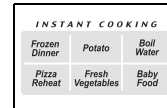

Press the **Instant Cooking** button which you want the required number of times.

Result: Cooking starts after about two seconds. When it has finished:

- 1) The oven beeps four times.
- 2) The end reminder signal will beep 3 times (once every minute).
- 3) The current time is displayed again.

Example: Press the **Boil Water** button twice times to reheat one cup of water. Refer to the table on the next page.

- ☒ Use only recipients that are microwave-safe.

Model: M1713NCE

- *First, place the food in the center of the turntable and close the door.*

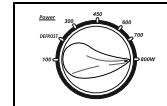

1. Turn the **COOKING POWER CONTROL** knob to Max Power.

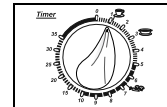

2. Turn the **TIMER** knob to select Instant Reheat. (drinks or soup/sauce, fresh vegetables).

- ☒ Use only recipients that are microwave-safe.

Instant Cooking Settings

GB



Model: M1734NCE / M1735NCE

The following table presents the various Instant cooking Programmes, quantities, standing times and appropriate recommendations.

Food	Serving Size	Recommendations
Frozen dinner	250 g-300 g 300 g-350 g	Remove package from outer wrapping and follow package instructions for covering and standing. After cooking, let stand 1-3 min.
Potato	1 EA, 2 EA 3 EA, 4 EA	Prick each potato several times with fork. Place on turntable in spoke-like fashion. Remove from oven, wrap in foil and let stand 3-5min. (Beep and stop at the half time. All potato should be turned over at half the cooking time.)
Boil water	½ cup 1 cup 2 cups	Measure liquid; pour into microwave-safe container that is 2 times larger than amount of liquid. Example: For 1 cup liquid use a 2 cup or larger dish. Stir well before and after heating to prevent boil over.
Pizza Reheat	1 Slice 2 Slices 3 Slices	Put the pizza on a microwave-safe plate with wide end of slice towards the outside edge of the plate. Do not let slices overlap. Do not cover. Before serving, let stand 1-2 min.
Fresh Vegetables	1 serving 2 servings 3 servings 4 servings	Place the vegetables into a casserole bowl and add a small amount of water (2-4Tbsp). Cover during cooking and stir before standing.
Baby food	70 g 100 g 150 g	Remove lid from baby food and place in the center of oven. Check temperature and stir well before serving.

Model: M1713NCE

Here are a few tips and recommendations to be followed when cooking or reheating food with Instant Cooking Feature.

Symbols	Food	Serving Size	Cooking Time	Standing Time
	Drinks	150 ml	1 min 10 sec	1 - 2 min.
	Soup/Sauce (chilled)	200-250 ml	3 min	2 - 3 min.
	Fresh vegetables	300-350 g	6 min 40 sec	3 min.

Manual Defrost Food

Model: M1734NCE / M1735NCE

The defrost setting is designed for speedy thawing of frozen food and is one of the great advantages of the microwave oven. (Power level of 30% is automatically set for defrosting)



1. Press the **Defrost** button.
The display shows: **PL:30**

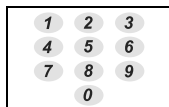

2. Press the button(0-9) sequentially to enter the desired defrosting time.

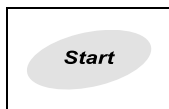

3. Press the **Start** button to begin defrosting.

☒ See the defrosting guide of the opposite side.

Model: M1713NCE

The Defrost feature enables you to defrost meat, poultry, fish.

First, place the frozen food in the centre of the turntable and close the door.

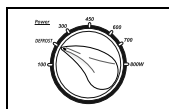

1. Turn the **COOKING POWER CONTROL** knob to **DEFROST (180W)**.

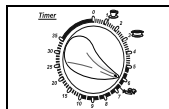

2. Turn the **TIMER** knob to select the appropriate time.
Result: Defrosting begins.

☒ Use only recipients that are microwave-safe.

Manual Defrosting Guide

- Unwrap food. Place food on microwave-safe rack, plate or shallow dish.
- After first half of defrosting time: remove any remaining wrap, break food apart or separate pieces if possible, remove any thawed food, if possible, shield tips, thin meat or warm areas of food with foil.
- When defrosted, food should be cool, but softened in all areas. If still slightly icy, return to microwave oven very briefly, or let stand a few minutes.
- Poultry and fish may be placed under running cool water until defrosted.

GB

	Food	Microwave Time at Defrost Level	Standing Time	Directions
	Chuck Roast up to 2 kg	7-9 min / 0.5 kg	5-10 min	Place on plate or rack. Microwave until a wooden pick can be easily inserted in center. Turn over twice.
Beef	Steaks up to 2 kg	6-9 min / 0.5 kg	5-10 min	Place on plate or rack. Microwave until pliable, then separate steaks and rearrange. Turn over twice.
	Ground Beef up to 1.5 kg	8-10 min / 0.5 kg	5-10 min	Place on plate or rack. Microwave until pliable, then break apart and remove defrosted portions at halftime. Turn over twice.
	Spareribs up to 1.5 kg	6-8 min / 0.5 kg	5-10 min	Place on plate or rack. Microwave until pliable, then separate and rearrange. Turn over twice.
Pork	Chops up to 1.5 kg	6-8 min / 0.5 kg	5-10 min	Place on plate or rack. Microwave until pliable, then separate and rearrange. Turn over twice.
	Whole Chicken up to 2 kg	7-9 min / 0.5 kg	5-10 min	Place on plate or rack. Microwave until pliable, then break apart and rearrange portions at halftime. Rinse cavity with cool water. Remove giblets.
Poultry	Pieces up to 1 kg	9-11 min / 0.5 kg	5-10 min	Place on plate or rack. Microwave until pliable, then break apart and rearrange portions at half time.

Defrost Guide (Continued)

GB

	Food	Microwave Time at Defrost Level	Standing Time	Directions
	Steaks up to 1-2 kg	6-9 min / 0.5 kg	5-10 min	Place on plate or rack. Microwave until a wooden pick can be easily inserted in center, break apart and rearrange at half time.
Sea- food	Fillets up to 1-2 kg	4-7 min / 0.5 kg	5-10 min	Place on plate or rack. Microwave until a wooden pick can be easily inserted in center, break apart and rearrange at half time.
	Shrimp up to 1.5 kg	4-7 min / 0.5 kg	5-10 min	Place on plate or rack. Microwave until pliable, then separate and rearrange at half time

Multistage Cooking (M1734NCE/M1735NCE)

Your microwave oven can be programmed to cook food up to two stages.

Example: You wish to defrost food and cook it without having to reset the oven after each stage. You can thus defrost and cook a 500g beef in two stages:

- **Defrosting**
- **Cook**

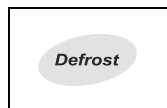

1. Press the **Defrost** button.
The defrost power level is set automatically.
The display shows: **PL:30**

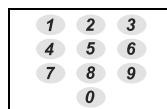

2. Use the **Number** buttons to set a defrosting time. You can set a time from one second to 99 minutes, 99 seconds. To set a time over one minute, enter the seconds too. For example, to set 10 minutes, enter **1, 0, 0, 0**.

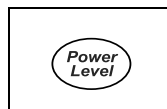

3. Press the **Power Level** button.
Result: The **PL:Hi** (High cooking power) indications are displayed:
Select the appropriate power level by pressing the **Power Level** button again until the corresponding power level is displayed.

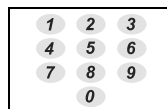

4. Use the **Number** buttons to set a cooking time. You can set a time from one second to 99 minutes, 99 seconds. To set a time over one minute, enter the seconds too. For example, to set 5 minutes, enter **5, 0, 0**.

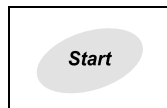

5. Press the **Start** button.
Result: When it has finished:
 - 1) The oven beeps four times.
 - 2) The end reminder signal will beep 3 times (once every minute).
 - 3) The current time is displayed again.

Cookware Guide

To cook food in the microwave oven, the microwaves must be able to penetrate the food, without being reflected or absorbed by the dish used.

Care must therefore be taken when choosing the cookware. If the cookware is marked microwave-safe, you do not need to worry.

The following table lists various types of cookware and indicates whether and how they should be used in a microwave oven.

Cookware	Microwave-Safe	Comments
Aluminium foil	✓ X	Can be used in small quantities to protect areas against overcooking. Arcing can occur if the foil is too close to the oven wall or if too much foil is used.
Browning plate	✓	Do not preheat for more than eight minutes.
China and earthenware	✓	Porcelain, pottery, glazed earthenware and bone china are usually suitable, unless decorated with a metal trim.
Disposable polyester cardboard dishes	✓	Some frozen foods are packaged in these dishes.
Fast-food packaging		
• Polystyrene cups containers	✓	Can be used to warm food. Overheating may cause the polystyrene to melt.
• Paper bags or newspaper	X	May catch fire.
• Recycled paper or metal trims	X	May cause arcing.
Glassware		
• Oven-to-table ware	✓	Can be used, unless decorated with a metal trim.
• Fine glassware	✓	Can be used to warm foods or liquids. Delicate glass may break or crack if heated suddenly.
• Glass jars	✓	Must remove the lid. Suitable for warming only.

Metal		
• Dishes	X	May cause arcing or fire.
• Freezer bag twist ties	X	
Paper		
• Plates, cups, napkins and Kitchen paper	✓	For short cooking times and warming. Also to absorb excess moisture.
• Recycled paper	X	May cause arcing.
Plastic		
• Containers	✓	Particularly if heat-resistant thermoplastic. Some other plastics may warp or discolour at high temperatures. Do not use Melamine plastic.
• Cling film	✓	Can be used to retain moisture. Should not touch the food. Take care when removing the film as hot steam will escape.
• Freezer bags	✓ X	Only if boilable or oven-proof. Should not be airtight. Prick with a fork, if necessary.
Wax or grease-proof paper	✓	Can be used to retain moisture and prevent spattering.

✓ : Recommended

✓ X : Use Caution

X : Unsafe

Cleaning Your Microwave Oven

GB

The following parts of your microwave oven should be cleaned regularly to prevent grease and food particles from building up:

- **Inside and outside surfaces**
- **Door and door seals**
- **Turntable and Roller rings**

✎ **ALWAYS** ensure that the door seals are clean and the door closes properly.

1. Clean the outside surfaces with a soft cloth and warm, soapy water. Rinse and dry.
2. Remove any splashes or stains on the inside surfaces or on the roller ring with a soapy cloth. Rinse and dry.
3. To loosen hardened food particles and remove smells, place a cup of diluted lemon juice on the turntable and heat for ten minutes at maximum power.
4. Wash the dishwasher-safe plate whenever necessary.

- ⊠ **DO NOT** spill water in the vents. **NEVER** use any abrasive products or chemical solvents. Take particular care when cleaning the door seals to ensure that no particles:
- Accumulate
 - Prevent the door from closing correctly

Technical Specifications

SAMSUNG strives to improve its products at all times. Both the design specifications and these user instructions are thus subject to change without notice.

Model	M1734NCE / M1735NCE / M1713NCE
Power source	240V ~ 50 Hz
Power consumption Microwave	1150 W
Output power	100 W / 800 W (IEC-705)
Operating frequency	2450 MHz
Magnetron	OM75S(31)
Cooling method	Cooling fan motor
Dimensions (W x H x D) Outside Oven cavity	489 x 275 x 361 mm 306 x 211 x 320 mm
Volume	20 liter
Weight Net	12.5 kg approx

