



**5/9 Console 32-Port Matrix KVM Switch
KM0532 / KM0932**

**Matrix Expansion KVM Switch
KM0032**

User Manual



FCC Information

This is an FCC Class A product. In a domestic environment this product may cause radio interference in which case the user may be required to take adequate measures.

This equipment has been tested and found to comply with the limits for a Class A digital device, pursuant to Part 15 of the FCC Rules. These limits are designed to provide reasonable protection against harmful interference when the equipment is operated in a commercial environment. This equipment generates, uses and can radiate radio frequency energy and, if not installed and used in accordance with the instruction manual, may cause harmful interference to radio communications. Operation of this equipment in a residential area is likely to cause harmful interference in which case the user will be required to correct the interference at his own expense.

RoHS

This product is RoHS compliant.

SJ/T 11364-2006

The following contains information that relates to China.

部件名称	有毒有害物质或元素					
	铅	汞	镉	六价铬	多溴联苯	多溴二苯醚
电器部件	●	○	○	○	○	○
机构部件	○	○	○	○	○	○

- : 表示该有毒有害物质在该部件所有均质材料中的含量均在SJ/T 11363-2006规定的限量要求之下。
- : 表示符合欧盟的豁免条款, 但该有毒有害物质至少在该部件的某一均质材料中的含量超出SJ/T 11363-2006的限量要求。
- ×: 表示该有毒有害物质至少在该部件的某一均质材料中的含量超出SJ/T 11363-2006的限量要求。



User Information

Online Registration

Be sure to register your product at our online support center:

International	http://support.aten.com
North America	http://www.aten-usa.com/product_registration

Telephone Support

For telephone support, call this number:

International		886-2-8692-6959
North America	ATEN TECH	1-888-999-ATEN
	ATEN NJ	1-732-356-1703
UK		44-8-4481-58923

User Notice

All information, documentation, and specifications contained in this manual are subject to change without prior notification by the manufacturer. The manufacturer makes no representations or warranties, either expressed or implied, with respect to the contents hereof and specifically disclaims any warranties as to merchantability or fitness for any particular purpose. Any of the manufacturer's software described in this manual is sold or licensed *as is*. Should the programs prove defective following their purchase, the buyer (and not the manufacturer, its distributor, or its dealer), assumes the entire cost of all necessary servicing, repair and any incidental or consequential damages resulting from any defect in the software.

The manufacturer of this system is not responsible for any radio and/or TV interference caused by unauthorized modifications to this device. It is the responsibility of the user to correct such interference.

The manufacturer is not responsible for any damage incurred in the operation of this system if the correct operational voltage setting was not selected prior to operation. PLEASE VERIFY THAT THE VOLTAGE SETTING IS CORRECT BEFORE USE.

Package Contents

The KM0032 / KM0532 / KM0932 package consists of:

- 1 KM0032, KM0532, or KM0932
- 2 Power Cords
- 1 Daisy Chain Cable (KM0032 only)
- 1 Grounding Wire
- 1 Rack Mount Kit
- 1 Foot Pad Set (4 pcs.)
- 1 User Manual*
- 1 Quick Start Guide

Check to make sure that all of the components are present and in good order. If anything is missing, or was damaged in shipping, contact your dealer.

Read this manual thoroughly and follow the installation and operation procedures carefully to prevent any damage to the switch or to any other devices on the KM0032 / KM0532 / KM0932 installation.

* Features may have been added to the switch since this manual was printed. Please visit our website to download the most up to date version of the manual.

Copyright © 2009 ATEN® International Co., Ltd.
Manual Part No. PAPE-0308-AX1G
F/W Version: 1.2.111
Manual Date: 2009-10-02

Altusen and the Altusen logo are registered trademarks of ATEN International Co., Ltd. All rights reserved.
All other brand names and trademarks are the registered property of their respective owners.

Contents

FCC Information	ii
SJ/T 11364-2006.	ii
User Information	iii
Online Registration	iii
Telephone Support	iii
User Notice	iii
Package Contents.	iv
About This Manual	xi
Overview	xi
Conventions	xii
Product Information.	xii

Chapter 1.

Introduction

Overview	1
Features	2
Requirements	4
Consoles	4
Computers.	4
Cables	5
KVM Adapter Cables	5
Connecting Cables	5
Operating Systems	5
Components	6
KM0532 / KM0932 Front View	6
KM0032 Front View.	8
KM0532 / KM0932 Rear View.	9
KM0032 Rear View	10

Chapter 2.

Hardware Setup

Overview	11
Before you Begin.	12
Stacking and Rack Mounting	12
Stacking.	12
Rack Mounting	13
Rack Mounting - Front	13
Rack Mounting - Rear	15
Grounding	17
Single Level Installation	18
Multilevel Installations	20
Overview	20
Cascading	21

Cascading KM0532 / KM0932 Switches	22
Cascading Other KVM Switches	24
Daisy Chaining	25
Network Administration	26
Topology Considerations	26

Chapter 3.

Super Administrator Setup

Overview	27
First Time Setup	27
Network Configuration	29
Changing the Super Administrator Login	30
Moving On	31

Chapter 4.

Logging In

Overview	33
Console Login	33
Browser Login	34

Chapter 5.

The User Interface

Overview	35
The Console UI	35
Console UI Page Components	36
Console UI Keyboard Navigation	37
The Browser UI	38
Browser UI Page Components	39

Chapter 6.

Device Management

Overview	41
Device	41
Console UI	41
Browser UI	42
Network	44
Console UI	44
Browser UI	44
Service Ports	45
IP Address	45
DNS Server	45
ANMS	46
Console UI	46
Browser UI	46

IP Installer	47
SMTP Settings	47
Association	48
Power Management	48
Summary	51
Date/Time	52
Console UI	52
Date	52
Time	52
Time Zone	52
Browser UI	53
Current System Time	53
New System Time	54
Time Zone	54
System	55
Console UI	55
Browser UI	55

Chapter 7.

User Management

Overview	57
Accounts	57
Adding Users	58
Modifying User Accounts	61
Deleting User Accounts	61
Groups	62
Creating Groups	62
Modifying Groups	64
Deleting Groups	64
Users and Groups	65
Assigning Users to a Group From the User Menu	65
Removing Users From a Group From the User Menu	66
Assigning Users to a Group From the Group Menu	68
Removing Users From a Group From the Group Menu	70
Device Assignment	72
Assigning Device Permissions From the User Menu	72
Assigning Device Permissions From the Group Menu	74

Chapter 8.

Port Access

Overview	75
Console UI	75
Browser UI	75
Page Layout	76
The Port Selection Sidebar	76

The Port Selection Tree	76
Show	77
Connections	78
Device Level	78
Console UI	78
Browser UI	78
Port Level	79
Console UI	79
Browser UI	80
Associated Link	80
Favorites	81
Console UI	81
Browser UI	81
Adding a Favorite	82
Removing a Favorite	82
History	82
Preferences	83
Console UI	83
Browser UI	83
Changing the Preference Settings	84
Restore Defaults	85
Sessions	86
Kill Session	86
Scan	87
Broadcast	87
Access	88
Console UI	88
Browser UI	88
Properties	90
Configuring Port Properties	90
Console UI	90
Browser UI	90
Restore Defaults	91
PON	92

Chapter 9.

Log

Overview	93
Console UI	94
Log Filtering	94
Browser UI	95
Log Filtering	95
Export	95

Chapter 10.**Maintenance**

Overview	97
Backup / Restore	97
Backup	98
Restore	99
Firmware Upgrade	100
Firmware Upgrade Recovery	102
Adapter Cable Firmware Upgrade Recovery	102

Chapter 11.**Console Port Operation**

Overview	103
The Port Toolbar	104
Recalling the Port Access Page	104
Closing the Toolbar	104
The Toolbar Icons	105
Toolbar Hotkey Port Switching	106
Auto Scanning	106
Skip Mode Switching	107
Port Number Switching	107
Keyboard Hotkey Port Switching	108
Port ID Numbering	108
Hotkey Summary Table	109

Chapter 12.**RS-232 Port Operation**

Overview	111
Preparation	111
Connecting	112
Restrictions	113
Command Summary	114
SP	115
Example 1 – Single Stage Installation:	115
Example 2 – Two Level Cascaded Installation:	115
Example 3 – Daisy Chained Installation:	116
TK	116
TS	116
LI	117
LU	117

Appendix

Safety Instructions	119
General	119
Rack Mounting	121

Technical Support	122
International	122
North America	122
Trusted Certificates	123
Overview	123
IP Address Determination	124
The Local Console	124
IP Installer	124
Browser	125
Troubleshooting	126
Overview	126
Sun Systems	128
Supported KVM Switches	129
Additional Connection Diagrams	130
Console Modules	130
KVM Adapter Cables	131
KM0532 / KM0932 Specifications	132
KM0032 Specifications	133
Factory Default Settings	134
Restoring Factory Default Settings	135
KA7140 Pin Assignments	136
About SPHD Connectors	136
Limited Warranty	137

About This Manual

This manual will help you get the most from your KM0032 / KM0532 / KM0932 system. It covers all aspects of installation, configuration and operation. The information provided in the manual is summarized below.

Overview

Chapter 1, Introduction, introduces you to the KM0032 / KM0532 / KM0932 System. Its purpose, features and benefits are presented, and its front and back panel components are described.

Chapter 2, Hardware Setup, provides step-by-step instructions for setting up your installation, and explains some basic operation procedures.

Chapter 3, Super Administrator Setup, explains the procedures that the super administrator employs to set up the KM0032 / KM0532 / KM0932 network environment, and change the default password.

Chapter 4, Logging In, describes how to log in to the KM0032 / KM0532 / KM0932 from a local console and an internet browser.

Chapter 5, The User Interface, describes the layout and explains the components of the KM0032 / KM0532 / KM0932 user interface.

Chapter 6, Device Management, shows super administrators how to configure and control overall KM0032 / KM0532 / KM0932 operations.

Chapter 7, User Management, shows super administrators and administrators how to create, modify, and delete users and groups, and assign attributes to them.

Chapter 8, Port Access, describes the features and functions found under the Port Access tab and explains how to configure the options it provides.

Chapter 9, Log, explains how to use the log file utility to view the events that take place on the Matrix KVM Switch installation.

Chapter 10, Maintenance, shows how to backup and restore system configuration settings, and how to perform firmware upgrades.

Chapter 11, Console Port Operation, provides detailed information on accessing and operating the devices connected to the KM0032 / KM0532 / KM0932's ports.

Chapter 12, RS-232 Port Operation, explains how to access and operate the devices connected to the KM0032 / KM0532 / KM0932 via a serial terminal connection.

An Appendix, provides technical and troubleshooting information.

Conventions

This manual uses the following conventions:

- Monospaced Indicates text that you should key in.
- [] Indicates keys you should press. For example, [Enter] means to press the **Enter** key. If keys need to be chorded, they appear together in the same bracket with a plus sign between them: [Ctrl+Alt].
- 1. Numbered lists represent procedures with sequential steps.
- ◆ Bullet lists provide information, but do not involve sequential steps.
- Indicates selecting the option (on a menu or dialog box, for example), that comes next. For example, Start → Run means to open the *Start* menu, and then select *Run*.
-  Indicates critical information.

Product Information

For information about all ALTUSEN products and how they can help you connect without limits, visit ALTUSEN on the Web or contact an ALTUSEN Authorized Reseller. Visit ALTUSEN on the Web for a list of locations and telephone numbers:

International		http://www.aten.com
North America	ATEN TECH	http://www.aten-usa.com
	ATEN NJ	http://www.aten.com

Chapter 1

Introduction

Overview

The KM0032 / KM0532 / KM0932 Matrix KVM Switch gives IT administrators in large corporations advanced access and control of multiple servers. Operators working at up to 5 (KM0532) or 9 (KM0932) keyboard, mouse, and monitor (KVM) consoles can simultaneously and independently take direct control of up to 32 computers. With a combination of daisy chaining and cascading, up to 9 consoles can access and control more than 8,000 computers from the first level KM0932 Matrix KVM Switch.

The Matrix KVM Switch product lineup consists of three basic models, as shown in the table, below:

Model	Consoles	Power
KM0032	0*	Dual
KM0532	5	Dual
KM0932	9	Dual

* KM0032 switches operate as slaves chained to a KM0532 or KM0932. As such, they do not use a console of their own. Devices connected to them are accessed through a console belonging to the master KM0532 or KM0932.

Setup is fast and easy; plugging cables into their appropriate ports is all that is entailed. The Matrix KVM switches feature a Console Module and KVM Adapter Cable design with automatic console conversion that allows any combination PS/2 and USB consoles to control any combination of PS/2, USB, or Sun computers.

The RJ-45 port connectors, combined with Auto Signal Compensation (ASC), provide full, non-blocked access to servers and deliver secure real-time, high bandwidth video up to 1,000 feet away, with automatic compensation for any video loss induced by cabling, thereby eliminating the need for KVM extenders.

Operating over end-to-end UTP cabling allows the installation to take advantage of the internal CAT 5e and CAT6 wiring built in to most modern commercial buildings.

Server access and control is easily accomplished by means of a convenient, intuitive, graphical user interface. In addition, once initial network setup has been accomplished at the local console level, system administration can conveniently be managed remotely over the internet from any web browser.

Features

- ◆ 9 (KM0932) or 5 (KM0532) consoles independently and simultaneously control up to 32 directly connected computers
- ◆ Standardized graphical user interface – consistent across all Altusen products – saves on training time and costs – increases user efficiency
- ◆ Embedded web interface for easy system configuration and management
- ◆ Redundant power supply for Matrix KVM system
- ◆ Virtual Media Support – allows sharing of directly-connected USB storage devices to all servers connected with virtual media enabled adapter cables
- ◆ Power Association enables switch's KVM ports to be power controlled via associated Altusen PON products
- ◆ Dual Root functionality allows you to expand your top-level KM0932 deployment to 18 consoles.
- ◆ RS-232 port permits user logged in over the port to perform Console and KVM port access and control for all consoles and ports from a single interface point
- ◆ Saves valuable time - backup and restore settings when changing master stations – backup user and group accounts, station names, port access rights, and user profile settings. Clear port note, PC name, station name, access right, group, user name and personal profiles.
- ◆ Supports up to 1024 user and 255 group accounts
- ◆ Audio support for multimedia-capable devices combined with audio enabled adapter cables
- ◆ Three level password security: *Super Administrator, Administrator, User*
- ◆ Port level access control – users can only access the ports they have been authorized for – whether in a single-station installation or a daisy chained/cascaded installation
- ◆ Up to 7 slave switches can be daisy chained from a master switch
- ◆ Switches can be cascaded to three levels to access and manage more than 8,000 computers

- ◆ Multiplatform support: PC, Mac, Sun, and serial devices
- ◆ End Session function gives Super Administrators and Administrators the ability to terminate user sessions
- ◆ Console conversion – any type of console can control any type of computer; mixed combinations (PS/2 & USB) supported on both the console and computer sides
- ◆ An additional user port is provided on the front panel for easy system maintenance
- ◆ Convenient computer selection via intuitive hotkey combinations or GUI
- ◆ The GUI port list automatically expands when stations are added – port names are automatically reconfigured when the station sequence changes
- ◆ User's display automatically adjusts to resolution differences on the remote servers
- ◆ Auto Scan feature for monitoring user-selected computers
- ◆ Superior video quality – 1280 x 1024 @ 60 Hz for up to 300m
- ◆ Auto Signal Compensation (ASC) assures optimum video resolution for distances up to 300m between computers and consoles – no DIP switch setting required
- ◆ Compact design – rack mounts in only 1U of rack space
- ◆ A master station can allocate the best available path for the user. If the current path is busy and there is another path available the user is automatically redirected to the available path.
- ◆ Users can access features on multiple computers simultaneously – a user can be working and listening to music on computer 1 while utilizing virtual media on computer 2 at the same time.
- ◆ A firmware upgrade can be performed simultaneously on all daisy chained and cascaded slave switches as well as connected adapter cables
- ◆ Versatile port operation modes for flexible server management:
 - ◆ Scan – provides automatic monitoring of user-selected computers
 - ◆ Exclusive – allows the first user to access a port to gain exclusive viewing rights and control over it for as long as he accesses it
 - ◆ Occupy – allows the first user to access a port to control that port while others can only view it
 - ◆ Share – allows multiple users to access and control a port at the same time on a cooperative basis

- ◆ Broadcast support enables executing the same command on multiple servers at the same time
- ◆ Multilingual user interface support
- ◆ Enhanced video quality via automatic skew compensation support for the KA7240 adapter cable, and the newer adapter cable series (KA7120, KA7170, KA7130 KA7176)
- ◆ Station Numbers (SN), Port Numbers (PN), serial devices, and power devices are all integrated for management and control in a single GUI
- ◆ Supports cascading KH1506 / KH1516 switches for low-cost expansion

Requirements

Consoles

The following hardware components are required for each KVM console:

- ◆ A VGA, SVGA, or multisync monitor capable of displaying the highest resolution provided by any computer on the installation
- ◆ Keyboard and mouse (PS/2 or USB)

Console modules are required to connect KVM consoles to the KM0532 / KM0932. They provide flexibility for your installation by allowing PS/2 and USB interfaces to be mixed and matched at the KVM console side. The console modules currently available are listed in the table below. Contact your dealer for details or refer to the documentation included with your console module.

Function	Model Number
PS/2-USB Combo Graphic Console Module with dual RJ-45 and RS232	KA7230
PS/2-USB Combo Graphic Console Module with dual RJ-45, RS232, virtual media and audio	KA7240

Computers

The following hardware components are required for each computer that connects to the switch:

- ◆ A VGA, SVGA, or multisync video graphics card with an HDB-15 port; or, for legacy Sun systems, a Sun 13W3 video port
- ◆ PS/2 mouse and keyboard ports (6-pin Mini-DIN), or at least one USB port; or, for legacy Sun systems, a Sun style keyboard port (8-pin Mini-DIN)

Cables

KVM Adapter Cables

KVM adapter cables connect multiplatform computers (PS/2, USB, Sun, Mac, and serial) and certain cascaded KVM switches to the KM0032 / KM0532 / KM0932. The KVM adapter cables currently available are listed in the table below. Contact your dealer for details.

Function	Model Number
For PS/2 computers	KA7120, KA9120
For Sun legacy computers	KA7130, KA9130
For serial devices	KA7140, KA9140
For USB computers (including Sun and Mac)	KA7170, KA9170
For USB computers – Virtual Media and Audio support	KA7176

Connecting Cables

Other cables that are used to connect up the KM0032 / KM0532 / KM0932 installation include the following:

Function	Type
Connecting Console Modules or KVM Adapter Cable to the switch	Cat 5e Ethernet cable
Daisy Chaining switches	LIN5-68H1-H11G (45 cm)

Operating Systems

Supported operating systems are shown in the table, below:

OS	Version	
Windows	2000 and higher	
Linux	RedHat	7.1 and higher
	Fedora	Core 2 and higher
	SuSE	9.0 and higher
	Mandriva (Mandrake)	9.0 and higher
UNIX	AIX	4.3 and higher
	FreeBSD	4.2 and higher
	Sun	Solaris 8 and higher
Novell	Netware	5.0 and higher
Mac	OS 9 and higher	

Components

KM0532 / KM0932 Front View

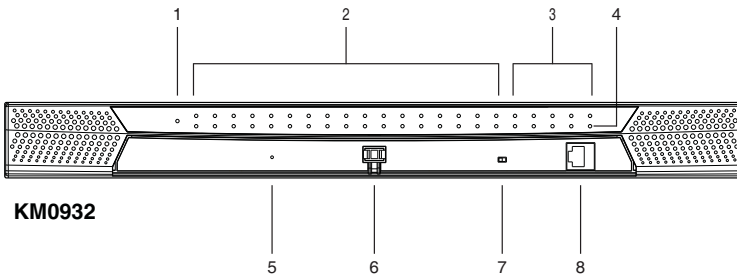
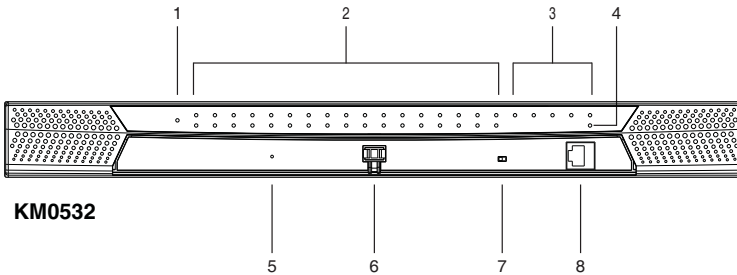

No.	Component	Description
1	Power LED	Lights (blue) to indicate that the unit is receiving power.
2	KVM Port LEDs	The KVM Port LEDs provide status information about their corresponding KVM Ports, They light as follows: <ul style="list-style-type: none"> ◆ GREEN: The computer connected to its corresponding port is On Line. ◆ GREEN & Flashing: Its corresponding port is connected to a cascaded KVM switch. ◆ RED: The computer attached to its corresponding port is Selected (it has the KVM focus). ◆ The LED does not light when there is no online device connected to its corresponding port.
3	Console (User) Port LEDs	Lights (green) to indicate that the console module connected to the corresponding user port is online.

No.	Component	Description
4	LAN LED	<ul style="list-style-type: none">◆ The LED lights ORANGE to indicate 10 Mbps data transmission speed.◆ The LED lights GREEN to indicate 100 Mbps data transmission speed.◆ The LED flashes when data is being transmitted
5	Reset Switch	<p>Pressing in this button performs a system reset. When the system is reset, the switch beeps, and then the KVM port LEDs flash in succession until the reset is completed. After the reset is completed you can login again.</p> <p>Note: This switch is recessed and must be pushed with a thin object.</p>
6	Cover Latch	
7	Firmware Upgrade Recovery Switch	<p>During normal operation and while performing a firmware upgrade, this switch should be in the NORMAL position. If a firmware upgrade operation does not complete successfully, this switch is used to perform a firmware upgrade recovery (see <i>Firmware Upgrade Recovery</i>, page 102, for details).</p>
8	Console (User) Port	<p>This console port is provided on the front panel for easy administrative access</p>

KM0032 Front View

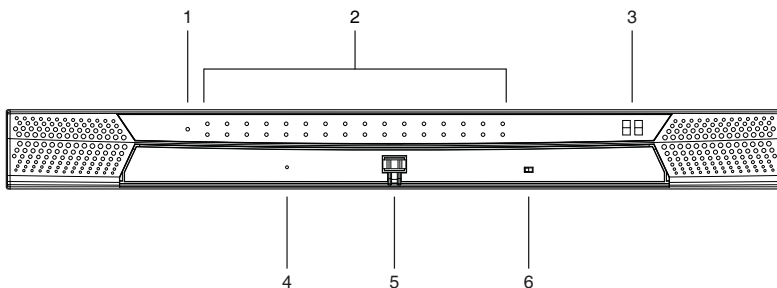

No.	Component	Description
1	Power LED	Lights (blue) to indicate that the unit is receiving power.
2	Port LEDs	<p>The Port LEDs provide status information about their corresponding KVM Ports, They light as follows:</p> <ul style="list-style-type: none"> ◆ GREEN: The computer connected to its corresponding port is On Line. ◆ GREEN & Flashing: Its corresponding port is connected to a cascaded KVM switch. ◆ RED: The computer attached to its corresponding port is Selected (it has the KVM focus). ◆ The LED does not light when there is no online device connected to its corresponding port.
3	Station ID LED	The KM0032's Station ID is displayed here. It indicates the KM0032's position in a daisy chained installation. The first station in the chain has a Station ID of 01; the second has a Station ID of 02, etc.
4	Reset Switch	<p>Pressing in this button performs a system reset. When the system is reset, the switch beeps, and then the KVM port LEDs flash in succession until the reset is completed. After the reset is completed you can login again.</p> <p>Note: This switch is recessed and must be pushed with a thin object.</p>
5	Cover Latch	
6	Firmware Upgrade Recovery Switch	During normal operation and while performing a firmware upgrade, this switch should be in the NORMAL position. If a firmware upgrade operation does not complete successfully, this switch is used to perform a firmware upgrade recovery (see <i>Firmware Upgrade Recovery</i> , page 102, for details).

KM0532 / KM0932 Rear View

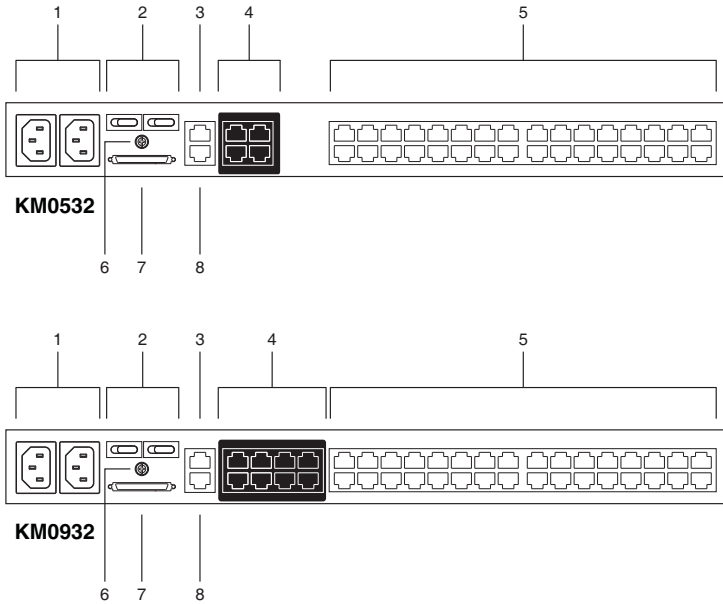

No.	Component	Description
1	Power Sockets	The power cords from the AC source plug in here. The socket on the left is Socket 1; the socket on the right is Socket 2.
2	Power Switches	These switches power the KM0532 / KM0932 on and off. The switch on the left is Switch 1 and governs Socket 1; the switch on the right is Switch 2 and governs Socket 2.
3	PON Port	This connector is provided for a Power over the Net™ (PON) unit to plug into. A PON device allows computers attached to the switch to be power-managed remotely over the net. Contact your dealer for more details.
4	Console Ports	The Cat 5e cables from the console modules plug in here.
5	KVM Ports	The Cat 5e cables that link the KM0532 / KM0932 to the KVM Adapter Cables (which connect to the computers – see page 18), plug in here.
6	Grounding Terminal	The wire used to ground the switch attaches here.
7	CHAIN OUT Port	The CHAIN OUT port is used to connect the daisy chain cable to the CHAIN IN port of a daisy chained KM0032 switch (see page 26).
8	LAN Port	The cable from the LAN, WAN, or Intranet plugs in here.

KM0032 Rear View

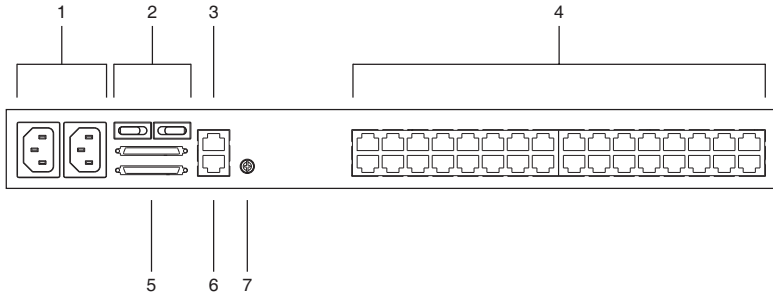

No.	Component	Description
1	Power Sockets	The power cords from the AC source plug in here. The socket on the left is Socket 1; the socket on the right is Socket 2.
2	Power Switches	These switches power the KM0032 on and off. The switch on the left is Switch 1 and governs Socket 1; the switch on the right is Switch 2 and governs Socket 2.
3	PON Port	This connector is provided for a Power over the Net™ (PON) unit to plug into. A PON device allows computers attached to the switch to be power-managed remotely over the net. Contact your dealer for more details.
4	KVM Ports	The Cat 5e cables that link the KM0032 to the KVM Adapter Cables (which connect to the computers – see page 18), plug in here.
5	Daisy Chain Ports	When daisy chaining KM0032 switches (see page 26), the daisy chain cables plug in here. The upper port is the <i>Chain In</i> port; the lower one is the <i>Chain Out</i> port.
6	Firmware Upgrade Port	The firmware upgrade cable that transfers the firmware upgrade data from the administrator's computer to the KM0032, plugs into this RJ-11 connector.
7	Grounding Terminal	The wire used to ground the KM0032 attaches here.

Chapter 2

Hardware Setup

Overview

For convenience and flexibility, the KM0532 / KM0932's design utilizes *console modules* that act as signal translation intermediaries between the KVM consoles and the KVM switch. This allows PS/2 and USB interface consoles to coexist on the same installation.

The design also uses *KVM adapter cables*, that serve as intermediaries between the KVM switch and the computers, and provides the basis for multiplatform support:

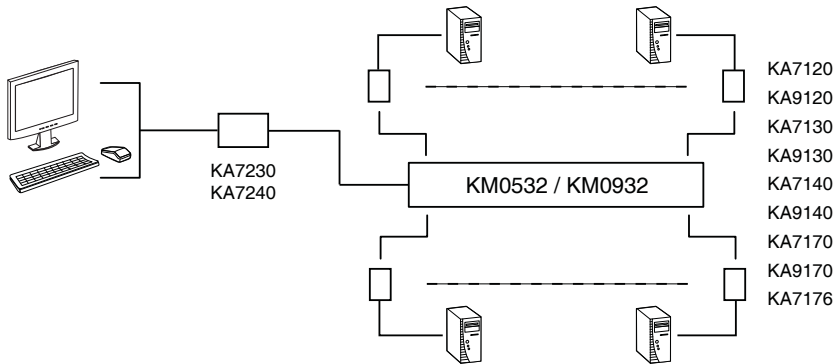

A separate console module is required for each KVM console; likewise, a separate KVM adapter cable is required for each computer. For a listing of compatible console modules, see *Consoles*, page 4. For a listing of compatible KVM adapter cables, see *Cables*, page 5.

As a cost-saving feature, KM0032 switches, can be daisy chained down from a KM0532 or KM0932. Since devices connected to them are accessed through one of the KM0532 or KM0932 consoles, they don't require a console of their own.

Before you Begin



1. Important safety information regarding the placement of this device is provided on page 119. Please review it before proceeding.
2. Make sure that power to all the devices you will be connecting up has been turned off. You must unplug the power cords of any computers that have the Keyboard Power On function.

Stacking and Rack Mounting

The KM0032 / KM0532 / KM0932 can be stacked on the desktop or rack mounted in a variety of ways. The following sections take you through the procedures for each method.

Stacking

The KM0032 / KM0532 / KM0932 can be placed on any appropriate level surface that can safely support its weight plus the weight of its attached cables. To place the switch, or to stack units if you are daisy chaining them, remove the backing material from the bottom of the rubber feet that came with this package, and stick them onto the switch's bottom panel at the corners, as shown in the diagram, below:

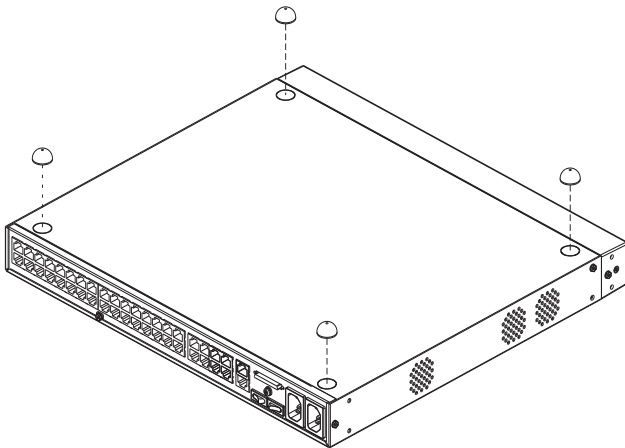

Note: To ensure adequate ventilation, allow at least 5.1 cm on each side, and 12.7cm at the back for power cord and cable clearance.

Rack Mounting

The KM0032 / KM0532 / KM0932 can be mounted in a 19" (1U) rack. The mounting brackets can screw into either the front or the back of the unit so that it can attach to the front or the back of the rack.

Rack Mounting - Front

To mount the unit at the front of the rack, do the following:

1. Remove the two screws at the front of the unit, as shown in the diagram below:

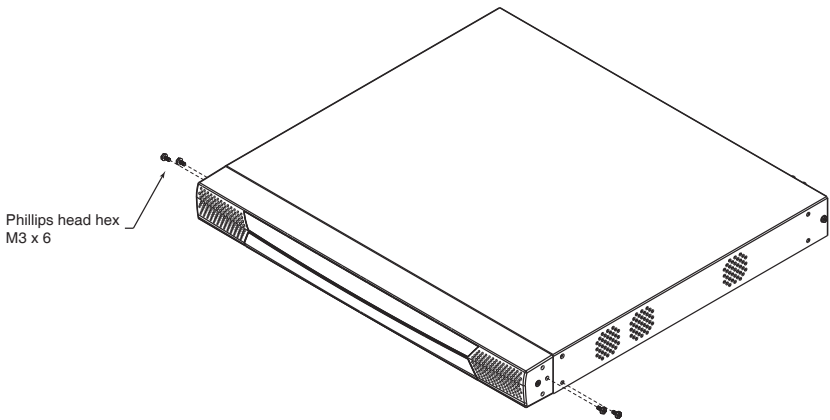

2. Use the M3 x 8 Phillips head hex screws supplied with the rack mount kit to screw the rack mounting brackets into the front of the unit:

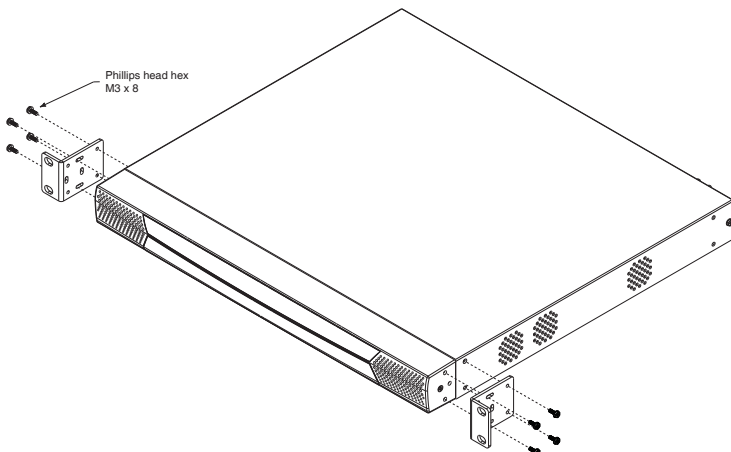

3. Position the device in the front of the rack and align the holes in the mounting brackets with the holes in the rack.
4. Screw the mounting brackets to the rack.

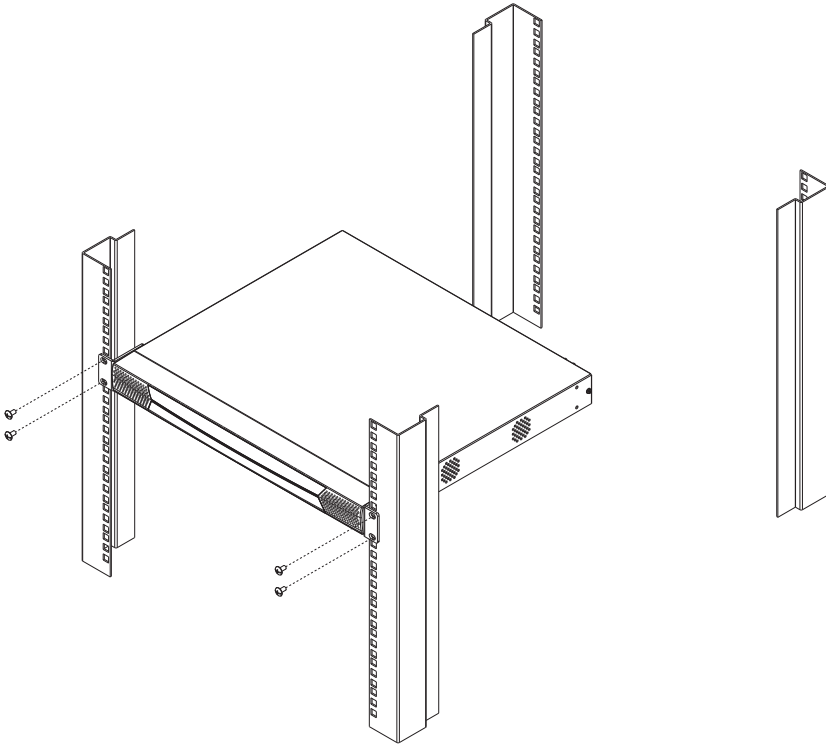

Note: Cage nuts are provided for racks that are not prethreaded.

Rack Mounting - Rear

To mount the unit at the rear of the rack, do the following:

1. Remove the two screws at the rear of the unit:

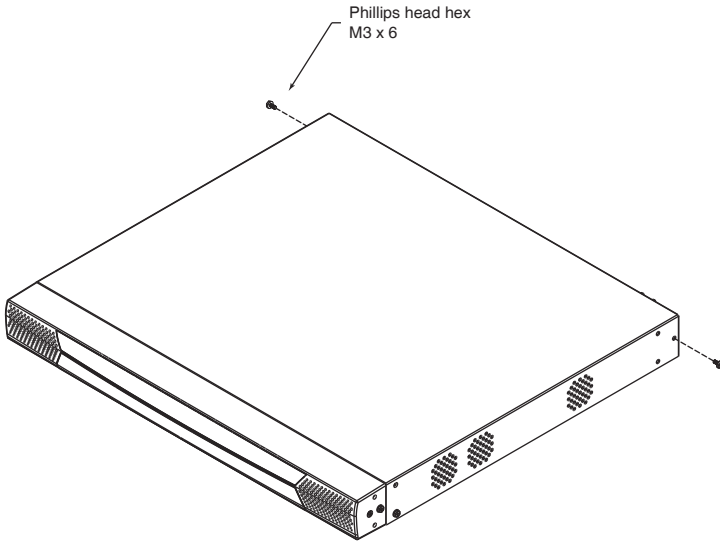

2. Use the M3 x 8 Phillips head hex screws supplied with the rack mounting kit to screw the rack mounting brackets into the rear of the unit:

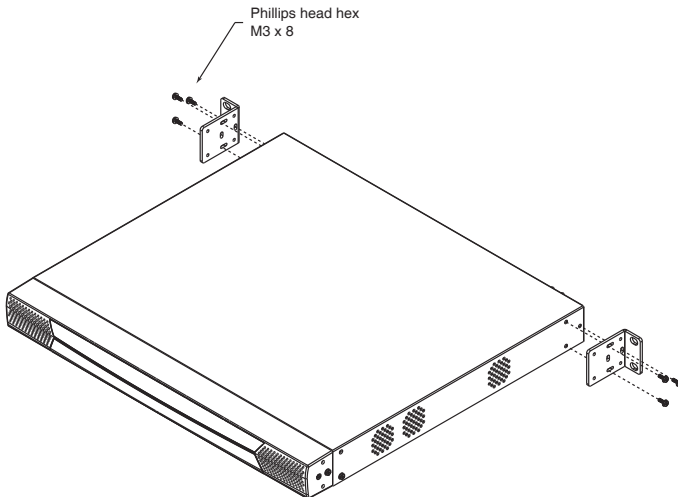

3. Position the device in the rack and align the holes in the mounting brackets with the holes in the rack.
4. Screw the mounting brackets to the rear of the rack.

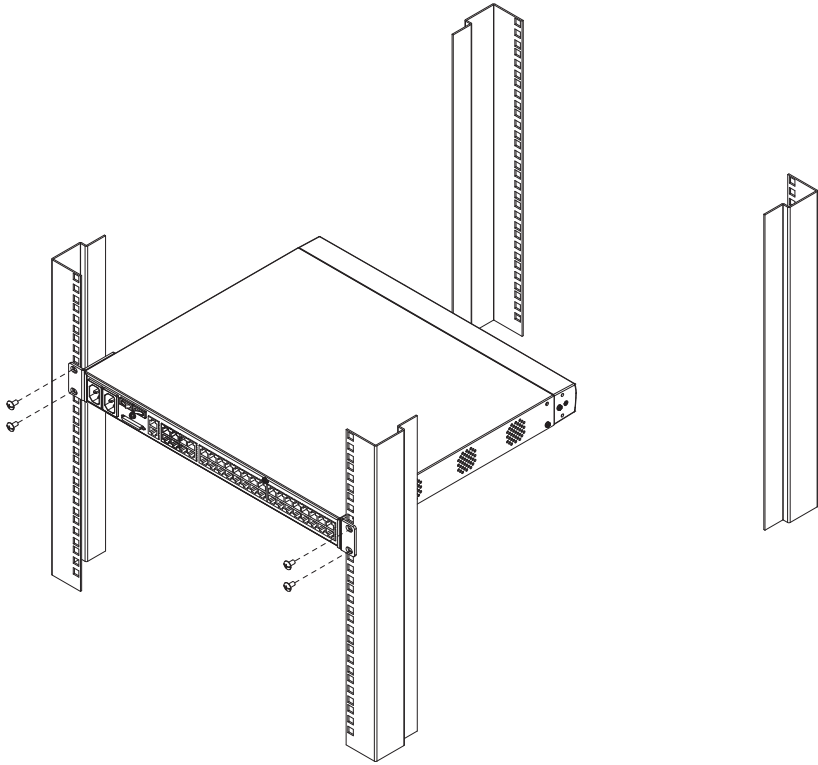

Note: Cage nuts are provided for racks that are not prethreaded.

Grounding

To prevent damage to your installation it is important that all devices are properly grounded.

Use a grounding wire to ground the KM0032 / KM0532 / KM0932 by connecting one end of the wire to the switch's grounding terminal (see page 9), and the other end of the wire to a suitable grounded object.

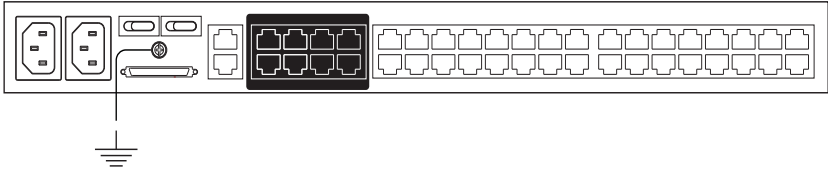

Single Level Installation

In a single level installation, there are no additional KVM switches cascaded or daisy chained down from the first level KVM switch. To set up a single level installation, refer to the diagram on page 19 (the numbers in the diagrams correspond to the numbered steps) and do the following:

1. Connect the KVM console.

Plug your keyboard, mouse, and monitor into their respective ports on the console module. Each console port is marked with an identifying icon (see page 130).

2. Connect the console module to the KM0532 / KM0932.

Use Cat 5e cable to connect the LINE IN 1 or LINE IN 2 port of the console module to one of the Console (User) ports on the KM0532 / KM0932's rear panel.

(Repeat steps 1 and 2 for all KVM consoles that you wish to connect. Up to 5 (KM0532), or 9 (KM0932) KVM consoles may be connected in this fashion (1 port on the front panel, plus 4 or 8 ports on the rear panel.)

Note: The distance between any console module and any KVM adapter cable must not exceed 300 m (1000').

3. Connect the KVM adapter cable to the computer.

Using a KVM adapter cable that is appropriate for the computer you are installing, plug the adapter cable's connectors into their respective ports on the computer (see page 131).

4. Connect the KVM adapter cable to the KM0532 / KM0932.

Use Cat 5e cable to connect the KVM adapter cable to any available KVM port on the KM0532 / KM0932.

(Repeat steps 3 and 4 for all computers that you wish to connect. Up to 32 computers may be connected in this fashion.)

5. Plug a cable from the LAN or WAN into the KM0532 or KM0932's LAN port.

6. Connect a PON unit (Optional)

Use Cat. 5e cable to connect the KM0532 or KM0932's PON port to an SA0142 Adapter. Connect the Adapter to the PON IN port of a PN0108 Power Over the Net™ unit (see page 131).

7. Ground the switch.

Use the grounding wire supplied with this package to ground the unit by connecting one end of the wire to the grounding terminal, and the other end of the wire to a suitable grounded object.

Note: Do not omit this step. Proper grounding helps to prevent damage to the unit from surges or static electricity.

8. Plug the power cords supplied with this package into the KM0532 / KM0932's Power Socket, and then into an AC power source.

Turn on the power to the KM0532 / KM0932.

9. Connect the console module's power adapter to the console module and to an AC power source.

10. Turn on the power to the computers.

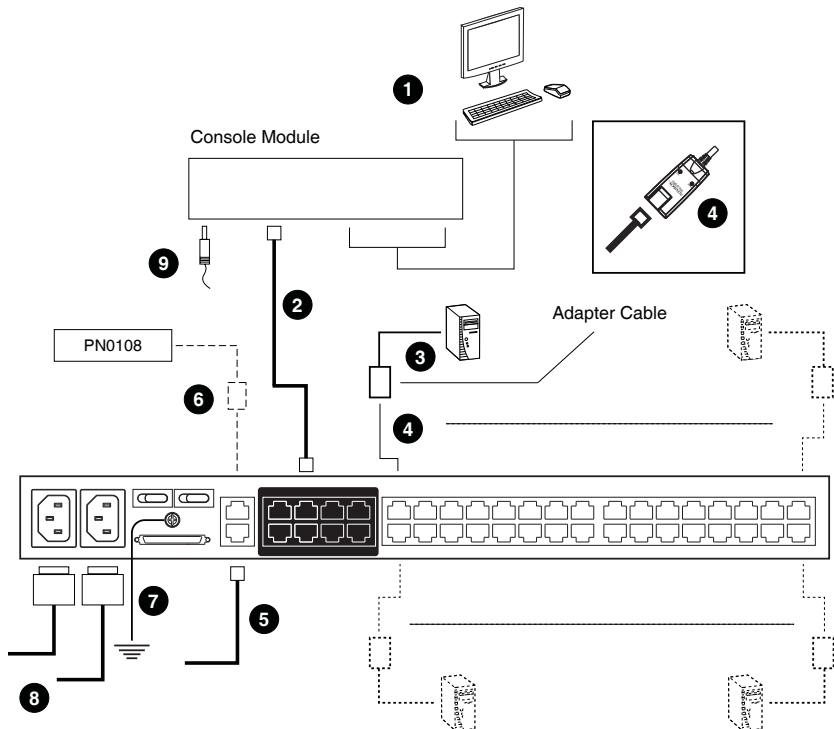
Single Level Installation Diagram

Multilevel Installations

You can greatly expand the number of computers that can be added to your installation by performing a multilevel installation. The KM0532 / KM0932 supports two types of multilevel installation:

- ◆ Cascading
- ◆ Daisy chaining

Overview

Cascading involves using the KVM port(s) of a *parent* KVM switch (one that is above a KVM switch linked down from it) to connect to the Console ports of a *child* KVM switch.

Daisy chaining refers to adding a KVM switch via a dedicated daisy chain port (see the diagram on page 26).

The KM0532 / KM0932 supports both daisy chaining and cascading, providing enormous capacity and flexibility to expand the installation. The following sections provide information and procedures to set up cascaded and daisy chained KVM installations.

Cascading

KM0532 and KM0932 switches support a 3 level cascade for KM0532 / KM0932 units. They support a 1 level cascade for other compatible model KVM switches (see *Supported KVM Switches*, page 129). In other words, slave switches cannot be cascaded from non-KM0532 / KM0932 switches.

The UIs of GUI-compatible cascaded switches are integrated into the KM0532 / KM0932's GUI, so that when the first level consoles bring up the UI, the port directory listing for all of the computers connected to all of the cascaded switches is displayed in the Sidebar tree (see page 35).

-
- Note:**
1. For non GUI-compatible cascaded switches, only the switch appears in the Sidebar tree. Each switch provides its own GUI for switching to its ports after you access it.
 2. A list of supported KVM switches – indicating their GUI compatibility status – is provided in the Appendix on page 129.
-

In cascaded installations, the number of bus connections between a parent and child KVM switch determines the number of users that can simultaneously access the KVM ports of the child switch. A bus connection is established by connecting a KVM port on the parent switch to a Console port on the child switch. The KM0532 / KM0932 supports a maximum of 5 (KM0532) or 9 (KM0932) bus connections for each cascaded KM0532 / KM0932, and usually no more than one for other KVM switches.

In order for all the KVM consoles on the first level KM0532 or KM0932 to be able to access the KVM ports of a cascaded KM0532 / KM0932 at the same time, you must create the maximum number of bus connections between the first level parent switch and the child switch. If the two switches are not directly connected, the intermediary switch(es) must have the maximum number of bus connections to the parent and child switches.

KVM consoles connected to the KVM ports of a cascaded KVM switch can access KVM ports on their cascade level as well as ports on cascaded child switches. They cannot access KVM ports of switches above their cascade level.

Cascading KM0532 / KM0932 Switches

Note: The firmware version of all cascaded KM0532 / KM0932s should match the firmware version of the first level KM0532 / KM0932.

To cascade KM0532 / KM0932 switches refer to the installation diagram on page 23 and do the following:

1. Connect the KVM console to the console module.
 2. Connect the console module to the KM0532 / KM0932.
-

Note: The distance between any console module and any KVM adapter cable, or between the first level and final level KVM switch, may not exceed 300 m (1000').

3. Use Cat 5e cable to connect any KVM port on the parent switch to any of the Console ports on the child switch.
-

Note: 1. The number of KVM consoles connected to the first level switch that can simultaneously access the cascaded switch is limited by the number of Console port connections between the parent and child switches.

2. The distance between any console module and any KVM adapter cable must not exceed 300 m (1000').
-

4. Repeat step 3 for each second level KVM switch that you wish to cascade.
 5. Follow the instructions given for single level installation to connect computers, power cords, etc. (see page 18).
-

Note: It is not necessary to connect cascaded switches to the network. Remote (over the network) administration of cascaded switches are managed through the first level switch.

6. To cascade third level KVM switches, follow the instructions in steps 3, 4, and 5 when cascading them from the second level KVM switches.)
 7. Power on the first level KM0532 / KM0932.
 8. Wait one minute, and then power on each second level KM0532 / KM0932.
 9. Wait one minute, and then power on each third level KM0532 / KM0932.
-

10. Plug the power adapters supplied with the console modules into an appropriate AC power source, and then plug the power adapter cables into the power jacks on the rear of the console modules.
11. Turn on the power to all the computers.

Cascaded KM0532 / KM0932 Installation Diagram

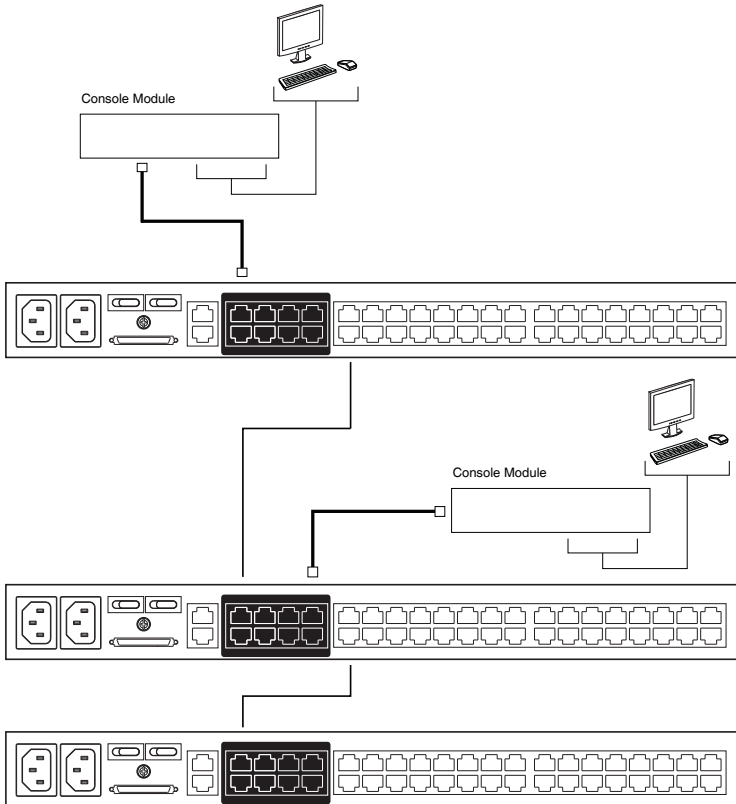

Cascading Other KVM Switches

To cascade KVM switches other than the KM0532 or KM0932, a KVM adapter cable is required. The adapter cable converts the KM0532 / KM0932's port signals to ones appropriate for the connectors on the KVM switch that you are cascading.

Note: Non-KM0532 / KM0932 switches do not support additional cascading. After cascading a non-KM0532 / KM0932 KVM switch, you cannot cascade any more KVM switches from it.

To cascade a KVM switch other than the KM0532 / KM0932:

1. Use Cat 5e cable to connect a KVM port on the KM0532 or KM0932 to a KVM adapter cable appropriate for the KVM switch you are connecting. (See *KVM Adapter Cables*, page 5 for a list of KVM adapter cables and the platforms that they support.)
2. Connect the cables on the KVM adapter cable to the console ports on the KVM switch you are installing.

Other Cascaded KVM Switch Installation Diagram

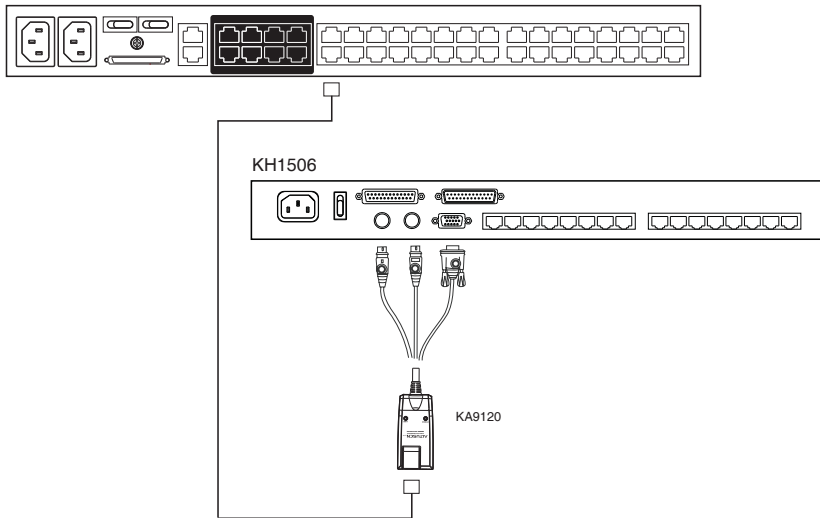

Daisy Chaining

Up to 7 KM0032 Matrix KVM Switches can be daisy chained from the first level KM0532 / KM0932. The KM0932 is capable of supporting nine independent KVM consoles, while the KM0532 is capable of supporting 5 independent KVM consoles. In a complete daisy chained installation, the KVM consoles that belong to the KM0532 / KM0932 can access and control all of the computers on the installation.

Note: You cannot cascade switches from a daisy chained switch.

To set up a daisy chained installation, refer to the diagram on page 26 and do the following:

1. Use a daisy chain cable set (see *Cables*, page 5) to connect the CHAIN OUT port of the parent KM0532 / KM0932 to the CHAIN IN port of the first KM0032.

Note: 1. The maximum distance between any two switches cannot exceed 10 m.

2. The maximum distance between the KM0532 / KM0932 and the last KM0032 in the chain cannot exceed 50 m.
-

2. Follow the instructions given for single level installation to connect computers, LAN, power cords, etc. (see page 18).
3. For any other KM0032 switches you want to add to the chain, use a daisy chain cable (see *Connecting Cables*, page 5), to connect the *Chain Out* port of the parent switch to the *Chain In* port of the child switch.
4. Power on the installation according to the following procedure:
 - a) Power on the first level (KM0532 or KM0932) switch.
 - b) Power on each switch in the chain in turn (second station, then third station, etc.). In each case, wait for the station position to be ascertained and displayed on the Station ID LED before powering on the next station. (The Station ID for the first KM0032 is **01**, the Station ID for the second level KM0032 is **02**, etc.)
 - c) After all the KVM switches are powered on, power on the computers.

Daisy chained Installation Diagram

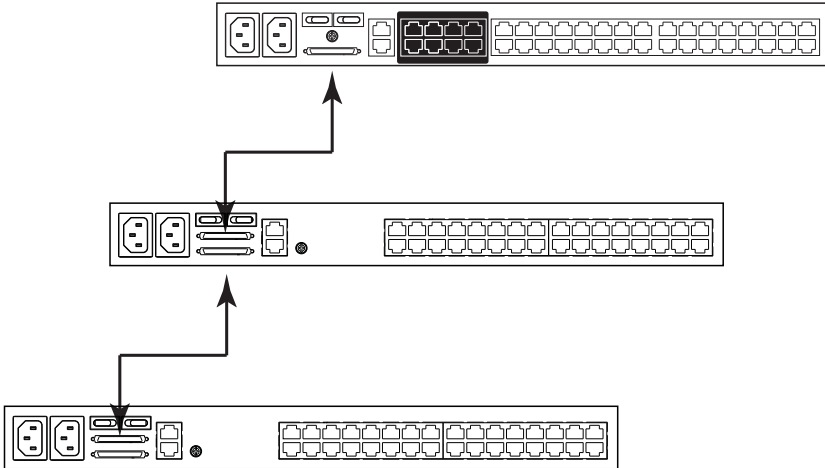

Network Administration

Once the KM0032 / KM0532 / KM0932's network settings have been configured from a local console (see *Network Configuration*, page 29), for convenience, administrative tasks can be performed remotely using a web browser over the internet.

It is not necessary to connect cascaded switches to the network. Remote (over the network) administration of cascaded switches are managed through the of the first level switch.

Topology Considerations

The use of RJ-45 KVM port connectors, combined with Auto Signal Compensation (ASC), allow signals to travel up to 300 meters (1000 feet) and still maintain reliability and high video resolution. This allows the KM0032 / KM0532 / KM0932 installation to take advantage of the internal Cat 5e and Cat 6 wiring built-in to most modern commercial buildings.

Since the data signals are not transmitted in packets, the transmission cannot go through network hubs or switches. Passive components such as patch panels, keystone jacks, patch cables, etc. can be used to channel the traffic, instead.

Chapter 3

Super Administrator Setup

Overview

The KM0032 / KM0532 / KM0932 supports three types of user, as shown in the table, below:

User Type	Role
Super Administrator	Access and manage ports and devices. Manage Users and Groups. Configure the overall installation. Configure personal working environment.
Administrator	Access and manage authorized ports and devices. Manage Users and Groups. Configure personal working environment.
User	Access authorized ports and devices. Manage authorized ports and devices. Configure personal working environment.

This chapter discusses the administrative procedures that the Super Administrator performs.

First Time Setup

Once the KM0032 / KM0532 / KM0932 installation has been cabled up, the Super Administrator needs to set the system up for user operation. This involves setting the network parameters and adding users. The most convenient way to do this for the first time is from one of the consoles.

Note: For remote methods of setting up the network, see *IP Address Determination*, page 124.

After the console has been connected up (see *Single Level Installation*, page 18), and the KM0032 / KM0532 / KM0932 turned on, a login prompt appears on the console monitor:



The screenshot shows a login interface for the KM0932 device. The title bar reads "KM0932 Login". Below the title, there are two input fields: "Username" and "Password". The "Username" field is currently empty, and the "Password" field is also empty. Below the input fields, there are two buttons: "Login" and "Reset".

Since this is the first time you are logging in, key in the default Username: **ADMINISTRATOR**; and the default Password: **password**.

Note: For security purposes, you should change the password. (See *Changing the Super Administrator Login*, page 30 for details.)

After you successfully log in, the Console's GUI appears:

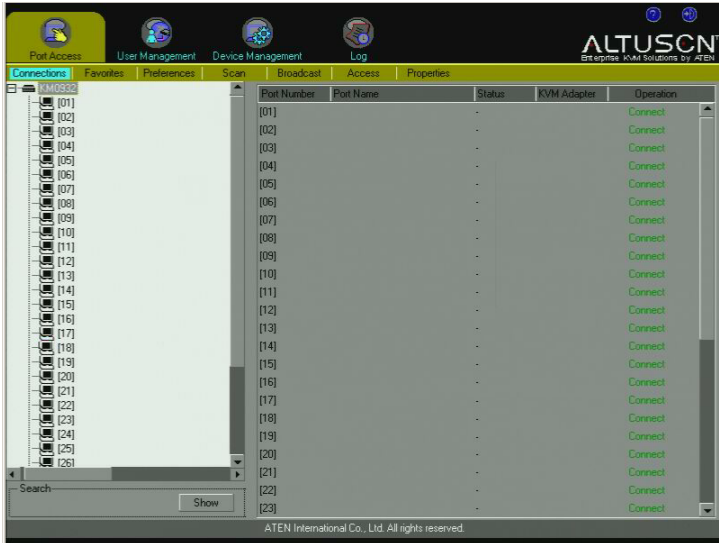

Network Configuration

To set up the network, do the following:

1. Click the **Device Management** tab.
2. Select **Network** on the menu bar. A screen similar to the one below appears:

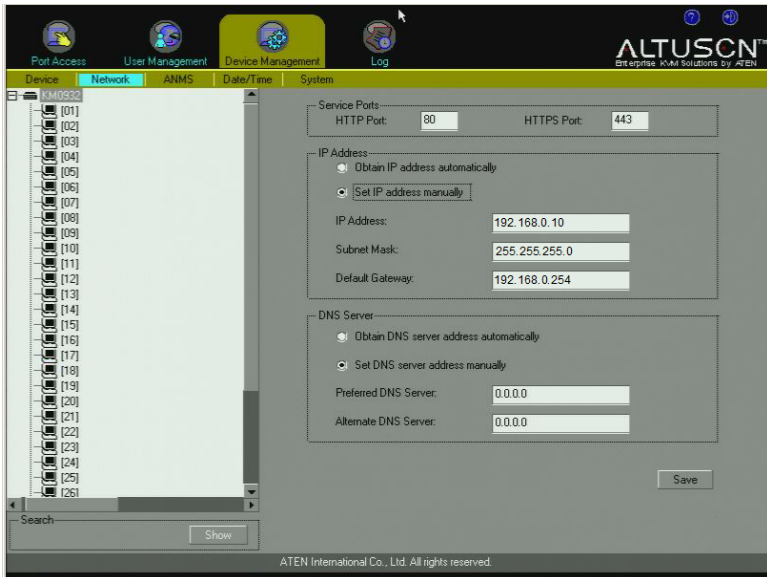

3. Fill in the fields according to the information provided under *Network*, page 44.

Changing the Super Administrator Login

To change the default Super Administrator Password, do the following:

1. Click the **Port Access** tab.
2. Select **Preferences** on the menu bar.

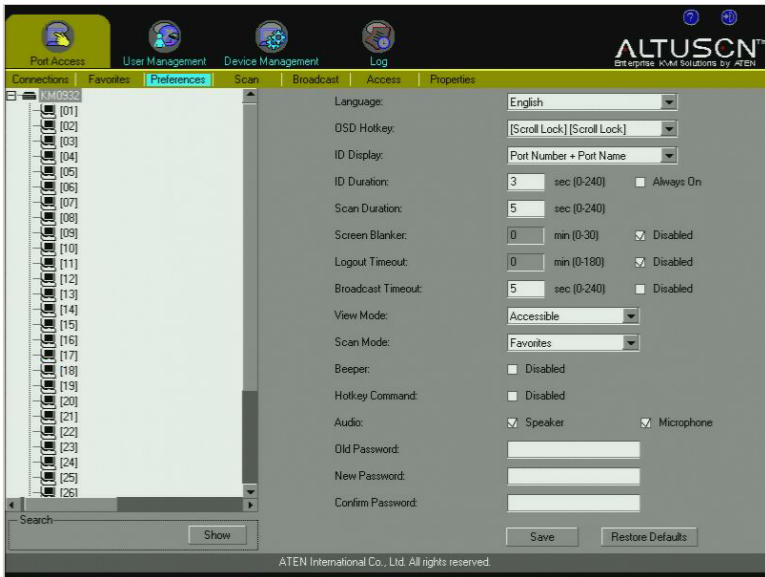

3. Key the old password into the *Old Password* field.
4. Key a unique new password into the *New Password* field.
5. To make sure there was no mistake when entering the new password, key the new password into the *Confirm Password* field.
6. Click **Save**.

Moving On

After setting up the network and changing the default Super Administrator username and password, you can proceed to other administration activities. These include User Management, Device Management, and Firmware Upgrade Maintenance.

These activities can be accomplished either from the console or from a web browser. Choose the approach that suits you best.

Note: Firmware Upgrade Maintenance cannot be performed from the console. You must log in with a web browser for this operation.

This Page Intentionally Left Blank

Chapter 4

Logging In

Overview

The KM0032 / KM0532 / KM0932 switch can be accessed from a local console or an internet browser. Browser access is provided for convenience in performing administrative tasks from a remote location. Port switching and port operation procedures can only be performed from a console.

No matter which method you choose to access the KM0032 / KM0532 / KM0932, the switch's authentication procedure requires you to submit a valid username and password. If you supply an invalid login, the authentication routine will return a *Username and/or Password Error* message. If you see this type of message, log in again with a correct username and password.

Note: If the number of invalid login attempts exceeds an amount specified by the switch's Super Administrator, a timeout period is invoked. You must wait until the timeout period expires before you can attempt to log in again. See *Maximum Login Failures*, page 43 for details.

Console Login

When a console is connected to a powered on KM0532 or KM0932 and there is no user logged in, the KM0532 or KM0932 login screen appears on the display:



The image shows a screenshot of a login interface for a KM0932 switch. The window title is "KM0932 Login". It features two text input fields, one for "Username" and one for "Password". Below these fields are two buttons: "Login" and "Reset". The background is a light gray color.

Simply key in your Username and Password, then click **Login** to bring up the Console UI.

Note: Depending on the switch, the title bar displays KM0532 or KM0932 *Login*. If the switch is unavailable, it says *No device attached*.

Browser Login

The KM0532 or KM0932 can be accessed via an Internet browser from any platform.

Note: 1. The KM0032 is installed as a daisy chained extension to a KM0532 or KM0932, and cannot be accessed directly. It can only be accessed via a login to the switch it is daisy chained from (a KM0532 or KM0932).

2. Browser logins can be used for remote configuration purposes. Port access operations can only be performed from a Console login.

To log into the switch, do the following:

1. Open the browser and specify the IP address of the switch you want to access in the browser's location bar.
2. When a Security *Alert* dialog box appears, accept the certificate – it can be trusted. (See *Trusted Certificates*, page 123, for details.) If other alerts appear, accept them as well.

Once you accept the certificate(s), the login page appears:

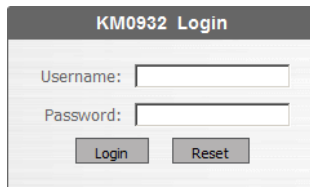

The image shows a web browser window displaying a login page for a KM0932 switch. The page title is "KM0932 Login". It features a "Username:" label followed by a text input field, and a "Password:" label followed by another text input field. Below these fields are two buttons: "Login" and "Reset".

3. Provide your username and password (set by the administrator), then click **Login** to bring up the Browser UI Main Page. For a discussion of the Browser UI Main Page, see page 38.

Chapter 5

The User Interface

Overview

Once you have successfully logged in the KM0532 or KM0932's GUI Main Page appears. The look of the page varies slightly, depending on which method, Console or Web, you used to log in. Each of the interfaces is described in the sections that follow.

The Console UI

Once users log in and are authenticated (see *Logging In*, page 33), the *Console UI Main Page* comes up:

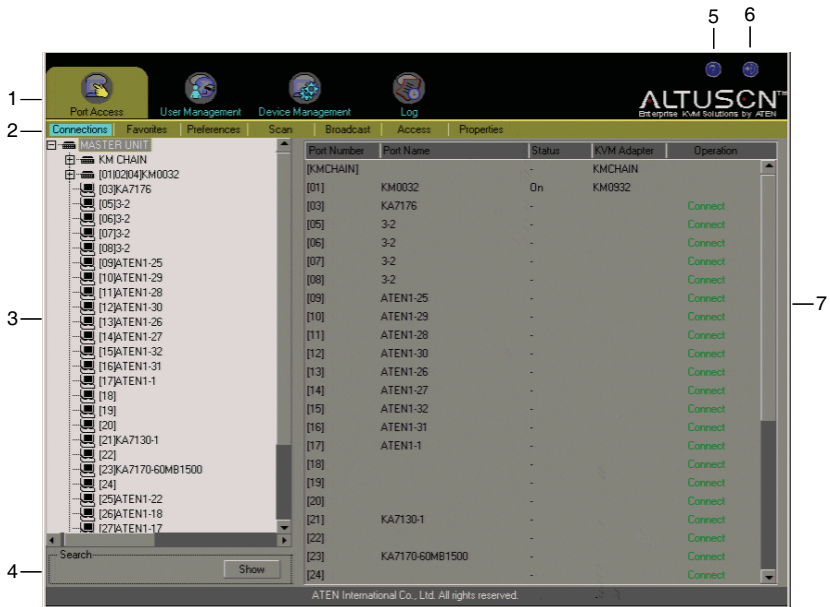

Console UI Page Components

The Console UI page components are described in the table below:

No.	Item	Description
1	Tab Bar	The tab bar contains the KM0032 / KM0532 / KM0932's main operation categories. The items that appear in the tab bar are determined by the user's type, and the authorization options that were selected when the user's account was created.
2	Menu Bar	The menu bar contains operational sub-categories that pertain to the item selected in the tab bar. The items that appear in the menu bar are determined by the user's type, and the authorization options that were selected when the user's account was created.
3	Sidebar	The Sidebar provides a tree view listing of items (ports, users, groups, etc.), that relate to the various tab bar and menu bar selections. Clicking a node in the Sidebar brings up a page with the details that are relevant to it.
4	Show	When the <i>Port Access</i> tab is selected, clicking <i>Show</i> opens a filter panel that lets you expand or narrow the scope of the ports that appear in the Sidebar tree. The Show function is discussed in detail on page 77. Note: Show is only active when the <i>Port Access</i> tab is selected.
5	About	About provides information regarding the switch's current firmware version.
6	Logout	Click this button to log out of your Matrix KVM Switch session.
7	Main Panel	This is your main work area. The screens that appear reflect your tab, menu, and Sidebar choices.

Console UI Keyboard Navigation

You can navigate the Console UI from the keyboard. The hotkey combinations, and their effects, are shown in the table, below:

Focus	Hotkey	Effect
Miscellaneous	F1	Brings up the <i>About</i> screen.
	F8	Logs you out of the session.
The Tab Bar	Ctrl P	Selects the Port Access tab.
	Ctrl U	Selects the User Management tab.
	Ctrl D	Selects the Device Management tab.
	Ctrl L	Selects the Log tab.
The Menu Bar	Tab	After a Tab Bar item is selected, pressing Tab cycles through its Menu Bar items.
Panel Selection	F4	Selects the Sidebar Tree. Note: The tab bar focus switches to the Port Access tab when you make this selection.
	F5	Selects the Main Panel
Sidebar Selection	↑ ↓	When the focus is in the Sidebar, the arrow keys move the selection up and down through the port list. Note: This function is only available under the Port Access tab.
	F3 + ↑ ↓	When you have arrived at the port you want to access, press F3 to bring up a session choice box (see page 76). Use the arrow keys to cycle to your choice, then press [Enter].
Main Panel Selection	Tab	When the focus is in the Main Panel, press Tab to move through the available parameters. For radio buttons press [Enter] to select the choice. For check boxes, press [Enter] to select/deselect the item.
	↑ ↓	For parameters with a list of choices, use the arrow keys cycle you through the parameter choices.
	When all your parameter choices have been made, Tab down to the Save button and press [Enter]	

The Browser UI

For the convenience of remote management, the KM0532 or KM0932 can be accessed with most standard web browsers. Once users log in and are authenticated (see *Browser Login*, page 34), the *Web Browser Main Page* comes up, with the Port Access page displayed:

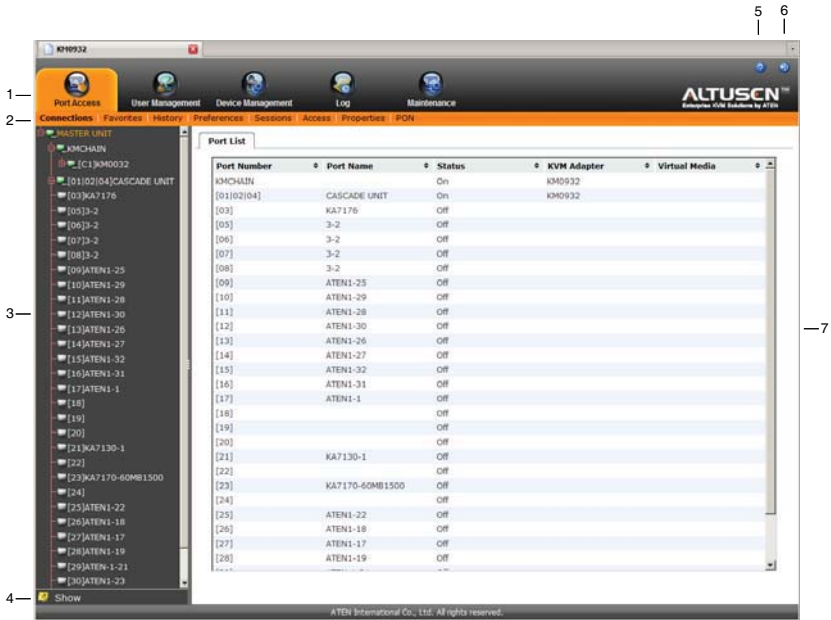

Note: 1. The KM0032 is installed as a daisy chained extension to a KM0532 or KM0932, and cannot be accessed directly. It can only be accessed via a login to the switch it is daisy chained from (a KM0532 or KM0932).

2. The screens depict a Super Administrator's page. Depending on a user's type and permissions, not all of the elements appear.

Browser UI Page Components

The web page screen components are described in the table, below:

No.	Item	Description
1	Tab Bar	The tab bar contains the KM0032 / KM0532 / KM0932's main operation categories. The items that appear in the tab bar are determined by the user's type, and the authorization options that were selected when the user's account was created.
2	Menu Bar	The menu bar contains operational sub-categories that pertain to the item selected in the tab bar. The items that appear in the menu bar are determined by the user's type, and the authorization options that were selected when the user's account was created.
3	Sidebar	The Sidebar provides a tree view listing of ports that relate to the various tab bar and menu bar selections. Clicking a node in the Sidebar brings up a page with the details that are relevant to it.
4	Show	Clicking <i>Show</i> opens a filter panel that lets you expand or narrow the scope of the ports that appear in the Sidebar tree. The Show function is discussed in detail on page 77. Note: Show is active when the <i>Port Access</i> , <i>Device Management</i> , <i>Log</i> , or <i>Maintenance</i> tab is selected.
5	About	About provides information regarding the switch's current firmware version.
6	Logout	Click this button to log out of your Matrix KVM Switch session.
7	Main Panel	This is your main work area. The screens that appear reflect your menu choices and Sidebar node selection.

This Page Intentionally Left Blank

Chapter 6

Device Management

Overview

The *Device Management* page allows super administrators to configure and control overall KM0032 / KM0532 / KM0932 operations.

Note: This page is for super administrators only. Other users can skip this chapter.

Device

When you click the **Device Management** tab, the GUI opens with the *Device* menu page displayed. The page is divided into three main sections: *General*, *Root Device Settings* and *Login Settings*:

Console UI

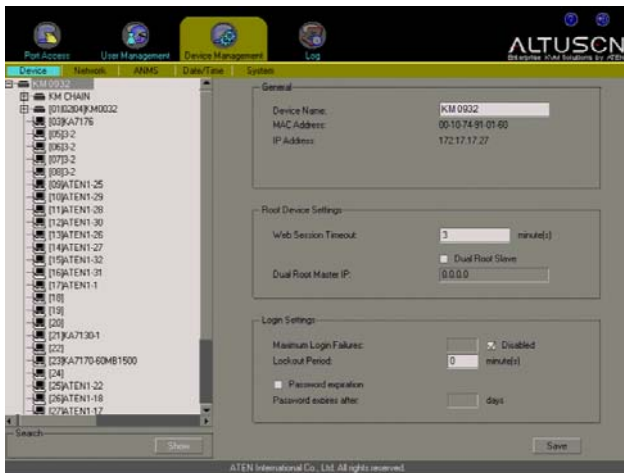

Browser UI

General

Device Name:

MAC Address: 00-10-74-91-01-64

Power 1 Status: OFF

Power 2 Status: ON

Root Device Settings

Web Session Timeout: minutes

Dual Root Slave

Dual Root Master IP:

Login Settings

Maximum Login Failures: Disable

Lockout Period (minutes):

Password expiration

Password expires after (days):

The Device Management settings are described in the table, below:

Item		Meaning
General	Device Name	Allows you to give the switch a name. This can be convenient by helping you to distinguish among the various switches in a large, cascaded installation. Simply key the name of the switch into the text box to the right of the heading.
	MAC Address	Displays the switch's MAC Address.
	IP Address	Displays the switch's IP Address.

Item		Meaning
Root Device Settings	Web Session Timeout	When a user is logged in via a web browser and there is no input from the user for the amount of time set with this function, the user is automatically logged out and will need to log in again.
	Dual Root Slave	Ordinarily the KM0932 supports 9 consoles and 32 ports. You can achieve an 18 console, 64 port configuration by linking two KM0932s together (by connecting them to the same LAN segment) and designating one of them as the master and the other as the slave. If you have set up this kind of configuration and this switch is to be the slave, click to put a check mark in this checkbox, then key the IP address of the master switch into the <i>Dual Root Master IP</i> input box, below it.
	Dual Root Master IP	See the information for <i>Dual Root Slave</i> , above.
Login Settings	Maximum Login Failures	Sets the number of failed login attempts that are allowed before the user is locked out of further attempts to log in.
	Lockout Period	Sets the amount of time a user must wait after being locked out before being able to try logging in again.
	Password Expiration	Click to put a check in this box if you want user passwords to expire after a certain number of days. If the box is unchecked, user passwords do not expire.
	Password expires after (days):	If you enable Password Expiration, key in the number of days a password is valid for. At the end of that period, the user's password expires and must be given a new one.

When you have finished making your settings, click **Save**.

Network

The *Network* page is used to specify the KM0032 / KM0532 / KM0932's network environment.

Console UI

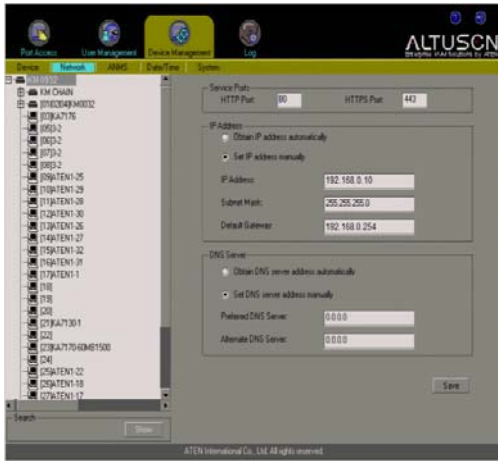

Browser UI

Service Ports	
HTTP Port:	<input type="text" value="80"/>
HTTPS Port:	<input type="text" value="443"/>
IP Address	
<input type="checkbox"/> Obtain IP address automatically <input checked="" type="checkbox"/> Set IP address manually	
IP Address:	<input type="text" value="192.168.0.10"/>
Subnet Mask:	<input type="text" value="255.255.255.0"/>
Default Gateway:	<input type="text" value="192.168.0.254"/>
DNS Server	
<input type="checkbox"/> Obtain DNS server address automatically <input checked="" type="checkbox"/> Set DNS server address manually	
Preferred DNS Server:	<input type="text" value="0.0.0.0"/>
Alternate DNS Server:	<input type="text" value="0.0.0.0"/>
<input type="button" value="Save"/>	

Service Ports

As a security measure, if a firewall is being used, the super administrator needs to specify the port numbers that the firewall will allow. Users must indicate the port number when they log in. If an invalid port number (or no port number) is given, the KM0032 / KM0532 / KM0932 will not be found. An explanation of the fields is given in the table below:

Field	Explanation
HTTP	The port number for a browser login. The default is 80.
HTTPS	The port number for a secure browser login. The default is 443.

Note: 1. If there is no firewall (on an Intranet, for example), it doesn't matter what these numbers are set to, since they have no effect.

2. The service ports cannot have the same value. You must set a different value for each one.

IP Address

The KM0032 / KM0532 / KM0932 can either have its IP address assigned dynamically (DHCP), or it can be given a fixed IP address.

- ◆ For dynamic IP address assignment, select the *Obtain IP Address Automatically* radio button.
- ◆ To specify a fixed IP address, select the *Set IP Address Manually* radio button and fill in the IP address with values appropriate for your network.

DNS Server

- ◆ For automatic DNS Server address assignment, select the *Obtain DNS Server Address Automatically* radio button.
- ◆ To specify the DNS Server address manually, select the *Set DNS Server Address Manually* radio button, and fill in the addresses for the Preferred and Alternate DNS servers with values appropriate for your network.

Note: Specifying at the preferred DNS Server address is mandatory. The alternate DNS Server address is optional.

When you have finished making your Network page settings, click **Save**.

ANMS

The ANMS (Advanced Network Management Settings) page is divided into two panels, as shown, below:

Console UI

The screenshot shows the 'IP Installer' section with three radio buttons: 'Enabled' (selected), 'View Only', and 'Disabled'. Below this is the 'SMTP Settings' section, which includes a checked checkbox for 'Enable report from the following SMTP Server'. Underneath are several input fields: 'SMTP Server', 'Account Name', 'Password', 'From', and 'To'. There is also an unchecked checkbox for 'Server requires authentication'. A 'Save' button is located at the bottom right of the form.

Browser UI

The screenshot shows the 'IP Installer' section with three radio buttons: 'Enabled', 'View Only', and 'Disabled'. Below this is the 'SMTP Settings' section, which includes an unchecked checkbox for 'Enable report from the following SMTP Server'. Underneath are several input fields: 'SMTP Server', 'Account Name', 'Password', 'From', and 'To'. There is also a checked checkbox for 'My server requires authentication'. A 'Save' button is located at the bottom right of the form.

IP Installer

The IP Installer is an external Windows-based utility for assigning IP addresses to the KM0032 / KM0532 / KM0932. See *IP Installer*, page 124 for details.

Click one of the radio buttons to select *Enable*, *View Only*, or *Disable* for the IP Installer utility. See *IP Installer*, page 124, for IP Installer details.

-
- Note:** 1. If you select *View Only*, you will be able to see the KM0032 / KM0532 / KM0932 in the IP Installer's Device List, but you will not be able to change the IP address.
2. For security, we strongly recommend that you set this to *View Only* or *Disable* after use.
-

SMTP Settings

The KM0032 / KM0532 / KM0932 can send reports from an SMTP server. To have the KM0032 / KM0532 / KM0932 email reports from the SMTP server to you, do the following:

1. Click to put a check in the *Enable report from the following SMTP server* checkbox.
2. Key in either the domain name or the IP address of your SMTP server.
3. If your server requires authentication, click to put a check in the *My server requires authentication* checkbox.
4. Key in the appropriate account information in the *Account Name*, *Password*, and *From* fields.

Note: Only one email address is allowed in the *From* field.

5. Key in the email address (addresses) of where you want the report sent to in the *To* field.

Note: If you are sending the report to more than one email address, separate the addresses with a semicolon.

When you have finished making your ANMS page settings, click **Save**.

Association

The Association page is used to associate a PN0108 PON (Power Over the NET™) power outlet with a KVM port on the Matrix KVM Switch. Once an association has been made, the power status of the device attached to the KVM port can be controlled from the Port Access page, rather than having to control the power status by opening a separate web session to the PN0108.

- Note:**
1. This page is only available through the Browser UI.
 2. Use of this feature assumes you have installed a PN0108 and have connected it to a device attached to a KVM switch port on the installation, as shown in the diagram on page 131.
 3. Visit our website for the latest PON firmware and up-to-date information about supported PON models.

Power Management

When you select *Association* on the menu bar, it opens to the Power Management page:

Power Management Summary

Associated Link
Synchronization of Power 1 & 2 On/Off/Reboot:

Associated Power Supply 1:
None

Associated Power Supply 2:
None

Outlet	Name	Threshold Current	Modem Ring Resume	System After AC Back	Kill Power	Confirmation Required	Power On Delay	Power Off Delay
			@	@	@	<input type="checkbox"/>	<input type="text"/> sec	<input type="text"/> sec

Day	Enable/Disable	Shutdown Time (HH:MM)	Restart Time (HH:MM)
Sun	<input type="checkbox"/>	- : -	- : -
Mon	<input type="checkbox"/>	- : -	- : -
Tue	<input type="checkbox"/>	- : -	- : -
Wed	<input type="checkbox"/>	- : -	- : -
Thu	<input type="checkbox"/>	- : -	- : -
Fri	<input type="checkbox"/>	- : -	- : -
Sat	<input type="checkbox"/>	- : -	- : -

The page is organized into three main sections, as described in the table, below:

Page Section	Description
Top	This section is where you associate the PN0108 power outlet(s) with a KVM port on the Matrix KVM Switch.
Middle	This section is where you set up the power management configuration for each outlet. Refer to the <i>Outlet Configuration</i> section of the PN0108 User Manual's <i>Administration</i> chapter for configuration details.
Bottom	This section is where you set up a scheduled Power On/Off configuration for the outlet. Refer to the <i>Schedule</i> section of the PN0108 User Manual's <i>Administration</i> chapter for setup details.

To associate a PON outlet with a KVM switch port, do the following:

1. In the Sidebar tree, select the KVM switch port you want to associate with the PON outlet.

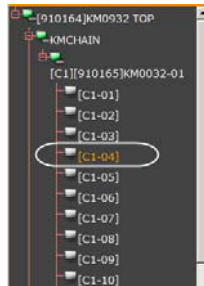

2. Drop down the *Associated Power Supply* 1 list to select the outlet you want to associate with the port, then click the **Association** button just to the right of the selection box. The outlet ID and Name appear in the power management table, in the Middle section.

Associated Link

Synchronization of Power 1 & 2 On/Off/Reboot:

Associated Power Supply 1: 01-D_OutletD Association

Associated Power Supply 2: None Association

Outlet	Name	Threshold Current	Modem Ring Resume	System After AC Back	Kill Power	Confirmation Required	Power On Delay	Power Off Delay
01-D	OutletD		e	e	e	<input type="checkbox"/>	sec	sec
Day	Enable/Disable	Shutdown Time (HH:MM)		Restart Time (HH:MM)				
Sun	<input type="checkbox"/>	:	:	:	:	:	:	:
Mon	<input type="checkbox"/>	:	:	:	:	:	:	:
Tue	<input type="checkbox"/>	:	:	:	:	:	:	:
Wed	<input checked="" type="checkbox"/>	14	: 34	14	: 37	:	:	:
Thu	<input type="checkbox"/>	:	:	:	:	:	:	:
Fri	<input type="checkbox"/>	:	:	:	:	:	:	:
Sat	<input type="checkbox"/>	:	:	:	:	:	:	:

3. (Optional) If the device connected to the KVM switch port has a dual power supply, and if you wish to associate a second outlet port with the secondary power supply, drop down the *Associated Power Supply 2* list to select the outlet you want to associate with the port, then click the **Associate** button just to the right of the *Associated Power Supply 2* selection box.
4. (Optional) If you have associated two power supply outlets, and you want to synchronize the On/Off/Reboot operations for both power supplies, click to put a check mark in the *Synchronization of Power 1 & 2 ON/OFF/Reboot* checkbox.
5. Set the Power Configuration and Schedule settings according to the information provided in the *Connection* and *Schedule* sections of the PN0108 User Manual's Administration chapter.
6. Click **Save** (at the bottom of the page).

Now, you can manage the configuration and schedule settings of the device by selecting its KVM port on this page (Device Management → Association).

You can also power control the device when you select its port from the Port Access → Connections page.



Summary

Clicking the *Summary* tab brings up a page similar to the one below:

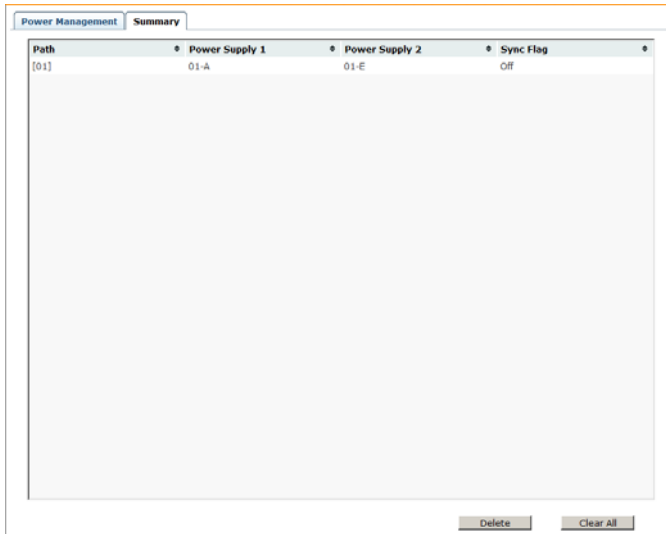

Path	Power Supply 1	Power Supply 2	Sync Flag
[01]	01-A	01-E	Off

Buttons: Delete, Clear All

This page provides a sorted listing of the power associations that have been made via the Power Management page.

- ◆ You can change the sort order by clicking the column headings.
- ◆ To remove a power association, select it and click **Delete**.
- ◆ To remove all of the power associations, click **Clear All**.

Date/Time

Console UI

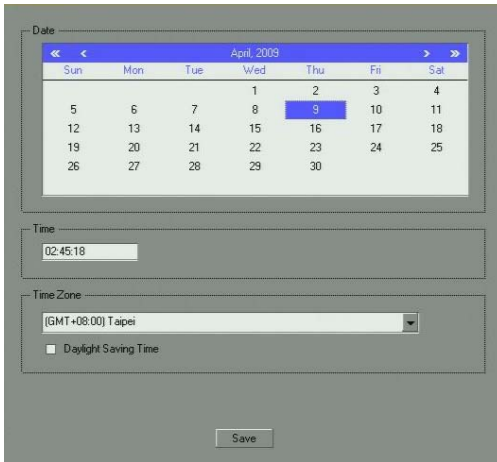

The screenshot displays a configuration window for Date/Time settings. At the top, there is a 'Date' section with a calendar for April 2009. The calendar shows days from Sun to Sat, with the 9th of April highlighted. Below the calendar is a 'Time' section with a text input field containing '02:45:18'. Underneath is a 'Time Zone' section with a dropdown menu showing '(GMT+08:00) Taipei' and an unchecked checkbox for 'Daylight Saving Time'. A 'Save' button is located at the bottom center of the window.

Set the parameters according to the information below.

Date

- ◆ Click << or >> to move backward or forward by one year increments.
- ◆ Click < or > to move backward or forward by one month increments.
- ◆ In the calendar, click on the day.

Time

To set the time, use the 24 hour HH:MM:SS format.

Time Zone

- ◆ To establish the time zone that the KM0032 / KM0532 / KM0932 is located in, drop down the *Time Zone* list and choose the city that most closely corresponds to where it is at.
- ◆ If your country or region employs Daylight Saving Time (Summer Time), check the corresponding checkbox.

When you have finished making your Date/Time page settings, click **Save**.

Browser UI

Current System Time	
Date (YYYY-MM-DD):	2009-07-23
Time (HH:MM:SS):	16:23:10
New System Time	
<input type="radio"/> Synchronize with computer time	
Date (YYYY-MM-DD):	2009-07-23
Time (HH:MM:SS):	16:20:23
<input type="radio"/> Set manually	
Date (YYYY-MM-DD):	2009-07-23
Time (HH:MM:SS):	
<input checked="" type="radio"/> Synchronize with NTP server	
<input type="checkbox"/> Using default NTP server	
Primary NTP Server:	10.3.42.147
Alternate NTP Server:	10.3.166.10
KM0932 Time Zone	
Time Zone:	(GMT+08:00) Taipei
<input type="checkbox"/> Daylight Savings Time	

An explanation of the settings found on this page are as follows:

Current System Time

This section displays the time and date that the switch is currently set to. The time and date fields are for information purposes and cannot be edited.

Note: In the Browser UI, the system time displays the time relative to the timezone that the web browser session originates from – not the timezone of the Matrix KVM Switch. If the web browser session originates from a timezone that is different from the switch's timezone, the time shown in the display will be different from the switch's time.

New System Time

Use these fields to change the switch's time and date settings, as follows:

- ◆ To set the switch's time and date to match the time and date of the computer you are logged in on, select the **Synchronize with computer time** radio button.

Note: Your computer's time and date are displayed in the fields just below the heading. These fields are for information purposes only.

- ◆ To set the time and date to values of your choosing, select the **Set manually** radio button and key the settings into their appropriate fields using the *HH:MM:SS* and *YYYY-MM-DD* formats.
- ◆ To have the time automatically synchronized to a network time server, select the **Synchronize with NTP server** radio button:
 - ◆ If you want to use your network's default time server, put a check in the *Using default NTP server* checkbox.
 - ◆ If you want to specify a time server, make sure that the *Using default NTP server* checkbox is unchecked, then key in the IP address of the time server of your choice in the *Primary NTP Server* field. If you want to configure an alternate time server, key in the IP address of the time server in the *Alternate NTP Server* field.

Time Zone

The Time Zone settings are the same as the ones described for the Console UI on the preceding page.

System

Console UI

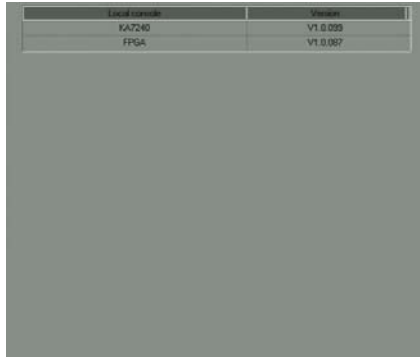

Device	Firmware
KA7240	V1.0.099
FFS4	V1.0.007

The Console UI's *System* page provides system information, including the firmware version, regarding the KM0032 / KM0532 / KM0932 and the modules connected to it.

Browser UI

Station ID	Port Path	Type	Device	Firmware
910164	[01]	Station	KM0932	V1.0.097
910164	[01]	Console	KA7240	V1.1.102
910164	[01]	Port	KM0932	V1.0.097
910164	[C1-01]	Station	KM0032	V1.0.097
910164	[C1-01]	Console	KM0932	V1.0.097
910164	[01-01]	Station	KM0932	V1.0.097
910164	[01-01]	Console	KM0932	V1.0.097

The Browser UI's *System* page provides detailed information about the devices (KVM switches, Console Modules, and KVM Adapter Cables) deployed on the matrix KVM switch installation.

Note: You can change the sort order of the displayed items by clicking on the column headings.

This Page Intentionally Left Blank

Chapter 7

User Management

Overview

The *User Management* page allows super administrators and administrators to create, modify, and delete users and groups, as well as assign device authorizations to them. Up to 1024 accounts and 256 groups can be created.

- Note:**
1. This page is for super administrators and administrators only. Ordinary users can skip this chapter.
 2. There is a pre-installed account that the super administrator can use to log in for the first time. The Username is *ADMINISTRATOR*; the password is *password*. For security purposes, we strongly recommend changing the password to something unique.
-

Accounts

When you click the **User Management** tab, the GUI opens with the *Accounts* menu page displayed. When you access the User Management page for the first time, a screen similar to the one below appears:

Console UI:

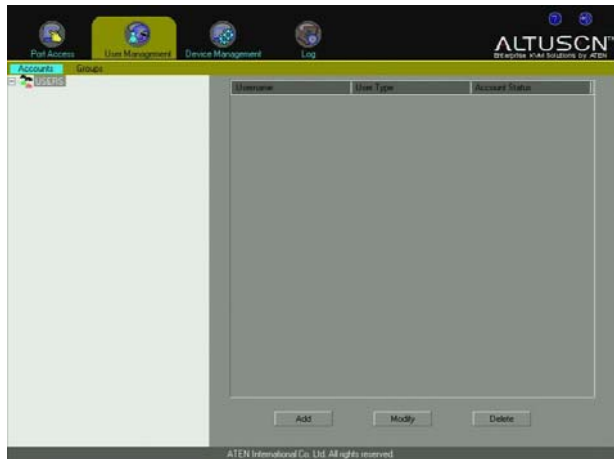

Browser UI:

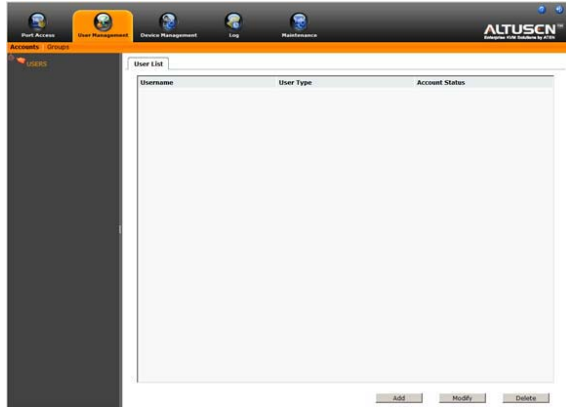

The page is organized into two main areas. All users are listed in the Sidebar at the left of the page. The large panel at the right also lists the users, but provides more detailed information at-a-glance for each.

Adding Users

To add a user, do the following:

1. Select *Accounts* on the menu bar.
2. Select *Users* in the Sidebar.
3. Click **Add** at the bottom of the main panel. The User page opens, with the *User* tab selected:

Console UI:

Browser UI:

4. Enter the required information for the user in the appropriate fields. A description of each of the fields is given in the table, below:

Field	Description
Username	A minimum of 1 and a maximum of 15 characters is allowed.
Password	A minimum of 1 and a maximum of 15 characters is allowed.
Confirm Password	To be sure there is no mistake in the password, you are asked to enter it again. The two entries must match.
User Type	<p>There are three categories: Super Administrator, Administrator and User. There is no limitation on the number of accounts that can be created in each category (although the total number of accounts for all categories combined cannot exceed 1024).</p> <ul style="list-style-type: none"> ◆ The super administrator is responsible for the overall installation configuration and maintenance; user management; and device and port assignments. ◆ Administrators have user management and configuration privileges. ◆ Users can access the devices and ports assigned to them by the super administrators and administrators.

Field	Description
Permissions	<ul style="list-style-type: none"> ◆ <i>Virtual Media</i> is only available to users. It gives them permission to use the KM0032 / KM0532 / KM0932's virtual media function. See <i>Vm Mount</i>, page 80 for details. ◆ <i>Power Management</i> is only available to users. It allows them to access a Power on the Net™ device connected to the switch's PON port.
Status	<p>Status allows you to control the user's account and access to the installation, as follows:</p> <ul style="list-style-type: none"> ◆ <i>Disable Account</i> lets you suspend a user's account without actually deleting it, so that it can be easily reinstated in the future. ◆ If you don't want to limit the time scope of the account, select <i>Account never expires</i> ◆ If you want to limit the amount of time that the account remains in effect, select <i>Account expires on</i>, and key in the expiration date. ◆ To require a user to change his password at the next logon, select <i>User must change password at next logon</i>. This can be used by the administrator to give the user a temporary password to log in for the first time, and then let the user set the password of his choice for future logins. ◆ To make a password permanent, so that the user cannot change it to something else, select <i>User cannot change password</i>. ◆ For security purposes, administrators may want users to change their passwords from time to time. If not, select <i>Password never expires</i>. This allows users to keep their current passwords for as long as they like.

5. When your selections have been made click **Save**. When the operation completes, the new user appears in the Sidebar and the main panel. The main panel also shows the user's type, and whether the account status is currently active or has been disabled.

Note: The sort order of the information displayed in the Console UI main panel can be changed by clicking the column headings.

Modifying User Accounts

To modify a user account, do the following:

1. Select *Accounts* on the menu bar.
2. In the Sidebar, click the user's name

– or –

In the main panel, select the user's name, then click **Modify**.

3. In the *User* page that comes up, make your changes, then click **Save**.

Deleting User Accounts

To delete a user account do the following:

1. Select *Accounts* on the menu bar.
2. In the main panel, select the user's name, then click **Delete**.
3. In the confirmation popup that appears, click **OK**.

Groups

Groups allow administrators to easily and efficiently manage users and devices. Since device access rights apply to anyone who is a member of the group, administrators need only set them once for the group, instead of having to set them for each user individually. Multiple groups can be defined to allow some users access to specific devices, while restricting other users from accessing them.

Note: Only Users can belong to groups. Super Administrators and Administrators cannot be assigned to groups.

Creating Groups

To create a group, do the following:

1. Select *Groups* on the menu bar.
2. Select *Groups* in the Sidebar.
3. Click **Add** at the bottom of the main panel. The Group notebook opens, with the *Group* tab selected:

Console UI:

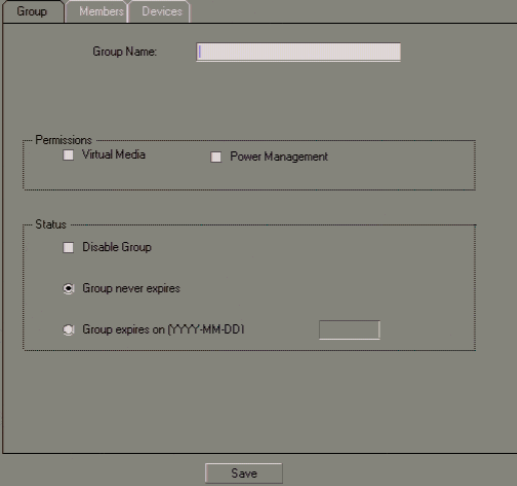

The screenshot shows a web-based console interface for creating a group. At the top, there are three tabs: "Group" (selected), "Members", and "Devices". Below the tabs is a "Group Name:" label followed by a text input field. Underneath is a "Permissions" section with two checkboxes: "Virtual Media" and "Power Management". Below that is a "Status" section with three radio button options: "Disable Group", "Group never expires" (which is selected), and "Group expires on (YYYY-MM-DD)" followed by a date input field. At the bottom center of the form is a "Save" button.

Browser UI:

4. Enter the required information in the appropriate fields. A description of each of the fields is given in the table below:

Field	Description
Group Name	A minimum of 1 and a maximum of 16 characters is allowed.
Permissions	<ul style="list-style-type: none"> ◆ <i>Virtual Media</i> is only available to users. It gives them permission to use the KM0032 / KM0532 / KM0932's virtual media function. See <i>Vm Mount</i>; page 80 for details. ◆ <i>Power Management</i> allows users to access a Power on the Net™ device connected to the switch's PON port. <p>Note: If a user has permissions in addition to the ones assigned to the group, the user keeps those permissions in addition to the group ones.</p>
Status	<p>Status allows you to control the group's access to the installation, as follows:</p> <ul style="list-style-type: none"> ◆ <i>Disable Group</i> lets you suspend a group's access without actually deleting it, so that it can be easily reinstated in the future. ◆ If you don't want to limit the time scope of the group, select <i>Group never expires</i> ◆ If you want to limit the amount of time that the group remains in effect, select <i>Group expires on</i>, and key in the expiration date.

5. When your selections have been made click **Save**. When the operation completes, the new group appears in the Sidebar and the main panel. The main panel also shows whether the group status is currently active or has been disabled.

Note: The sort order of the information displayed in the Console UI main panel can be changed by clicking the column headings.

Modifying Groups

To modify a group, do the following:

1. Select *Groups* on the menu bar.
2. In the *Group* list, click the group's name
– or –
In the main panel, select the group's name, then click **Modify**.
3. In the *Group* notebook that comes up, make your changes, then click **Save**.

Deleting Groups

To delete a group do the following:

1. Select *Groups* on the menu bar.
2. In the main panel, select the group's name, then click **Delete**.
3. In the confirmation popup that appears, click **OK**.

Users and Groups

There are two ways to assign users to – and remove users from – groups: from the Users menu; and from the Group menu.

Note: Before you can assign users to groups, you must first create them. See *Adding Users*, page 58 for details.

Assigning Users to a Group From the User Menu

To assign a user to a group from the User menu, do the following:

1. Select *Accounts* on the menu bar.
2. In the Sidebar, click the user's name

– or –

In the main panel, select the user's name, then click **Modify**.

3. In the page that comes up, select the *Groups* tab. A screen, similar to the one below, appears:

Console UI:

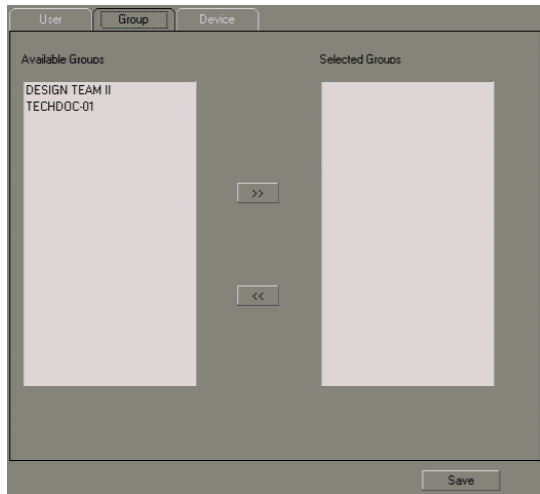

Browser UI:

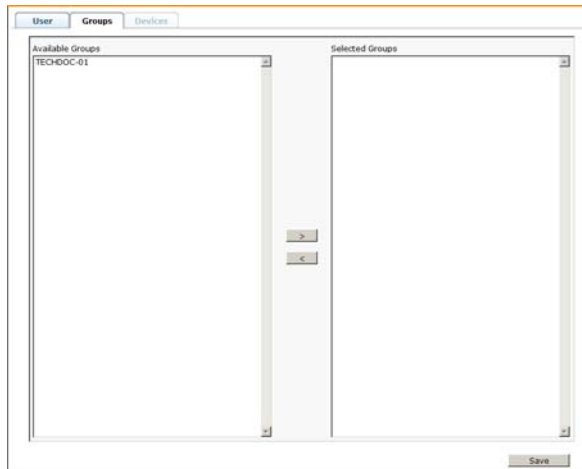

4. In the *Available Groups* column, select the group that you want the user to be in.
5. Click the **Right Arrow** to put the group's name into the *Selected Groups* column.
6. Repeat the above for any other groups that you want the user to be in.
7. Click **Save** when you are done.

Removing Users From a Group From the User Menu

To remove a user from a group from the User menu, do the following:

1. Select *Accounts* on the menu bar.
2. In the Sidebar, click the user's name
– or –

In the main panel, select the user's name, then click **Modify**.

3. In the page that comes up, select the *Groups* tab. A screen, similar to the one below, appears:

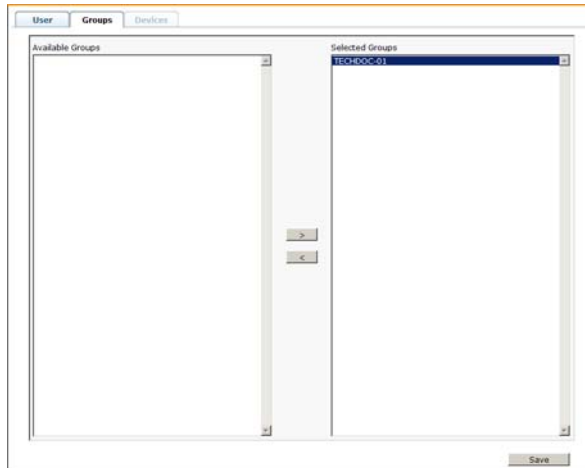
Console UI:**Browser UI:**

4. In the *Selected Groups* column, select the group that you want to remove the user from.
5. Click the **Left Arrow** to remove the group's name from the *Selected Groups* column. (It goes back into the *Available Groups* column.)
6. Repeat the above for any other groups that you want to remove the user from.
7. Click **Save** when you are done.

Assigning Users to a Group From the Group Menu

To assign a user to a group from the Group menu, do the following:

1. Select *Groups* on the menu bar.
2. In the Sidebar, click the group's name

– or –

In the main panel, select the group's name, then click **Modify**.

3. In the page that comes up, select the *Members* tab. A screen, similar to the one below, appears:

Console UI:

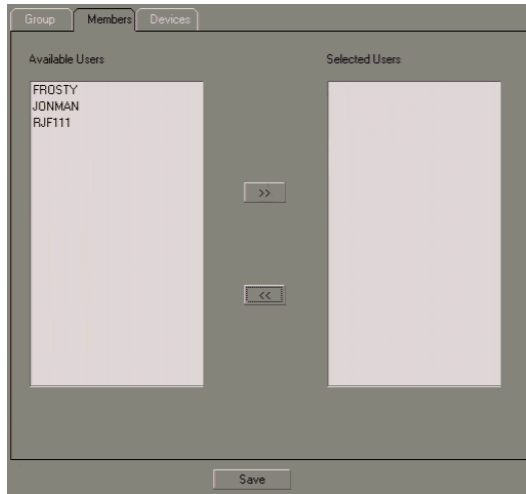

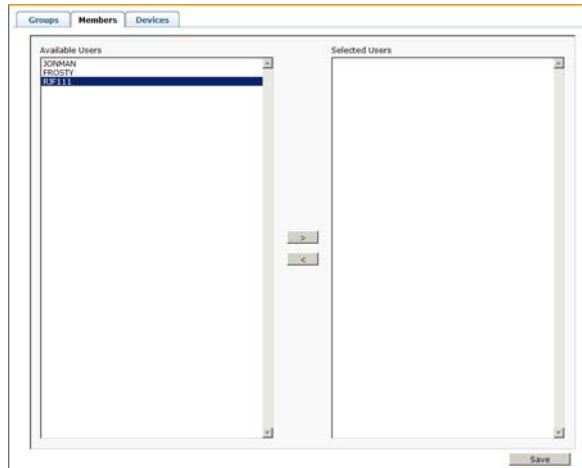
Browser UI:

4. In the *Available Users* column, select the user that you want to be a member of the group.
5. Click the **Right Arrow** to put the user's name into the *Selected Users* column.
6. Repeat the above for any other users that you want to be members of the group.
7. Click **Save** when you are done.

Removing Users From a Group From the Group Menu

To remove a user from a group from the Group menu, do the following:

1. Select *Groups* on the menu bar.
2. In the Sidebar, click the group's name

– or –

In the main panel, select the group's name, then click **Modify**.

3. In the page that comes up, select the *Members* tab. A screen, similar to the one below, appears:

Console UI:

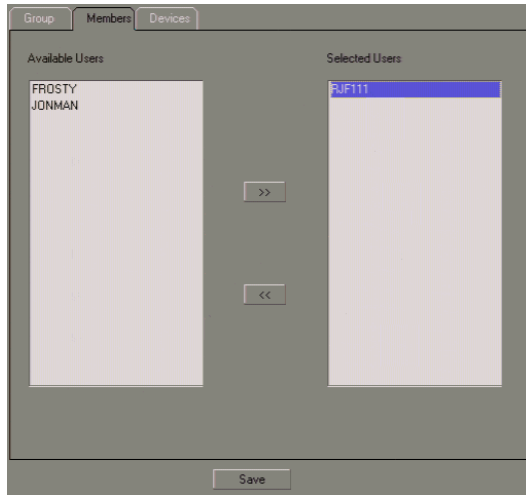

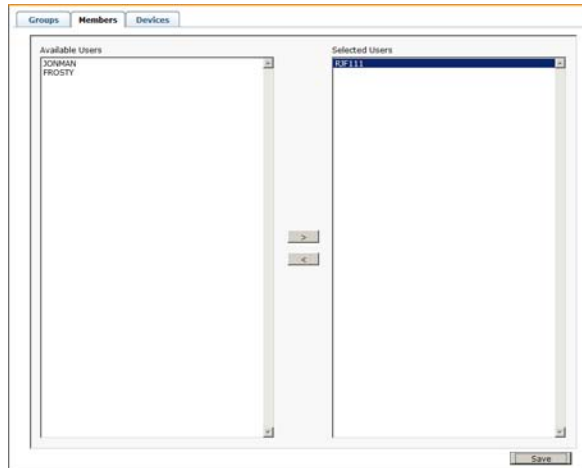
Browser UI:

4. In the *Selected Users* column, select the user that you want to remove from the group.
5. Click the **Left Arrow** to remove the user's name from the *Selected Users* column. (It goes back into the *Available Users* column.)
6. Repeat the above for any other users that you want to remove from the group.
7. Click **Save** when you are done.

Device Assignment

When a user logs in to the Matrix KVM Switch, the GUI comes up with the *Port Access* page displayed. All the ports that the user is permitted to access are listed in the Port Selection panel at the left of the page. Access permissions for those ports and the devices connected to them are assigned on a port-by-port basis from the *User* or *Group* list of the User Management page.

Assigning Device Permissions From the User Menu

To assign a device permissions to a user from the User menu, do the following:

1. Select *Accounts* on the menu bar.
2. In the *Sidebar*, click the user's name
– or –

In the main panel, select the user's name, then click **Modify**.

3. In the page that comes up, select the *Devices* tab. A screen, similar to the one below, appears:

Console UI:

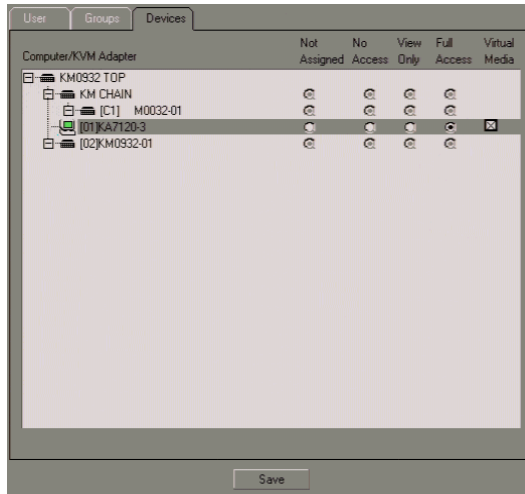

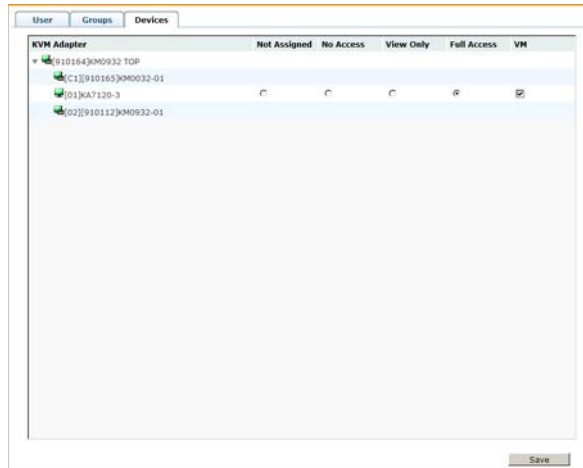
Browser UI:

Note: Only devices that are powered on appear in the list.

- Switches and ports are listed in the left hand column. Select the port that you wish to configure the permissions for, then click a radio button to set the permissions according to the information in the table, below:

Heading	Description
Not Assigned	No permission setting is specifically assigned for the user. If a user belongs to a group that has rights to the device, however, the port will appear in the user's Sidebar tree and the user can access the device according to the rights that belong to the group.
No Access	No access rights - the user has no rights to view or perform any operations on the server connected to the port. The port does not show up in the user's Sidebar or in the list in the main panel. With this setting, even if a user belongs to a group that has rights to the device, the user will still not see the device in the Sidebar or list, and will not be able to access it.
View Only	The user can only view the remote screen; he cannot perform any operations on it.
Full Access	The user can view the remote screen and can perform operations on the remote system from his keyboard and monitor. If this setting is enabled, the <i>Virtual Media</i> setting checkbox becomes active.
Virtual Media	Click to put an X in the box to enable the user to use the virtual media function on this port. See <i>Vm Mount</i> , page 80 for details on mounting virtual media devices.

5. Repeat the procedure for each port you wish to assign.
6. When you have finished making your choices, click **Save**.
7. In the confirmation popup that appears, click **OK**.

Assigning Device Permissions From the Group Menu

To assign a device permissions to a Group of users, do the following:

1. Select *Groups* on the menu bar.
1. In the *Sidebar*, click the group's name
– or –

In the main panel, select the group's name, then click **Modify**.

2. In the *Groups* page that comes up, select the *Devices* tab.
3. The screen that comes up is the same one that appears in the User menu, except that there isn't a *No Access* setting on this page.

The difference between using this page and the User page, is that whatever settings you make apply to all members of the group instead of just one individual member.

Make your device assignments according to the information described under *Assigning Device Permissions From the User Menu*, page 72.

Chapter 8 Port Access

Overview

When you log in to the switch the Port Access page comes up with the *Connections* page displayed.

Console UI



Browser UI

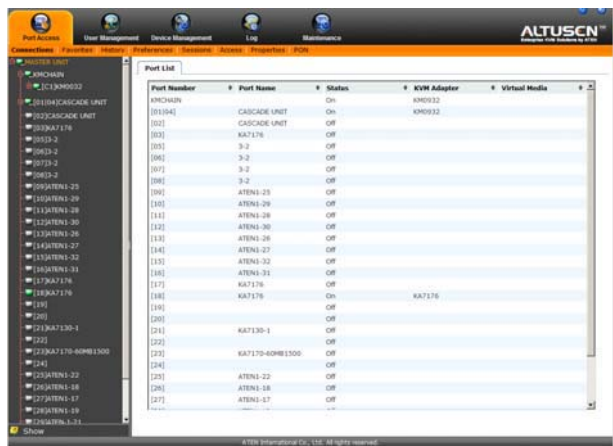

Page Layout

The Port Access page is organized into several main areas:

- ♦ All the ports that a user is permitted to access are listed in the Port Selection Sidebar at the left of the page.
- ♦ At the bottom of the Sidebar, there is a *Show* button that gives users control over which of their ports appear in the tree
- ♦ The main panel provides a detailed listing of each port, as well as a means of accessing the ports.

The Port Selection Sidebar

All switches and their ports that a user is allowed to access – including cascaded switches and their ports – are listed in a tree structure in the Sidebar at the left of the screen:

The Port Selection Tree

- ♦ Users are only allowed to see the switches and ports that they have access rights for.
- ♦ Ports and child switches may be nested under their parent switches. Click the + in front of a switch to expand the tree and see the nested ports. Click the - to collapse the tree and hide the nested ports.
- ♦ A port's ID number is displayed in brackets next to the port icon. For convenience the ports can be named (see *Configuring Port Properties*, page 90 for details).
- ♦ Switches and ports that are on line have their monitor screen icons lit green; the monitor screens are gray for devices and ports that are offline.
- ♦ To access a port, double click its icon. Port operation details are discussed in Chapter 11, *Console Port Operation*.
- ♦ When you right click on a port in the Console UI tree, a small box pops up offering a choice to open a KVM session to the port, or to mount a virtual device on it. Double click **KVM** to open the KVM session to the server connected to the port; double click **VM Mount** to mount a virtual device connected to the console module's USB port on the server connected to the port (see page 80 for details),.

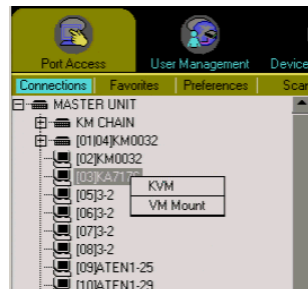

- When you right click on a port in the Browser UI, a small button pops up offering to let you add the port to your *Favorites* list, and, if the port has been named, to erase the port's name. Click **Add to Favorites** to add the port to the Favorites list (see *Favorites*, page 81). If the port is already designated as a Favorite, the button offers to remove the port from your Favorites list. Click **Clear Name** to erase the port's name.

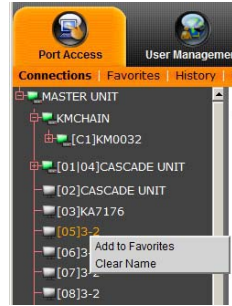

Show

When you click *Show*, at the bottom of the Sidebar, several input methods appear that allow you to control the number and type of ports that display in the Sidebar tree, as well as which ports get scanned when Auto Scan Mode is invoked (see *Auto Scanning*, page 106):

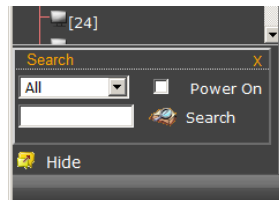
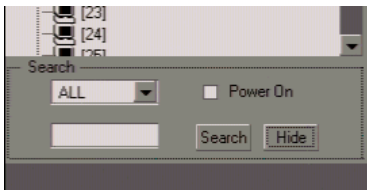

The meanings of the choices are explained in the table, below:

Choices	Explanation
All	This is the default view. With no other filter options selected, all of the ports that are accessible to the user are listed in the Sidebar tree. If any <i>Favorites</i> have been specified (see page 81), you can drop down the list box and select Favorites instead of All. If you select Favorites, only the items you have selected as Favorites display in the tree.
Power On	If you enable <i>Power On</i> (by putting a check in the checkbox) only the ports that have their attached devices powered on display in the tree.
Search	If you key in a search string and click Search , only port names that match the search string display in the tree. Wildcards (? and *) are acceptable, so that more than one port can show up in the list. For example, if you key in Web* , both Web Server 1 and Web Server 2 show up in the list.
Hide	Clicking Hide closes the Show dialog.

Connections

The Connections page displays port status information at the device level, and port connection configuration options at the port level.

Device Level

When a Matrix KVM Switch is selected in the Sidebar, the Connections page main panel displays a list of ports for the device that the user is authorized to access or view.

Console UI

Port Number	Port Name	Status	KVM Adapter	Operation
[KMCHAIN]		-	KMCHAIN	
[01]	KM0032	On	KM0932	
[02]	KM0032	-		Connect
[03]	KA7176	-		Connect
[05]	3-2	-		Connect
[06]	3-2	-		Connect
[07]	3-2	-		Connect
[08]	3-2	-		Connect
[09]	ATEN1-25	-		Connect
[10]	ATEN1-29	-		Connect
[11]	ATEN1-28	-		Connect
[12]	ATEN1-30	-		Connect
[13]	ATEN1-26	-		Connect
[14]	ATEN1-27	-		Connect
[15]	ATEN1-32	-		Connect
[16]	ATEN1-31	-		Connect
[17]	KA7176	-		Connect
[18]	KA7176	On	KA7176	Connect
[19]		-		Connect
[20]		-		Connect
[21]	KA7130-1	-		Connect
[22]		-		Connect
[23]	KA7170-60MB1500	-		Connect

Browser UI

Port Number	Port Name	Status	KVM Adapter	Virtual Media
[01][04]	CASCADE UNIT	On	KM0932	
[02]	CASCADE UNIT	Off		
[03]	KA7176	Off		
[05]	3-2	Off		
[06]	3-2	Off		
[07]	3-2	Off		
[08]	3-2	Off		
[09]	ATEN1-25	Off		
[10]	ATEN1-29	Off		
[11]	ATEN1-28	Off		
[12]	ATEN1-30	Off		
[13]	ATEN1-26	Off		
[14]	ATEN1-27	Off		
[15]	ATEN1-32	Off		
[16]	ATEN1-31	Off		
[17]	KA7176	Off		
[18]	KA7176	On	KA7176	
[19]		Off		
[20]		Off		
[21]	KA7130-1	Off		
[22]		Off		
[23]	KA7170-60MB1500	Off		
[24]		Off		
[25]	ATEN1-22	Off		
[26]	ATEN1-18	Off		
[27]	ATEN1-17	Off		

The column headings and their meanings are described in the table, below:

Heading	Meaning
Port Number	The port's number on the switch.
Port Name	If a name has been assigned to a port it displays here.
Status	The current status of the port – online, or offline: <ul style="list-style-type: none"> ◆ If the port is online, the word <i>On</i> appears. ◆ If the port is offline, a dash (Console UI) or the word <i>Off</i> (Browser UI) appears.
KVM Adapter	The type of KVM Adapter Cable connected to the port. (See <i>KVM Adapter Cables</i> , page 5, for adapter cable models and usage.)
Operation (Console UI only)	Connect means you can access the port by double clicking anywhere on its line entry.
VM (Browser UI only)	Indicates the status of Virtual Media on the server connected to the port. Mapped means that a virtual media device has been mapped from the console module's USB port to the server connected to the port; if virtual media is not active, a dash appears. See <i>Vm Mount</i> , page 80, for mounting details.

Note: The sort order of the information displayed can be changed by clicking the column headings.

Port Level

When a port is selected in the Sidebar tree, the Connections page changes to display the port's attributes and connection options:

Console UI

Port Attributes:

The port attributes are read only, and are for your reference. The attributes are configured on the Port Access *Properties* page (see page 90).

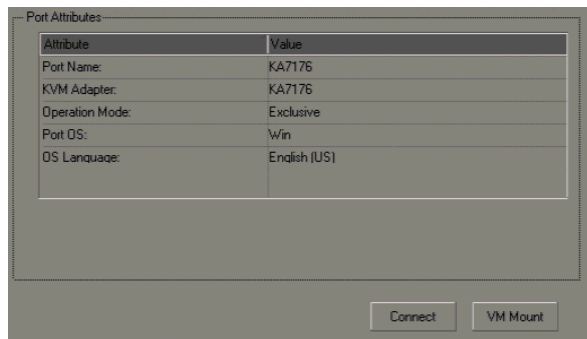

Connect:

Clicking *Connect*, switches you to the server connected to the port.

Vm Mount:

Clicking *VM Mount*, maps a virtual media device connected to the console module's USB port on the server connected the port.

Note: This can only be done with Console Modules and KVM Adapter cables that support virtual media.

Browser UI**Port Attributes:**

The port attributes are read only, and are for your reference. The



attributes are configured on the Port Access *Properties* page (see page 90).

Associated Link

If a PN0108 PON (Power Over the NET™) power outlet port has been associated with this port (see *Association*, page 48), you can control its power status from this page by clicking the socket icon.

Favorites

The *Favorites* page is similar to a bookmarks feature. Ports that you frequently visit can be saved in a list here. Simply open this page and select the port – rather than hunting for it in the Sidebar. In addition, you can limit the ports that get scanned under *Scan Mode*, to just the ones you have selected as Favorites (see *Scan Mode*, page 85).

Console UI

ID	Path	Port Name	Status	KVM Adapter
01	[02]	KM0032	-	
02	[13]	ATEN1-26	-	
03	[15]	ATEN1-32	-	
04	[18]	KA7176	On	KA7176

Browser UI

ID	Path	Port Name	Status	KVM Adapter	Virtual Media
01	[02]	CASCADE UNIT	Off		
02	[13]	ATEN1-26	Off		
03	[15]	ATEN1-32	Off		
04	[18]	KA7176	On	KA7176	

Adding a Favorite

Console GUI: To add a favorite under the Console GUI, first select the port in the Sidebar, then click **Add** (at the bottom of the main panel).

Browser GUI: To add a favorite under the Browser GUI:

Right click on the port in the Sidebar, then click the **Add to Favorites** button that appears.

– Or –

Select the port in the Sidebar, then click **Add**.

Removing a Favorite

To remove a favorite, simply select it in the main panel, then click then click **Delete** (at the bottom of the main panel).

History

The Matrix KVM Switch logs all the events that take place on it. The *History* page displays the information in the log file:

Device	Port No	Port Name	Online	KVM Adapter	Time
KM0932 TOP	9		-		2009-05-27 14:47:25
KM0932 TOP	17		-		2009-06-05 17:11:26
KM0932 TOP	14		-		2009-06-05 17:12:45
KM0932 TOP	19	KA7120-3	-		2009-06-08 10:24:11
KM0932 TOP	32		-		2009-06-08 11:15:18
KM0932 TOP	1	KA7120-3	On	KA7120	2009-06-08 11:31:21

ATEN International Co., Ltd. All rights reserved.

Note: The History page is only available with the Browser UI version.

Preferences

The *Preferences* page allows users to set up their own, individual, working environments. The Matrix KVM Switch stores a separate configuration record for each user profile, and sets up the working configuration according to the *Username* that was keyed into the Login dialog box.

Console UI

The screenshot shows the 'Console UI' preferences window. It features a list of settings on the left and their corresponding controls on the right. The settings include Language, OSD Hotkey, ID Display, ID Duration, Scan Duration, Screen Blanker, Logout Timeout, Broadcast Timeout, View Mode, Scan Mode, Beeper, Hotkey Command, Audio, and password fields. At the bottom, there are 'Save' and 'Restore Defaults' buttons, and a copyright notice for ATEN International Co., Ltd.

Language:	English
OSD Hotkey:	[Scroll Lock] [Scroll Lock]
ID Display:	Port Number + Port Name
ID Duration:	3 sec (0-240) <input type="checkbox"/> Always
Scan Duration:	5 sec (0-240)
Screen Blanker:	0 min (0-30) <input checked="" type="checkbox"/> Disabled
Logout Timeout:	0 min (0-180) <input checked="" type="checkbox"/> Disabled
Broadcast Timeout:	5 sec (0-240) <input type="checkbox"/> Disabled
View Mode:	Accessible
Scan Mode:	Favorites
Beeper:	<input type="checkbox"/> Disabled
Hotkey Command:	<input type="checkbox"/> Disabled
Audio:	<input checked="" type="checkbox"/> Speaker <input checked="" type="checkbox"/> Microphone
Old Password:	<input type="password"/>
New Password:	<input type="password"/>
Confirm Password:	<input type="password"/>

Buttons: Save, Restore Defaults

Copyright: ATEN International Co., Ltd. All rights reserved.

Browser UI

The screenshot shows the 'Browser UI' preferences window. It is similar to the Console UI version but includes a 'Welcome Message' section with 'Enable' and 'Disable' radio buttons, and a 'Username' checkbox. The 'Always On' checkbox is also present for ID Duration. The 'Save' and 'Restore Defaults' buttons are at the bottom, along with the copyright notice.

Language:	English
OSD Hotkey:	[Scroll Lock] [Scroll Lock]
ID Display:	Port Number + Port Name
ID Duration:	3 sec (0-240) <input type="checkbox"/> Always On
Scan Duration:	5 sec (0-240)
Screen Blanker:	1 min (0-30) <input checked="" type="checkbox"/> Disabled
Logout Timeout:	1 min (0-180) <input checked="" type="checkbox"/> Disabled
Broadcast Timeout:	5 sec (0-240) <input type="checkbox"/> Disabled
Welcome Message:	<input type="radio"/> Enable <input checked="" type="radio"/> Disabled
	<input checked="" type="checkbox"/> Username
View Mode:	Accessible
Scan Mode:	Favorites
Beeper:	<input type="checkbox"/> Disabled
Hotkey Command:	<input type="checkbox"/> Disabled
Audio:	<input checked="" type="checkbox"/> Speaker <input checked="" type="checkbox"/> Microphone
Old Password:	<input type="password"/>
New Password:	<input type="password"/>
Confirm Password:	<input type="password"/>

Buttons: Save, Restore Defaults

Copyright: ATEN International Co., Ltd. All rights reserved.

Changing the Preference Settings

Make your settings changes according to the information given in the following table:

Setting	Function
Language	Selects the language that the interface displays in. Drop down the list of available languages to choose the one you want.
Toolbar Hotkey	Selects which Hotkey controls the Toolbar: [Scroll Lock] [Scroll Lock], or [Ctrl] [Ctrl]. Since the Ctrl key combination may conflict with programs running on the local client computers or servers, the default is the Scroll Lock combination.
ID Display	Selects how the Port ID is displayed: the Port Number plus the Port Name (Port Number + Port Name); the Port Number alone (Port Number); or the Port Name alone (port name). The default is Port Number + Port Name.
ID Duration	Determines how long a Port ID displays on the monitor after a port change has taken place. You can choose an amount from 0–255 seconds, or check <i>Always On</i> . Note: A setting of 0 (zero) has the same effect as checking Always On. The default is 3 Seconds.
Scan Duration	Determines how long the focus dwells on each port as it cycles through the selected ports in Scan Mode (see <i>Auto Scanning</i> , page 106). Key in a value from 1–240 seconds. The default is 5 seconds.
Screen Blanker	If there is no input from the console for the amount of time set with this function, the screen is blanked. Key in a value from 0–30 minutes, or check <i>Disabled</i> to disable this function. If you check Disabled, the screen is never blanked. Note: A setting of 0 (zero) has the same effect as checking Disabled. The default is Disabled.
Logout Timeout	If there is no user input for the amount of time set with this function, the user is automatically logged out. A login is necessary before the Matrix KVM Switch can be accessed again. Key in a value from 0–180 minutes, or check <i>Disabled</i> to disable this function. If you check Disabled, users are never automatically logged out, no matter how much time passes. Note: A setting of 0 (zero) has the same effect as checking Disabled. The default is Disabled.
Broadcast Timeout	When <i>Broadcast</i> is Enabled (see page 87), if there is no user input for the amount of time set here, the Broadcast function is automatically ended. Key in a value from 0–240 seconds, or check Disabled to disable this function. If you check Disabled, the broadcast function is never automatically ended, no matter how much idle time passes. Note: A setting of 0 (zero) has the same effect as checking Disabled. The default is Disabled.

Setting	Function
Welcome Message (Browser UI)	<p>If this is enabled, a welcome message appears at the right side of the menu bar. If it is disabled, no welcome message appears. When the function is enabled, if you put a check in the <i>Username</i> checkbox, the user's name appears with the welcome message.</p> <p>The default is Enabled.</p>
View Mode	<p>Selects which ports appear in the Sidebar. Choices are:</p> <p>Accessible - All the ports that the user is permitted to access are listed.</p> <p>Power On - Only the ports that the user is permitted to access and that have their attached computers powered on are listed.</p> <p>The default is Power On.</p>
Scan Mode	<p>Selects which computers will be accessed under Auto Scan Mode (see page 106). Choices are:</p> <p>Favorites - Only the ports that have been selected as <i>Favorites</i> (see page 81), are scanned.</p> <p>Accessible - All the ports that the user is permitted to access are scanned.</p> <p>Power On - Only the ports that the user is permitted to access and that have their attached computers powered on are scanned.</p> <p>The default is Power On.</p>
Beeper	<p>When set to Enabled, the beeper sounds whenever a Port is changed; when activating the Auto Scan function (see page 106); or if only a single power line is connected (or only a single power switch is On).</p> <p>The default is Enabled.</p>
Hotkey Command	<p>Putting a check in the <i>Disabled</i> checkbox, disables the GUI hotkeys in case they conflict with other programs running on the computers.</p>
Audio	<p>Click to put a check in the checkbox in front of Speaker and/or Microphone to enable them.</p> <ul style="list-style-type: none"> ◆ Enabling <i>Speaker</i> allows sound output from the servers connected to the switch's ports to be heard on the speakers connected to the Console and browser connected client computers. ◆ Enabling <i>Microphone</i> allows microphone input from the Console to be sent to the servers connected to the switch's ports.
Changing a Password	<p>To change a user's password:</p> <ol style="list-style-type: none"> 1. Key the old password into the Old Password input box. 2. Key the new password into the New Password input box. 3. Key the new password into the Confirm Password input box.

When you have finished making your settings changes, click **Save**.

Restore Defaults

Clicking Restore Defaults undoes all Preference page changes that have been made to the Matrix KVM Switch, and returns the parameters to their original factory default settings.

Sessions

The *Session* page lets the administrator see at a glance all the users currently logged into the Matrix KVM Switch, and provides information about each of their sessions.

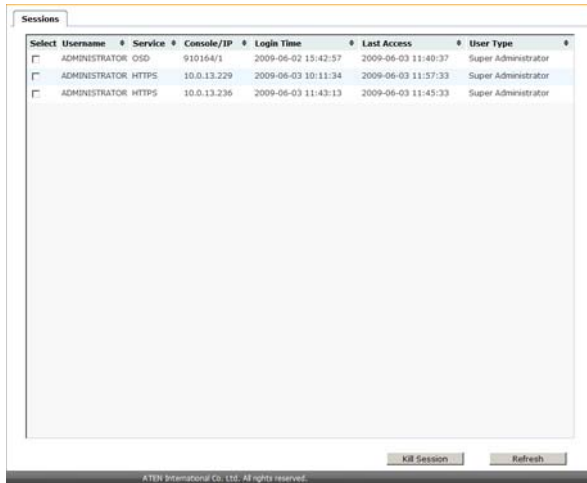

Note: The Sessions page is only available with the Browser UI.

The meanings of the headings at the top of the page are fairly straightforward. The headings that might need further explanation are as follows:

- ◆ The information under the *Service* heading indicates whether the user has logged in via a browser connection (HTTPS), or from a local console.
- ◆ The information under the *Console/IP* heading indicates:
 - ◆ For Console connections: The console's name followed by a slash, and then the console port number on the switch it is connected to. For example: **Taipei/1** (where the console's name is Taipei, and it is connected to Console port 1).
 - ◆ For Browser connections: The IP address of the client computer.

Kill Session

Administrators have the option of forcing user logouts by selecting the user(s) and clicking **Kill Session**. Clicking the **Refresh** button clears any selections you have made (all the checkboxes become unchecked).

Scan

Clicking this menu item starts Scan Mode. See *Auto Scanning*, page 106 for details.

Note: Scan is only available with the Console UI.

Broadcast

When Broadcast is Enabled, commands sent from the console are broadcast to all available computers on the installation.

Note: Broadcast is only available with the Console UI.

This function is particularly useful for operations that need to be performed on multiple computers, such as performing a system wide shutdown, installing or upgrading software, etc.

Broadcast Mode works in conjunction with the *View Mode* function (see *View Mode*, page 85).

View Mode broadens or narrows the focus of which ports appear in the Sidebar. When you Broadcast a command, it only goes to the ports currently listed in the Sidebar.

To enable Broadcast, select the **Enable** radio button, then click **Save**.

- ◆ While Broadcast Mode is in effect, a **[b]** appears before the Port ID Display of the port that currently has the console focus.
- ◆ While Broadcast Mode is in effect, the mouse will not function normally. You must exit Broadcast Mode in order to regain control of the mouse.

To exit Broadcast Mode, invoke the GUI (with the Hotkey); select *Broadcast* on the menu bar; select the *Disable* radio button; then click **Save**.

Access

The *Access* page is used to set user and group access rights on a port-by-port basis.

Console UI

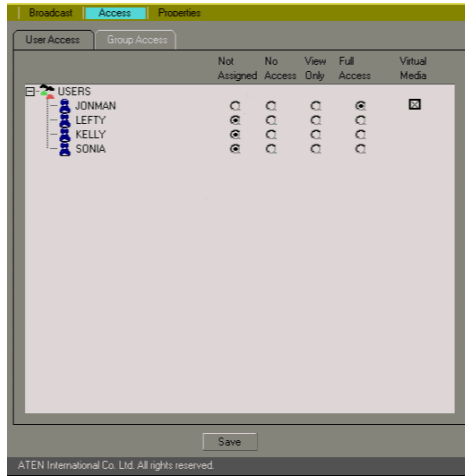

Browser UI

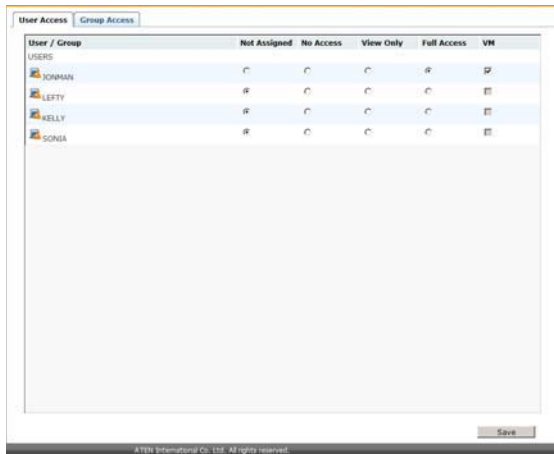

Users and Groups are listed on separate pages – click the appropriate tab at the top of the panel to switch between the pages.

To set a user's access rights for a port, first select the port in the Sidebar tree, then check the appropriate radio buttons in the user's row.

Note: Only powered on ports can be configured.

The meanings of the access categories are given in the table, below:

Category	Meaning
Not Assigned	No permission setting is specifically assigned for the user. If a user belongs to a group that has rights to the device, however, the port will appear in the user's Sidebar tree and the user can access the device according to the rights that belong to the group.
No Access	No access rights - the user has no rights to view or perform any operations on the server connected to the port. The port will not appear in the user's Sidebar. With this setting, even if a user belongs to a group that has rights to the device, the user will still not see the device in the Sidebar, and will not be able to access it.
View Only	The user can only view the screen display of the server connected to the port. The user cannot perform any operations on the server connected to the port.
Full Access	The user can view the screen display of the server connected to the port. The user can also perform operations on the server connected to the port from his keyboard client computer.
Virtual Media (Console UI) VM (Browser UI)	When <i>Full Access</i> is selected, the Virtual Media (VM) category becomes enabled, and a selection checkbox appears. Click to put an X (Console) or checkmark (Browser) to permit the user to mount a virtual media device connected to the console module's USB port on the server connected the port (see <i>Vm Mount</i> , page 80, for more information).

After you have made your access configuration settings, click **Save** (at the bottom of the main panel).

Properties

Configuring Port Properties

To configure a port's properties, bring up the Port Properties configuration page, as follows:

1. Under the *Port Access* tab, select the **Properties** menu item.
2. Click on the port in the Sidebar

– or –

Select the port in the main panel, then click **Modify**.

Console UI

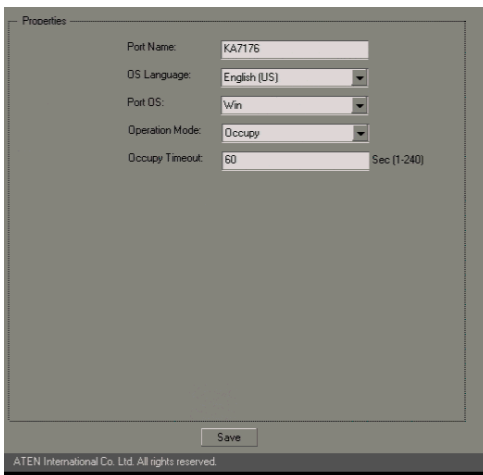

The screenshot shows a 'Properties' dialog box with the following fields:

Port Name:	KA7176
OS Language:	English (US)
Port OS:	Win
Operation Mode:	Occupy
Occupy Timeout:	60 Sec (1-240)

At the bottom of the dialog is a 'Save' button and the text 'ATEN International Co. Ltd. All rights reserved.'

Browser UI

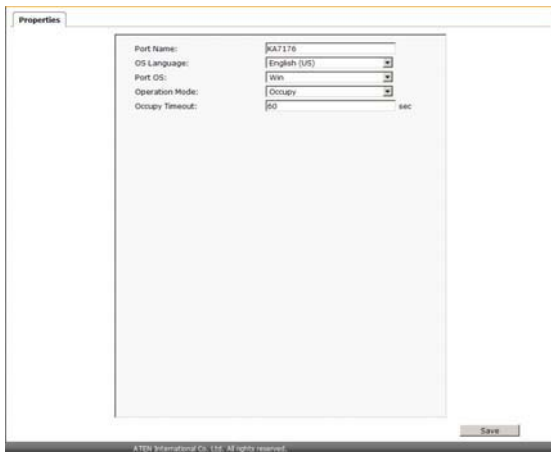

The screenshot shows a 'Properties' dialog box with the following fields:

Port Name:	KA7176
OS Language:	English (US)
Port OS:	Win
Operation Mode:	Occupy
Occupy Timeout:	60 sec

At the bottom of the dialog is a 'Save' button and the text 'ATEN International Co. Ltd. All rights reserved.'

An explanation of the configuration fields is given in the table, below:

Field	Explanation
Port Name	For convenience – especially in large installations with many switches and ports – each switch and each port can be given a name. Key in a name for the port (or change/delete a previous one). The maximum number of characters allowed for a port name is 15. You can use any combination of letters, numbers, and symbols on the typewriter keys of keyboards with PC US English layout.
OS Language	Specifies the OS language being used by the server on the connected port. Drop down the list to see the available choices. The default is English US.
Port OS	Specifies the operating system that the server on the connected port is using. Choices are Win, Mac, and Sun. The default is Win.
Operating Mode	<p>Defines how the port is to be accessed when multiple users have logged on, as follows:</p> <p>Exclusive: The first user to switch to the port has exclusive control over the port. No other users can view the port. The <i>Occupy Timeout</i> function does not apply to ports which have this setting (see <i>Occupy Timeout</i> – below, in this table).</p> <p>Occupy: The first user to switch to the port has control over the port. However, additional users may view the port's video display. If the user who controls the port is inactive for longer than the time set in the <i>Occupy Timeout</i> box, port control is transferred to the next user to move the mouse or strike the keyboard.</p> <p>Share: Users simultaneously share control over the port. Input from the users is placed in a queue and executed chronologically.</p>
Occupy Timeout	<p>This field sets a time threshold for ports whose Access Mode has been set to <i>Occupy</i> (see <i>Operating Mode</i> – above, in this table). If there is no activity from the user occupying the port for the amount of time set here, the user is timed out and the port is released. The first user to send keyboard or mouse input after the port has been released gets to occupy the port.</p> <p>Input a value from 1 to 240 seconds. The default is 3 seconds.</p>

When you have finished making your configuration settings click **Save** to return to the Properties main page.

Restore Defaults

Clicking the Restore Defaults button when in the Properties main page causes the properties for all ports to revert to their default settings.

PON

If a Power over the NET™ (PON) module is connected to your installation clicking the PON menu item starts a Java Applet viewer that brings up its interface – allowing you to remotely power manage servers connected to the Matrix KVM Switch. (See *Association*, page 48.)

- Note:**
1. PON is only available with the Browser UI.
 2. PON support is implemented through the browser via a Java Applet Viewer. Therefore, the latest version of Sun's Java Runtime Environment (JRE) must be installed on the client computer (the one you use to log into the Matrix KVM Switch with).
 3. The PON viewer can only be used in the current browser session. If you log out, the applet will stop. You must download and run the applet again the next time you log in.
-

Once you download and run the Java Applet, the PON's login screen comes up. Refer to the User Manual that came with your PON package for information on PON operation.

Note: Visit our website for the latest information regarding our PON products.

Chapter 9 Log

Overview

The Matrix KVM Switch logs all the events that take place on it. The log stores a maximum of 512 events. When the limit is reached, the oldest events get discarded as new events come in. To view the contents of the log, click the *Log* icon. A screen similar to the one below appears:

Console UI:

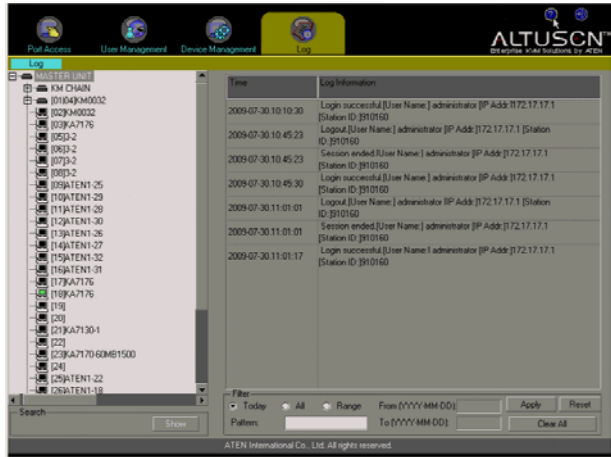

Browser UI:



Console UI

A listing of the events that have been recorded in the log file appear in the main panel: the time of the event is listed in the left column; a description of the event that occurred at that time is listed to the right. To clear the list click **Clear All** (at the bottom right of the *Filter* panel).

Log Filtering

The *Filter* panel at the bottom of the page allows you to filter the log file for events containing specific words or strings:

A description of the items is given in the table, below:

Item	Description
Today	Select this radio button to filter results for records from the current day only.
All	Select this radio button to filter results for all the records in the log file.
Range	Select this radio button to filter results for records for a particular time period, then key in the <i>From</i> and <i>To</i> dates in their respective text input boxes using a YYYY-MM-DD format.
Pattern	Key in the pattern that you are searching for here.
Apply	Click to start the search. The results of the search will appear in the main panel. Note: Only the data in the <i>Log Information</i> column is searched.
Reset	Click to clear all the filter fields and display the complete (pre-filtered) log in the main panel.

Browser UI

Like the Console page, the events that have been recorded in the log file appear in the main panel: the time of the event is listed in the left column; a description of the event that occurred at that time is listed to the right. To clear the list click **Clear All**.

Log Filtering

The browser interface provides a log filtering function similar to the one that the console interface offers. Click **Filter** to bring up the Filter panel:



- ◆ The browser-based filter panel is similar to the console-based one. Refer back to the information given for the console-based filter for operation details.
- ◆ To dismiss this panel, click the Filter button, again.

Export

Export provides a convenient means of auditing the log file. When you click Export, a dialog box comes up that offers the opportunity to open the contents of the log file in Excel (for Windows users), or to save the contents to file in csv format (for Windows and other platforms):

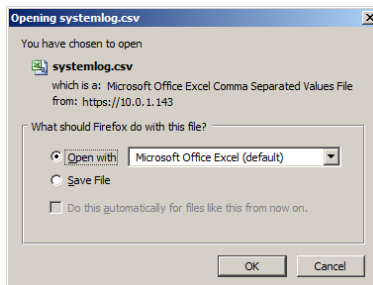

Csv files can be opened in standard spreadsheet programs, such as Excel and Open Office Calc.

This Page Intentionally Left Blank

Chapter 10

Maintenance

Overview

The Maintenance tab offers two menu items: *Backup/Restore*, and *Firmware Upgrade*:

- ◆ Backup/Restore allows super administrators to backup KM0032 / KM0532 / KM0932 system configuration settings to a file, and restore configuration settings from previously saved files.
- ◆ Firmware Upgrade allows super administrators to upgrade firmware for connected Matrix KVM Switches, attached console modules, and KVM adapter cables.

Note: Maintenance is only available from a browser session. The Backup/Restore and Firmware Upgrade operations are not available from a console session.

Backup / Restore

When you click the **Maintenance** tab, the Browser UI opens with the *Backup/Restore* menu page displayed. The page is divided into two main sections: *Backup*, and *Restore*:

The screenshot shows a web interface for Backup / Restore. It has a title bar 'Backup / Restore'. Below it, there are two main sections. The first section is labeled 'Backup' and contains a 'Password:' label followed by a text input field and a 'Backup' button. The second section is labeled 'Restore' and contains a 'Filename:' label with a text input field and a 'Browse...' button, a 'Password:' label with a text input field, and a 'Restore' button.

The operations performed in the backup/restore procedures are described in the table, below:

Procedure	Operation
Backup	Backs up the system configuration – including master station settings, user and group accounts, user profiles, port access rights, and favorites.
Restore	Deletes the current master station settings, user and group accounts, user profiles, port access rights, and favorites; then restores those settings to the values that exist in the previously saved backup file.

Backup

To back up system configuration settings, do the following:

1. (Optional) In the *Backup* panel, provide a password for the backup file. Any combination of characters may be used for the password.

Note: Providing a password is a security feature – if you provide a password, you will need to give the same password in order to restore the configuration settings from this file.

2. Click **Save**.
3. In the dialog box that comes up, click **OK** to save the configuration file (*System.conf*) to a location on your hard disk.

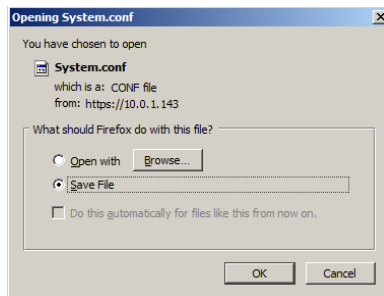

4. Navigate to the directory where you want to save the file and click **Save**.

Restore

To restore system configuration settings, do the following:

1. In the *Restore* panel, click **Browse**.
2. Navigate to the directory where the backup file is located and select it.
3. When you return to the Backup/Restore page enter the password you set when the backup file was created.

Note: If you did not set a password for the file, leave the field blank.

4. Click **Restore**.

When the Restore procedure has finished, a message stating that the Matrix KVM Switch will reboot is sent to all users with active sessions. After a short while the switch reboots. When it comes back up the configuration settings that were restored from the backup file are in effect.

Firmware Upgrade

New firmware versions can be downloaded from our website as they become available. Check the website regularly, to find the latest upgrade packages.

Under Firmware Upgrade the following devices get upgraded simultaneously:

- ◆ The master KVM switch
- ◆ All daisy chained KVM switches
- ◆ All consoles attached to the master switch
- ◆ All KVM adapter cables connected to the master and daisy chained switches.

-
- Note:**
1. For dual root installations, the slave stations do not get upgraded simultaneously – they must be upgraded separately.
 2. Cascaded stations, consoles attached to cascaded stations, and KVM adapter cables connected to cascaded switches do not get upgraded with this function. Each station (including its consoles and KVM adapter cables) must be upgraded on a station-by-station basis.
 3. Before performing the upgrade, you may want to notify users that the system will be going down, and that they should log out of their sessions.
-

To upgrade the firmware do the following:

1. From a computer that is not part of your KVM installation go to our website and download the firmware upgrade package appropriate to your Matrix KVM Switch.
2. Open your browser and log in to the Matrix KVM Switch with a super administrator's account.
3. Click the **Maintenance** tab; select **Firmware Upgrade** on the menu bar. A confirmation dialog box appears:

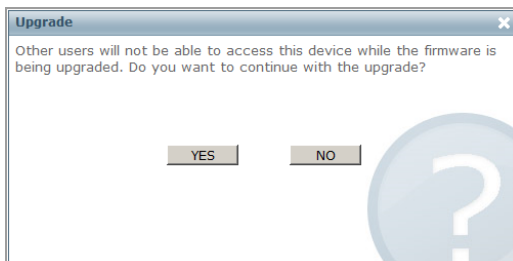

- Click **Yes** to continue. After a short while, the *Firmware Upgrade* page comes up:

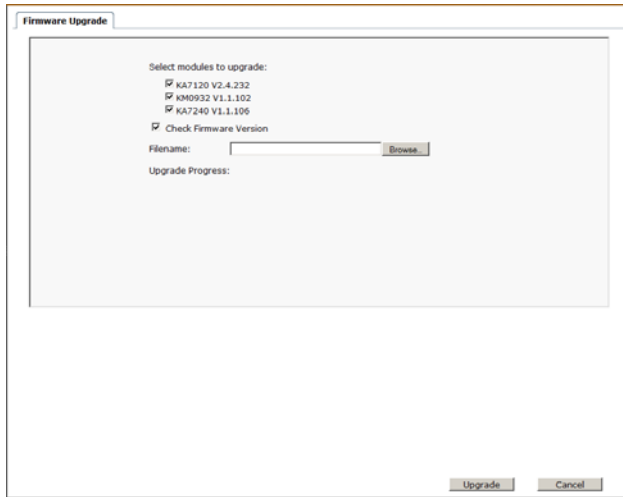

All the stations, consoles and KVM adapters that are capable of being upgraded are listed.

Note: Only online stations and consoles, as well as KVM adapters connected to online devices show up in the list. Offline stations and consoles, as well as adapters connected to offline devices do not get upgraded.

- Make sure there is a check in the checkbox in front of the modules you want to upgrade. Uncheck the modules that you do not want to upgrade.
- Click **Browse**. Navigate to the directory where the firmware upgrade file is located and select it.
- Enable or disable *Check Firmware Version*
 - ◆ If you enabled *Check Firmware Version* the current firmware level is compared with that of the upgrade file. If the current version is equal to or higher than the upgrade version, a popup message appears, to inform you of the situation and stops the upgrade procedure.
 - ◆ If you didn't enable *Check Main Firmware Version*, the upgrade file is installed without checking what its level is.

8. Click **Upgrade** to start the upgrade procedure. As the upgrade proceeds, progress information is shown on the screen. Once the upgrade completes successfully, the switch resets itself.
9. Log in again, and check the firmware version to be sure it is the new one.

Firmware Upgrade Recovery

Should the switch's firmware upgrade procedure fail, and the switch becomes unusable, the following firmware upgrade recovery procedure will resolve the problem:

1. Power off the switch.
2. Press and hold the Reset Switch in (see *Reset Switch*, page 7 for details).
3. While holding the Reset Switch in, power the switch back on.

This causes the switch to use the original factory installed main firmware version. Once the switch is operational, you can try upgrading the main firmware again.

Adapter Cable Firmware Upgrade Recovery

Should the adapter firmware upgrade procedure fail for one of the KVM Adapter Cables and the adapter becomes unusable, the following adapter firmware upgrade recovery procedure will resolve the problem:

1. Unplug the Adapter from the computer it is connected to.
2. Slide its *Firmware Upgrade Recovery Switch* (located next to the Cat 5e connector) to the **RECOVER** position.
3. Plug the Adapter back into the computer.
4. Repeat the Adapter upgrade procedure.
5. After the Adapter has been successfully upgraded, unplug the Adapter from the computer it is connected to; slide the Firmware Upgrade Recovery Switch back to the **NORMAL** position; and plug the Adapter back in.

Chapter 11

Console Port Operation

Overview

After you have successfully logged in (see *Logging In*, page 33), the Matrix KVM Switch comes up with the Port Access tab's *Connections* page displayed.



Note: Port operations can only be performed from the Console UI. The Browser UI is for configuration purposes only.

All the ports that a user is permitted to access are listed in the Sidebar tree at the left of the page. To access a device connected to one of the ports, either double click its icon, or click the port's **Connect** link in the main panel.

Once you switch to a port, its screen displays on your monitor, and your keyboard and mouse input affects the remote system. You can operate the device connected to the port just as if you were connected to it directly.

The Port Toolbar

The switch interface provides a toolbar to help you with port switching operations from within the captured port. To bring up the toolbar, tap the Toolbar Hotkey (Scroll Lock or Ctrl), twice. The toolbar appears at the upper left corner of the screen:



Depending on the settings that were selected for ID Display (see page 83), the Port Number and/or the Port Name display at the right of the toolbar. The meanings of the toolbar icons are given in a table on page 105.

When the toolbar displays, mouse input is confined to the toolbar area and keyboard input has no effect on the computer connected to the port. To carry out operations on the computer, you must close the toolbar.

Recalling the Port Access Page

To break the port connection and recall the Port Access page, do the following:

Click the icon on the toolbar that recalls the Port Access page (see *The Toolbar Icons*, page 105)

– or –

Tap the Toolbar hotkey (Scroll Lock or Ctrl), once.

Closing the Toolbar

To close the toolbar, do the following:











Click the **X** icon on the toolbar

– or –

Recall the Port Access page and select the port again.

The Toolbar Icons

The meanings of the toolbar icons are explained in the table below.

Icon	Purpose
	Click to switch to the station previous to the current one in the Sidebar tree.
	Click to switch to the station that comes after the current one in the Sidebar tree.
	Click to switch to the first port listed in the Sidebar tree.
	Click to switch to the first port previous to the current one listed in the Sidebar tree.
	Click to begin Auto Scan Mode. The Matrix KVM Switch automatically switches among the ports that were selected for Auto Scanning with the Port Select and Show functions (see <i>Show</i> , page 77). This allows you to monitor their activity without having to switch among them manually.
	Click to switch to the port that comes after the current one in the Sidebar tree.
	Click to switch to the last port listed in the Sidebar tree.
	Click to recall the Port Access page.
	Click to toggle the toolbar between transparent and opaque.
	Click to close the toolbar.
	Click to log out of the Matrix KVM Switch session.

Toolbar Hotkey Port Switching

When the toolbar displays, you can use hotkeys to provide KVM focus to a port directly from the keyboard. The Matrix KVM Switch provides the following hotkey features:

- ◆ Auto Scanning
- ◆ Skip Mode Switching
- ◆ Port Number Switching

The hotkeys features are explained in the sections that follow:

-
- Note:** 1. In order for hotkey operations to take place, the toolbar must be visible (see *The Toolbar Icons*, page 105).
2. To use the keys designated as hotkeys (i.e. A, P, etc.) for normal, non-hotkey purposes, you must first close the toolbar.
-

Auto Scanning

The Scan function automatically switches among all the ports that are accessible to the currently logged on user at regular intervals, so that the user can monitor their activity automatically. Users can also limit the number of ports scanned with the *Show* function of the Sidebar Tree. See *Show*, page 77 for details.

The amount of time Auto Scan dwells on each port is set with the *Scan Duration* setting (see *Scan Duration*, page 84), but can be changed on the fly via hotkey (see *Hotkey Summary Table*, page 109).

To start Auto Scanning, with the toolbar showing, tap the **A** key. The Auto Scan function (Auto Scan Mode) cycles through the ports in order - starting from the first port in the Sidebar. An **S** appears in front of the Port ID Display to indicate that the port is being accessed under Auto Scan Mode.

- ◆ While you are in Auto Scan Mode, you can pause the scanning in order to keep the focus on a particular server by pressing **P**. During the time that Auto Scanning is paused, the **S** in front of the Port ID blinks On and Off.
- ◆ *Pausing* when you want to keep the focus on a particular server can be more convenient than exiting Auto Scan Mode because when you *Resume* scanning, you start from where you left off. If, on the other hand, you were to exit and then restart Auto Scan Mode, the scanning would start over from the very first port in the Sidebar tree.
- ◆ To *Resume* Auto Scanning after a pause, press any key except [Esc] or the [Spacebar]. Scanning continues from where it left off.

- While Auto Scan Mode is in effect, ordinary keyboard functions are suspended. You must exit Auto Scan Mode in order to regain normal control of the keyboard. To exit Auto Scan Mode press [Esc] or [Spacebar]. Auto Scanning stops when you exit Auto Scan Mode.

Skip Mode Switching

Skip Mode allows you to switch ports in order to monitor the computers manually. You can dwell on a particular port for as long or as little as you like - as opposed to Auto Scanning, which automatically switches after a fixed interval. The Skip Mode hotkeys are the four Arrow keys. Their operation is explained in the table below:

Arrow	Action
←	Skips from the current port to the port previous to it in the Sidebar tree.
→	Skips from the current port to the port that comes after it in the Sidebar tree.
↑	Skips from the current port to the very first port in the Sidebar tree.
↓	Skips from the current port to the very last port in the Sidebar tree.

Port Number Switching

To hotkey switch to a port using the port number method, do the following:

1. Hold down the **Num Lock** key
2. Press and release the **minus** key
3. Release the **Num Lock** key
 [Num Lock] + [-]
4. Key in the port's port number (for example, 09)
5. Tap [Enter].

Keyboard Hotkey Port Switching

Hotkey port switching is also available when the toolbar is closed. In order to use this function, however, you must first invoke hotkey mode, as follows:

1. Hold down the **Num Lock** key;
2. Press and release the **minus** key;
3. Release the **Num Lock** key:

[Num Lock] + [-];

Note: The Minus key must be released within one half second, otherwise Hotkey invocation is automatically cancelled.

When Hotkey Mode is active:

- ♦ Ordinary keyboard and mouse functions are suspended – only Hotkey compliant keystrokes (described in the sections that follow), can be input.
- ♦ Pressing [**Esc**] exits Hotkey Mode.

Port ID Numbering

Each computer on a KM0032 / KM0532 / KM0932 installation has a unique Port ID that reflects the position it occupies in the overall installation. For example:

- ♦ A computer connected to KVM Port 15 of a first stage KM0532 / KM0932 would have a Port ID of **15**.
- ♦ A computer connected to KVM Port 4 of a switch that is cascaded from KVM Port 15 of a first stage KM0532 / KM0932 would have a Port ID of **15 04**. (Single digit port numbers are padded with a preceding zero.)
- ♦ A computer connected to KVM Port 9 of a switch that occupies Station 7 in a daisy chain would have a Port ID of **C7 09**.

Hotkey Summary Table

The following table summarizes Hotkey operations on the KM0032 / KM0532 / KM0932:

Invocation	Hotkey	Action
[Num Lock] + [-]	[Port ID] [Enter]	Switches access to the computer that corresponds to that Port ID.
	[T] [n] [Enter]	Sets the Auto Scan interval to n seconds - where n is a number from 1 - 255.
	[A]	Invokes Auto Scan Mode. When Auto Scan Mode is in effect, [P] or Left Click pauses Auto Scanning. When Auto Scanning is paused, pressing Any Key or another Left Click resumes Auto Scanning.
	[←]	Invokes Skip Mode and Skips from the current port to the first accessible port previous to it.
	[→]	Invokes Skip Mode and Skips from the current port to the next accessible port.
	[↑]	Invokes Skip Mode and Skips from the current port to the last accessible port of the previous Station.
	[↓]	Invokes Skip Mode and Skips from the current port to the first accessible port of the next Station.
	[B]	Toggles the Beeper On or Off.
	[-]	Toggles operation between the user's computer (connected to the Console Module's Local Computer Port), and the KM0532 / KM0932.

Note: You must press [Esc] to exit Auto Scan and Skip Modes.

This Page Intentionally Left Blank

Chapter 12

RS-232 Port Operation

Overview

RS-232 port operation allows Super Administrators or Administrators to establish a serial terminal login to the KM0532 / KM0932 from their computer's COM port to a Console Module's RS-232 port. This allows a Super Administrator or Administrator to monitor the usage of all the consoles and all the ports from a single access point.

This function is extremely useful in large data centers where the display of all the consoles can be projected onto a wall for easy viewing of all operations, and the entire installation can be monitored on a port-by-port basis.

Preparation

The first step in preparing for RS-232 port operation is, to use the modem cable that came with your Console Module to connect the module's RS-232 port to a COM port on your computer.

Next, set up your serial terminal program (such as HyperTerminal) so that it's serial parameters match those of the Console Module. The Console Module's default parameters are given in the table, below:

Parameter	Value
Bit per second:	9600
Data bits:	8
Parity:	None
Stop bits:	1
Flow control:	None

Note: You can deviate from the default parameters provided that both sides match.

Connecting

Once you establish a connection via your terminal program, the command screen comes up.

1. Press **[Enter]** to bring up the *Username* prompt.
2. Key in your username, then press **[Enter]** to bring up the *Password* prompt.
3. Key in your password, then press **[Enter]** to bring up the command prompt:

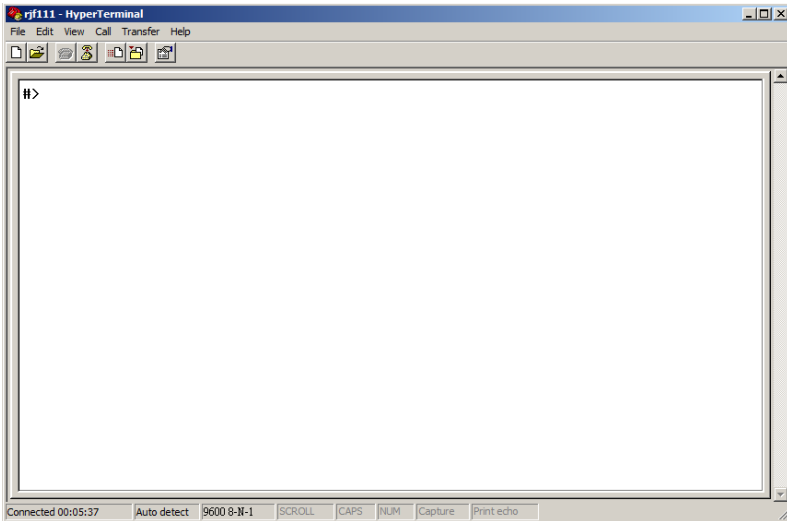

Restrictions

- ◆ Only Super Administrators and Administrators can use this function. It is not available to ordinary users.
- ◆ Super Administrators or Administrators must log in through a serial terminal connection (such as HyperTerminal).
- ◆ A regular login connection (by any user) between the Console Module being used for the RS-232 login and the KM0532 / KM0932 must be established before the RS-232 login attempt.
- ◆ The user profile for the Super Administrator or Administrator logging in over the RS-232 port must exist in the database of the KM0532 / KM0932 that the Console Module is attached to.
- ◆ Access rights:
 - ◆ Super Administrators can access consoles and ports that have been given *Super Administrator*, *Administrator*, and *User* access rights.
 - ◆ Administrators can only access consoles and ports that have been given *Administrator* and *User* rights.
 - ◆ Switching of Console and KVM ports over the RS-232 connection depends on the access rights of the user who is logged into the Console Module via the Console Module port. Only the ports that the user has access rights to are available.

Command Summary

A description of the commands supported with this function is provided in the table below:

Command	Description
SP	This is the Switch Port command. It is followed by a string that specifies which port you want to switch to (see <i>SP</i> , page 115 for details).*
TK	This is the Terminate KVM Session command. It is followed by a string that specifies which port session to terminate (see <i>TK</i> , page 116 for details).*
TS	This is the Terminate Console Session command. It is followed by a string that specifies which console session to terminate (see <i>TS</i> , page 116 for details).
LI	This is the List KVM Ports command. It is followed by the console port number of the console whose KVM ports you wish to list (see <i>LI</i> , page 117 for details).* Note: Following the command with the word <i>ALL</i> , instead of the console port number, lists the KVM ports for all available consoles.
LU	This is the List User Profile command. It is followed by the console port number of the console whose logged in users you wish to see. It displays the profile of the user logged into the specified Console Module, and what the user's status is (Administrator, or User). (See <i>LU</i> , page 117 for details.) Note: 1. Super Administrators' user names and status level are not displayed. <i>NA</i> displays, instead. 2. Following the command with the word <i>ALL</i> , instead of the console port number, lists the user profiles of all users logged into all Console Modules.
Exit	Exits the terminal session.

* Only online ports that are available to the users that are logged into the Console Module(s) are shown with this command.

Examples of the commands are given in the sections that follow.

SP

This command is used to switch the KVM focus to a particular port. The generic format of this command is:

```
SP XX YY ZZ
```

Where:

- ◆ *XX* is a two-digit number that represents the console port number on the KM0532 / KM0932 that the Console Module you wish to access connects to.
- ◆ *YY* represents either a KVM port number on the KM0532 / KM0932 that the Console Module connects to; or the Station Number of a switch daisy chained from the KM0532 / KM0932.
- ◆ *ZZ* is a two-digit number that represents the port on the cascaded or daisy chained switch that you wish to give the focus to.

Example 1 – Single Stage Installation:

To put the KVM focus of the session running on Console Module 5 to KVM Port 18, issue the following command:

```
SP 05 18
```

This command switches the KVM focus of the session running on Console Port 5 from the port it is currently on to KVM Port 18.

After this command is issued, the display of the server connected to KVM Port 18 appears on Console 5's monitor, and Console 5's keyboard and mouse input goes to the server connected to KVM Port 18.

Example 2 – Two Level Cascaded Installation:

```
SP 02 03 08
```

This command switches the KVM focus of the session running on Console Port 2 from the port it is currently on to KVM Port 8 of the second level switch cascaded from KVM Port 3 of the first stage KM0532 / KM0932.

After this command is issued, the display of the server connected to KVM Port 8 of the switch cascaded from KVM Port 3 of the first stage KM0532 / KM0932 appears on Console 2's monitor, and Console 2's keyboard and mouse input goes to the server connected to KVM Port 08 of the switch cascaded from the first stage KM0532 / KM0932's KVM Port 3.

Example 3 – Daisy Chained Installation:

SP 08 C3 12

This command switches the KVM focus of the session running on Console Port 8 from the port it is currently on to KVM Port 12 of a switch that occupies Station 3 in a daisy chain.

After this command is issued, the display of the server connected to KVM Port 12 of the switch that occupies Station 3 in a daisy chain that links back to the top level KM0532 / KM0932, appears on Console 8's monitor, and Console 8's keyboard and mouse input goes to the server connected to KVM Port 12 of the Station 3 switch.

TK

This command is used to terminate a KVM Port session, and takes the following form:

TK XX

Where XX represents the Console Port number of the Console Module that the KVM Port session you want to terminate is running on.

For example, **TK 08** terminates the KVM session running on the Console Module connected to Console Port 8. Once the session terminates, the KM0532 / KM0932 GUI displays on the Console Module.

TS

This command is used to terminate a Console log in session, and takes the following form:

TS XX

Where XX represents the Console Port number of the Console Module whose session you want to terminate.

For example, **TS 08** terminates the log in session of the Console Module connected to Console Port 8. Once the session terminates, the log in screen displays on the Console Module.

LI

This command is used to list the KVM ports that are available on a particular Console Module. The command takes two forms:

```
LI XX
LI ALL
```

Where:

- ◆ *XX* is a two-digit number that represents the console port number on the KM0532 / KM0932 that the Console Module you wish to access connects to.

For example, **LI 04** lists all the available KVM ports that are accessed via the Console Module connected to console module port 4 of the KM0532 / KM0932.

- ◆ *ALL* causes all the available ports on all available Console Modules to be listed.

LU

This command is used to list the user profiles of the users that have logged into the KM0532 / KM0932 installation via the Console Modules. that are available on a particular Console Module. The command takes two forms:

```
LU XX
LU ALL
```

Where:

- ◆ *XX* is a two-digit number that represents the console port number on the KM0532 / KM0932 of the Console Module whose logged in user you wish to list.

For example, **LU 02** lists the user profile of the user who is logged into the Console Module connected to console module port 2 of the KM0532 / KM0932.

- ◆ *ALL* causes the user profiles of all the logged in users on all available Console Modules to be listed.

This Page Intentionally Left Blank

Safety Instructions

General

- ◆ Read all of these instructions. Save them for future reference.
- ◆ Follow all warnings and instructions marked on the device.
- ◆ Do not place the device on any unstable surface (cart, stand, table, etc.). If the device falls, serious damage will result.
- ◆ Do not use the device near water.
- ◆ Do not place the device near, or over, radiators or heat registers.
- ◆ The device cabinet is provided with slots and openings to allow for adequate ventilation. To ensure reliable operation, and to protect against overheating, these openings must never be blocked or covered.
- ◆ The device should never be placed on a soft surface (bed, sofa, rug, etc.) as this will block its ventilation openings. Likewise, the device should not be placed in a built in enclosure unless adequate ventilation has been provided.
- ◆ Never spill liquid of any kind on the device.
- ◆ Unplug the device from the wall outlet before cleaning. Do not use liquid or aerosol cleaners. Use a damp cloth for cleaning.
- ◆ The device should be operated from the type of power source indicated on the marking label. If you are not sure of the type of power available, consult your dealer or local power company.
- ◆ The device is designed for IT power distribution systems with 230V phase-to-phase voltage.
- ◆ To prevent damage to your installation it is important that all devices are properly grounded.
- ◆ The device is equipped with a 3-wire grounding type plug. This is a safety feature. If you are unable to insert the plug into the outlet, contact your electrician to replace your obsolete outlet. Do not attempt to defeat the purpose of the grounding-type plug. Always follow your local/national wiring codes.
- ◆ Do not allow anything to rest on the power cord or cables. Route the power cord and cables so that they cannot be stepped on or tripped over.

- ◆ If an extension cord is used with this device make sure that the total of the ampere ratings of all products used on this cord does not exceed the extension cord ampere rating. Make sure that the total of all products plugged into the wall outlet does not exceed 15 amperes.
- ◆ To help protect your system from sudden, transient increases and decreases in electrical power, use a surge suppressor, line conditioner, or uninterruptible power supply (UPS).
- ◆ Position system cables and power cables carefully; Be sure that nothing rests on any cables.
- ◆ Never push objects of any kind into or through cabinet slots. They may touch dangerous voltage points or short out parts resulting in a risk of fire or electrical shock.
- ◆ Do not attempt to service the device yourself. Refer all servicing to qualified service personnel.
- ◆ If the following conditions occur, unplug the device from the wall outlet and bring it to qualified service personnel for repair.
 - ◆ The power cord or plug has become damaged or frayed.
 - ◆ Liquid has been spilled into the device.
 - ◆ The device has been exposed to rain or water.
 - ◆ The device has been dropped, or the cabinet has been damaged.
 - ◆ The device exhibits a distinct change in performance, indicating a need for service.
 - ◆ The device does not operate normally when the operating instructions are followed.
- ◆ Only adjust those controls that are covered in the operating instructions. Improper adjustment of other controls may result in damage that will require extensive work by a qualified technician to repair.
- ◆ Do not connect the RJ-11 connector marked “UPGRADE” to a public telecommunication network.

Rack Mounting

- ◆ Before working on the rack, make sure that the stabilizers are secured to the rack, extended to the floor, and that the full weight of the rack rests on the floor. Install front and side stabilizers on a single rack or front stabilizers for joined multiple racks before working on the rack.
- ◆ Always load the rack from the bottom up, and load the heaviest item in the rack first.
- ◆ Make sure that the rack is level and stable before extending a device from the rack.
- ◆ Use caution when pressing the device rail release latches and sliding a device into or out of a rack; the slide rails can pinch your fingers.
- ◆ After a device is inserted into the rack, carefully extend the rail into a locking position, and then slide the device into the rack.
- ◆ Do not overload the AC supply branch circuit that provides power to the rack. The total rack load should not exceed 80 percent of the branch circuit rating.
- ◆ Make sure that all equipment used on the rack – including power strips and other electrical connectors – is properly grounded.
- ◆ Ensure that proper airflow is provided to devices in the rack.
- ◆ Ensure that the operating ambient temperature of the rack environment does not exceed the maximum ambient temperature specified for the equipment by the manufacturer
- ◆ Do not step on or stand on any device when servicing other devices in a rack.

Technical Support

Technical support is available both by email and online (with a browser over the web):

International

Email Support		support@aten.com
Online Support	Technical Support	http://support.aten.com
	Troubleshooting Documentation Software Updates	http://www.aten.com
Telephone Support		886-2-8692-6959

North America

Email Support		ATEN TECH	support@aten-usa.com
		ATEN NJ	sales@aten.com
Online Support	Technical Support	ATEN TECH	http://www.aten-usa.com/support
		ATEN NJ	http://support.aten.com
	Troubleshooting Documentation Software Updates	ATEN TECH	http://www.aten-usa.com
		ATEN NJ	http://www.aten.com
Telephone Support		ATEN TECH	1-888-999-ATEN
		ATEN NJ	1-732-356-1703

United Kingdom

Email Support	support@aten.co.uk
Telephone Support	44-8-4481-58923

When you contact us, please have the following information ready beforehand:

- ◆ Product model number, serial number, and date of purchase.
- ◆ Your computer configuration, including operating system, revision level, expansion cards, and software.
- ◆ Any error messages displayed at the time the error occurred.
- ◆ The sequence of operations that led up to the error.
- ◆ Any other information you feel may be of help.

Trusted Certificates

Overview

When you try to log in to the device from your browser, a Security Alert message appears to inform you that the device's certificate is not trusted, and asks if you want to proceed.



The certificate can be trusted, but the alert is triggered because the certificate's name is not found on the Microsoft list of Trusted Authorities. You can ignore the warning and click **Yes** to go on.

IP Address Determination

If you are an administrator logging in for the first time, you need to access the KM0032 / KM0532 / KM0932 in order to give it an IP address that users can connect to. There are three methods to choose from. In each case, your computer must be on the same network segment as the KM0032 / KM0532 / KM0932. After you have connected and logged in you can give the KM0032 / KM0532 / KM0932 its fixed network address. (See *Network*, page 44.)

The Local Console

The easiest way to assign an IP address is from the local console. Refer to *First Time Setup*, page 27, for details on the procedure involved.

IP Installer

For computers running Windows, an IP address can be assigned with the *IP Installer* utility. The utility can be obtained from the *Download* area of our web site. Look under *Driver/SW*, and the model of your switch. After downloading the utility to your computer, do the following:

1. Unzip the contents of *IPInstaller.zip* to a directory on your hard drive.
2. Go to the directory that you unzipped the IPInstaller program to and run *IPInstaller.exe*. A dialog box similar to the one below appears:

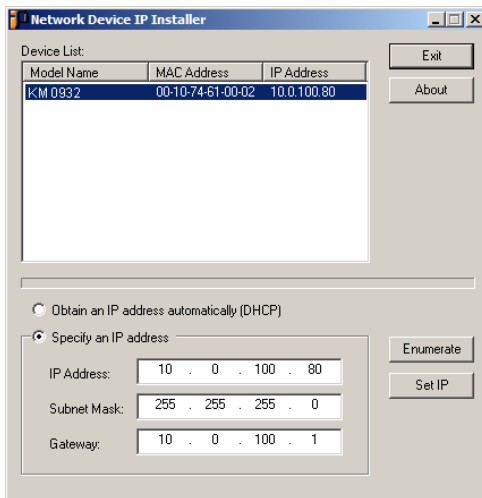

-
3. Select the KM0032 / KM0532 / KM0932 in the *Device List*.

Note: 1. The computer that you run this program from must be on the same network segment as the KM0032 / KM0532 / KM0932 you want to configure.

2. If the list is empty, or your device doesn't appear, click **Enumerate** to refresh the Device List.

3. If there is more than one device in the list, use the MAC address to pick the one you want. The KM0032 / KM0532 / KM0932's MAC address is located on its bottom panel.

4. Select either *Obtain an IP address automatically (DHCP)*, or *Specify an IP address*. If you chose the latter, fill the IP Address, Subnet Mask, and Gateway fields with the information appropriate to your network.
5. Click **Set IP**.
6. After the IP address shows up in the Device List, click **Exit**.

Browser

1. Set your computer's IP address to 192.168.0.XXX
Where XXX represents any number or numbers except 60. (192.168.0.60 is the default address of the KM0032 / KM0532 / KM0932.)
2. Specify the switch's default IP address (192.168.0.60) in your browser, and you will be able to connect.
3. Assign a fixed IP address for the KM0032 / KM0532 / KM0932 that is suitable for the network segment that it resides on.
4. After you log out, reset your computer's IP address to its original value.

Troubleshooting

Overview

Operation problems can be due to a variety of causes. The first step in solving them is to make sure that all cables are securely attached and seated completely in their sockets.

In addition, updating the product's firmware may solve problems that have been discovered and resolved since the prior version was released. If your product is not running the latest firmware version, we strongly recommend that you upgrade. See *Firmware Upgrade*, page 100, for upgrade details.

General

Problem	Solution
I can't use the KA9222 or KA9272 Console Modules with the KM0032 / KM0532 / KM0932.	The KM0032 / KM0532 / KM0932 does not support these two console modules. Instead, use the KA7230, and KA7240 Console Modules with the KM0032 / KM0532 / KM0932.
The KVM console monitor does not display and there is no response to keyboard and mouse input.	<ol style="list-style-type: none"> 1. Verify that all cables are securely connected and in good condition, including those of the console modules, KVM adapter cables, and Cat 5e cable. 2. Upgrade the firmware for the KVM adapter cables.
There are display problems on the monitor connected to the Console Module.	<ol style="list-style-type: none"> 1. Make sure that the console monitor is properly grounded. 2. Use the grounding terminal on the Console Module to properly ground the Console Module.
I can't use the KA7230 and KA7240 Console Modules to login to the KM0032 / KM0532 / KM0932.	<ol style="list-style-type: none"> 1. Verify that the username and password are correct. If after verifying that the username and password are correct you still cannot login, then follow Step 2. 2. Upgrade the firmware version of the console modules.
I can't use an Ethernet hub to connect the console modules and KVM adapter cables to the KM0032 / KM0532 / KM0932.	Although Cat 5e cable is used to connect the console modules and KVM adapter cables to the KM0032 / KM0532 / KM0932, it does not support the Ethernet protocol; thus, you cannot use an Ethernet hub to connect them.
The password for the default super administrator account needs to be reset.	See <i>Restoring Factory Default Settings</i> , page 135
I upgrading the firmware, but some of the modules were not upgraded successfully.	See <i>Firmware Upgrade</i> , page 100.

Problem	Solution
The firmware upgrade process was prematurely aborted and now some of the modules are inoperable.	See <i>Firmware Upgrade Recovery</i> , page 102.
I can't upgrade the firmware version.	Make sure that you have selected the correct firmware upgrade package and try again. When upgrading the firmware through the KM0832 Administrator Utility, use a firmware upgrade package with an FW extension. When the system is unavailable due to a system failure, use a firmware upgrade package with an EXE extension to reinstall the firmware. (See <i>Firmware Upgrade</i> , page 100.)
I can't access the KM0032 / KM0532 / KM0932.	<ol style="list-style-type: none"> 1. Perform a system reset (see <i>Reset Switch</i>, page 7). 2. Reinstall the firmware. (See <i>Firmware Upgrade</i>, page 100.)
When I login, the browser generates a <i>CA Root certificate is not trusted</i> , or a <i>Certificate Error</i> response.	The certificate can be trusted. See <i>Supported KVM Switches</i> , page 129, for details.
Some characters I enter from the keyboard do not display correctly.	<p>Change the keyboard layout setting for the port to match the layout of the keyboard that you are using.</p> <p>To change the keyboard layout setting:</p> <ol style="list-style-type: none"> 1. Open the Port Management Webpage for the port you are having the problem with. 2. In the Keyboard Layout field, select the layout of the keyboard you want to use. 3. Click Save. 4. If the computer attached to the port is a Sun server or iMac, or if changing the keyboard layout setting doesn't immediately resolve the problem, reboot the computer. After rebooting, the characters you enter from the keyboard should display properly.
I can't use the special keys on my Apple (Sun) keyboard to control Mac (Sun) computers.	<p>Change the keyboard setting for the port to match the keyboard that you are using.</p> <p>To change the keyboard setting:</p> <ol style="list-style-type: none"> 1. Open the Port Management Webpage for the port you are having the problem with. 2. In the Keyboard field, select the keyboard you want to use. 3. Click Save. 4. Reboot the computer attached to the port. After rebooting, you should be able to use the special keys on your keyboard to control the computer.

Sun Systems

Problem	Solution
<p>Video display problems with HDB-15 interface systems (e.g. Sun Blade 1000 servers).</p>	<p>The display resolution should be set to 1024 x 768 @ 60Hz.</p> <p>Under Text Mode:</p> <ol style="list-style-type: none"> 1. Enter the <code>ok</code> prompt (see below) and issue the following firmware commands: <pre>setenv output-device screen:r1024x768x60 reset-all</pre> <p>Under XWindow:</p> <ol style="list-style-type: none"> 1. Open a console and issue the following command: <pre>m64config -res 1024x768x60</pre> <ol style="list-style-type: none"> 2. Log out. 3. Log in.
<p>Video display problems with 13W3 interface systems (e.g. Sun Ultra servers).*</p>	<p>The display resolution should be set to 1024 x 768 @ 60Hz.</p> <p>Under Text Mode:</p> <ol style="list-style-type: none"> 1. Enter the <code>ok</code> prompt (see below) and issue the following firmware commands: <pre>setenv output-device screen:r1024x768x60 reset-all</pre> <p>Under XWindow:</p> <ol style="list-style-type: none"> 1. Open a console and issue the following command: <pre>ffbconfig -res 1024x768x60</pre> <ol style="list-style-type: none"> 2. Log out. 3. Log in.
<p>I am using a PC keyboard to control a Sun Solaris server and want to use Stop-A keys to enter the <code>ok</code> prompt.</p>	<p>Do the following:</p> <ol style="list-style-type: none"> 1. Press and release [Ctrl] 2. Press and hold down [T] 3. Press [A]. <p>Note: Before entering the <code>ok</code> prompt, consult the server's documentation for any precautionary steps that you should take.</p>

* These solutions work for most common Sun VGA cards. If these procedures fail to resolve the problem, consult the manual for the Sun VGA card.

Supported KVM Switches

The table below lists KVM switches that are compatible with the KM0032 / KM0532 / KM0932 and the type of expansion that they use. (KVM switches listed below are sold separately. Contact your dealer for details.)

Expansion Type	Brand	Model	Name
Cascade	ALTUSEN	KM0532	5 Console 32 Port Matrix KVM Switch
Cascade	ALTUSEN	KM0932	9 Console 32 Port Matrix KVM Switch
Daisy chain	ALTUSEN	KM0032	32 Port Matrix KVM Switch
Cascade	ALTUSEN	KH1508	8 port PS/2 High Density KVM Switch
Cascade	ALTUSEN	KH1516	16 port PS/2 High Density KVM Switch

Note: Refer to our website for the most up-to-date information regarding supported KVM switches.

Keep in mind the following limitations when installing more than one KVM switch. Where distances are mentioned, they refer to the cumulative length of all cables used to connect the devices.

- ◆ The maximum distance from any console module to the lowest level KVM switch (or Matrix Plus KVM adapter cable in a cascade) cannot exceed 300 meters.
- ◆ The maximum distance between any two KVM switches in the daisy chain cannot exceed 10 meters.

The maximum distance between the first and last KVM switches in the daisy chain cannot exceed 50 meters.

Additional Connection Diagrams

Console Modules

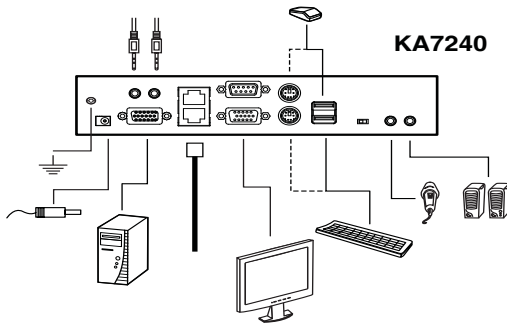
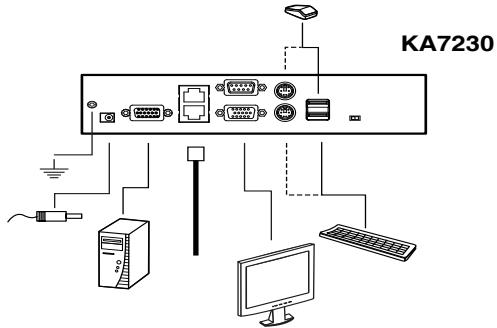

KVM Adapter Cables

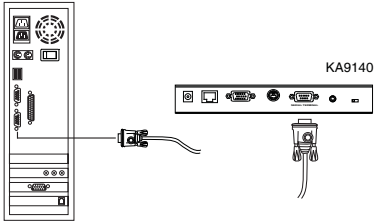
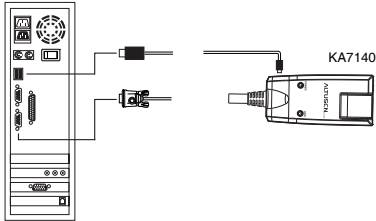
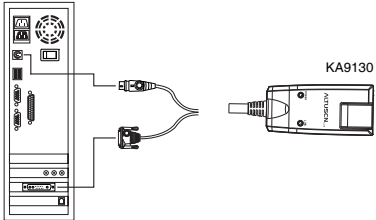
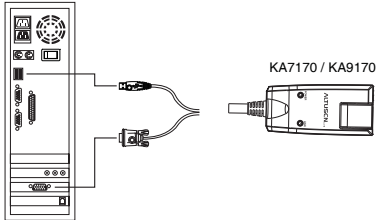
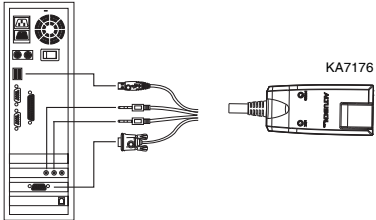
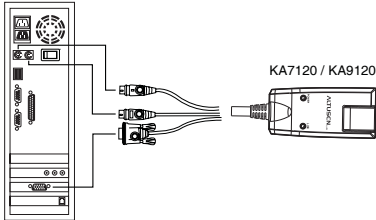

PON Setup

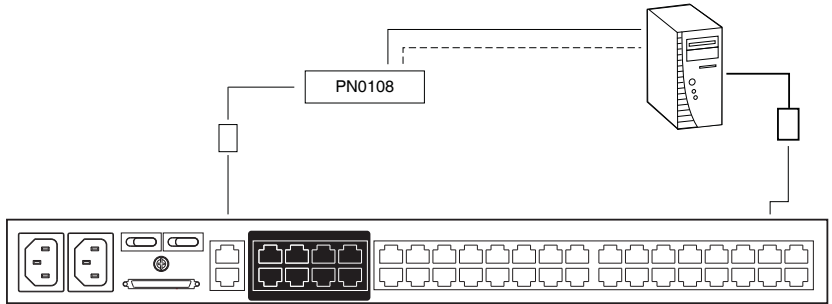

KM0532 / KM0932 Specifications

Function		KM0532	KM0932
Computer Connections	Direct	32	
	Max	8,000	
Console Connections		5	9
Port Selection		GUI, Hotkeys	
Connectors	Console Port	5 x RJ-45 Female	9 x RJ-45 Female
	KVM Port	32 x RJ-45 Female	
	Daisy chain	1 x VHDCI 68 Female (Black)	
	LAN	1 x RJ-45 Female	
	PON	1 x RJ-45 Female (Black)	
	Power	2 x 3-prong AC Socket	
Switches	Reset	1 x Semi-recessed Pushbutton	
	Power	2 x Rocker	
	F/W Upgrade	1 x Slide	
LEDs	Console Port (On Line)	5 (Green)	9 (Green)
	KVM Port (On Line / Selected)	32 Dual-colored (Green / Red)	
	Power	1 (Blue)	
I/P Rating		100–240V AC, 50/60 Hz; 1A	
Power Consumption		120V/50W; 230V/51W	
Emulation	Keyboard/Mouse	PS/2; USB; Serial	
Scan Interval		1–240 Seconds	
Video		1280x1024@60Hz max. 300m;	
Environment	Operating Temperature	0–50° C	
	Storage Temperature	-20–60° C	
	Humidity	0–80% RH, Noncondensing	
Physical Properties	Housing	Metal	
	Weight	6.07 kg	6.08 kg
	Dimensions (L x W x H)	43.36 x 41.09 x 4.40 cm	

KM0032 Specifications

Function		KM0032
Computer Connections	Direct	32
	Max	8,000
Port Selection		via daisy chain
Connectors	KVM Port	32 x RJ-45 Female
	Daisy chain	2 x VHDCI 68 Female (Black)
	F/W Recovery	1 x RJ-45 Female
	PON	1 x RJ-45 Female (Black)
	Power	2 x 3-prong AC Socket
Switches	Reset	1 x Semi-recessed Pushbutton
	Power	2 x Rocker
	F/W Upgrade	1 x Slide
LEDs	KVM Port (On Line / Selected)	32 Dual-colored (Green / Red)
	Station ID	1 x 7-Segment Display (Orange)
	Power	1 (Blue)
I/P Rating		100–240V AC, 50/60 Hz; 1A
Power Consumption		120V/45W; 230V/46 W
Emulation	Keyboard/Mouse	PS/2; USB; Serial
Scan Interval		1–240 Seconds
Video		1280x1024@60Hz max. 300m;
Environment	Operating Temperature	0–50° C
	Storage Temperature	-20–60° C
	Humidity	0–80% RH, Noncondensing
Physical Properties	Housing	Metal
	Weight	6.06 kg
	Dimensions (L x W x H)	43.36 x 41.09 x 4.40 cm

Factory Default Settings

The factory default settings are as follows (in alphabetical order):

Setting	Default
Accessible Ports	<ul style="list-style-type: none"> ◆ Super Administrators – Full for all ports ◆ All other users – None for all ports.
Beeper	On (Activated)
Date & Time	Synchronize with my computer
Daylight Savings Time	Enabled
Default Gateway	192.168.0.254
DHCP Enabled	No (Disabled)
Hotkey Command Mode	On (Enabled)
HTTP Port	80
HTTPS Port	443
Interface Language	English
IP Address	192.168.0.10
Lockout Period	3 minutes
Logout Timeout	0 (Disabled)
Maximum Login Failures	5
Occupy Timeout	60 seconds
Port Access	None (Super Administrators and Administrators have full access)
Port ID Display Duration	User Defined (3 seconds)
Port ID Display Mode	The Port Number plus the Port Name
Port ID Display Position	Upper Left Corner
Port Language	U.S. English
Port Operating System	Windows (PC compatible)
Scan Duration	5 seconds
Scan Mode	Accessible + Powered
Screen Blanker	0 (Disabled)
SMTP Server Mail Notification	No (Disabled)
Subnet Mask	255.255.255.0
Toolbar Hotkey	[Scroll Lock] [Scroll Lock]
View Mode	Accessible + Powered

Restoring Factory Default Settings

You can restore the factory default settings and the default login settings for the Matrix KVM Switch.

Note: When restoring the default login settings, all super administrator, administrator, user, and group accounts are deleted.

To restore the factory default settings (see page 134), or the default login settings, do the following:

1. Power off the switch and remove its housing.
 - ◆ To restore the factory default settings, use a jumper cap to short the mainboard jumper labeled **J4**.
 - ◆ To restore the default login settings, use a jumper cap to short the mainboard jumper labeled **J3**.

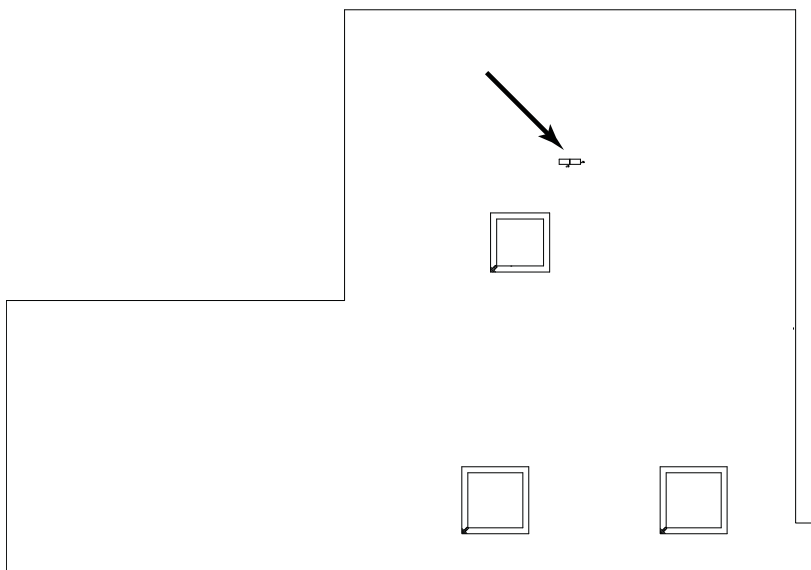

2. Power on the switch.
3. When a message appears on the console screen informing you that the factory default settings have been restored (or the default Username and Password has been restored), power off the switch.
4. Remove the jumper cap from the jumper.
5. Close the housing and start the switch.

KA7140 Pin Assignments

Pin assignments for the KA7140 Adapter are given in the table, below:

Pin	Assignment
1	DCD
2	RXD
3	TXD
4	DTR
5	GND
6	DSR
7	RTS
8	CTS
9	N/A

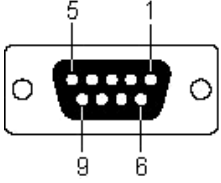

DB9 Female

About SPHD Connectors



This product uses SPHD connectors for its KVM and/or Console ports. We have specifically modified the shape of these connectors so that only KVM cables that we have designed to work with this product can be connected.

Limited Warranty

ALTUSEN warrants this product against defects in material or workmanship for a period of one (1) year from the date of purchase. If this product proves to be defective, contact ALTUSEN's support department for repair or replacement of your unit. ALTUSEN will not issue a refund. Return requests can not be processed without the original proof of purchase.

When returning the product, you must ship the product in its original packaging or packaging that gives an equal degree of protection. Include your proof of purchase in the packaging and the RMA number clearly marked on the outside of the package.

This warranty becomes invalid if the factory-supplied serial number has been removed or altered on the product.

This warranty does not cover cosmetic damage or damage due to acts of God, accident, misuse, abuse, negligence or modification of any part of the product. This warranty does not cover damage due to improper operation or maintenance, connection to improper equipment, or attempted repair by anyone other than ALTUSEN. This warranty does not cover products sold AS IS or WITH FAULTS.

IN NO EVENT SHALL ALTUSEN'S LIABILITY EXCEED THE PRICE PAID FOR THE PRODUCT. FURTHER, ALTUSEN SHALL NOT BE RESPONSIBLE FOR DIRECT, INDIRECT, SPECIAL, INCIDENTAL OR CONSEQUENTIAL DAMAGES RESULTING FROM THE USE OF THE PRODUCT, ITS ACCOMPANYING SOFTWARE, OR ITS DOCUMENTATION. ALTUSEN SHALL NOT IN ANY WAY BE RESPONSIBLE FOR, WITHOUT LIMITATION, LOSS OF DATA, LOSS OF PROFITS, DOWNTIME, GOODWILL, DAMAGE OR REPLACEMENT OF EQUIPMENT OR PROPERTY, AND ANY EXPENSES FROM RECOVERY, PROGRAMMING, AND REPRODUCTION OF ANY PROGRAM OR DATA.

ALTUSEN makes no warranty or representation, expressed, implied, or statutory with respect to its products, contents or use of this documentation and all accompanying software, and specifically disclaims its quality, performance, merchantability, or fitness for any particular purpose.

ALTUSEN reserves the right to revise or update its product, software or documentation without obligation to notify any individual or entity of such revisions, or update.

For details about extended warranties, please contact one of our dedicated value added resellers.

This Page Intentionally Left Blank

Index

A

- Access, 88
- Accounts, 57
 - Adding users, 58
 - Deleting, 61
 - Modifying, 61
- Adding users, 58
- Additional connection diagrams, 130
- ANMS, 46
- Association, 48
- Auto Scanning, 106
 - Scan Interval, 106

B

- Backup / Restore, 97
- Browser UI Main Page, 38

C

- Cables, 5
- Cascading, 21
- Components, 6
- Connection diagrams
 - Console modules, 130
 - KVM Adapter cables, 131
- Connections page, 78
- Console modules, 4
 - connection diagrams, 130
- Console Port Operation, 103
- Console UI Keyboard Navigation, 37
- Creating groups, 62

D

- Daisy chaining, 25
- Date/Time, 52
- Deleting groups, 64

- Deleting user accounts, 61
- Device Assignment, 72
- Device Management, 41
 - ANMS, 46
 - Date/Time, 52
 - General, 42
 - Network, 44
 - System, 55
- Device Permissions
 - assigning, 72, 74
- DNS Server, 45
- Dual Root, 43

E

- Export
 - log file, 95

F

- Factory default settings, 134
 - restoring, 135
- Favorites page, 81
- Firmware upgrade recovery, 102
- Front view
 - KM0032, 8
 - KM0532/KM0932, 6

G

- Grounding, 17
- Groups, 62
 - assigning users, 65, 68
 - creating, 62
 - deleting, 64
 - Modifying, 64
 - removing users, 66, 70

H

- History page, 82

- Hotkey
 - Summary Table, 109
- Hotkey Mode
 - exiting, 108
- Hotkey Port Switching, 108

I

- Installation
 - cascading, 21
 - daisy chaining, 25
 - multilevel, 20
 - overview, 11
 - single level, 18
- Invalid login, 33
- IP
 - Address
 - determination, 124
 - IP Address, 45
 - IP address, default, 134
 - IP Installer, 47, 124

K

- KA7140 Pin Assignments, 136
- Keyboard navigation
 - Console UI, 37
- KM0032, 8
 - front view, 8
 - rear view, 10
- KM0532/KM0932
 - front view, 6
 - rear view, 9
- KVM Adapter Cables, 5
- KVM adapter cables
 - connection diagrams, 131

L

- Log
 - Browser UI, 95
 - Console UI, 94

- Log File, 93
- Log file
 - export, 95
- Log filtering
 - Browser, 95
 - Console, 94
- Logging in
 - Browser, 34
 - Console, 33
- Login
 - Invalid login, 33

M

- MAC Address, 42
- Maintenance, 97
- Modifying groups, 64
- Modifying user accounts, 61

N

- Network, 44

O

- OK prompt, 128
- Online
 - Registration, iii

P

- PON, 92
- Port Access, 75
- Port Properties
 - configuring, 90
 - restore defaults, 91
- Port Toolbar, 104
- Preferences, 83
- Properties, 90

R

- Rack Mounting
 - Front, 13

Rear, 15
Rear view
 KM0032, 10
 KM0532/KM0932, 9
Requirements, 4
 Operating Systems, 5
 OS Support, 5
Restore defaults, 91
Restoring default settings, 135
RoHS, ii
RS-232 Port Operation, 111

S

Safety Instructions
 General, 119
 Rack Mounting, 121
Scan, 87
Service Ports, 45
Sessions, 86
Show, 77
Single level installation, 18
SJ/T 11364-2006, ii
Skip Mode, 107
SMTP Settings, 47
Specifications, 132, 133
Stacking, 12
Stop-A keys, 128
Sun Solaris, 128
System, 55

System Requirements
 Consoles, 4

T

Technical Support, 122
Telephone Support, iii
Time, 52
Timeout, 43
Toolbar, 104
 Hotkey port switching, 106
 Icons, 105
Toolbar hotkey, 84
troubleshooting, 126
Trusted Certificates, 123

U

User Interface, 35
User interface
 Browser UI components, 39
 Browser UI main page, 38
 Console UI components, 36
User Management, 57
User management
 accounts, 57
User Notice, iii
Users
 assigning to groups, 65, 68
 removing from groups, 66, 70
Users and Groups, 65