

**BOSE**<sup>®</sup>

# Acoustic Wave<sup>®</sup> Music System II

Owner's Guide

Guía de usuario

Notice d'utilisation



## Please read this owner's guide

Please take the time to follow the instructions in this owner's guide carefully. It will help you set up and operate your system properly and enjoy all of its advanced features. Please save this owner's guide for future reference.

- WARNING:** To reduce the risk of fire or electrical shock, do not expose the product to rain or moisture.
- WARNING:** The apparatus shall not be exposed to dripping or splashing, and objects filled with liquids, such as vases, shall not be placed on the apparatus. As with any electronic products, use care not to spill liquids into any part of the system. Liquids can cause a failure and/or a fire hazard.
- CAUTION:** To reduce the risk of electric shock, do not disassemble this product unless you are qualified. Refer servicing to qualified service personnel.

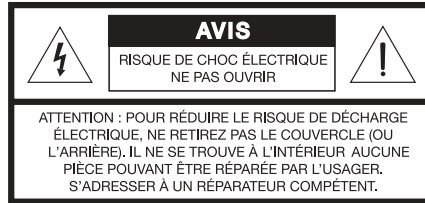
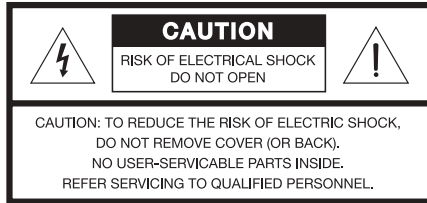

The lightning flash with arrowhead symbol within an equilateral triangle alerts the user to the presence of uninsulated, dangerous voltage within the system enclosure that may be of sufficient magnitude to constitute a risk of electrical shock.



The exclamation point within an equilateral triangle, as marked on the system, is intended to alert the user to the presence of important operating and maintenance instructions in this owner's guide.

## Class B emissions

This Class B digital apparatus meets all requirements of the Canadian Interference-Causing Equipment Regulations (Canada only).

- CAUTION:** To prevent electric shock, match the wide blade of the line cord plug to the wide slot of the AC (mains) receptacle. Insert fully.
- CAUTION:** Use of controls or adjustments or performance of procedures other than those specified herein may result in hazardous radiation exposure. The compact disc player should not be adjusted or repaired by anyone except properly qualified service personnel.

## Class 1 laser product

This CD player is classified as a CLASS 1 LASER PRODUCT according to EN 60825-1:1994+A1+A2, IEC 60825-1:1993+A1+A2.

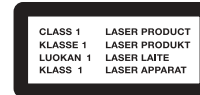

- WARNING:** Keep the remote control battery away from children. It may cause a fire or chemical burn if mishandled. Do not recharge, disassemble, heat above 100 °C (212 °F), or incinerate. Dispose of used batteries promptly. Replace only with a battery of the correct type and model number.
- WARNING:** Danger of explosion if battery is incorrectly replaced. Replace only with Duracell, Eveready, Energizer, Maxell, Toshiba, or Shun Wo CR2032 or DL2032 3-volt lithium battery.



**Please dispose of used batteries properly,** following any local regulations. Do not incinerate.

- WARNING:** No naked flame sources, such as lighted candles, should be placed on the apparatus.

**Note:** Where the mains plug or appliance coupler is used as the disconnect device, such disconnect device shall remain readily operable.

**CE** This product conforms to the EMC Directive 89/336/EEC and to the Low Voltage Directive 73/23/EEC. The complete Declaration of Conformity can be found at [www.bose.com/static/compliance/index.html](http://www.bose.com/static/compliance/index.html).

- CAUTION:** Using a 12-volt adapter other than the Bose 12V DC power cord or power pack can cause damage to your system.
- CAUTION:** When using the Acoustic Wave® music system II in a mobile environment such as an automobile, recreational vehicle, or boat, be sure that it is secured to prevent accidental movement.

1. **Read these instructions** – for all components before using this product.
2. **Keep these instructions** – for future reference.
3. **Heed all warnings** – on the product and in the owner's guide.
4. **Follow all instructions.**
5. **Do not use this apparatus near water or moisture** – Do not use this product near a bathtub, washbowl, kitchen sink, laundry tub, in a wet basement, near a swimming pool, or anywhere else that water or moisture are present.
6. **Clean only with a dry cloth** – and as directed by Bose Corporation. Unplug this product from the wall outlet before cleaning.
7. **Do not block any ventilation openings. Install in accordance with the manufacturer's instructions** – To ensure reliable operation of the product and to protect it from overheating, put the product in a position and location that will not interfere with its proper ventilation. For example, do not place the product on a bed, sofa, or similar surface that may block the ventilation openings. Do not put it in a built-in system, such as a bookcase or a cabinet that may keep air from flowing through its ventilation openings.
8. **Do not install near any heat sources, such as radiators, heat registers, stoves, or other apparatus (including amplifiers) that produce heat.**
9. **Do not defeat the safety purpose of the polarized or grounding-type plug. A polarized plug has two blades with one wider than the other. A grounding-type plug has two blades and a third grounding prong. The wider blade or third prong are provided for your safety. If the provided plug does not fit in your outlet, consult an electrician for replacement of the obsolete outlet.**
10. **Protect the power cord from being walked on or pinched, particularly at plugs, convenience receptacles, and the point where they exit from the apparatus.**
11. **Only use attachments/accessories specified by the manufacturer.**
12. **Use only with the cart, stand, tripod, bracket or table specified by the manufacturer or sold with the apparatus. When a cart is used, use caution when moving the cart/apparatus combination to avoid injury from tip-over.** 
13. **Unplug this apparatus during lightning storms or when unused for long periods of time** – to prevent damage to this product.
14. **Refer all servicing to qualified service personnel. Servicing is required when the apparatus has been damaged in any way: such as power-supply cord or plug is damaged; liquid has been spilled or objects have fallen into the apparatus; the apparatus has been exposed to rain or moisture, does not operate normally, or has been dropped** – Do not attempt to service this product yourself. Opening or removing covers may expose you to dangerous voltages or other hazards. Please call Bose to be referred to an authorized service center near you.
15. **To prevent risk of fire or electric shock, avoid overloading wall outlets, extension cords, or integral convenience receptacles.**
16. **Do not let objects or liquids enter the product** – as they may touch dangerous voltage points or short-out parts that could result in a fire or electric shock.
17. **See product enclosure bottom for safety-related markings.**

### **Information about products that generate electrical noise**

If applicable, this equipment has been tested and found to comply with the limits for a Class B digital device, pursuant to Part 15 of the FCC rules. These limits are designed to provide reasonable protection against harmful interference in a residential installation. This equipment generates, uses, and can radiate radio frequency energy and, if not installed and used in accordance with the instructions, may cause harmful interference to radio communications. However, this is no guarantee that interference will not occur in a particular installation. If this equipment does cause harmful interference to radio or television reception, which can be determined by turning the equipment off and on, you are encouraged to try to correct the interference by one or more of the following measures:

- Reorient or relocate the receiving antenna.
- Increase the separation between the equipment and receiver.
- Connect the equipment to an outlet on a different circuit than the one to which the receiver is connected.
- Consult the dealer or an experienced radio/TV technician for help.

**Note:** *Unauthorized modification of the receiver or radio remote control could void the user's authority to operate this equipment.*

This product complies with the Canadian ICES-003 Class B specifications.

## Important Safety Instructions

18. **Use proper power sources** – Plug the product into a proper power source, as described in the operating instructions or as marked on the product.
19. **Avoid power lines** – Use extreme care when installing an outside antenna system to keep from touching power lines or circuits, as contact with them may be fatal. Do not install external antennas near overhead power lines or other electric light or power circuits, nor where an antenna can fall into such circuits or power lines.
20. **Ground all outdoor antennas** – If an external antenna or cable system is connected to this product, be sure the antenna or cable system is grounded. This will provide some protection against voltage surges and built-up static charges.

Section 810 of the National Electrical Code ANSI/NFPA No. 70 provides information with respect to proper grounding of the mast and supporting structure, grounding of the lead-in wire to an antenna discharge unit, size of grounding conductors, location of antenna-discharge unit, connection to grounding electrodes, and requirements for the ground electrode. Refer to the antenna grounding illustration on this page.

### Antenna grounding

Example of antenna grounding as per National Electrical Code, ANSI/NFPA 70.

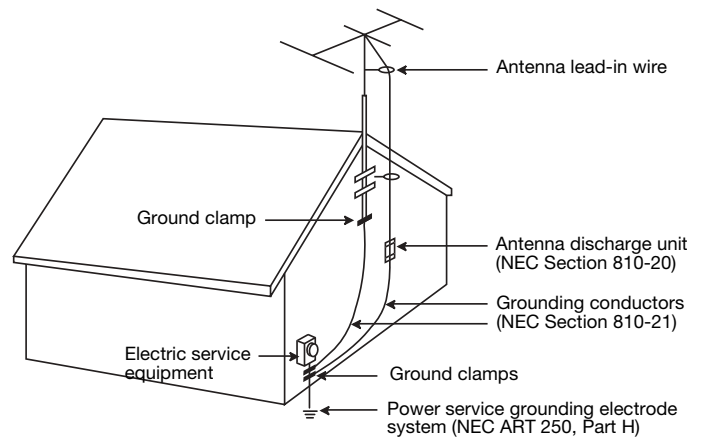

### Note to CATV system installer

This reminder is provided to call the CATV system installer's attention to Article 820-40 of the NEC (of USA) that provides guidelines for proper grounding. In particular, it specifies that the cable ground shall be connected to the grounding system of the building, as close to the point of cable entry as is practical.

<b>Setting Up Your Acoustic Wave® Music System II</b> .....	<b>4</b>
Unpacking .....	4
Selecting a location for your music system .....	4
Connecting to power .....	5
Getting started .....	5
<b>Operating Your Acoustic Wave® Music System II</b> .....	<b>6</b>
Introduction .....	6
Special features .....	6
Using the remote control .....	7
Using the control panel .....	8
Reading the display .....	9
Turning the system on and off .....	9
Controlling the volume .....	9
Operating on DC power .....	9
<b>Playing Compact Discs</b> .....	<b>10</b>
Playing audio CDs .....	10
Playing MP3 CDs .....	11
Changing CD play modes .....	12
Audio CD play modes .....	12
MP3 CD play modes .....	12
About MP3 CDs .....	13
<b>Listening to FM or AM Radio</b> .....	<b>14</b>
Selecting FM or AM radio .....	14
Tuning the radio .....	14
Storing a radio station to memory (Presets) .....	15
TALK RADIO mode .....	15
<b>Connecting Other Equipment</b> .....	<b>16</b>
Rear panel input/outputs .....	16
Connecting an external FM antenna .....	16
Using headphones .....	17
Connecting external speakers .....	17
Connecting a recording device .....	18
Using the AUX IN input .....	18
Connecting your Acoustic Wave® music system II to a Lifestyle® system .....	19
<b>Personalizing Your Acoustic Wave® Music System II</b> .....	<b>20</b>
Factory settings .....	20
Changing system settings .....	20
<b>Maintaining Your Acoustic Wave® Music System II</b> .....	<b>22</b>
Cleaning .....	22
Replacing the remote control battery .....	22
Troubleshooting .....	23
Customer support .....	24
Limited warranty .....	24
Technical information .....	24

## Unpacking

Carefully unpack your music system. Save all packing materials for possible future use. The original packing materials provide the safest way to transport your Acoustic Wave® music system II. If any part of the product appears damaged, do not attempt to use it. Notify Bose® Customer Service immediately (see phone numbers on the inside back cover).

Check to be sure you received the parts identified in Figure 1.

**WARNING:** To avoid danger of suffocation, keep the plastic bags out of the reach of children.

**Figure 1**

Carton contents

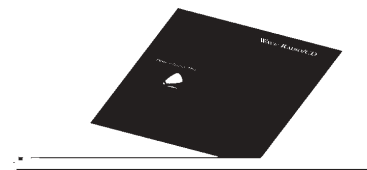

## Connecting to power

1. Plug the small end of the power cord into the power jack on the back of your Acoustic Wave® music system II (Figure 2).
2. Plug the other end of the power cord into an AC power (mains) outlet.

**Figure 2**

*Connecting the power cord*



## Introduction

Thank you for purchasing the Bose® Acoustic Wave® music system II, engineered to deliver the deep, rich musical performance you would expect from a large, complicated component stereo system.

Over 20 years of research by Bose Corporation brings you the benefits of award-winning, patented acoustic waveguide speaker technology. Using this technology, long waveguides folded into intricate patterns can be built into products that are small enough to fit comfortably in your home. This long waveguide, or tube, efficiently transfers energy from a small speaker to the outside air over a wide range of low frequencies. Your Acoustic Wave® music system II features an 80-inch waveguide, precisely tuned to deliver sound reproduction unlike anything you may have heard from a system this size.



## Special features

### **You easily can move the system from room to room, or even outside**

Your Acoustic Wave® music system II has molded inset handles for easy carrying. Optional accessories let you enjoy the system in places outside of your home.

- Carrying case allows you to listen to your system while protecting it during transport.
- Rechargeable power pack enables operation when AC power is not available.
- DC power cord plugs into the cigarette lighter receptacle in your automobile.

You can purchase accessories from your Bose® dealer, on the Internet ([www.bose.com](http://www.bose.com)), or by phone. See the inside back cover for contact information.

### **Enjoy talk radio programs using a special listening mode**

Some talk radio programs can sound unnatural or bass-heavy. Your Acoustic Wave® music system II has a user-selectable TALK RADIO mode that automatically adjusts the sound, making the programs sound more natural. For details, see “TALK RADIO mode” on page 15.

### **Connect headphones for private listening**

You can plug your headphones into the HEADPHONES output jack on the rear panel. Use the volume control on the top control panel to set the level. See “Using headphones” on page 17.

### **Expand your system by connecting additional speakers**

You can deliver music to another area in your home by connecting a powered speaker system to the HEADPHONES output. For instructions on setting up the system for this, see “Connecting external speakers” on page 17.

### **Record your favorite programs**

The HEADPHONES output on the rear panel also can be used to record your favorite music or talk program. To connect a recorder, see “Connecting a recording device” on page 18.

### **Play your favorite music file (MP3) CDs**

Your Acoustic Wave® music system II can play MP3 music files recorded on CD-R and CD-RW discs. For more information, see “Playing MP3 CDs” on page 11.



## Using the remote control

The remote control allows you to fully operate all the common functions of your Acoustic Wave® music system II. Just aim the remote at the system and press the buttons. The remote normally works within 20 feet from the front panel.

### Notes:

- Press-and-hold operations require holding the button down for at least one second.
- Pressing FM, AM, CD, or AUX automatically turns on the system to the source selected.

**Figure 3**

Remote control buttons

### On/Off

Turns system power on or off (page 9).

### FM/AM/CD/AUX

Selects the FM/AM radio, CD, or AUX source, and automatically turns on the system if it is off (page 9-12 & 18-19).

### Volume

Raises or lowers the volume (page 9).

### Seek/Track

For FM/AM radio

- Press: Finds the next/previous radio station with a strong signal (page 14).
- Press and hold: Rapidly moves forward/backward through radio frequencies with a strong signal (page 14).

For CDs

- Press: Skips to next/previous CD track (page 10).
- Press and hold: Rapidly skips to next/previous CD track (page 10).



### Mute

Press to silence audio. Press again to restore audio (page 9).

### Presets

- Press: Recalls a stored radio station (page 15).
- Press and hold: Stores a radio station for quick recall (page 15).

### Play/Pause

Plays a CD or pauses a playing CD (page 10).

### Stop

Stops a playing CD (page 10).

### Play Mode

- Selects shuffle and repeat CD play modes (page 12).
- Turns TALK RADIO mode on or off for AM or FM (page 15).

### Tune/MP3

For FM/AM radio

- Press: Skips to next/previous FM/AM frequency (page 14).
- Press and hold: Rapidly moves up/down through radio frequencies (page 14).

For CDs

- Press: Navigates through folders on MP3 CDs (page 11).
- Press and hold: Scans forward/backward through a CD track (page 10).

**Throughout this owner's guide, you will see button icons to the left of the operating instructions. These icons refer to buttons located on the remote control.**

## Using the control panel

The control panel has the same buttons as the remote except that the control panel has a **Menu** button and it does not have a **Mute** button.

**Figure 4**

Control panel buttons

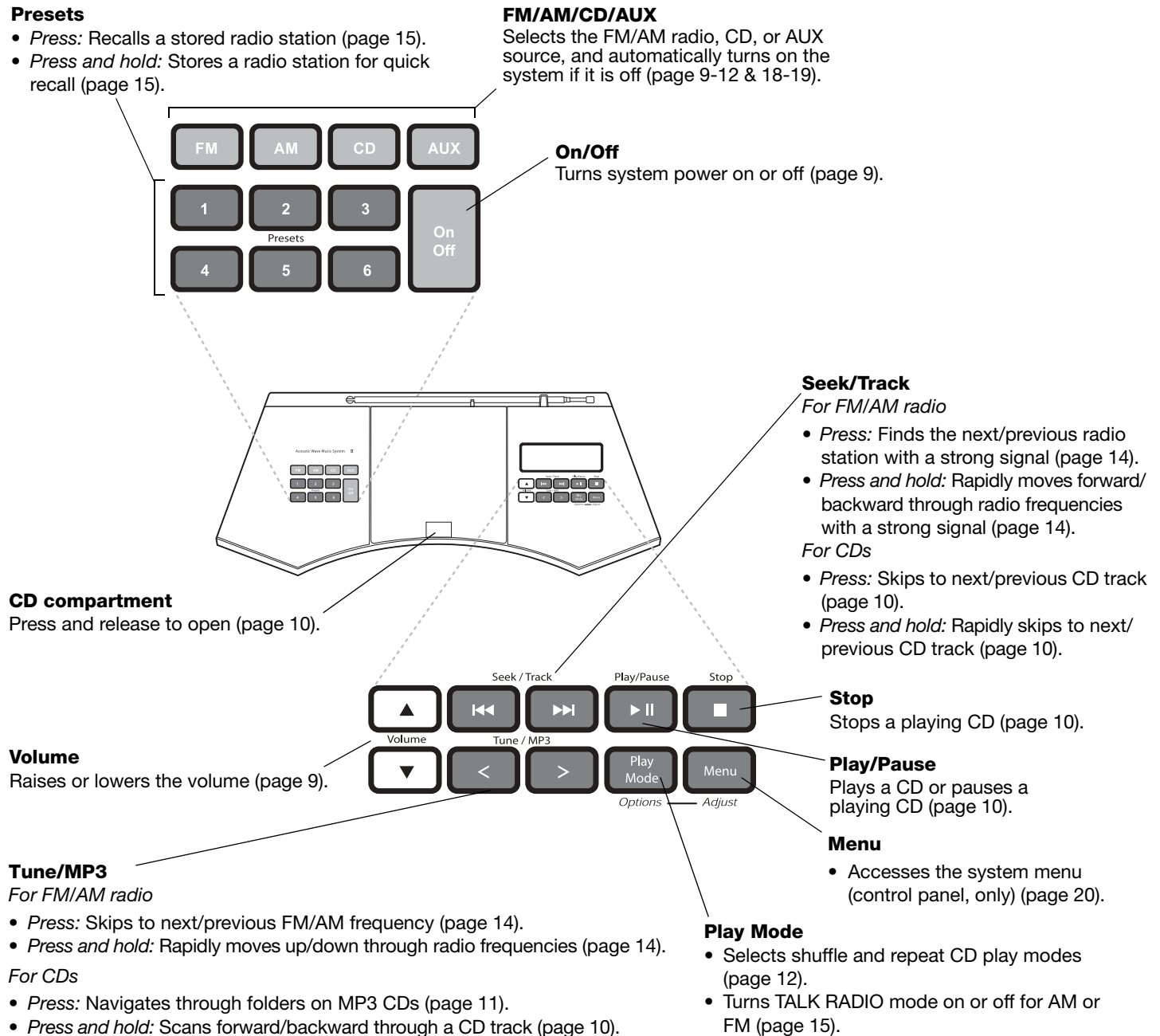

## Reading the display

The example in Figure 5 describes the types of information that can appear on the display.

### Figure 5

Sample display with CD information

Indicates the selected source: FM, AM, CD, or AUX.

Additional source-related information such as FM/AM preset number, or elapsed CD play time.

Source information or system menu items.



Source status information, such as CD play mode, volume level, and mute indicator.

## Turning the system on and off



### Playing audio CDs

CD

1. Press and release the tab on the top of the CD compartment cover to open it (Figure 7).
2. Insert a CD, label side up, into the player.
3. Push the cover down to close it.
4. Press **CD** if the CD source is not selected. The system turns on and starts to play the CD. CD source information is displayed (Figure 8).

#### Figure 7

Loading a CD

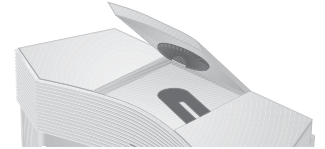

## Playing MP3 CDs

Your Acoustic Wave® music system II can play MP3 music files recorded on CD-Rs and CD-RWs. For information on how MP3 CDs work, see “About MP3 CDs” on page 13.

### To play an MP3 CD:

Insert the CD into the CD compartment. If you were listening to another source, press **CD**. The MP3 CD will start playing automatically. Initially, elapsed track time appears at the top of the display (Figure 10). The folder and track number appear across the middle. Following this, track and artist name appear twice followed by the song title again (Figure 11). The elapsed time and song title remain on the display while the track plays. Press **CD** to view the folder number, track number, song title, and artist name again.

**Figure 10**

Sample of an initial display for an MP3 CD

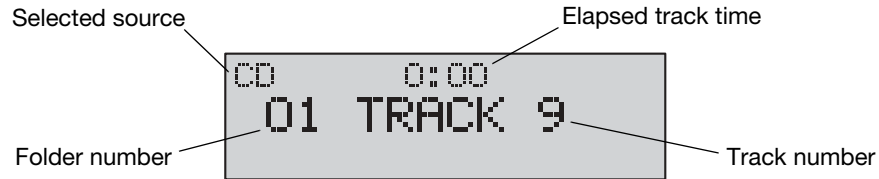

**Note:** The root level (or first-level folder) is displayed as Folder Number 00.

**Figure 11**

Sample of a display for an MP3 CD that is playing

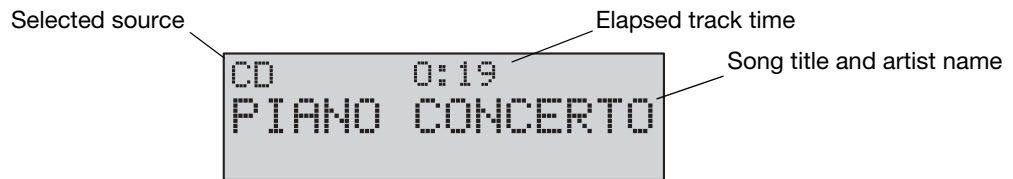

Play / Pause



Press **Play/Pause** to pause a playing MP3 CD. The elapsed time and the CD PAUSED indicator flashes on the display. Press **Play/Pause** again to resume play.

### While an MP3 CD track is playing:

Play / Pause



- Press **Play/Pause** to pause a playing MP3 CD. The elapsed time and the CD PAUSED indicator flashes on the display. Press **Play/Pause** again to resume play.

Seek/Track



- Press **Seek/Track** **⏮** to skip to the beginning of the current track. Press again within three seconds to skip to the beginning of the previous track.
- Press **Seek/Track** **⏭** to skip to the next track.

Tune/MP3

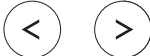

- Press **Tune/MP3** **<** to skip to the previous folder (if folders are used); press **Tune/MP3** **>** to skip to the next folder.
- Press and hold **Tune/MP3** **<** or **Tune/MP3** **>** to quickly scan backward or forward through a track.

Stop



- Press **Stop** to stop an MP3 CD.

## Changing CD play modes

While a CD is playing, the selected play mode affects how tracks are played.



Press **Play Mode** repeatedly until the play mode you want is displayed.

### Audio CD play modes

When playing an audio CD, these are the available play modes.

<i>Displayed mode</i>	<i>Description</i>
NORMAL PLAY	Plays all tracks once in sequential order.
SHUFFLE DISC	Plays all tracks once in random order.
SHUFFLE REPEAT	Repeats all tracks in a random order.
REPEAT DISC	Repeats the disc from the beginning after the last track is played.
REPEAT TRACK	Repeats the selected track continuously.

### MP3 CD play modes

When playing an MP3 CD, these are the available play modes.

<i>Displayed mode</i>	<i>Description</i>
NORMAL PLAY	Plays all tracks once in sequential order.
SHUFFLE DISC	Plays all tracks once in random order.
SHUFFLE FOLDER	Plays all tracks in the selected folder in random order.
SHUFFLE RPT FLDR	Repeats all tracks in a folder in random order.
SHUFFLE REPEAT	Repeats all tracks in a random order.
REPEAT DISC	Repeats the disc from the beginning after the last track is played.
REPEAT FOLDER	Repeats all tracks in a folder in order.
REPEAT TRACK	Repeats the selected track continuously.

## About MP3 CDs

MP3 is a music compression technology that reduces a song's file size without noticeable effect in the quality of the sound. The MP3 format makes it possible for you to store many more songs on a single CD than found on a conventional audio CD. In fact, an MP3 CD can contain as much music as 10 standard audio CDs on just one disc, which then can be organized into folders on a computer before being stored on the disc.

The order in which MP3 songs are played is determined by how the MP3 files are organized and stored on the CD. For example, Figure 12 shows the play order of songs that are organized into four folders.

**Figure 12**

*Example of MP3 CD file organization*

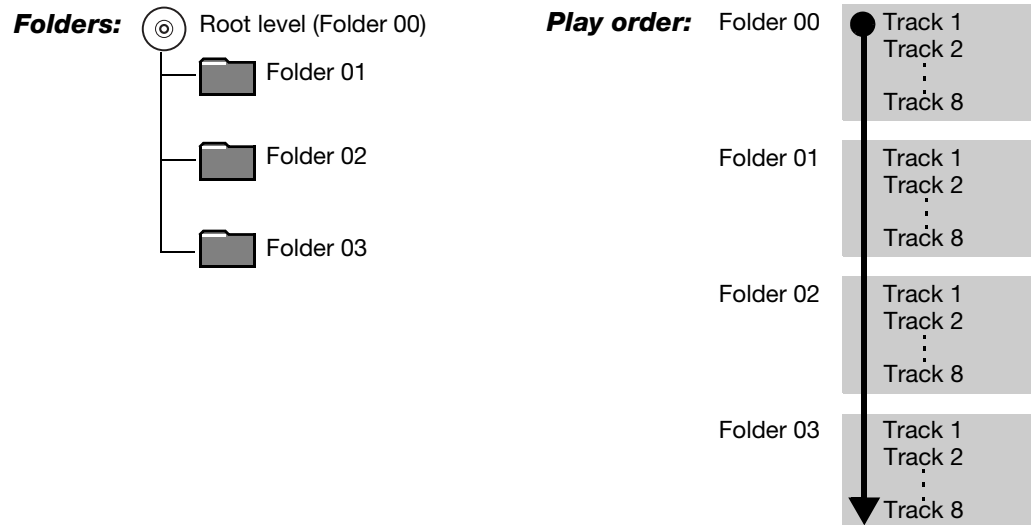

The audio quality of MP3 CDs is dependent on factors such as the encoded bit rate, the sampling rate, and the type of encoder used. The Acoustic Wave® music system II supports MP3 CDs encoded at bit rates of 64kbps or higher, and sampling rates of 32kHz or higher. It is recommended that a bit rate of at least 128kbps and a sampling rate of 44.1kHz or higher be used.

🎵 **Note:** Playback quality of recorded CD-Rs and CD-RWs is dependent on the CD recording process and software used to record the disc. An improperly recorded audio CD may cause the system to exhibit unexpected behavior.

## Selecting FM or AM radio



Press **FM** or **AM** to select FM or AM radio. This action also turns on the system if it is off. The last radio station selected will be heard.

**Figure 13**

Sample FM radio display



## Tuning the radio



Press **FM** or **AM** to select the FM or AM tuner.

When you tune to a radio station, the frequency appears in the center of the display while you are tuning (Figure 14).

**Figure 14**

Sample tuning display

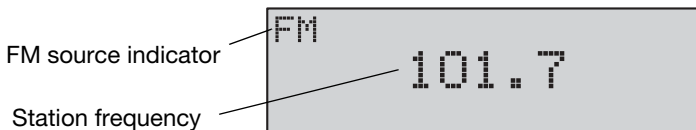

Press **Seek/Track** **◀◀** to find a lower-frequency station with a strong signal; press **Seek/Track** **▶▶** to find a higher-frequency station with a strong signal.



Press **Tune/MP3** **<** to manually tune to a lower frequency; press **Tune/MP3** **>** to manually tune to a higher frequency.

Press and hold **Tune/MP3** **<** to move rapidly down through the frequency band; press and hold **Tune/MP3** **>** to move rapidly up through the frequency band.

**Note:** If AM reception is weak, rotate the system to improve AM reception. If FM reception is weak, make sure the telescoping antenna is fully extended. If FM reception is still weak, try installing an external FM antenna. See "Connecting an external FM antenna" on page 16.



## Storing a radio station to memory (Presets)

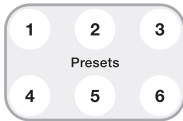

You can store up to six FM and six AM radio stations for quick recall using the **Presets** buttons.

1. Tune to the station you want to save as a preset.
2. Press and hold one of the six **Presets** buttons until you hear a double beep and the preset number and station frequency appear on the display.
3. Press one of the **Presets** buttons to quickly tune to a previously stored FM or AM station.

🎵 **Note:** Storing a preset will replace any station previously stored to that preset number.

🎵 **Note:** During a power outage, stored presets are retained in a backup memory system.

## TALK RADIO mode

Talk radio broadcasts can be greatly affected by either the microphone selection or the boosting of low frequencies by some radio stations. They do so in an attempt to improve speech when heard through conventional radios. In high-quality audio products, this results in sound that is unnatural or bass-heavy. By selecting the TALK RADIO mode, your Acoustic Wave® music system II automatically adjusts to compensate for artificially boosted low frequencies.



Press **Play Mode** while the radio is playing to turn on the TALK RADIO mode. When on, **TALK RADIO** is displayed under the station frequency (Figure 15). Press **Play Mode** again to turn off the TALK RADIO mode.

**Figure 15**

Sample FM radio display with TALK RADIO on



TALK RADIO Mode indicator

🎵 **Note:** The TALK RADIO mode is cancelled when you press any source button, tune to another station, or turn off your Acoustic Wave® music system II.

### Rear-panel input/outputs

The rear panel of your Acoustic Wave® music system II provides connections for external equipment (Figure 16).

**Figure 16**

*Rear-panel connections*

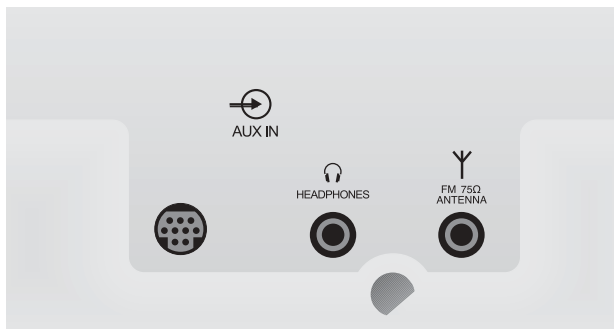

## Using headphones

For private listening, you can connect headphones to your Acoustic Wave® music system II.

**▲ WARNING:** *DO NOT use headphones if the HEADPHONES jack is set up to operate speakers. The high output volume level may cause hearing damage. Set the HEADPHONES JACK menu option to HEADPHONES before plugging in your headphones. See “Changing system settings” on page 20.*

**▲ WARNING:** *Long-term exposure to loud music may cause hearing damage. It is best to avoid extreme volume when using headphones, especially for extended periods.*

1. Plug your headphones cable into the **HEADPHONES** jack on the rear panel (Figure 18). The speakers are automatically muted while headphones are connected.



Volume



2. Check the volume level. You may want to lower the setting before putting the headphones on your head.

3. Press **Volume ▲** or **▼** to adjust the listening level of your headphones.

**Figure 18**

Headphones connection

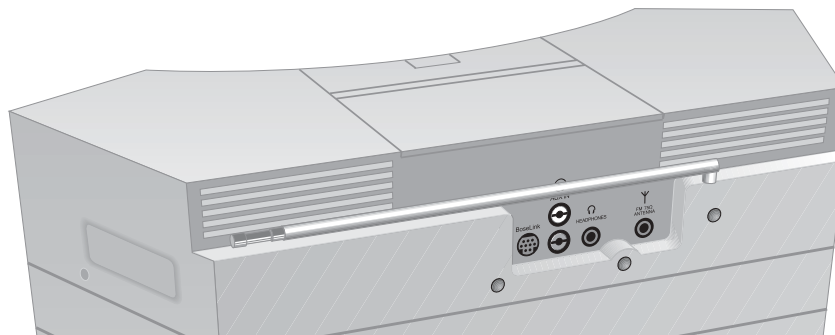

### Connecting a recording device

To record audio programming from your system, you can connect a recording device to the HEADPHONES jack.

To make the connection, you will need a stereo cable (not supplied) that has a 3.5 mm (1/8") male stereo plug on one end and the required connectors for the recording device on the other end. The example at the right shows dual RCA connectors for the device.

Cable example: 3.5 mm (1/8") male to Dual RCA male stereo cable

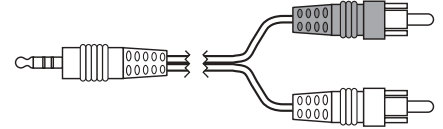

1. In the setup menu, change the HEADPHONES JACK option from HEADPHONES to LINE OUTPUT. See "Changing system settings" on page 20 for instructions.
2. Connect the recording device to the HEADPHONES jack using the required cable.

### Using the AUX IN input

When using a TV, VCR, computer, video game or MP3 player, you can enhance your listening experience by playing the audio output of these devices through the **AUX IN** input on your Acoustic Wave® music system II.

Connecting the audio output of a device to your Acoustic Wave® music system II requires one of the following types of stereo cables (not supplied):

- Dual RCA male to 3.5 mm (1/8") male stereo cable
- Dual RCA male to Dual RCA male stereo cable

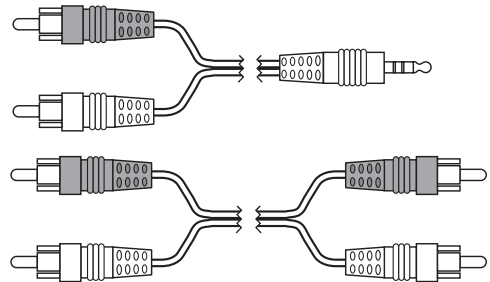

#### To connect a device, like an MP3 player, to your music system:

1. Connect the dual RCA plugs of the appropriate stereo cable to the **AUX IN** connectors on the rear panel of your Acoustic Wave® music system II (Figure 19).
2. Connect the other end of the cable to the audio output of the device.
3. Turn on the connected device, and then turn on your Acoustic Wave® music system II.
4. Press **AUX**.

AUX



5. Press and hold **Volume ▲** or **Volume ▼** to adjust the volume. The volume level (loud) appears on the display to indicate the level. The volume of the Wave® music system II cannot be adjusted when a connected device is playing.

**Figure 19**

*Connecting an MP3 player to the AUX IN connectors*

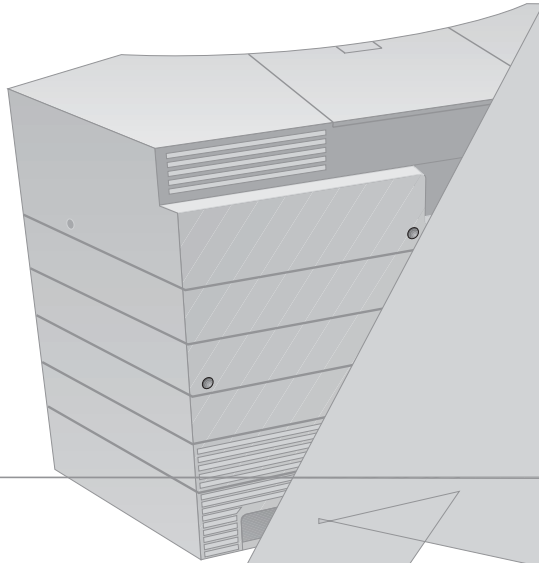

## Factory settings

System settings were chosen at the factory to satisfy most owners of an Acoustic Wave® music system II. However, if you wish to change any of the system settings and personalize your system, use the system setup menu.

## Changing system settings

To change system settings, perform the following steps. Refer to Figure 20 and the setup menu table on page 21.

1. Press and hold **Menu** until --SETUP MENU-- is displayed.
2. Press **Options** until the menu option you want to change is displayed.
3. Press **Adjust** to change the value or selection.
4. Repeat Steps 2 and 3 as necessary to make other changes.
5. Press any button other than **Menu** or **Play Mode** to exit the setup menu. If you don't press any button, the system automatically will exit the setup menu after 10 seconds.

**Figure 20**

Controls used for changing system settings

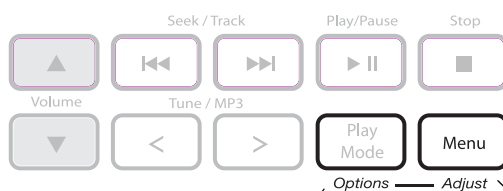

**Play Mode - Options**



Selects the setup menu option you want to change.

**Menu - Adjust**

- *Press and hold*: Accesses the setup menu.
- *Press*: Changes the setting for the selected option.



## Setup menu

 Play Mode <i>Options</i> <b>Menu Option</b>	<b>Displayed name</b>	 Menu <i>Adjust</i> <b>Choices*</b>	<b>Description</b>
Headphones jack	HEADPHONES JACK:	<b>HEADPHONES</b> , LINE OUTPUT	The HEADPHONES jack is set at the factory for connecting headphones to your system. You can connect powered speakers to this jack if you change the HEADPHONES JACK option to LINE OUTPUT. <ul style="list-style-type: none"> <li>• <b>HEADPHONES</b>: provides a variable output and mutes the system speakers.</li> <li>• <b>LINE OUTPUT</b>: provides a fixed output and does not mute the system speakers.</li> </ul> For more information, see “Using headphones” and “Connecting external speakers” on page 17, and “Connecting a recording device” on page 18.
Continuous Play	CONTINUOUS PLAY:	<b>NO</b> , FM, AM, AUX	Your Acoustic Wave® music system II has a continuous play feature. When a CD stops playing, you can program another source to automatically start playing.
Expansion Room	ROOM SELECTION:	<b>B</b> , C, D, E, F, G, H, I, J, K, L, M, N, O	Sets the room code for your Acoustic Wave® music system II when it is connected to a Lifestyle® system through a Bose® link network. For more information, see “Connecting your Acoustic Wave® music system II to a Lifestyle® system” on page 19.
System Reset	RESET ALL:	<b>NO</b> , YES	Restores the system to factory settings.* <ol style="list-style-type: none"> <li>1. Change RESET ALL: NO to RESET ALL: YES.</li> <li>2. While the message “PRESS 2 TO CONFIRM” is blinking on the display, press the <b>Preset 2</b> button.</li> <li>3. After “RESET COMPLETE” appears on the display, wait for the system to turn itself off (about 2 seconds) and back on again.</li> </ol> <p><b>Note:</b> This function also returns FM and AM presets to factory settings. If you have stored presets for your favorite radio stations, you will need to enter them again after the system reset is completed.</p>

\*Factory settings are in bold type.

### Cleaning

Use only a soft dry cloth to clean the enclosure of your Acoustic Wave® music system II. If necessary, you may use a soft-bristled attachment to gently vacuum the front of the enclosure. Do not use any liquid cleaning solutions, solvents, chemicals, alcohol, ammonia, or abrasives.

**⚠ CAUTION:** Do not allow liquids to spill into any openings in the enclosure. If liquids get into the unit, turn it off immediately. Call Bose® Customer Support as soon as possible to arrange for service. See the list of phone numbers inside the back cover.

### Replacing the remote control battery

Your remote control comes with the battery installed. When you need to replace an expired battery, refer to the following steps.

1. Place the remote control face down on a flat surface.
2. Using your finger, push the tab lock to the side as shown and hold. Slide the battery compartment open.
3. Keeping the remote control face down, insert the new battery into the compartment with the + symbol facing up.
4. Gently slide the battery compartment closed. It locks automatically.

#### Figure 21

Battery removal and installation

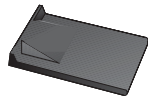



## Troubleshooting

<b>Problem</b>	<b>What to do</b>
System does not function	<ul style="list-style-type: none"> <li>• Make sure the power cord is fully plugged into both the system and a live electrical outlet.</li> </ul>
No sound	<ul style="list-style-type: none"> <li>• Turn up the volume.</li> <li>• Press and release <b>Mute</b> until –MUTE– is not flashing in the display window.</li> <li>• Remove the CD from the CD player and re-seat it.</li> <li>• Check connections for an auxiliary source.</li> <li>• Press <b>AUX</b> to listen to an external source connected to the <b>AUX IN</b> input. Make sure the external source is plugged in and turned on.</li> <li>• Disconnect headphones.</li> </ul>
FM reception is weak	<ul style="list-style-type: none"> <li>• If you are using the telescoping antenna, make sure it is fully extended.</li> <li>• Try the external antenna included with your system. Refer to “Connecting an external FM antenna” on page 16 for instructions.</li> </ul>
AM reception is weak	<ul style="list-style-type: none"> <li>• Adjust the internal antenna by rotating the unit slightly one way and then the other.</li> <li>• Move the unit farther from a TV, refrigerator, fluorescent lamps, halogen lamps, dimmer switches, or other electronic equipment that generates electrical noise.</li> <li>• If neither suggestion works, you may be in an area of weak AM signal coverage.</li> </ul>
Remote control is inconsistent or does not work	<ul style="list-style-type: none"> <li>• Operate the remote control closer to the unit.</li> <li>• Be sure to aim the remote at the system when pressing a button.</li> <li>• Check for interference from room lighting, sunlight, or dust or dirt on lens.</li> <li>• Try the unit in a different location.</li> <li>• Check that the remote control battery is installed properly. See “Replacing the remote control battery” on page 22.</li> <li>• Replace the remote control battery. See “Replacing the remote control battery” on page 22.</li> </ul>
Display window is blank	<ul style="list-style-type: none"> <li>• Make sure the system is plugged into a live AC or DC power source, and turned on.</li> </ul>
The display backlight does not stay on	<ul style="list-style-type: none"> <li>• If the system is operating on DC power, the backlight is normally off. Pressing any control panel button turns on the backlight only for a brief time.</li> </ul>
CD does not play	<ul style="list-style-type: none"> <li>• Check that the CD source is selected. The letters “CD” should appear in the upper left corner of the display. If not, press <b>CD</b>.</li> <li>• Check that the CD was loaded label-side up.</li> <li>• Check that the disc surface is clean. If not, try cleaning it.</li> <li>• Check that an audio CD was loaded, not a DVD.</li> <li>• Try another disc.</li> </ul>
“NO DISC” appears on the display	<ul style="list-style-type: none"> <li>• Open the CD compartment and make sure a CD was inserted label-side up.</li> </ul>
“DOOR OPEN” appears on the display	<ul style="list-style-type: none"> <li>• Make sure the CD compartment is closed.</li> </ul>
“NOT PLAYABLE” appears (blinking) on the display	<ul style="list-style-type: none"> <li>• The CD format is not supported.</li> </ul>
“TRACK [track #] ERROR” appears on the display	<ul style="list-style-type: none"> <li>• Skip to another track and press <b>Play</b>, or try another CD.</li> </ul>
CD skips	<ul style="list-style-type: none"> <li>• Clean the CD.</li> <li>• Make sure the system is not getting bumped. Move it if necessary.</li> </ul>

### **Customer support**

If you lose your remote, additional remotes are available from Bose® Customer Support. For additional help in solving problems, contact Bose Customer Support. See the phone numbers listed inside the back cover of this guide.

### **Limited warranty**

Your Acoustic Wave® music system II is covered by a limited transferable warranty. Details of the limited warranty are provided on the product registration card that is included in the carton. Please complete the information section on the card and mail it to Bose. Failure to do so will not affect your limited warranty rights.

### **Technical information**

#### **AC power rating**

USA/Canada: 120V~ 50/60Hz, 60W

International: 220-240V~ 50/60Hz, 60W

#### **Dimensions**

10<sup>5</sup>/<sub>8</sub>"H x 18"W x 7<sup>3</sup>/<sub>8</sub>"D (27cm x 45.7cm x 18.7cm)

#### **Weight**

14.5 lb (6.5 kg)





**USA Customer Support**

Bose Corporation, The Mountain  
Framingham, MA 01701-9168  
1-800-367-4008

**United Kingdom  
Customer Support**

Freepost EX 151  
Exeter EX1 1ZY  
TEL 0800 614 293

**Canada Customer Support**

Bose Ltd., 1-35 East Beaver Creek Rd.  
Richmond Hill, Ontario L4B 1B3  
1-800-465-2673

**European Office**

Bose Products B.V., Nijverheidstraat 8  
1135 GE Edam, Nederland  
TEL 0299-390111  
FAX 0299-390114

**Australia**

Bose Pty Limited,  
Unit 3, 2 Holker Street,  
Newington NSW, 2127  
TEL +61 (0)2 8737 9999  
FAX +61 (0)2 8737 9924

**Deutschland**

Postfach 1468  
48504 Nordhorn  
TEL 05921 3030 123  
FAX 05921-724250

Bose AG  
Hauptstraße 134  
CH-4450 Sissach  
TEL 061 975 77 33  
FAX 061 975 77 44

Bose Ges.m.b.H  
Wienerbergstraße 7  
A-1100 Wien  
TEL 01 604 043 40  
FAX 01 604 043 423

**France**

Bose S.A.S  
12 rue de Témara  
F-78100 ST. GERMAIN-EN-LAYE  
France  
TEL 0820 820 995  
FAX 01 30 61 63 88



20064 011

***BOSE***<sup>®</sup>  
*Better sound through research*<sup>®</sup>

©2006 Bose Corporation, The Mountain,  
Framingham, MA 01701-9168 USA  
AM292564 Rev.00