

IMPORTANT MANUAL

Do Not Throw Away

WEED EATER

TRADEMARK®

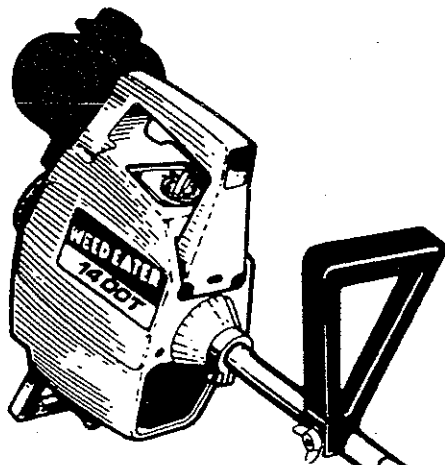

OPERATOR'S MANUAL:

▲WARNING: Read the Operator's Manual and Follow All Warnings and Safety Instructions. Failure To Do So Can Result in Serious Injury.

Always Wear Eye Protection During Operation

Model:
1400T *Trimmer*

MANUFACTURED UNDER ONE OR MORE OF THE FOLLOWING U.S. PATENTS: 3,708,967; 3,826,068; 3,859,776; 4,035,912; 4,052,789; 4,054,922; 4,067,108; 4,104,797; 4,114,269; 4,124,938; 4,156,312; 4,156,967; 4,161,820; 4,167,812; 4,269,372; 4,269,675; 4,508,068; DES. 249,630; DES. 255,764; DES. 260,394. U.S. AND FOREIGN PATENTS PENDING.

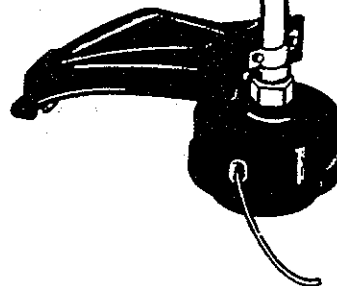
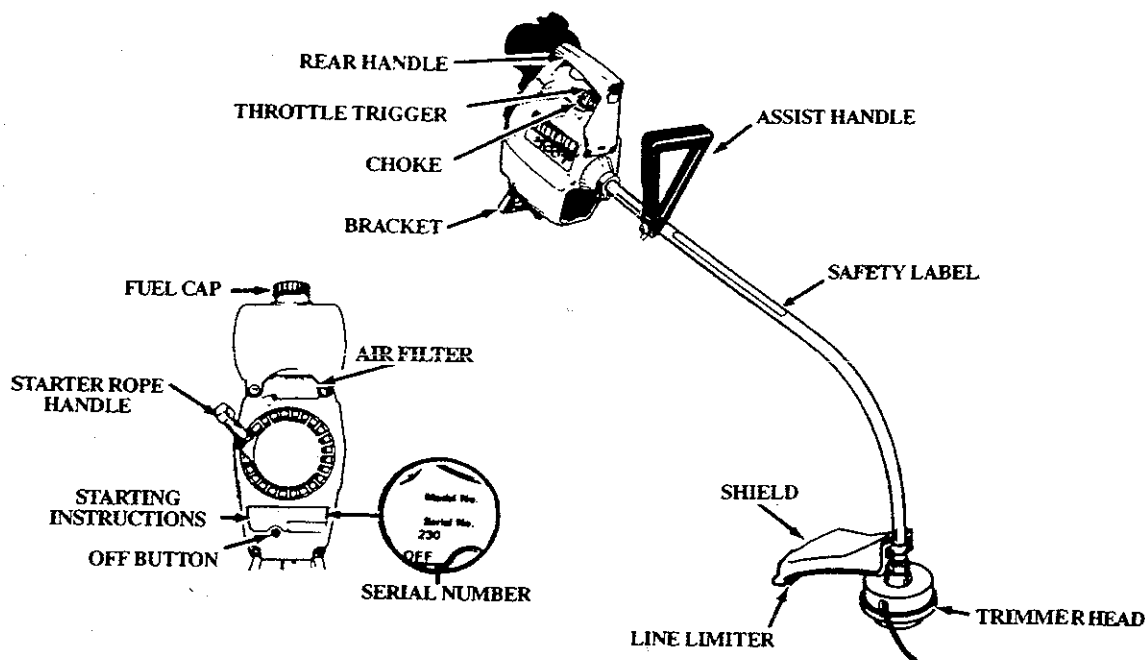

TABLE OF CONTENTS

WARNINGS AND SAFETY INSTRUCTIONS	3	GENERAL MAINTENANCE	15
KNOW YOUR TRIMMER	6	A. Maintenance Safety	15
ASSEMBLY	7	B. Starter Rope	16
ENGINE INFORMATION	9	C. Flexible Drive Shaft Lubrication	17
A. Fueling Your Engine	9	D. Carburetor Adjustments	18
B. Pre-Operation Checks	10	E. Air Filter	18
C. Starting Instructions	10	F. Trouble Shooting Chart	19
D. Operating Instructions	11	WEED EATER® ACCESSORIES	19
USING YOUR TRIMMER	11	PARTS AND SERVICE	Back Cover
A. Line Trimmer Safety	12		
B. Trimmer Line Advance	12		
C. Cutting Methods	13		
D. Line Replacement	14		

SPECIFICATIONS

ENGINE TYPE:	2-Cycle, Air-Cooled	FUEL TANK:	13.5 fl. oz.
DISPLACEMENT:	22.2 cc.	SPARK PLUG:	Champion CJ-14
ENGINE RPM:	Operating — 6500 - 7500 Idle — 2800 - 3200	SPARK PLUG GAP:	.025"
IGNITION:	Solid State	MODULE AIR GAP:	.010" / .014"
CARBURETOR:	Diaphragm All Position with adjustable fuel mixture jets	LUBRICATION:	Gasoline/Oil Mix (See "Fueling Your Engine")
ENGINE "OFF":	Push Button	CUTTING LINE:	.080" Diameter, monofilament
STARTER:	Auto Rewind	MUFFLER:	Temperature Limiting (not spark arresting)



SPECIAL NOTICE

For users on U.S. Forest Land in the states of California, Maine, Oregon, and Washington. All U.S. Forest Land in the states of California (Public Resources Codes 4442 and 4443), Oregon, and Washington require, by law, that certain internal combustion engines operated on forest, brush, and/or grass-covered areas be equipped with a spark arrester maintained in effective working order or the engine be constructed, equipped, and maintained for the prevention of fire. Check with your state or local authorities for regulations pertaining to these requirements. Failure to follow these requirements are a violation of the law. **This unit is not factory-equipped with a spark arrester;** however, a spark arrester is available as an optional part. If this item is required in your area, order Part #952-701612 from your dealer.

⚠ WARNINGS AND SAFETY INSTRUCTIONS

⚠ WARNING — THIS POWER TOOL CAN BE DANGEROUS!

This tool can cause serious injury or blindness to the operator and others. The warnings and safety instructions in this manual must be followed to provide reasonable safety and efficiency in using this tool. The operator is responsible for following the warnings and instructions in this manual and on the tool. **Read the entire Operator's Manual before assembling and using this tool!** Restrict the use of this power tool to persons who read, understand, and follow the warnings and instructions in this manual and on the tool.



⚠ DANGER

NEVER USE BLADES WITH THIS TOOL.

- THE BLADE CAN COME OFF AND SERIOUSLY INJURE YOU AND OTHERS.
- THIS TOOL IS DESIGNED FOR LINE TRIMMER USE ONLY.

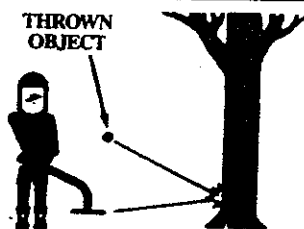

⚠ WARNING

THE TRIMMER LINE CAN THROW OBJECTS VIOLENTLY.

- YOU CAN BE BLINDED OR INJURED.
- WEAR EYE AND LEG PROTECTION.

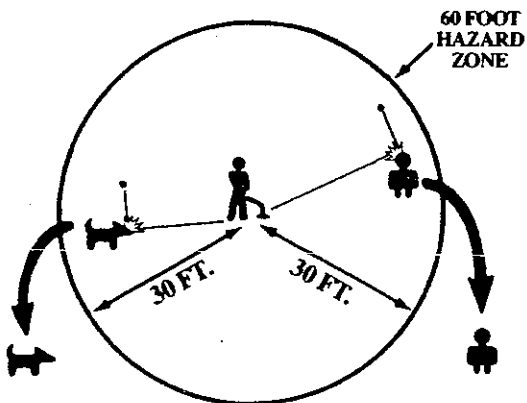

⚠ WARNING

HAZARD ZONE FOR THROWN OBJECTS.

- THE TRIMMER LINE CAN THROW OBJECTS VIOLENTLY.
- OTHERS CAN BE BLINDED OR INJURED.
- KEEP PEOPLE AND ANIMALS 30 FEET AWAY.



OPERATOR'S
MANUAL



SAFETY
LABEL

⚠ WARNING

READ OPERATOR'S MANUAL.

- FOLLOW ALL WARNINGS AND INSTRUCTIONS.
- FAILURE TO DO SO CAN RESULT IN SERIOUS INJURY.

TURN PAGE →

NOTES

▲ WARNINGS AND SAFETY INSTRUCTIONS (Continued)

▲ OPERATOR SAFETY

1. Always wear a safety face shield or safety goggles. See "Accessories."
2. Always wear heavy, long pants, boots and gloves. Do not wear loose clothing, jewelry, short pants, sandals or go barefoot. Secure hair so it is above shoulder length. Being fully covered will help protect you from pieces of toxic plants such as poison ivy thrown by the Trimmer Head which could be more of a hazard than touching the plant itself.
3. Do not operate this tool when you are tired, ill, or under the influence of alcohol, drugs, or medication.
4. Always use the assist handle. See "Assembly."
5. Wear hearing protection if you use this tool for more than 1½ hours per day.
6. Never start or run the engine inside a closed room or building. Breathing exhaust fumes can kill.
7. Keep handles free of oil and fuel.

▲ TOOL SAFETY

1. Inspect the entire tool before each use. Replace damaged parts. Check for fuel leaks and make sure all fasteners are in place and securely fastened.
2. Replace trimmer head parts that are cracked, chipped, or damaged in any way before using the tool.
3. Use only WEED EATER® flexible, non-metallic, monofilament cutting line of the correct diameter. Never use wire, rope, string, etc.
4. Be sure the shield is properly attached.
5. Use only the specified WEED EATER® trimmer head. See "Specifications." Make sure the trimmer head is properly installed and fastened. See "Assembly."
6. Make carburetor adjustments with the drive shaft housing supported to prevent the trimmer line from contacting any object. Hold the tool by hand; do not use the optional shoulder strap for support.
7. Keep others away when making carburetor adjustments.
8. Use only WEED EATER® accessories as recommended for this tool by the manufacturer.

▲ FUEL SAFETY

1. Mix and pour fuel outdoors and where there are no sparks or flames.
2. Use a container approved for fuel.
3. Do not smoke or allow smoking near fuel or the tool or while using the tool.
4. Wipe up all fuel spills before starting engine.
5. Move at least 10 feet away from fueling site before starting engine.
6. Stop engine before removing fuel cap.
7. Empty the fuel tank before storing the tool.
8. Store tool and fuel in an area where fuel vapors cannot reach sparks or open flames from water heaters, electric motors or switches, furnaces, etc.

▲ CUTTING SAFETY

1. Inspect the area to be cut before each use. Remove objects (rocks, broken glass, nails, wire, string, etc.) which can be thrown or become entangled in the trimmer head.
2. Keep others including children, animals, bystanders, and helpers outside the 60 foot Hazard Zone. Stop the engine immediately if you are approached.
3. Be aware that the trimmer head will always turn when the engine is running due to the direct drive design. Keep trimmer head away from objects that can be thrown and cause injury.
4. Always keep the engine on the right side of your body.
5. Hold the tool firmly with both hands.
6. Keep firm footing and balance. Do not over-reach.
7. Keep the trimmer head below waist level.
8. Do not raise the engine above your waist. The trimmer head can come dangerously close to your body.
9. Keep all parts of your body away from the trimmer head and muffler when the engine is running.
10. Use only for jobs explained in this manual.

▲ MAINTENANCE SAFETY

1. Maintain the tool according to recommended procedures. Keep the trimmer line at the proper length.
2. Disconnect the spark plug before performing maintenance except for carburetor adjustments.
3. Make carburetor adjustments with the drive shaft housing supported to prevent the trimmer line from contacting any object. Hold the tool by hand; do not use the optional shoulder strap for support.
4. Keep others away when making carburetor adjustments.
5. Use only genuine WEED EATER® replacement parts as recommended by the manufacturer.

▲ TRANSPORTING AND STORAGE

1. Hand carry the tool with the engine stopped and the muffler away from your body.
2. Allow the engine to cool, empty the fuel tank, and secure the tool before transporting in a vehicle or storing.
3. Empty the fuel tank before storing the tool. Use up the fuel left in the carburetor by starting the engine and letting the engine run until it stops.
4. Store tool and fuel in an area where fuel vapors cannot reach sparks or open flames from water heaters, electric motors or switches, furnaces, etc.
5. Store the tool so the line limiter cannot accidentally cause injury. The tool can be hung by the bracket below the engine or by the drive shaft housing.
6. Store tool out of reach of children.

If situations occur which are not covered in this manual, use care and good judgement. Contact your dealer if you need assistance.

KNOW YOUR TRIMMER

A. INTRODUCTION

Your Trimmer is a versatile product developed for large lawns and to make short work of a variety of lawn care tasks — trimming, scalping, mowing, and sweeping.

Special Features Include:

- All-position Carburetor
- Adjustable Assist Handle
- Tap-N-Go II™ semi-automatic line feed
- 15" cutting path

B. UNPACKING INSTRUCTIONS

1. Remove contents from the carton if you have not done so.
2. Check parts against the list below.
3. Examine parts for damage. Do not use damaged parts.
4. *Notify your WEED EATER® dealer immediately if a part is missing or damaged.*

NOTE: It is normal to hear the fuel filter rattle in an empty fuel tank.

C. CARTON CONTENTS

KEY NO.		QTY.
1	Engine	1
2	Drive Shaft/Bearing Assembly w/Safety Label	1
3	Shield	1
4	Trimmer Head	1
5	Assist Handle	1
—	Operator's Manual (not shown)	1
—	Loose Parts Bag (not shown)	1

** LOOSE PARTS BAG CONTENTS:

6	Screw, Shield	2
7	Bracket-Shield	1
8	Hex Bolt, Assist Handle	1
9	Washer, Flat, Assist Handle	1
10	Wing Nut, Assist Handle	1
11	Clamp-Engine Shroud	1
12	Bolt-Engine Shroud	1
13	Nut-Engine Shroud	1

** Hardware is shown in actual size drawings in the assembly instructions. Compare the hardware in the loose parts bag with the hardware in the drawings to determine the correct part to use.

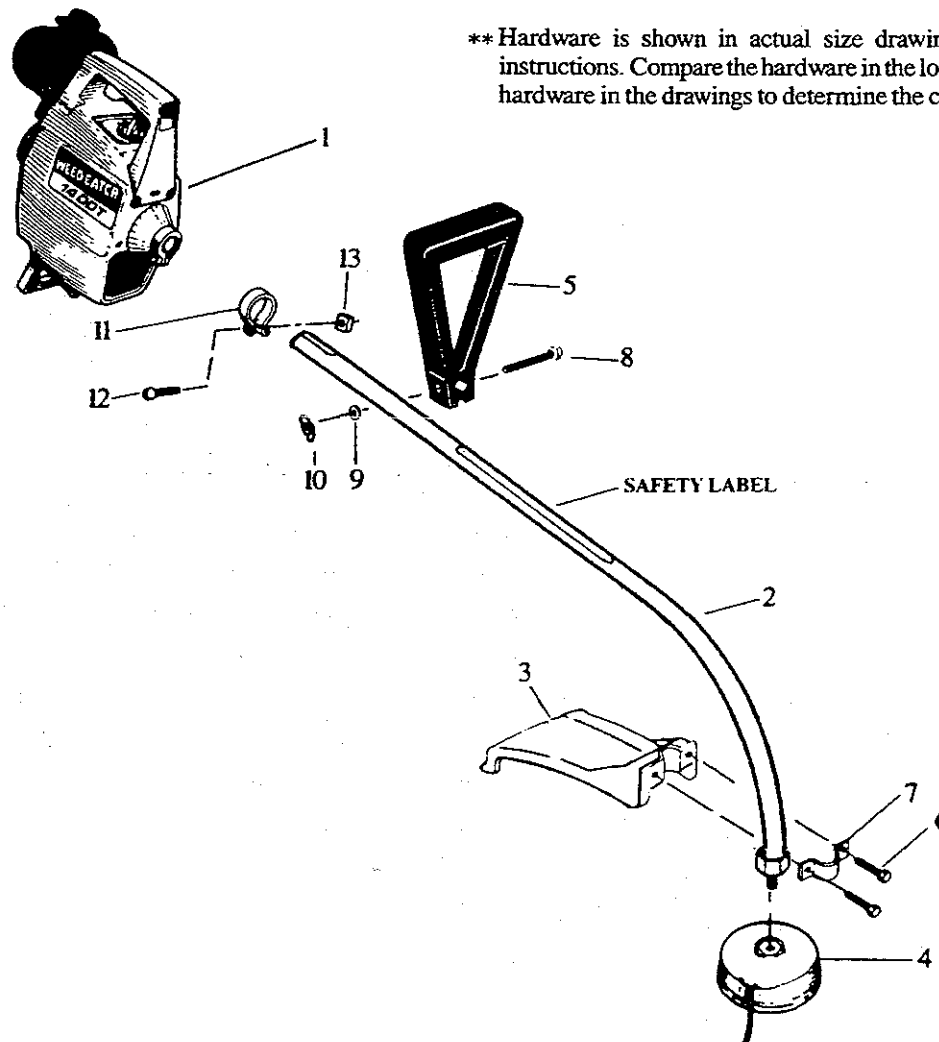

ASSEMBLY (If tool is received assembled, repeat all steps in this section to be sure assembly is correct and is adjusted for the operator.)

A. PREPARATION

This Operator's Manual has been developed to help you assemble the tool and to provide its safe operation. It is important that you read the entire manual to become familiar with the tool *before* you begin assembly.

1. READ YOUR OPERATOR'S MANUAL

B. TRIMMER ASSEMBLY STEPS

1. DRIVE SHAFT HOUSING — Figure 1

- Remove the packing cover from the end of the Drive Shaft Housing.

NOTE: Make sure the Flexible Drive Shaft does not fall out of the Drive Shaft Housing when the packing cover is removed. Dirt on the shaft will significantly reduce the life of the tool. If the Flexible Drive Shaft falls out of the housing, reinstall.

- Mark a line 1-1/2 inches from the straight end of the Drive Shaft Housing. Figure 1.
 - Place the Clamp from the loose parts bag on the Engine Shroud as shown in Figure 1.
 - Pull about 6 inches of the Flexible Drive Shaft from the straight end of the Drive Shaft Housing with needle-nose pliers.
 - Insert the end of the Flexible Drive Shaft into the square opening inside the Engine Shroud.
 - Align the keyway in the Drive Shaft Housing with the key inside the Engine Shroud opening. Figure 1.
 - Firmly push the Drive Shaft Housing into the Engine Shroud until it bottoms out, approximately at the 1-1/2" mark.
- NOTE:** The position of the Drive Shaft Housing must be as shown in Figures 1 and 5.
- Place the Nut on the tab side of the Clamp so the Nut will not turn and install the Clamp Screw.
 - Tighten the Clamp Screw securely with a screw driver.

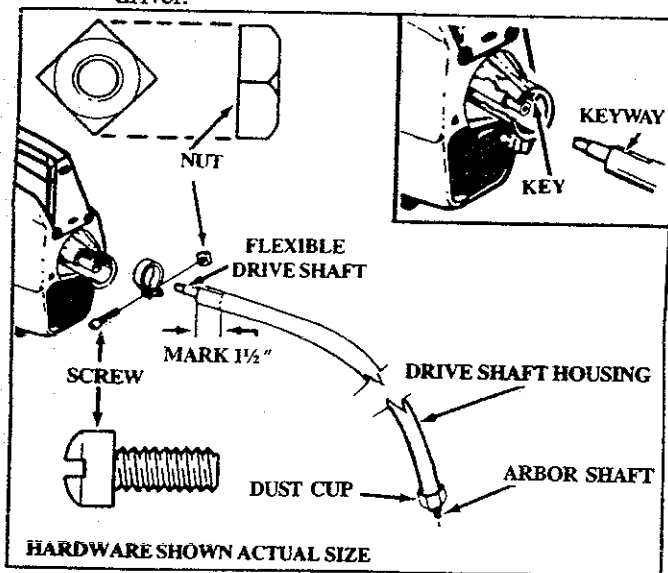

Figure 1

2. Tools you will need:

- Flathead Screwdriver
- Needle-nose Pliers
- Tape Measure & Grease Pencil
- Wrenches: 1-1/4 inch or Adjustable Wrench

2. TRIMMER HEAD — Figure 2

- Remove the packing cover from the Arbor Shaft.
- Hold the Dust Cup with a wrench to keep the Dust Cup from turning. Figure 2.
- Thread the Trimmer Head (as shown in Figure 2) onto the Arbor Shaft, against the Dust Cup, and as tight as possible with your hand.

NOTE: Unless the Trimmer Head is tightened adequately, it can unthread the first time the engine is started. If this occurs, reinstall the Trimmer Head and tighten more securely.

- Press the Tap Button and pull the Trimmer Line from the Head a minimum of 4 inches. Figure 3. Approximately 2 inches of line can be advanced each time the Tap Button is pressed.

NOTE: To remove Trimmer Head, hold the Dust Cup with a wrench and unthread the Trimmer Head.

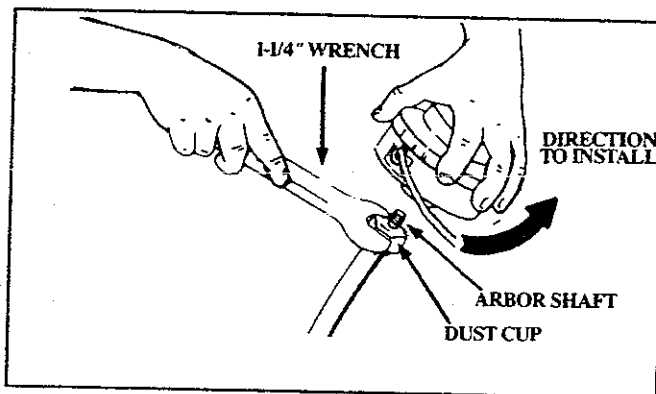

Figure 2

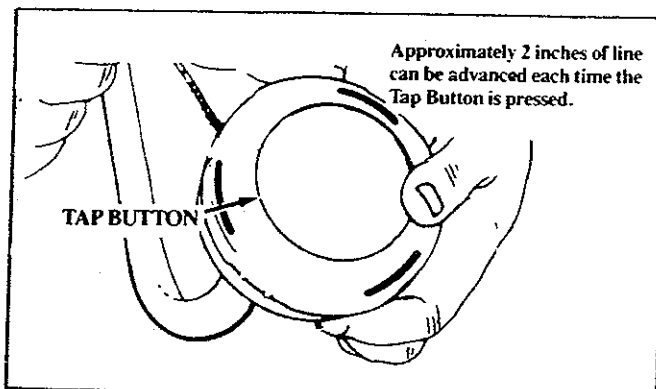

Figure 3

3. SHIELD – Figure 4

WARNING

Failure to install the shield in the position shown in Figure 4 and 5 can result in serious injury to the operator. The length of the shield must be aligned with the length of the drive shaft housing. Direct the widest part of the shield toward the engine.

CAUTION: The Line Limiter is sharp and can cut you.

- Match the Key (Raised area) on the Shield with the Keyway (“V” slot) on the Drive Shaft Housing. Figure 4(Inset).
 - Rest the bottom of the Shield on top of the shoulder located on the Drive Shaft Housing above the Dust Cup.
- NOTE:** The bottom of the Shield must rest on top of the shoulder of the Drive Shaft Housing.
- Install the Bracket and Screws as shown in Figure 4.
 - Tighten the Screws evenly and securely with a wrench.
- NOTE:** A small space may be left between the Bracket and the Shield when hardware is fully tightened.

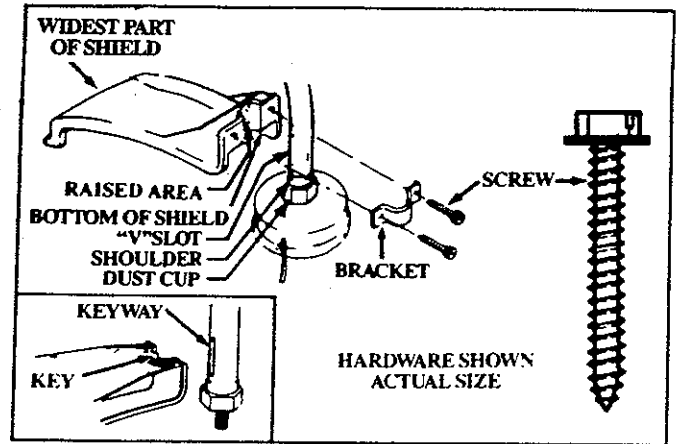

Figure 4

4. ASSIST HANDLE – Figure 5

- Hold the Assist Handle and with the hollow side facing the Engine so it is aligned between the Engine and the Safety Label on the Drive Shaft Housing. Figure 5.
- Firmly push the Assist Handle over the Drive Shaft Housing. Figure 5.
- Install the Bolt in the side of the Assist Handle with the hex opening.
- Install the Washer and Wing Nut. Figure 5.
- Tighten the Wing Nut by hand *only*:

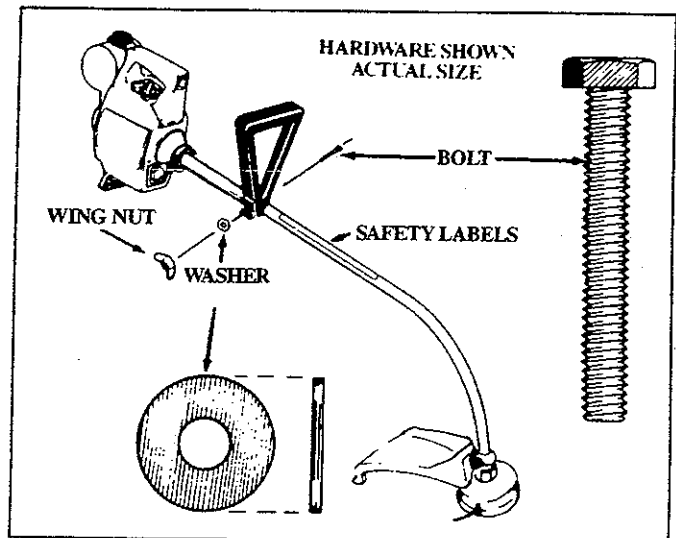

Figure 5

5. OPERATING POSITION – Figure 6

- Before starting the Engine, stand as shown in Figure 6 and check for the following:
 - Left arm fully extended, hand holding Assist Handle.
 - Right arm slightly bent, hand holding the Rear Handle, and fingers on Throttle Trigger.
 - Rear Handle below waist level.
 - Weight of tool evenly distributed between arms.
 - Without operator bending, the Trimmer Head is near and parallel to the ground and easily contacts the material to be cut.
- Adjust the Assist Handle up or down the Drive Shaft Housing (*but above the Safety Label*) to a comfortable position.
 - Loosen the Wing Nut by hand, adjust the Assist Handle. Retighten Wing Nut by hand *only*.
 - Rotate the Assist Handle from left to right if it is necessary to tilt the angle of the Trimmer Head when cutting a large, sloped area such as a ditch bank.

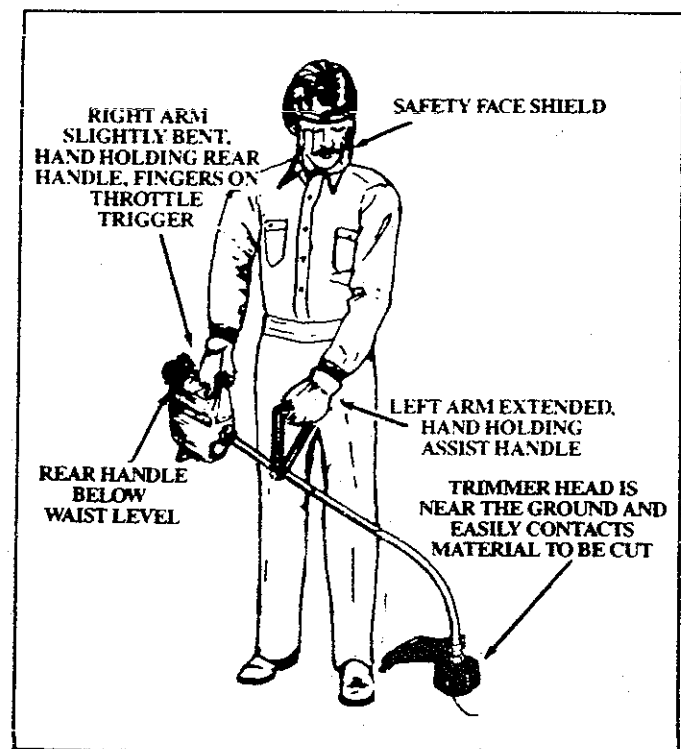

Figure 6

ENGINE INFORMATION

A. FUELING YOUR ENGINE

1. FUEL SAFETY

- a. Use only recommended fuel mixtures.
- b. Mix and pour fuel outdoors and where there is no sparks or flames.
- c. Use a container approved for fuel.
- d. Do not smoke or allow smoking near fuel or the tool or while using the tool.
- e. Wipe up all fuel spills before starting engine.
- f. Move at least 10 feet away from fueling site before starting engine.
- g. Stop engine before removing fuel cap.
- h. Empty the fuel tank before storing the tool. Use up fuel left in the carburetor by starting the engine and letting the engine run until it stops.
- i. Store tool and fuel in an area where fuel vapors cannot reach sparks or open flames from water heaters, electric motors or switches, furnaces, etc.

2. FUEL MIXTURE

- Your tool is powered by a two-cycle engine which requires a fuel mixture of regular, leaded, or unleaded gasoline and a high quality engine oil specially made for 2-cycle, air cooled engines. The internal design of the 2-cycle engine requires lubrication of moving parts. Lubrication is provided when the recommended mixture of gasoline and oil is used.
- Genuine POULAN/WEED EATER 40:1 Engine Oil is strongly recommended for the protection of your unit. Extensive engineering tests have proven that Poulan/Weed Eater oil resists breakdown at operating temperatures common to 2-cycle engines, resulting in dependable performance and longer engine life.
- Gasoline must be clean and fresh. After a short period of time, gasoline will chemically break down and form compounds that cause hard starting and damage to 2-cycle engines.
- The correct measure of gasoline to oil is very important. Too much oil in the mixture will foul the spark plug.

CAUTION: Too little oil or incorrect oil will cause the engine to overheat and seize.

- Always mix the fuel thoroughly in a container since gasoline and oil do not readily combine. *Do not mix gasoline and oil directly in the fuel tank.*

3. USE THE FOLLOWING:

Poulan Weed Eater™ 40:1 Engine Oil is strongly recommended. Available in the following convenient container sizes, Poulan Weed Eater™ 40:1 Engine Oil should be mixed as follows:

3.2 oz. Container ... Mix with 1 gallon fuel.

8 oz. Container ... Mix with 2-1/2 gallons fuel.

If none of the above oils are available, use a good quality, two-cycle, air cooled engine oil mixed at a ratio of 16:1 (8 oz. oil to 1 gallon fuel)

4. DO NOT USE:

- BIA OIL (Boating Institute of America) —
— Does not have proper additives for air-cooled 2-cycle engines and can cause engine damage.
- AUTOMOTIVE OIL —
— Does not have proper additives for 2-cycle engines and can cause damage.

5. HOW TO MIX FUEL AND FILL TANK

- a. Pour 1/2 of the gasoline to be used into an approved, marked container. *Do not mix gasoline and oil directly in the fuel tank.*
- b. Add entire measure of engine oil.
- c. Cover container tightly and shake for one minute.
- d. Add remainder of gasoline.
- e. Cover container tightly and shake again.
- f. Slowly remove fuel container cover.
- g. Remove fuel cap. See "Specifications," for location.
- h. Fill the tank using a spout or funnel.
- i. Reinstall the fuel cap securely.

B. PRE-OPERATION CHECKS

⚠ WARNING

Review all Warnings and Safety Instructions in this manual.

Before operating your tool, always:

1. Inspect the entire tool before each use. Replace damaged parts. Check for fuel leaks and make sure all fasteners are in place and securely fastened.
2. Replace trimmer head parts that are cracked, chipped, or damaged before using this tool.
3. Use only WEED EATER® flexible, non-metallic, monofilament trimming line of the correct diameter. Never use wire or rope, string, etc.
4. Use only with the shield properly attached.

5. Use only the specified WEED EATER® trimmer head. See "Specifications." Make sure the trimmer head is properly installed and securely fastened. See "Assembly."
6. Make carburetor adjustments with the drive shaft housing supported to prevent the trimmer line from contacting any object. Hold the tool by hand; do not use the optional shoulder strap for support.
7. Keep others away when making carburetor adjustments.
8. Use only WEED EATER® accessories as recommended for this tool by the manufacturer.
9. Clean the air filter if dirty before operating the tool. Refer to "Specifications" for air filter location.

C. STARTING INSTRUCTIONS (For location of controls, refer to "Specifications.")

1. Before starting the engine:

- a. Fuel engine. Move 10 feet away from fueling site.
- b. Extend line 4-6 inches from Trimmer Head to provide adequate load on engine. Figure 3.

⚠ WARNING

The trimmer head will turn as soon as engine starts.

- c. Rest engine and Shield on ground, supporting Trimmer Head off ground away from trees, bushes, onlookers, etc. Figure 7.
- d. With optional Shoulder Strap, place Shoulder Strap on your shoulder. Start engine before lifting tool to operating position or clipping Shoulder Strap to tool.

2. For a Cold Engine:

- a. Move Choke to "On" position. Figure 8.
- b. Grip rear handle and keep Throttle Trigger fully squeezed through step "f."
- c. Pull Starter Rope sharply until engine attempts to run, but no more than 8 pulls at full choke to avoid flooding the engine. *The engine "attempt to run" may be hard to hear. The operator must listen carefully.* After 8 pulls, proceed to step "d." even if engine has not attempted to run.
- d. Move Choke to "half" position. Figure 8.
- e. Pull Starter Rope sharply until engine runs, but no more than 5 pulls.

NOTE: If engine has not started after 5 pulls, repeat steps "a" through "e."

- f. Allow engine to run 5 seconds, then push Choke to "off" position. Figure 8. *Keep Trigger fully squeezed until engine runs smoothly.*

NOTE: If engine dies with Choke at "off" position, repeat steps "d" through "f."

⚠ WARNING

Avoid any bodily contact with the muffler when starting a warm engine. A hot muffler can cause serious burns.

3. For A Warm Engine:

- a. Move Choke to "half" position. Figure 8.
- b. Grip rear handle and keep Throttle Trigger fully squeezed until engine runs.
- c. Pull Starter Rope sharply until engine runs, but no more than 5 pulls.
- d. Move Choke to "off" position. Figure 8. *Keep Trigger fully squeezed until engine runs smoothly.*

NOTE: If engine does not run after 5 pulls, it is probably flooded. Wait a few minutes and repeat procedure with Choke at "off" position. Figure 8.

4. For A Warm Engine (After Running Out of Fuel;)

- a. Refuel engine. Move 10 feet away from fueling site.
- b. Move Choke to "On" position. Figure 8.
- c. Grip rear handle and keep Throttle Trigger fully squeezed until engine runs.
- d. Pull Starter Rope sharply until engine attempts to run, but no more than 5 pulls.
- e. Move Choke to "off" position. Figure 8.
- f. Pull Starter Rope until engine runs, but no more than 5 pulls. *Keep Trigger fully squeezed until engine runs smoothly.*

NOTE: If engine has not started, pull Starter Rope 5 more pulls. If engine still does not run, it is probably flooded. Wait a few minutes and repeat procedure with Choke at "off" position. Figure 8.



Figure 7

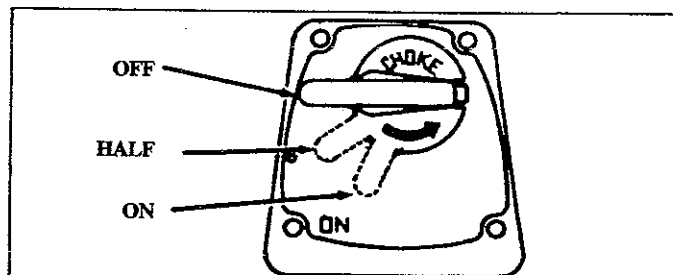

Figure 8

D. OPERATING INSTRUCTIONS

1. Bring the engine to cutting speed before entering the material to be cut.

a. Do not run the engine at a higher speed than necessary. The cutting line will cut efficiently when the engine is run at less than full throttle. At lower speeds there is less engine noise and vibration. The trimmer line will last longer and will be less likely to "weld" onto the spool.

b. If the Trimmer Head does not turn when the engine is accelerated, make sure the Drive Shaft Housing is properly seated in the Engine Shroud. Refer to "Assembly-Drive Shaft Housing."

2. To stop the engine:

a. Release the Throttle Trigger.

b. Push "Off" Button. *Hold button down until the engine stops. Figure 9.*

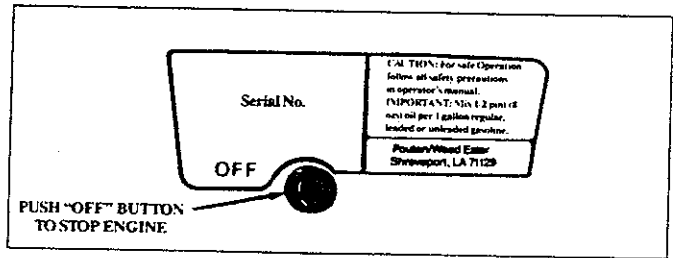
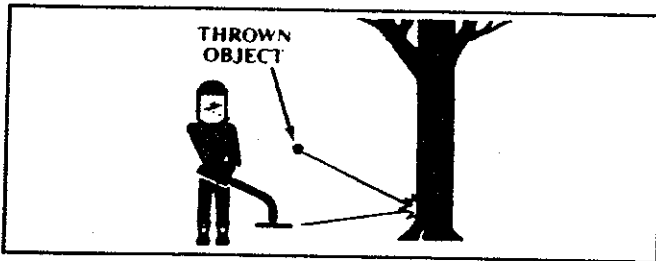

Figure 9

USING YOUR TRIMMER



⚠ WARNING — THROWS OBJECTS

The rapidly moving line causes objects to be thrown violently. The shield will not provide complete protection to the operator or others. The operator must wear a safety face shield or goggles. Always wear heavy, long pants and boots. Keep others at least 30 feet away.

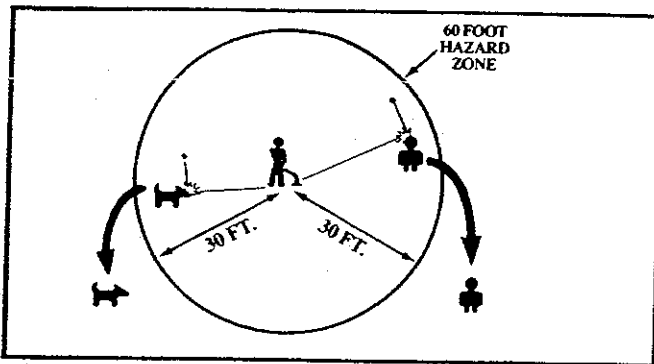

⚠ WARNING — HAZARD ZONE

This tool will throw objects and cut. Keep others including children, animals, bystanders, and helpers at least 30 feet away from the operator and tool. Stop the engine if you are approached.

⚠ WARNING — DAMAGED TRIMMER HEAD

Trimmer head parts that are chipped, cracked, or damaged in any way can fly apart and cause serious injury. Do not use. Throw damaged parts away. Replace damaged parts before using the tool.



Tap-N-Go II™ Trimmer Head
#952-701604
Use Only Genuine Weed Eater® Parts

A. LINE TRIMMER SAFETY

1. OPERATOR

- a. Always wear a safety face shield or goggles. See "Accessories."
- b. Always wear heavy, long pants, boots, and gloves. Do not go barefoot or wear loose clothing, jewelry, short pants, or sandals. Secure hair so it is above shoulder length.
- c. Do not operate this tool when you are tired, ill, or under the influence of alcohol, drugs, or medication.
- d. Do not swing the tool with such force that you are in danger of losing your balance.
- e. Never start or run the engine inside a closed room or building. Breathing exhaust fumes can kill.
- f. Keep handles free of oil and fuel.
- e. Make carburetor adjustments with the drive shaft housing supported to prevent the trimmer line from contacting any object. Hold the tool with your hand; do not use the optional shoulder strap for support.
- f. Keep others away when making carburetor adjustments.
- g. Use only WEED EATER® accessories as recommended for this tool by the manufacturer.

2. TOOL

- a. Inspect the entire tool before each use. Replace damaged parts. Check for fuel leaks and make sure all fasteners are in place and securely fastened.
- b. Use only WEED EATER® flexible, non-metallic, monofilament cutting line of the correct diameter. Never use wire, string, rope, etc.
- c. Be sure the shield is properly attached.
- d. Make sure the trimmer head is properly installed and securely fastened. Refer to "Assembly."

3. CUTTING

- a. Inspect the area to be cut before each use. Remove objects (rocks, broken glass, nails, wire, string, etc.) which can be thrown or become entangled in the trimmer head.
- b. Be aware that the trimmer head will always turn when the engine is running due to the direct drive design. Keep trimmer head away from objects that can be thrown and cause injury.
- c. Always keep the engine on the right side of your body.
- d. Hold the tool firmly with both hands.
- e. Keep firm footing and balance. Do not over-reach.
- f. Keep the trimmer head below waist level.
- g. Do not raise the engine above your waist.
- h. Keep all parts of your body away from the trimmer line and muffler when the engine is running.
- i. Use only for jobs explained in this manual.

B. TRIMMER LINE ADVANCE

- The line will advance approximately 2 inches each time the bottom of the trimmer head is tapped on the ground with the engine running at full throttle.
- The most efficient line length is the maximum length allowed by the line limiter.
- Always keep the shield in place when the tool is being operated.
- To advance line:
 1. Operate the engine at full throttle.
 2. Hold trimmer head parallel to and above the grassy area.
 3. Tap the bottom of the trimmer head lightly on the ground one time. See Figure 10. Approximately 2 inches of line will be advanced with each tap.

NOTE: If the line is worn down to two inches or less, more than one tap will be required to obtain the most efficient line length.

⚠ WARNING

Use only .080" diameter Weed Eater® Trimmer Line. Do not use other materials such as rope, wire, string, etc. Wire can break off during cutting and become a dangerous missile.

NOTE: Always tap the trimmer head on a grassy area. Tapping on surfaces such as concrete or asphalt can cause excessive wear to the trimmer head.

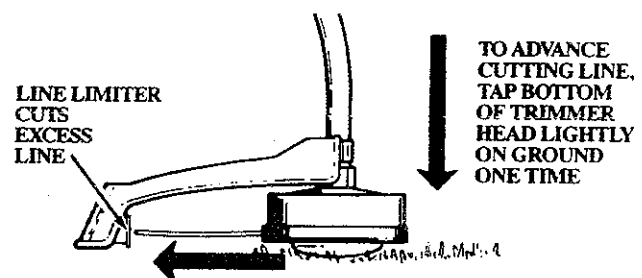

Figure 10

C. CUTTING METHODS

- The tip of the line does the cutting. Allow the line to trim at its own pace. You will achieve better results by not crowding the line into the cutting area. The right and wrong way are shown in Figure 11.
- The line will easily remove grass and weeds from around walls, fences, trees, and flower beds, *but it also can cut the tender bark of trees or shrubs and scar fences.* To help avoid damage to vegetation or trees with tender bark, shorten line to 4-5 inches and use less than full throttle.
- The line will wear faster and will need to be advanced more frequently when you are cutting against rocks, bricks, concrete, metal fences, etc., than when cutting against trees or wooden fences.
- For trimming or scalping, use less than full throttle to increase line life and decrease head wear:
 - during light duty cutting.
 - next to rocks, bricks, concrete, metal fences, etc.
- For mowing or sweeping, use full throttle for a good clean job.
- Avoid letting the trimmer head continuously contact the ground during normal cutting. Constant contact will cause trimmer head damage and premature wear.

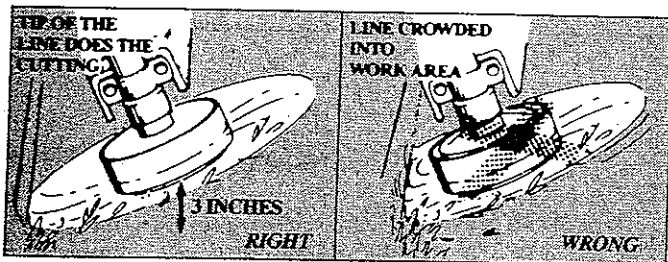

Figure 11

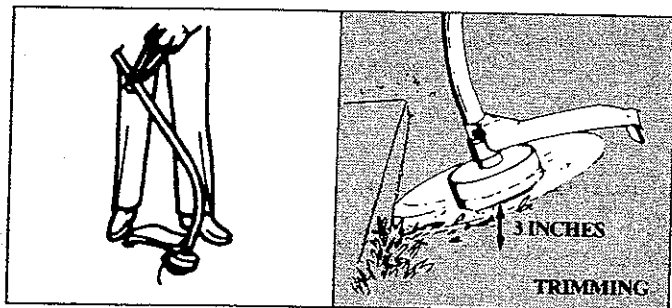

Figure 12

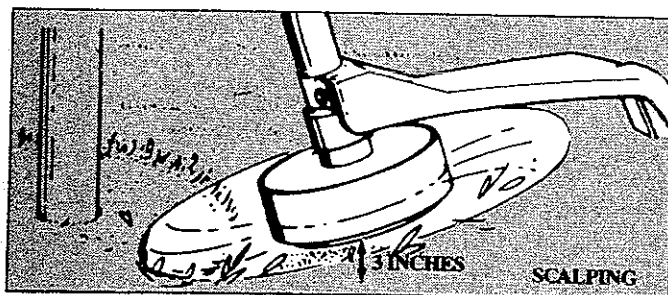

Figure 13

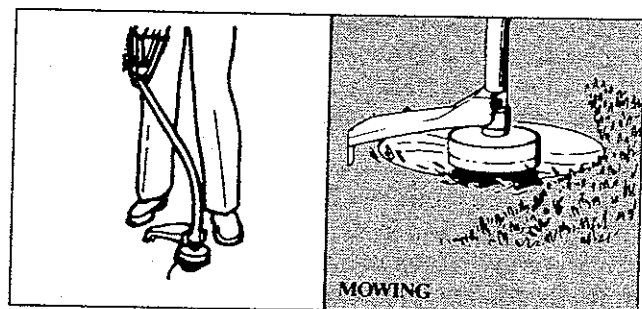

Figure 14

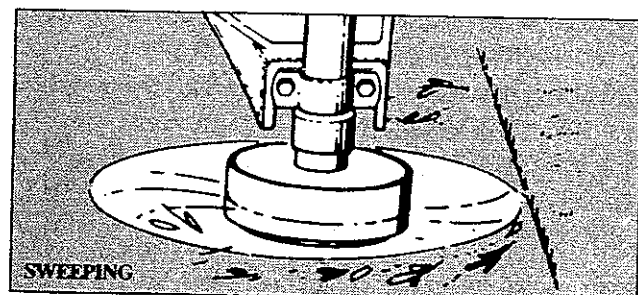

Figure 15

⚠ WARNING

Always wear eye protection. Never lean over the trimmer head. Rocks or debris can ricochet or be thrown into eyes and face and cause blindness or other serious injury.

1. TRIMMING – Figure 12

Hold the tap button about 3 inches above the ground and tilt the trimmer head at an angle. Allow the tip of the line to do the cutting. Do not force the trimmer line into the work area. The direct drive design of the engine allows the trimmer head to turn when the engine is idling. This speed is good for slow, controlled trimming around tender plants.

2. SCALPING – Figure 13

The scalping technique removes unwanted vegetation. Hold the tap button about 3 inches above the ground and tilt the trimmer head at an angle. Allow the tip of the line to strike the ground around trees, posts, monuments, etc. *This technique increases line wear.*

3. MOWING – Figure 14

Your trimmer is ideal for mowing in places conventional lawn mowers cannot reach. In the mowing position, keep the line parallel to the ground. Avoid pressing the head into the ground as this can scalp the ground and damage the tool.

4. SWEEPING – Figure 15

The fanning action of the rotating line can be used for a quick and easy clean up. Keep the line parallel to and above the surfaces being swept and move the tool from side to side.

D. LINE REPLACEMENT

● For proper line feed:

- Use only genuine Weed Eater® pre-wound spools and bulk line. Use of other spools or line can result in excessive breakage, line welding, and improper line feed.
- Pre-wound spools offer the most convenient method for replacing line as well as optimum performance.

- Always clean dirt and debris from the spool and hub when performing any type maintenance.

1. Installing Spool w/Line

- Hold the Trimmer Head as shown in Figure 16. Press the Lock Tab and turn Cover counterclockwise.
- Remove the Lock Ring and Spool. Figure 17.
- Clean dirt and debris from all parts. Inspect all Trimmer Head parts for damage. Replace damaged parts.

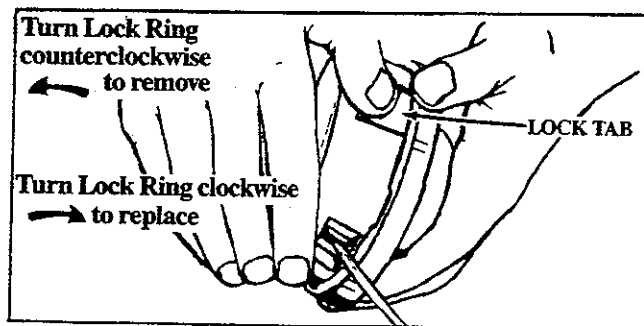

Figure 16

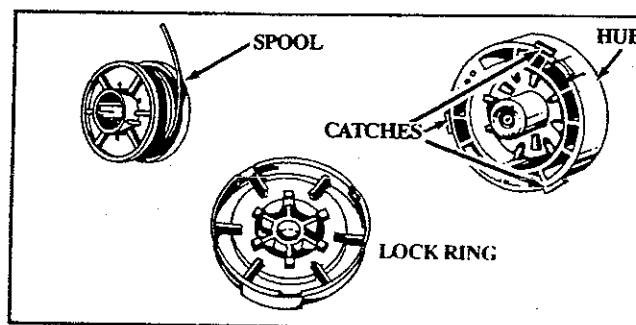

Figure 17

⚠ WARNING
Trimmer head parts that are chipped, cracked, or damaged in any way can fly apart and cause serious injury. Do not use. Replace damaged parts before using the tool.

- Insert the end of the Line in the Line Exit Hole as shown in Figure 18. Place Spool in Hub. Make sure the Trimmer Line is not caught between the rim of the Spool and the Hub.
- Align the Lock Ring over the three Catches on the Hub. Push the Lock Ring down on the Hub and turn clockwise. Figures 16 and 17.
- Check to make sure all three Catches and the Lock Tab are properly fastened (as shown in Figure 19) by attempting to turn the Lock Ring counterclockwise and pulling on it. Then test the Lock Ring by trying to turn it counterclockwise.

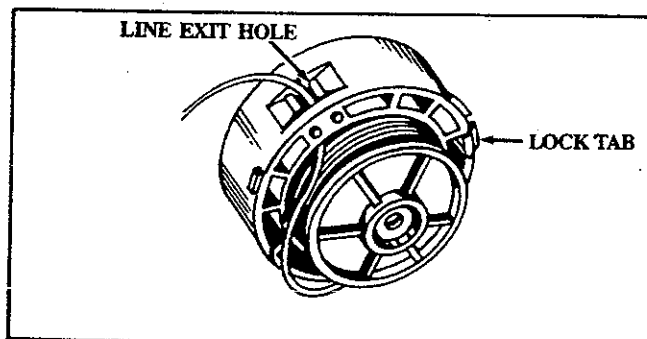

Figure 18

⚠ WARNING
All three catches must be fastened and the lock tab latched on to the lock ring. If installed incorrectly, the lock ring can fly off and become a dangerous missile.

- Pull on the Line to change the Spool from the locked position to the operating position. Figure 20.
- Obtain correct line length by pressing Tap Button and pulling on the Line again.

NOTE: Each time the Tap Button is pressed, approximately 2 inches of line can be pulled from the Trimmer Head. Figure 20.

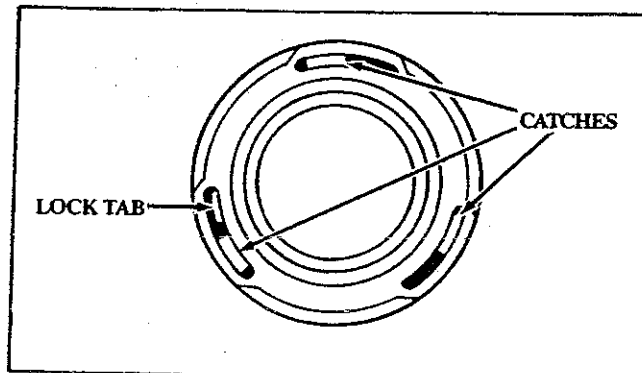

Figure 19

2. Installing Line on Spool

To replace the Line on existing spool:

- 1). Follow "Installing Spool w/Line," steps "a-c." and remove any Line remaining on the spool.
 - 2). Use a 40 foot length of Weed Eater .080" diameter trimmer Line.
 - 3). Insert 1/16 to 1/8 inch of the end of the Line through the hole in the inner rim of the Spool. Figure 21. Allow no more than 1/8 inch of Line to extend beyond the rim to avoid interference with the tapping action.
 - 4). Wrap the Line firmly and evenly onto Spool in a clockwise direction as shown by arrow on Spool. Figure 21.
- NOTE:** The Line must be wrapped firmly and evenly for proper line feed.
- 5). Follow "Installing Spool w/Line, steps "d-h."
- b. If the Line breaks off or backs up in the Trimmer Head, follow "Installing Spool w/Line," steps "a-c." Pull slack in Line until the Line is tightly wound on Spool, leaving 4-6 inches of extended Line. Continue with steps "d-h."

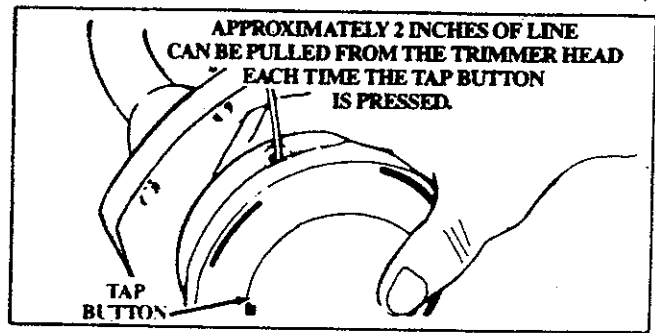

Figure 20

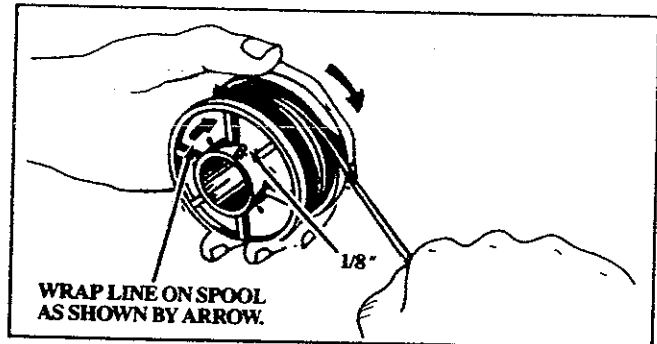

Figure 21

GENERAL MAINTENANCE

A. MAINTENANCE SAFETY

1. Maintain the tool according to recommended procedures. Keep the trimmer line at the proper length.
2. Disconnect the spark plug before performing maintenance except for carburetor adjustments.
3. Make carburetor adjustments with the drive shaft housing supported to prevent the trimmer line from contacting any object. Hold the tool with your hand; do not use the optional shoulder strap for support.
4. Keep others away when making carburetor adjustments.
5. Use only WEED EATER® flexible, non-metallic monofilament cutting line of the correct diameter. Never use wire, rope, string, etc.
6. Replace trimmer head parts that are cracked, chipped, or damaged in any way before using the tool.
7. Use only genuine WEED EATER® replacement parts as recommended by the manufacturer.
8. Inspect entire tool. Replace damaged parts. Check for fuel leaks. Make sure all fasteners are in place and securely fastened.

B. STARTER ROPE

- **This is a complicated and potentially hazardous task. It is recommended that only a qualified service dealer perform this repair.**

⚠ WARNING

Always wear eye protection and gloves when servicing the starter rope. The recoil spring, located beneath the pulley, is under tension. If the spring flies out, serious injury can result.

● To repair or replace:

1. Disconnect spark plug wire.
2. Drain all fuel from tank.
3. Remove the two screws and two washers from the fuel tank. Figure 22. Set fuel tank aside.
4. Remove the five screws from fan housing. Figure 23.
5. Separate fan housing from shroud about 2 inches.
6. Slide high tension lead grommet from slot in fan housing. Figure 24.
7. Separate fuel line leaving the connector in the end attached to the fuel tank. Figure 24.
8. Separate the fan housing completely from the shroud. Figure 24.
9. If the starter rope is not broken, release the spring tension by pulling about 12 inches of rope from the pulley and catch the rope in the notch as shown. Figure 28.

CAUTION: Be sure the tension on the starter spring is released by rotating the pulley clockwise → with your finger while pushing down on the pulley with your hand.

10. Remove screw from the starter pulley very carefully. Rotate the pulley clockwise → until no spring tension is felt and carefully lift the pulley out of the fan housing. Figure 27. Remove the old rope.
11. Move away from the fuel tank with the rope to be installed. Use a match and melt both ends of the rope to prevent fraying.
12. Pull the melted ends through a thick, clean rag while the rope is still hot to obtain smooth, pointed tips.
13. Insert one end of the rope through the handle and secure with a knot.
14. Insert the free end of rope through rope exit hole to the inside of the fan housing.
15. Guide rope inside pulley, then up through the pulley ratchet side of pulley hole to the outside by pushing the rope through from the hole on the spring cam side with a small Phillips screwdriver. Figure 25.
16. Wrap rope counterclockwise ← around pulley ratchet and tuck loose end back under rope where it comes out of hole. Leave a 1/4 to 1/2 inch tail laying flat on the top of the pulley alongside the retainer rib and between the rib and post. The rope tail *must not* extend beyond the edge of the pulley. Figure 26.
17. Carefully replace pulley in the housing. Be sure the pulley is all the way down. Replace washer and screw and tighten. Figure 27.

18. Turn the pulley clockwise → until all the rope is wrapped onto the pulley.
19. Pull out the rope by the handle (approximately 12") and hold the pulley.
20. Pull the 12 inch slack in the rope into the inside of the fan housing and catch rope in pulley notch. Figure 28.
21. Hold the rope taut and make 2 complete turns of the pulley counterclockwise ← to place tension on the spring. Continue to hold the pulley to retain tension.
22. Align pulley notch with rope exit hole, release slack in the rope, and pull starter handle to the full extent of the rope. Release the pulley and slowly allow the rope to wind around the pulley.
23. Reverse procedure for re-assembly of fan housing to shroud.

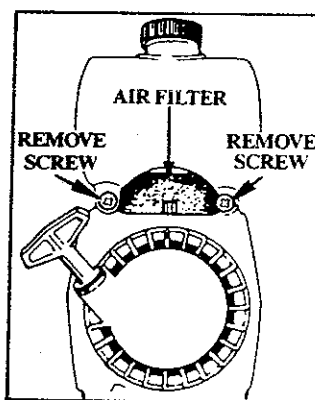

Figure 22

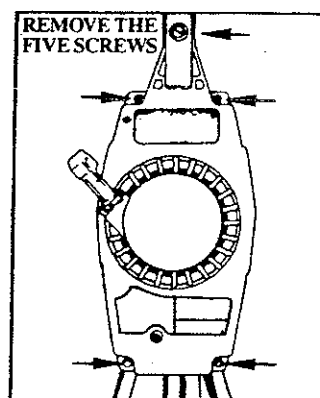

Figure 23

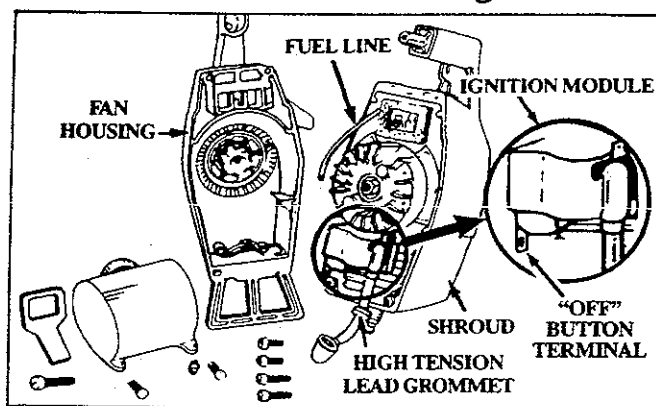

Figure 24

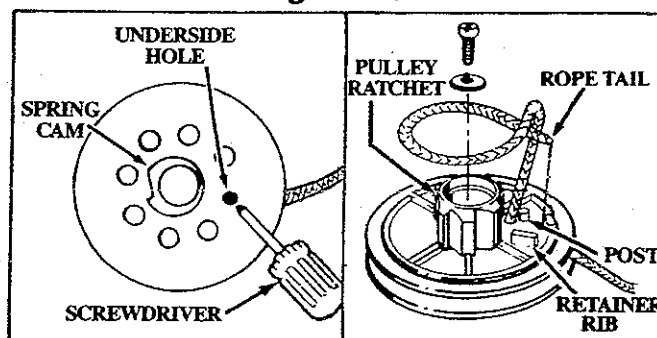

Figure 25

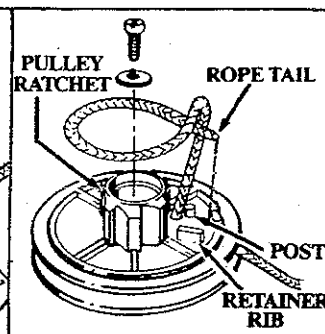

Figure 26

CAUTION: Before replacing the fan housing, make certain that the "off" button terminal on the ignition module is not bent. See insert, Figure 24.

24. Position the "off" button terminal as shown. Figure 24.
25. Make certain the engine will stop after re-assembly is completed. Start engine, press the "off" button.
26. If the engine will not stop, move choke to the "On" position (Figure 8) to stop engine. Disassemble fan housing and be sure the "off" button terminal (Figure 24) is in the correct position. Reassemble parts.

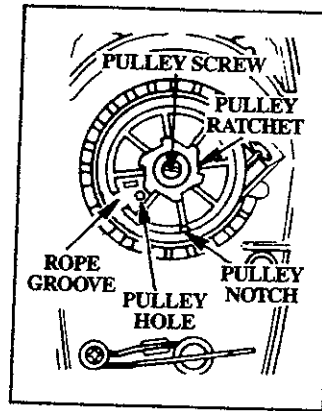

Figure 27

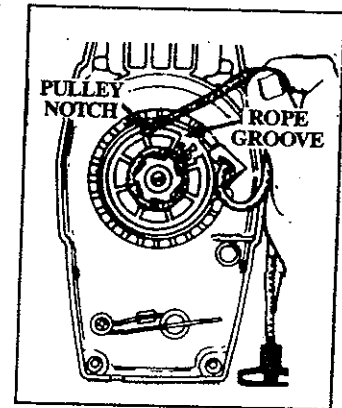

Figure 28

C. FLEXIBLE DRIVE SHAFT LUBRICATION

- Lubricate the Flexible Drive Shaft:
 - After each ten (10) hours of operation.
 - Before operating if the unit has been stored for 90 days or longer.
- Use WEED EATER® Flex Shaft Lube Part No. 530-030102.
- Use the following procedure for best results:

WARNING

If engine has just been operated, avoid touching the muffler. A hot muffler can cause serious burns.

CAUTION: Lay the Flexible Drive Shaft on a clean surface. Avoid laying the shaft on the floor, ground or on any surface that may have dirt or debris. Even after wiping the shaft, grease residue can pick up dirt particles that can cause damage or premature failure.

CAUTION: Take care to avoid injuring your hands and fingers with broken wires when checking for damage or wiping the flexible drive shaft. A cloth will not prevent the broken wires from puncturing or tearing your skin.

1. Loosen (but do not remove) the Clamp Screw and remove the Drive Shaft Housing from the Engine Shroud. Figure 1.
2. Remove the Flexible Drive Shaft from the Drive Shaft Housing as shown in Figure 29.
3. Check the Flexible Drive Shaft for broken wires, twists, or kinks and replace if damage is found.
4. Using a clean cloth, wipe the surface of the Flexible Drive Shaft thoroughly to remove any old grease. Figure 30.
5. Apply a uniform coat of lube to the entire surface of the Flexible Drive Shaft.
6. Inject the remaining contents of the tube into the top of the Drive Shaft Housing.
7. Replace Flexible Drive Shaft in the Drive Shaft Housing.
8. Follow the instructions in "Assembly" to replace Drive Shaft Housing into the Engine Shroud.

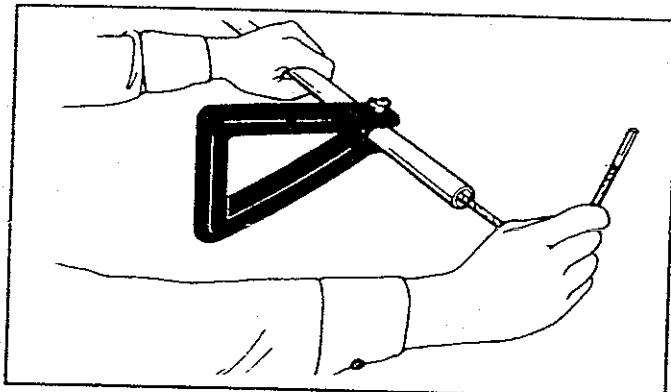

Figure 29

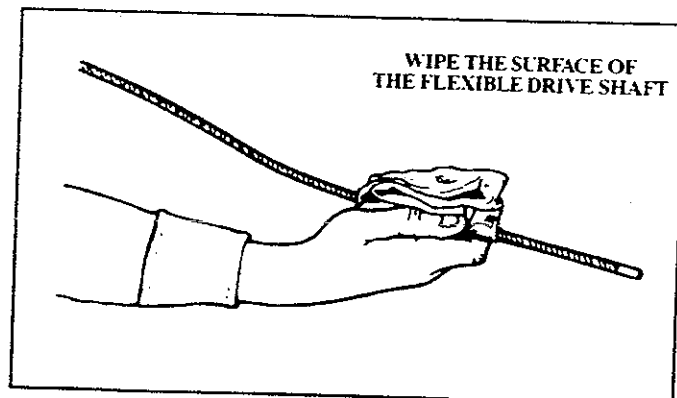

Figure 30

D. CARBURETOR ADJUSTMENTS

⚠ WARNING

Make carburetor adjustments with the drive shaft housing supported to prevent the trimmer line from contacting any object. Hold the tool with your hand; do not use the optional shoulder strap for support.

⚠ WARNING

Keep others away when making carburetor adjustments.

- If you choose to adjust the carburetor yourself, it is recommended for best results to wait until you have run at least one full tank of fuel. Then, very carefully, follow the procedure below.
- This is a complicated task and it is important to follow instructions in sequence as indicated.
- Very small adjustments can affect engine performance. It is important to turn the screws a very small amount before making further adjustments. Each adjustment should be no more than the width of the slot in the adjusting screws.

⚠ WARNING

The trimmer line will be spinning during this procedure. Wear your protective equipment and observe all safety instructions.

1. PREPARATION

- Use a fresh fuel mix. See "Fueling Your Engine."
- Make sure the line extends to the length allowed by the line limiter to provide correct load on engine.
- Start the engine. Cut grass for 3 minutes to warm engine. *The engine must be at operating temperature before carburetor adjustments can be performed correctly.*
- Stop engine and remove air filter by pulling it out with your fingers. Refer to "Specifications" for location.
- Turn Mixture Screw (Figure 31) clockwise \rightarrow until fully closed, but do not overtighten to avoid damaging the needle seats. Open Mixture Screw one and one-eighth (1-1/8) turn counterclockwise \leftarrow .
- Turn Idle Speed Screw (Figure 31) clockwise \rightarrow until it stops. Open Idle Speed Screw five (5) full turns counterclockwise \leftarrow .

E. AIR FILTER

A dirty air filter decreases the life and performance of the engine and increases fuel consumption.

Clean the Air Filter:

- Always after 5 tanks of fuel or 5 hours of operation, whichever is less.
- More frequently in dusty conditions.

2. Mixture Adjustment

CAUTION: Do not operate engine at full throttle for prolonged periods while making mixture screw adjustments as damage to the engine can occur.

- Support the drive shaft housing so that the trimmer head is off the ground and the line will not contact any object.
- Start the engine and run it at full throttle.
- Turn the Mixture Screw slowly clockwise \rightarrow until speed is reduced. Do not dwell at this position, but immediately turn screw slowly counterclockwise \leftarrow until the engine just begins to run roughly. Continue with "Idle Adjustment."

3. Idle Adjustment

- Allow engine to run at idle for about 30 seconds or until engine RPM stabilizes.
- Adjust the Idle Speed Screw until the engine idles without stalling.
 - Turn screw clockwise \rightarrow if engine stalls.
 - Turn screw counterclockwise \leftarrow to slow engine down.

4. Check Acceleration

Allow engine to idle, then squeeze trigger. If engine does not accelerate smoothly, readjust the Mixture Screw a small amount counterclockwise \leftarrow until the engine accelerates smoothly.

CAUTION: If the engine does not operate according to these instructions after repeating the adjusting steps, do not use the tool. Take it to a qualified service dealer.

5. REINSTALL AIR FILTER

Be sure filter is clean. See "Air Filter" for instructions.

CAUTION: Fit air filter into the corners of the housing to keep dirt from entering the engine and causing engine damage.

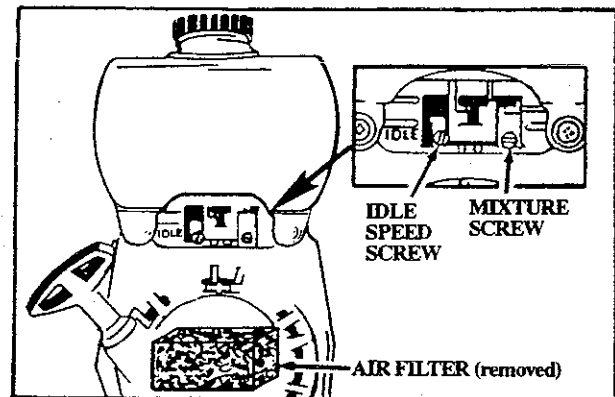

Figure 31

- Pull the Air Filter from the engine with your fingers. For Air Filter location, see "Specifications."
- Wash in soap and water.

CAUTION: Do not clean the air filter in gasoline or other flammable solvent to avoid creating a fire hazard.

- Squeeze dry and replace.

CAUTION: The air filter must be fitted into the corners of the housing to avoid engine damage.

F. TROUBLE SHOOTING CHART

SYMPTOM	CAUSE	REMEDY
Engine will not start or will run only for a few seconds after starting	<ol style="list-style-type: none"> 1. Fuel tank empty. 2. Engine flooded. 3. Spark plug not firing. 4. Fuel not reaching carburetor. 5. Carburetor requires adjustment. 6. None of the above. 	<ol style="list-style-type: none"> 1. Fill tank with correct fuel mixture. 2. See "Starting Instructions." 3. Install new plug/check ignition system. 4. Clean fuel filter, inspect fuel line. 5. See "Carburetor Adjustments." 6. Contact a qualified service dealer.
Engine will not idle properly	<ol style="list-style-type: none"> 1. Idle speed set too fast or too slow. 2. Low speed mixture requires adjustment. 3. Throttle trigger screw too tight. 4. None of the above. 	<ol style="list-style-type: none"> 1. See "Carburetor Adjustments." 2. See "Carburetor Adjustments." 3. Loosen screw to free trigger. 4. Contact a qualified service dealer.
Engine will not accelerate, lacks power, or dies under a load	<ol style="list-style-type: none"> 1. Air filter dirty. 2. Spark plug fouled. 3. Carburetor requires adjustment. 4. Muffler outlets plugged. 5. None of the above. 	<ol style="list-style-type: none"> 1. Clean or replace air filter. 2. Clean or replace spark plug and regap. 3. See "Carburetor Adjustments." 4. Contact a qualified service dealer. 5. Contact a qualified service dealer.
Engine smokes excessively	<ol style="list-style-type: none"> 1. Air filter dirty. 2. Fuel mixture incorrect. 3. High speed mixture requires adjustment. 	<ol style="list-style-type: none"> 1. Clean or replace air filter. 2. Refuel with correct fuel mixture. 3. See "Carburetor Adjustments."
Engine runs hot	<ol style="list-style-type: none"> 1. Fuel mixture incorrect. 2. High speed mixture set too low (lean). 3. Spark plug incorrect. 4. None of the above. 	<ol style="list-style-type: none"> 1. See "Fueling Your Unit." 2. See "Carburetor Adjustments." 3. Replace with correct plug. 4. Contact a qualified service dealer.
Trimmer head stops under a load or does not turn when engine is accelerated.	<ol style="list-style-type: none"> 1. Drive shaft broken or not engaged. 2. Carburetor requires adjustments. 	<ol style="list-style-type: none"> 1. Replace or see "Assembly." 2. See "Carburetor Adjustments."
Line does not advance or breaks while cutting	<ol style="list-style-type: none"> 1. Line caught between spool and hub. 2. Line improperly wound onto spool. 	<ol style="list-style-type: none"> 1. Remove cover. Check line routing. 2. Rewind spool firmly and evenly.
Excessive line usage	<ol style="list-style-type: none"> 1. Improper line size. 2. Cutting at high speed around hard objects. 3. Crowding line against material being cut. 	<ol style="list-style-type: none"> 1. Use only .080" diameter line. 2. Reduce cutting speed around hard objects. 3. Cut with tip of line.

WEED EATER® ACCESSORIES

ITEM	STOCK NO.	ITEM	STOCK NO.
SAFETY FACE SHIELD	952-701601	2-CYCLE ENGINE OIL	
SAFETY GOGGLES	952-062003	— 8 OZ. (16:1)	952-003039
SAFETY LEG GUARDS	952-701600	— 8 OZ. (32:1)	952-030117
NYLON CUTTING LINE		— 4 OZ. (32:1)	952-030119
(.080" diameter - 80' long)	952-701534	FUEL CAP	952-701583
SPOOL W/LINE	952-701606	AIR FILTER	952-701568
TAP-NO-GO II™ TRIMMER HEAD	952-701604	SPARK PLUG	952-030077
FLEX SHAFT LUBE	952-701570	MUFFLER GUARD KIT	952-069262
SHOULDER STRAP	952-701548	ILLUSTRATED PARTS LIST	530-066427
SPARK ARRESTOR KIT	952-701612	OPERATOR'S MANUAL	530-067065

PARTS AND SERVICE

Your Poulan /Weed Eater product has been expertly engineered and carefully manufactured to rigid quality standards. As with all mechanical products, some adjustments or part replacement may be necessary during the life of your unit.

FOR SERVICE OR REPLACEMENT PARTS:

1. Consult the yellow pages of your phone directory for the name of the nearest Poulan/Weed Eater Master Service Dealer (under "saws" for Chain Saws or under "lawnmowers" for trimmers, Brushcutters, and Blowers) or Skil Service Center (under "tools-electric").
2. For replacement parts have available the following information:
 - a. Description of the unit.
 - b. Model number.
 - c. Part Number or description of part.

NOTE: Poulan/Weed Eater Division provides parts and service through its authorized distributors and dealers; therefore, all requests for parts and service should be directed to your local dealer(s). The philosophy of Poulan/Weed Eater Division is to continually improve all of its products. Written notices of changes and improvements are sent to authorized Poulan/Weed Eater Dealers. If the operating characteristics or the appearance of your product differs from those described in this Operator's Manual, please contact your local Poulan/Weed Eater Dealer for updated information and assistance. Always update your tool when improvements are made available, especially those related to safety. Parts and repair service are not available directly from Poulan/Weed Eater Division White Consolidated Industries, Inc..

POULAN/WEED EATER
DIVISION WHITE CONSOLIDATED INDUSTRIES, INC.
Shreveport, Louisiana 71139-9329

©1988 Poulan/Weed Eater Division White Consolidated Industries, Inc.