

## Table of Contents

<b>Introduction</b>	<b>4</b>
<b>Instrument Cluster</b>	<b>10</b>
Warning lights and chimes	10
Gauges	16
<b>Entertainment Systems</b>	<b>19</b>
AM/FM stereo	19
AM/FM stereo with CD	21
AM/FM stereo cassette with CD	24
AM/FM stereo with in-dash six CD	27
<b>Climate Controls</b>	<b>35</b>
Manual heating and air conditioning	35
Rear window defroster	44
<b>Lights</b>	<b>45</b>
Headlamps	45
Turn signal control	49
Bulb replacement	51
<b>Driver Controls</b>	<b>56</b>
Windshield wiper/washer control	56
Steering wheel adjustment	57
Power windows	67
Mirrors	69
Speed control	71
Message center	78
<b>Locks and Security</b>	<b>95</b>
Keys	95
Locks	95
Anti-theft system	109

## Table of Contents

<b>Seating and Safety Restraints</b>	<b>113</b>
Seating	113
Safety restraints	138
Airbags	153
Child restraints	167
<b>Tires, Wheels and Loading</b>	<b>182</b>
Tire information	182
Tire inflation	184
Tire Pressure Monitoring System (TPMS)	196
Vehicle loading	200
Trailer towing	206
Recreational towing	210
<b>Driving</b>	<b>211</b>
Starting	211
Brakes	214
Transmission operation	219
<b>Roadside Emergencies</b>	<b>225</b>
Getting roadside assistance	225
Hazard flasher switch	226
Fuel pump shut-off switch	227
Fuses and relays	227
Changing tires	235
Lug nut torque	245
Jump starting	245
Wrecker towing	251
<b>Customer Assistance</b>	<b>253</b>
Reporting safety defects (U.S. only)	259
<b>Cleaning</b>	<b>260</b>

## Table of Contents

<b>Maintenance and Specifications</b>	<b>267</b>
Engine compartment	269
Engine oil	271
Battery	274
Engine coolant	276
Fuel information	281
Air filter(s)	294
Part numbers	299
Maintenance product specifications and capacities	300
Engine data	302
<b>Accessories</b>	<b>305</b>
<b>Index</b>	<b>307</b>

All rights reserved. Reproduction by any means, electronic or mechanical including photocopying, recording or by any information storage and retrieval system or translation in whole or part is not permitted without written authorization from Ford Motor Company. Ford may change the contents without notice and without incurring obligation.

Copyright © 2006 Ford Motor Company

## Introduction

### CALIFORNIA Proposition 65 Warning



**WARNING:** Engine exhaust, some of its constituents, and certain vehicle components contain or emit chemicals known to the State of California to cause cancer and birth defects or other reproductive harm. In addition, certain fluids contained in vehicles and certain products of component wear contain or emit chemicals known to the State of California to cause cancer and birth defects or other reproductive harm.

### CONGRATULATIONS

Congratulations on acquiring your new Ford. Please take the time to get well acquainted with your vehicle by reading this handbook. The more you know and understand about your vehicle, the greater the safety and pleasure you will derive from driving it.

For more information on Ford Motor Company and its products visit the following website:

- In the United States: [www.ford.com](http://www.ford.com)
- In Canada: [www.ford.ca](http://www.ford.ca)
- In Australia: [www.ford.com.au](http://www.ford.com.au)
- In Mexico: [www.ford.com.mx](http://www.ford.com.mx)

Additional owner information is given in separate publications.

This *Owner's Guide* describes every option and model variant available and therefore some of the items covered may not apply to your particular vehicle. Furthermore, due to printing cycles it may describe options before they are generally available.

Remember to pass on this *Owner's Guide* when reselling the vehicle. It is an integral part of the vehicle.



**Fuel pump shut-off switch:** In the event of an accident the safety switch will automatically cut off the fuel supply to the engine. The switch can also be activated through sudden vibration (e.g. collision when parking). To reset the switch, refer to the *Fuel pump shut-off switch* in the *Roadside Emergencies* chapter.

### SAFETY AND ENVIRONMENT PROTECTION

#### **Warning symbols in this guide**

How can you reduce the risk of personal injury to yourself or others? In this guide, answers to such questions are contained in comments highlighted by the warning triangle symbol. These comments should be read and observed.

#### **Warning symbols on your vehicle**

When you see this symbol, it is imperative that you consult the relevant section of this guide before touching or attempting adjustment of any kind.



#### **Protecting the environment**

We must all play our part in protecting the environment. Correct vehicle usage and the authorized disposal of waste, cleaning and lubrication materials are significant steps towards this aim. Information in this respect is highlighted in this guide with the tree symbol.



### BREAKING-IN YOUR VEHICLE

Your vehicle does not need an extensive break-in. Try not to drive continuously at the same speed for the first 1,000 miles (1,600 km) of new vehicle operation. Vary your speed frequently in order to give the moving parts a chance to break in.

Drive your new vehicle at least 500 miles (800 km) before towing a trailer. For more detailed information about towing a trailer, refer to *Trailer towing* in the *Tires, Wheels and Loading* chapter.

Do not add friction modifier compounds or special break-in oils since these additives may prevent piston ring seating. See *Engine oil* in the *Maintenance and Specifications* chapter for more information on oil usage.

## Introduction

### SPECIAL NOTICES

#### New Vehicle Limited Warranty

For a detailed description of what is covered and what is not covered by your vehicle's New Vehicle Limited Warranty, refer to the *Warranty Guide* that is provided to you along with your *Owner's Guide*.

#### Special instructions

For your added safety, your vehicle is fitted with sophisticated electronic controls.



Please read the section *Supplemental restraint system (SRS)* in the *Seating and Safety Restraints* chapter. Failure to follow the specific warnings and instructions could result in personal injury.



Front seat mounted rear-facing child or infant seats should **NEVER** be placed in front of an active passenger airbag.

#### Service Data Recording

Service data recorders in your vehicle are capable of collecting and storing diagnostic information about your vehicle. This potentially includes information about the performance or status of various systems and modules in the vehicle, such as engine, throttle, steering or brake systems. In order to properly diagnose and service your vehicle, Ford Motor Company, Ford of Canada, and service and repair facilities may access vehicle diagnostic information through a direct connection to your vehicle when diagnosing or servicing your vehicle.

#### Event Data Recording

Other modules in your vehicle — event data recorders — are capable of collecting and storing data during a crash or near crash event. The recorded information may assist in the investigation of such an event. The modules may record information about both the vehicle and the occupants, potentially including information such as:

- how various systems in your vehicle were operating;
- whether or not the driver and passenger seatbelts were buckled;
- how far (if at all) the driver was depressing the accelerator and/or the brake pedal;

## Introduction

- how fast the vehicle was traveling; and
- where the driver was positioning the steering wheel.

To access this information, special equipment must be directly connected to the recording modules. Ford Motor Company and Ford of Canada do not access event data recorder information without obtaining consent, unless pursuant to court order or where required by law enforcement, other government authorities or other third parties acting with lawful authority. Other parties may seek to access the information independently of Ford Motor Company and Ford of Canada.

### Cell phone use

The use of Mobile Communications Equipment has become increasingly important in the conduct of business and personal affairs. However, drivers must not compromise their own or others' safety when using such equipment. Mobile Communications can enhance personal safety and security when appropriately used, particularly in emergency situations. Safety must be paramount when using mobile communications equipment to avoid negating these benefits.

Mobile Communication Equipment includes, but is not limited to cellular phones, pagers, portable email devices, in-vehicle communications systems, telematics devices and portable two-way radios.



A driver's first responsibility is the safe operation of the vehicle. The most important thing you can do to prevent a crash is to avoid distractions and pay attention to the road. Wait until it is safe to operate Mobile Communications Equipment.

### Middle East/North Africa vehicle specific information

For your particular global region, your vehicle may be equipped with features and options that are different from the ones that are described in this *Owner's Guide*; therefore, a supplement has been supplied that complements this book. By referring to the pages in the provided supplement, you can properly identify those features, recommendations and specifications that are unique to your vehicle. **Refer to this Owner's Guide for all other required information and warnings.**

## Introduction

These are some of the symbols you may see on your vehicle.





















### Vehicle Symbol Glossary

Safety Alert		See Owner's Guide	
Fasten Safety Belt		Airbag - Front	
Airbag - Side		Child Seat	
Child Seat Installation Warning		Child Seat Lower Anchor	
Child Seat Tether Anchor		Brake System	
Anti-Lock Brake System		Brake Fluid - Non-Petroleum Based	
Powertrain Malfunction		Speed Control	
Master Lighting Switch		Hazard Warning Flasher	
Fog Lamps-Front		Fuse Compartment	
Fuel Pump Reset		Windshield Wash/Wipe	
Windshield Defrost/Demist		Rear Window Defrost/Demist	



## Introduction

### Vehicle Symbol Glossary

Power Windows Front/Rear		Power Window Lockout	
Child Safety Door Lock/Unlock		Interior Luggage Compartment Release Symbol	
Panic Alarm		Engine Oil	
Engine Coolant		Engine Coolant Temperature	
Do Not Open When Hot		Battery	
Avoid Smoking, Flames, or Sparks		Battery Acid	
Explosive Gas		Fan Warning	
Power Steering Fluid		Maintain Correct Fluid Level	
Emission System		Engine Air Filter	
Passenger Compartment Air Filter		Jack	
Check Fuel Cap		Low Tire Pressure Warning	

## Instrument Cluster

### WARNING LIGHTS AND CHIMES

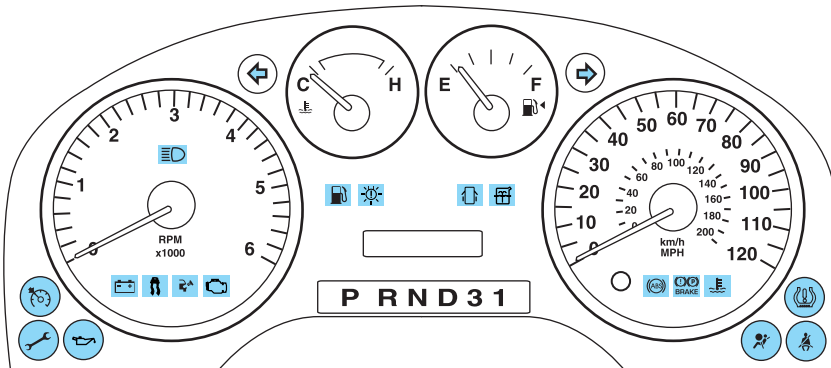

### Standard instrument cluster

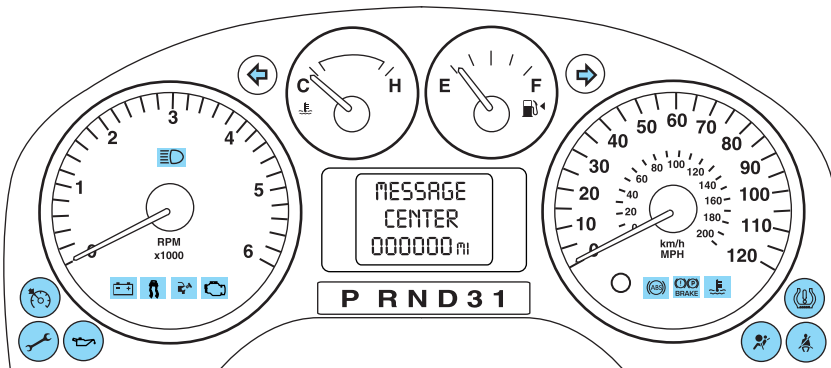

### Optional instrument cluster

Warning lights and gauges can alert you to a vehicle condition that may become serious enough to cause extensive repairs. A warning light may illuminate when a problem exists with one of your vehicle's functions. Many lights will illuminate when you start your vehicle to make sure the

## Instrument Cluster

bulb works. If any light remains on after starting the vehicle, refer to the respective system warning light for additional information.

**Check engine:** The *Check Engine* indicator light illuminates when the ignition is first turned to the ON position to check the bulb. Solid

illumination after the engine is started indicates the On Board Diagnostics System (OBD-II) has detected a malfunction. Refer to *On board diagnostics (OBD-II)* in the *Maintenance and Specifications* chapter. If the light is blinking, engine misfire is occurring which could damage your catalytic converter. Drive in a moderate fashion (avoid heavy acceleration and deceleration) and have your vehicle serviced immediately by your authorized dealer.



Under engine misfire conditions, excessive exhaust temperatures could damage the catalytic converter, the fuel system, interior floor coverings or other vehicle components, possibly causing a fire.

**Check fuel cap:** Illuminates when the fuel cap may not be properly installed. Continued driving with this light on may cause the Check engine warning light to come on, refer to *Fuel filler cap* in the *Maintenance and Specification* chapter.



**Brake system warning light:** To confirm the brake system warning light is functional, it will momentarily illuminate when the ignition is turned to the ON position when the engine is not running, or in a position between ON and START, or by applying the parking brake when the ignition is turned to the ON position. If the brake system warning light does not illuminate at this time, seek service immediately from your authorized dealer. Illumination after releasing the parking brake indicates low brake fluid level and the brake system should be inspected immediately by your authorized dealer.



## Instrument Cluster



Driving a vehicle with the brake system warning light on is dangerous. A significant decrease in braking performance may occur. It will take you longer to stop the vehicle. Have the vehicle checked by your authorized dealer.

**Anti-lock brake system:** If the ABS light stays illuminated or continues to flash, a malfunction has been detected, have the system serviced immediately by your authorized dealer. Normal braking is still functional unless the brake warning light also is illuminated.



**Airbag readiness:** If this light fails to illuminate when ignition is turned to ON, continues to flash or remains on, have the system serviced immediately by your authorized dealer. A chime will also sound when a malfunction in the supplemental restraint system has been detected.



**Safety belt:** Reminds you to fasten your safety belt. A BeltMinder® chime will also sound to remind you to fasten your safety belt. Refer to the *Seating and safety restraints* chapter to activate/deactivate the BeltMinder® chime feature.



**Malfunction indicator:** Illuminates when a powertrain fault has been detected. Contact your authorized dealer as soon as possible.



**Charging system:** Illuminates when the battery is not charging properly.



**Engine oil pressure:** Illuminates when the oil pressure falls below the normal range, refer to *Engine oil* in the *Maintenance and Specifications* chapter.



## Instrument Cluster

### Engine coolant temperature:

Illuminates when the engine coolant temperature is high. Stop the vehicle as soon as possible, switch off the engine and let cool. Refer to *Engine coolant* in the *Maintenance and Specifications* chapter.



Never remove the coolant reservoir cap while the engine is running or hot.

### Traction Control™ or AdvanceTrac® active (if equipped):

Illuminates when the Traction Control™ is active, refer to the *Driving* chapter for more information.



### Low tire pressure warning:

Illuminates when your tire pressure is low. If the light remains ON at start up or while driving, the tire pressure should be checked. Refer to *Inflating Your Tires* in the *Tires, Wheels and Loading* chapter. When the ignition is first turned to ON, the light will illuminate for 3 seconds to ensure the bulb is working. If the light does not turn ON, have the system inspected by your authorized dealer. For more information on this system, refer to *Understanding Your Tire Pressure Monitoring System* in the *Tires, Wheels and Loading* chapter.

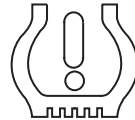

**Low fuel:** Illuminates when the fuel level in the fuel tank is at or near empty (refer to *Fuel gauge* in this chapter).

- Without Message Center



- With Message Center

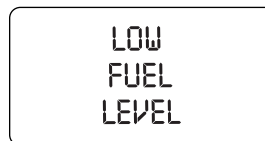

## Instrument Cluster

**Speed control:** Illuminates when the speed control is engaged. Turns off when the speed control system is disengaged.



**Low washer fluid:** Illuminates when the windshield washer fluid is low.

- Without Message Center



- With Message Center

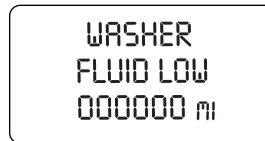

**Door ajar:** Illuminates when the ignition is in the ON position and any door is open.

- Without Message Center



- With Message Center

Displays which door or the liftgate is open.



**Turn signal:** Illuminates when the left or right turn signal or the hazard lights are turned on. If the indicators stay on or flash faster, check for a burned out bulb.



## Instrument Cluster

**Bulb warning:** Illuminates when one of the exterior front turn lamps or rear brake/turn/tail lamps bulb has burned out.

- Without Message Center



- With Message Center

Displays which bulb is burned out.  
Depress the RESET control to clear.



**High beams:** Illuminates when the high beam headlamps are turned on.



**Key-in-ignition warning chime:** Sounds when the key is left in the ignition in the OFF/LOCK or ACCESSORY position and the driver's door is opened.

**Headlamps on warning chime:** Sounds when the headlamps or parking lamps are on, the ignition is off (the key is not in the ignition) and the driver's door is opened.

**Turn signal warning chime:** Sounds when the turn signal lever has been activated to signal a turn and not turned off after the vehicle is driven more than 2 miles (3.2 km).

## Instrument Cluster

### GAUGES

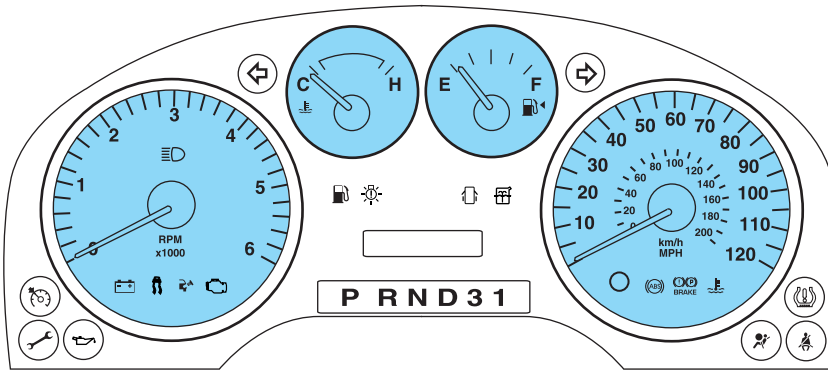

**Speedometer:** Indicates the current vehicle speed.

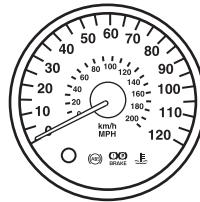

**Engine coolant temperature gauge:** Indicates engine coolant temperature. At normal operating temperature, the needle will be in the normal range (between “H” and “C”). **If it enters the red section, the engine is overheating. Stop the vehicle as soon as safely possible, switch off the engine and let the engine cool.**

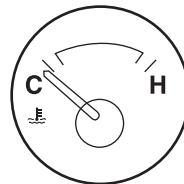

Never remove the coolant reservoir cap while the engine is running or hot.



## Instrument Cluster

**Odometer:** Registers the total miles (kilometers) of the vehicle.

- Without Message Center

To switch the display from Metric to English, press and hold the button on the cluster for three seconds.



The temperature display in the overhead console (if equipped) will also be changed.

- With Message Center

Refer to *Message Center* in the *Driver Controls* chapter on how to switch the display from Metric to English.



**Trip odometer:** Registers the miles (kilometers) of individual journeys.

- Without Message Center

Press and release the button on the cluster to toggle between odometer and trip odometer display. To reset, press the button again until the trip reading is 000000.0 miles.



To switch the odometer display and temperature from English to Metric. With the mileage displayed press and hold the button on the cluster for three seconds this will change the units.

- With Message Center

To reset, press and hold the message center RESET button for three seconds to reset.

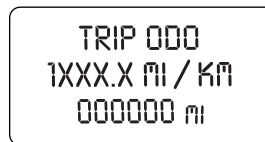

**Tachometer:** Indicates the engine speed in revolutions per minute. Driving with your tachometer pointer continuously at the top of the scale may damage the engine.

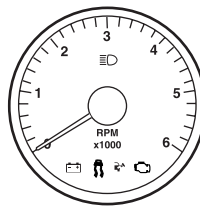

## Instrument Cluster

**Fuel gauge:** Indicates approximately how much fuel is left in the fuel tank (when the ignition is in the ON position). The fuel gauge may vary slightly when the vehicle is in motion or on a grade.

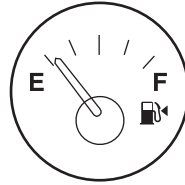

The arrow near the fuel pump icon indicates which side of the vehicle the fuel filler door is located.

Refer to *Filling the tank* in the *Maintenance and Specifications* chapter for more information.

## Entertainment Systems

### AUDIO SYSTEMS

#### AM/FM stereo system (if equipped)

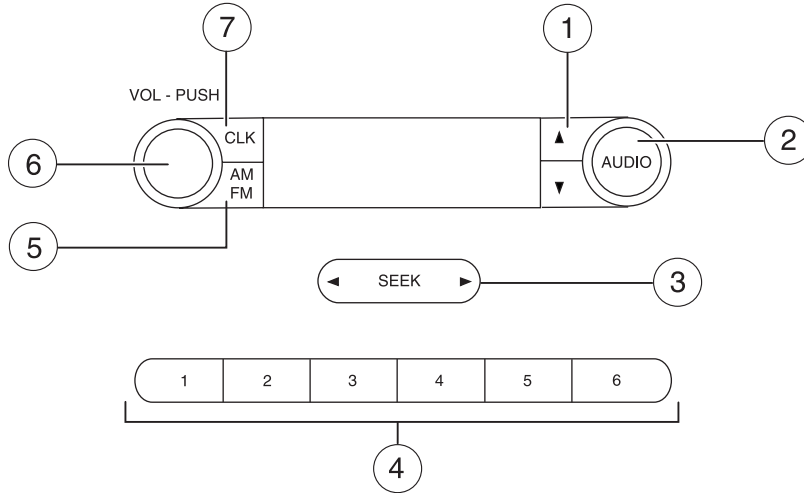

1. **▲ / ▼ Tuner:** Press to manually go up or down the radio frequency. Also use in menu mode to select various settings.



2. **Audio:** Press to access select various settings.



**Treble:** Press to adjust the treble setting. Use ▲ / ▼ / ◀ SEEK ▶ .

**Bass:** Press to adjust the bass setting. Use ▲ / ▼ / ◀ SEEK ▶ .

**Balance:** Press to adjust the audio between the left and right speakers. Use ▲ / ▼ / ◀ SEEK ▶ .

**Fade:** Press to adjust the audio between the front and rear speakers. Use ▲ / ▼ / ◀ SEEK ▶ .

## Entertainment Systems

3. **Seek:** Press to access the next/previous strong station or track.



4. **Memory presets:** To set a station: Select frequency band AM/FM; tune to a station, press and hold a preset button until sound returns.



5. **AM/FM:** Press to select AM/FM frequency band.



6. **ON/OFF/Volume:** Press to turn ON/OFF. Turn to increase/decrease volume.

VOL - PUSH



If the volume is set above a certain level and the ignition is turned off, the volume will come back on at a “nominal” listening level when the ignition switch is turned back on.

7. **CLK (Clock):** Press to toggle between the clock and radio display. To set the clock: Press and hold CLK until the hours begin to flash.



Press ▼ / ▲ to manually decrease / increase the hours. Press CLK again to set the minutes.

When this audio is used in cargo vans where no rear speakers are installed in the vehicle, fading to the rear speakers will result in no audio output.

## Entertainment Systems

### AM/FM stereo/ single CD sound system (if equipped)

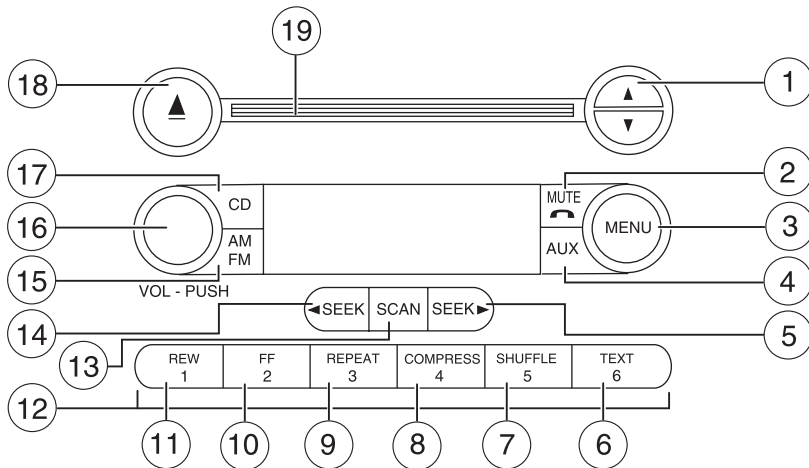

1. **▲ / ▼ Tuner:** Press to manually go up or down the radio frequency. Also use in menu mode to select various settings.



2. **Phone/mute:** Press to mute the playing media. Press again to return to the playing media.



3. **Menu:** Press to toggle through the following modes:



**Autoset:** Allows you to set the strongest local radio stations without losing your original manually set preset stations for AM/FM1/FM2 . Press MENU to access. Use ▲ / ▼ / ◀ SEEK ▶ to set.

When the six strongest stations are filled, the station stored in preset 1 will begin playing. If there are less than six strong stations, the system will store the last one in the remaining presets.

**Bass:** Press to adjust the bass setting. Use ▲ / ▼ / ◀ SEEK ▶ .

## Entertainment Systems

**Treble:** Press to adjust the treble setting. Use ▲ / ▼ / ◀ SEEK ▶ .

**Balance:** Press to adjust the audio between the left and right speakers. Use ▲ / ▼ / ◀ SEEK ▶ .

**Fade:** Press to adjust the audio between the front and rear speakers. Use ▲ / ▼ / ◀ SEEK ▶ .

**Speed sensitive volume (if equipped):** Radio volume automatically changes slightly with vehicle speed to compensate for road and wind noise. Press MENU to access and use ▲ / ▼ / ◀ SEEK ▶ to adjust.

The recommended level is 1–3. Level 0 (SPEED OFF) turns the feature off and level 7 is the maximum setting

**Setting the clock:** Press MENU until HOURS SET or MINUTES SET is displayed. Use ▲ / ▼ to manually increase/decrease Press MENU again to disengage clock mode.

If your vehicle is equipped with an in-dash clock, refer to *Clock* in the *Driver Controls* chapter for instructions on how to set the time.

4. **Aux:** Press to toggle between FES/DVD and AUX modes. If no auxiliary sources are available, NO AUX AUDIO will be displayed.



5. **Seek:** Press to access the next strong station or track.



6. **Text:** In CD mode, this feature reads track name, artist name, and disc name (if available).



7. **Shuffle:** Press to play tracks in random order.



8. **Comp (Compression):** In CD mode, brings soft and loud CD passages together for a more consistent listening level.



9. **Repeat:** Press to repeat the current CD track.



## Entertainment Systems

10. **Fast forward:** Press to manually advance in a CD track.



11. **Rewind:** Press to manually reverse in a CD track.



12. **Memory presets:** To set a station: Select frequency band AM/FM; tune to a station, press and hold a preset button until sound returns.



13. **Scan:** Press for a brief sampling of radio stations or CD tracks. Press again to stop.



14. **Seek:** Press to access the previous strong station or track.



15. **AM/FM:** Press to select AM/FM frequency band.



16. **ON/OFF/Volume:** Press to turn ON/OFF. Turn to increase/decrease volume.



If the volume is set above a certain level and the ignition is turned off, the volume will come back on at a "nominal" listening level when the ignition switch is turned back on.

17. **CD:** Press to enter CD mode. If a CD is already loaded into the system, CD play will begin where it ended last.



18. **CD eject:** Press to eject a CD.



19. **CD slot:** Insert a CD label side up.



## Entertainment Systems

### AM/FM stereo cassette/single CD sound system (if equipped)

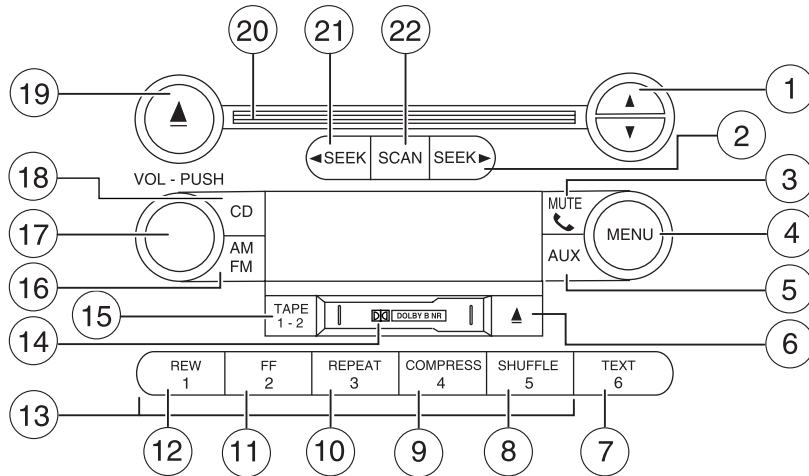

1. **▲ / ▼ Tuner:** Press to manually go up or down the radio frequency. Also use in menu mode to select various settings.



2. **Seek:** Press to access the next strong station or track.



3. **Phone/mute:** Press to mute the playing media. Press again to return to the playing media.



4. **Menu:** Press to toggle through the following modes:



**Treble:** Press to adjust the treble setting. Use ▲ / ▼ / ◀ SEEK ▶ .

**Bass:** Press to adjust the bass setting. Use ▲ / ▼ / ◀ SEEK ▶ .

**Balance:** Press to adjust the audio between the left and right speakers. Use ▲ / ▼ / ◀ SEEK ▶ .



## Entertainment Systems

**Fade:** Press to adjust the audio between the front and rear speakers. Use ▲ / ▼ / ◀ SEEK ▶ .

**Speed sensitive volume (if equipped):** Radio volume automatically changes slightly with vehicle speed to compensate for road and wind noise. Press MENU to access and use ▲ / ▼ / ◀ SEEK ▶ to adjust. The recommended level is 1–3. Level 0 (SPEED OFF) turns the feature off and level 7 is the maximum setting

**Setting the clock:** Press MENU until HOURS SET or MINUTES SET is displayed. Press ▲ / ▼ / ◀ SEEK ▶ to adjust the hours/minutes.

If your vehicle is equipped with an in-dash clock, refer to *Clock* in the *Driver Controls* chapter for instructions on how to set the time.

**Autoset:** Allows you to set the strongest local radio stations without losing your original manually set preset stations for AM/FM1/FM2 . Press MENU to access. Use ▲ / ▼ / ◀ SEEK ▶ to set.

When the six strongest stations are filled, the station stored in preset 1 will begin playing. If there are less than six strong stations, the system will store the last one in the remaining presets.

**Clean tape reminder:** After 20 hours of cassette operation, the radio will notify you that it is time to clean the cassette player head. After cleaning the player head, you can clear the reminder through menu control and selecting YES.

5. **AUX:** Press to toggle between FES/DVD and AUX modes. If no auxiliary sources are available, NO AUX AUDIO will be displayed. To return to radio mode, press AM/FM.



6. **Tape eject:** Press to eject a tape.



7. **Text:** In CD mode, displays track title, artist name, and disc title (if available).

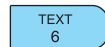

8. **Shuffle:** Press to play CD tracks in random order.



## Entertainment Systems

9. **Compress (Compression):** In CD mode, brings soft and loud CD passages together for a more consistent listening level.



10. **Repeat:** Press to repeat the current CD track.



11. **Fast forward:** Press to manually advance in a CD track or cassette.



12. **Rewind:** Press to manually reverse in a CD track or cassette.



13. **Memory presets:** To set a station: Select frequency band AM/FM; tune to a station, press and hold a preset button until sound returns.



14. **Tape:** Insert a tape facing to the right.



15. **Tape direction:** Press to enter tape mode. Press while in play mode to change which side of the tape is playing.



16. **AM/FM:** Press to select AM/FM frequency band.



17. **ON/OFF/Volume:** Press to turn ON/OFF. Turn to increase/decrease volume.

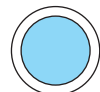

VOL - PUSH

If the volume is set above a certain level and the ignition is turned off, the volume will come back on at a "nominal" listening level when the ignition switch is turned back on.

18. **CD:** Press to enter CD mode. If a CD is already loaded into the system, CD play will begin where it ended last.



## Entertainment Systems

19. **CD eject:** Press to eject a CD.



20. **CD slot:** Insert a CD label side up.



21. **Seek:** Press to access the previous strong station or track.



22. **Scan:** Press for a brief sampling of radio stations or CD tracks. Press again to stop.



When this radio is used in cargo vans where no rear speakers are installed in the vehicle, fading to the rear speakers will result in no audio output.

### Premium In-Dash Six CD Sound System (if equipped)

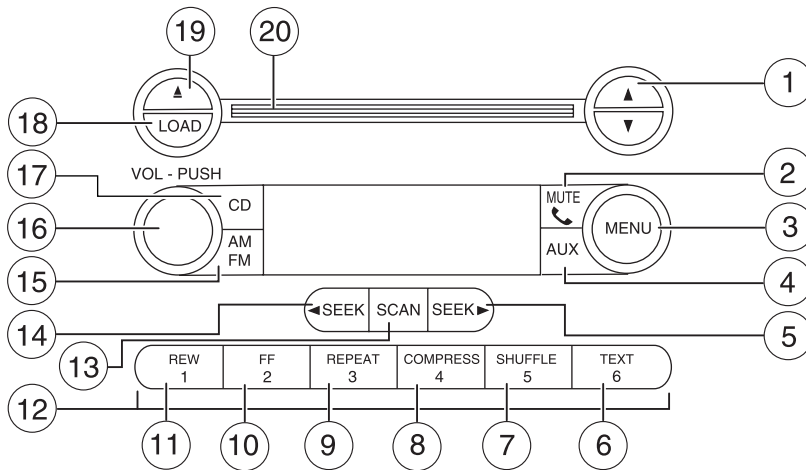

## Entertainment Systems

1. **▲ / ▼ Tuner:** Press to manually go up or down the radio frequency. Also use in menu mode to select various settings.



2. **Phone/mute:** Press to mute the playing media. Press again to return to the playing media.



3. **Menu:** Press to toggle through the following modes:



**Treble:** Press to adjust the treble setting. Use ▲ / ▼ / ◀ SEEK ▶ .

**Bass:** Press to adjust the bass setting. Use ▲ / ▼ / ◀ SEEK ▶ .

**Balance:** Press to adjust the audio between the left and right speakers. Use ▲ / ▼ / ◀ SEEK ▶ .

**Fade:** Press to adjust the audio between the front and rear speakers. Use ▲ / ▼ / ◀ SEEK ▶ .

**Speed sensitive volume (if equipped):** Radio volume automatically changes slightly with vehicle speed to compensate for road and wind noise. Press MENU to access and use ▲ / ▼ / ◀ SEEK ▶ to adjust. The recommended level is 1–3. Level 0 (SPEED OFF) turns the feature off and level 7 is the maximum setting.

**Setting the clock:** Press MENU until HOURS SET or MINUTES SET is displayed. Press ▲ / ▼ / ◀ SEEK ▶ to adjust the hours/minutes.

If your vehicle is equipped with an in-dash clock, refer to *Clock* in the *Driver Controls* chapter for instructions on how to set the time.

**Autoset:** Allows you to set the strongest local radio stations without losing your original manually set preset stations for AM/FM1/FM2 . Press MENU to access. Use ▲ / ▼ / ◀ SEEK ▶ to set.

When the six strongest stations are filled, the station stored in preset 1 will begin playing. If there are less than six strong stations, the system will store the last one in the remaining presets.

## Entertainment Systems

4. **Aux:** Press to toggle between FES/DVD and AUX modes. If no auxiliary sources are available, NO AUX AUDIO will be displayed.



5. **Seek:** Press to access the next strong station or track.



6. **Text:** In CD mode, press to display the track name, artist name and disc name (if available).



7. **Shuffle:** Press to play tracks in random order.



8. **Comp (Compression):** In CD mode, brings soft and loud CD passages together for a more consistent listening level.



9. **Repeat:** Press to repeat the current CD track.



10. **Fast forward:** Press to manually advance in a CD track.



11. **Rewind:** Press to manually reverse in a CD track.



12. **Memory presets:** To set a station: Select frequency band AM/FM; tune to a station, press and hold a preset button until sound returns.



13. **Scan:** Press for a brief sampling of radio stations or CD tracks. Press again to stop.



14. **Seek:** Press to access the previous strong station or track.



15. **AM/FM:** Press to select AM/FM frequency band.



## Entertainment Systems

16. **ON/OFF/Volume:** Press to turn ON/OFF. Turn to increase/decrease volume.

If the volume is set above a certain level and the ignition is turned off, the volume will come back on at a “nominal” listening level when the ignition switch is turned back on.



VOL - PUSH

17. **CD:** Press to enter CD mode. If a CD is already loaded into the system, CD play will begin where it ended last.



18. **LOAD:** Press to load a CD, then select a slot number using the radio presets 1 through 6. If you don't select a slot within 5 seconds, the radio shall choose the first available slot for you. Press and hold for 2 seconds to auto load up to six CDs.



19. **CD eject:** Press to eject a CD, then select the desired CD slot using the radio presets 1 through 6.

If a slot is not selected within 5 seconds, the radio shall eject the current disc. Press and hold for 2 seconds to auto eject all CDs present in the radio mechanism.



20. **CD slot:** Insert a CD label side up.





### Auxiliary audio controls (if equipped)

Your vehicle may be equipped with auxiliary audio controls. This feature allows the front and middle seat passengers to listen to different media sources (radio, cassette, CD or DVD) simultaneously. (However, the front and middle-seat passengers cannot listen to two different radio stations at the same time.)

## Entertainment Systems

1. **Volume:** Press to ► / ◀ increase/decrease volume control.

2. **Media:** Press to select from different playing medias.

3.  /  : Press to activate dual play mode and enable the rear seat passengers to hear audio through the headphones. Press again to deactivate.

4. **MEM:** Press consecutively to scroll through the preset stations, change tape side (if equipped), or to change discs on multiple disc radios (if equipped).

5. **SEEK:** Press ► / ◀ to access the next/previous strong radio station, cassette selection or CD track.

When the rear seat controls are activated, rear seat passengers can use the controls to change the playing media for all passengers (Single Play mode). In this mode, all speakers will play audio from the same media source for all passengers to hear.

If there is a discrepancy between the rear seat controls and the front audio controls (such as both trying to listen to the same playing media), the front audio system will receive the desired selection.

To activate Dual Play mode (rear seat passengers listen to a different playing media than the front seat passengers):

- Press the speaker/headphone control.
- Press MEDIA to change audio sources (for headphone mode only).
- Use the SEEK, VOLUME and MEMORY controls to make adjustments to the playing media.

### Parental control

Simultaneously press the radio preset controls 3 and 5 to enable/disable the rear seat audio controls as well as the Family Entertainment system (if equipped).

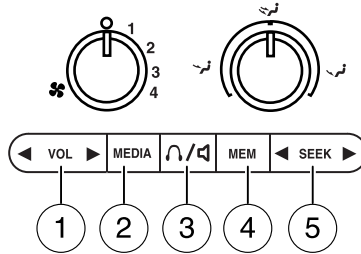

## Entertainment Systems

### Dual play mode

Press  on the rear seat audio controls or simultaneously press the radio preset controls 2 and 4 to enable/disable dual play.



During dual play, the rear vehicle speakers will be deactivated and the wired headphones (if equipped) will become active. Two different medias can be played in the vehicle simultaneously:

- The driver can select a media from the main radio face (radio, tape, CD or DVD if equipped) and listen using the front speakers.
- Rear seat passengers may listen to a different media source than the front passengers (radio, tape, CD or DVD if equipped) using 3.5 mm wired headphones (not included) that shall be plugged into the headphone icon jacks on the rear audio control face. Infrared headphones are included in vehicles equipped with the Family Entertainment System and shall only be used to listen to the media (DVD or CD) that is playing in the Family Entertainment System. Wireless headphones **will not play** audio from any other sources (AM, FM, tape, or Radio CD).

The front and rear seat passengers cannot listen to two different radio stations at the same time.

### GENERAL AUDIO INFORMATION

#### Radio frequencies:

AM and FM frequencies are established by the Federal Communications Commission (FCC) and the Canadian Radio and Telecommunications Commission (CRTC). Those frequencies are:

AM: 530, 540 – 1700, 1710 kHz

FM: 87.7, 87.9 – 107.7, 107.9 MHz

#### Radio reception factors:

There are three factors that can affect radio reception:

- Distance/strength: The further you travel from a station, the weaker the signal and the weaker the reception.
- Terrain: Hills, mountains, tall buildings, power lines, electric fences, traffic lights and thunderstorms can interfere with your reception.
- Station overload: When you pass a broadcast tower, a stronger signal may overtake a weaker one and play while the weak station frequency is displayed.



## Entertainment Systems

### Cassette/player care

Do:

- Tighten very loose tapes by inserting a pen or pencil into the hole and turning the hub.
- Remove loose labels before inserting tapes.
- Allow tapes which have been subjected to extreme heat, humidity or cold to reach a moderate temperature before playing.
- Clean the cassette player head with a cassette cleaning cartridge after 10–12 hours of play to maintain good sound/operation.

Don't:

- Use cassettes that are longer than 90 minutes.
- Expose tapes to direct sunlight, extreme humidity, heat or cold.
- Leave tapes in the cassette player for a long time when not being played.

### CD/CD player care

Do:

- Handle discs by their edges only. Never touch the playing surface.
- Inspect discs before playing. Clean only with an approved CD cleaner and wipe from the center out.

Don't:

- Expose discs to direct sunlight or heat sources for extended periods of time.
- For vehicles equipped with a six disc CD changer, don't insert more than one disc into each slot of the CD changer magazine.
- Clean using a circular motion.

**CD units are designed to play commercially pressed 4.75 in (12 cm) audio compact discs only. Due to technical incompatibility, certain recordable and re-recordable compact discs may not function correctly when used in Ford CD players. Irregular shaped CDs, CDs with a scratch protection film attached, and CDs with homemade paper (adhesive) labels should not be inserted into the CD player. The label may peel and cause the CD to become jammed. It is recommended that homemade CDs be identified with permanent felt tip marker rather than adhesive labels. Ballpoint pens may damage CDs. Please contact your authorized dealer for further information.**

## Entertainment Systems

### **Audio system warranty and service**

Refer to the *Warranty Guide* for audio system warranty information. If service is necessary, see your dealer or qualified technician.

### **FAMILY ENTERTAINMENT SYSTEM (IF EQUIPPED)**

Your vehicle may be equipped with a Family Entertainment System (FES). Refer to the *DVD Supplement Guide* for further information on your system.

## Climate Controls

### MANUAL HEATING AND AIR CONDITIONING SYSTEM (IF EQUIPPED)

#### 1. Temperature selection:

Controls the temperature of the airflow in the vehicle.

2. **Air flow selections:** Controls the direction of the airflow in the vehicle. See the following for a brief description on each control.

**MAX A/C:** Distributes recirculated air through the instrument panel vents only to cool the vehicle. This re-cooling of the interior air is more economical and efficient. Recirculated air may also help reduce undesirable odors from entering the vehicle.

 : Distributes air through the instrument panel vents.

 : Distributes air through the instrument panel vents and the floor vents.

**O (OFF):** Outside air is shut out and the fan will not operate.



 : Distributes air through the floor vents.

 : Distributes air through the windshield defroster vents and floor vents.

 : Distributes outside air through the windshield defroster vents. Can be used to clear ice or fog from the windshield.

3.  **Rear defroster:** Press to defrost the rear window. Refer to *Rear window defroster* later in this chapter for more information.

4.  **Recirculated air:** Press to activate/deactivate air recirculation in cabin. Recirculated air may reduce the amount of time to cool down the interior of the vehicle and may also help reduce undesired odors from reaching the interior of the vehicle. Recirculation engages automatically with selection of MAX A/C or can be engaged manually in any other airflow selection except defrost. Recirculation may turn off automatically in all airflow selections except MAX A/C.

5. **A/C:** Press to activate/deactivate air conditioning. Use with recirculated air to improve cooling performance and efficiency. Engages automatically in MAX A/C,  and .

6. **Fan speed adjustment:** Controls the volume of air circulated in the vehicle.

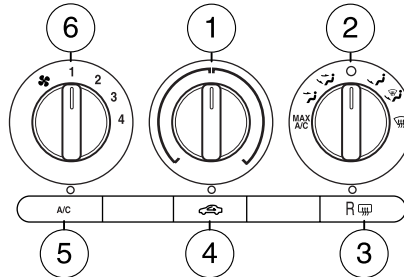

## Climate Controls

### Dual zone manual heating and air conditioning system with rear passenger compartment climate control (if equipped)

1. **Air flow selections:** Controls the direction of the airflow in the vehicle. See the following for a brief description on each control.

**MAX A/C:** Distributes recirculated air through the instrument panel vents only to cool the vehicle. This re-cooling of the interior air is more economical and efficient.

Recirculated air may also help reduce undesirable odors from entering the vehicle.

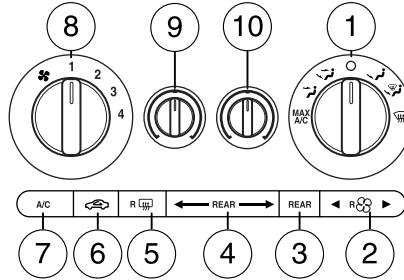

: Distributes air through the instrument panel vents.

: Distributes air through the instrument panel vents and the floor vents.

**O (OFF):** Outside air is shut out and the climate system is turned off.

: Distributes air through the floor vents.

: Distributes air through the windshield defroster vents and floor vents.

: Distributes outside air through the windshield defroster vents. Can be used to clear thin ice or fog from the windshield.

**Auxiliary climate control operation:** Turn the front air flow control (1) to any position except O (OFF).

2. **R Rear fan speed control:** Press to enable the auxiliary system or to adjust the rear fan speed from the front control. The rear fan speed settings available are 4, 3, 2, 1 and O (OFF).



3. **REAR:** Press to enable the control located in the rear seat. Press again to turn the auxiliary system off.



4. **◀ REAR ▶ Rear temperature control:** Press to enable the auxiliary system and to set the desired rear cabin airflow temperature with the front control. The rear cabin airflow temperature will match the driver airflow temperature setting when only the center rear temperature light (◀ **REAR** ▶) is illuminated. The rear cabin airflow temperature

## Climate Controls

will be warmer or cooler than the driver airflow temperature setting when more than one rear temperature light ( ◀ REAR ▶ ) is illuminated.

5.  **Rear defroster:** Press to activate/deactivate rear window defroster. Refer to *Rear window defroster* later in this chapter for more information.

6.  **Recirculated air:** Press to activate/deactivate air recirculation in cabin. Recirculated air may reduce the amount of time to cool down the interior of the vehicle and may also help reduce undesired odors from reaching the interior of the vehicle. Recirculation engages automatically with selection of MAX A/C or can be engaged manually in any other airflow selection except  . Recirculation may turn off automatically in all airflow selections except MAX A/C.

7. **A/C:** Press to activate/deactivate air conditioning. Use with  recirculated air to improve cooling performance and efficiency. Engages automatically in MAX A/C,  and  .

8. **Fan speed adjustment:** Controls the volume of air circulated in the vehicle.

9. **Left temperature selection:** Controls the temperature of the airflow to the driver in the front of the vehicle.

10. **Right temperature selection:** Controls the temperature of the airflow to the passenger in the front of the vehicle.

### Operating tips



- To reduce fog build up on the windshield during humid weather, place the air flow selector in the  position.
- To reduce humidity build up inside the vehicle: do not drive with the airflow selector in the O (OFF) or with recirculated air engaged.
- Do not put objects under the front seats that will interfere with the airflow to the back seats.
- Remove any snow, ice or leaves from the air intake area at the base of the windshield.
- For maximum cooling performance (MAX A/C):

In the MAX A/C mode:

- Move the temperature control selector to the coldest setting.
- Set the fan to the highest speed initially, then adjust to maintain passenger comfort.

## Climate Controls

In the  and  modes:

- Move the temperature control selector to the coldest setting.
- Select A/C and recirculated air . Use  with A/C to provide colder airflow.
- Set the fan to the highest speed initially, then adjust to maintain passenger comfort.

In extremely cold temperatures, to maximize overall heater performance it is suggested to not operate the auxiliary system (if so equipped) until the engine temperature gauge crosses into the normal operating range.

To aid in side window defogging/demisting in cold weather:

1. Select .
2. Select A/C.
3. Set the temperature control to full heat.
4. Set the fan speed to the highest setting.
5. Direct the outer instrument panel vents towards the side windows.



Do not place objects on top of the instrument panel as these objects may become projectiles in a collision or sudden stop.

## Climate Controls

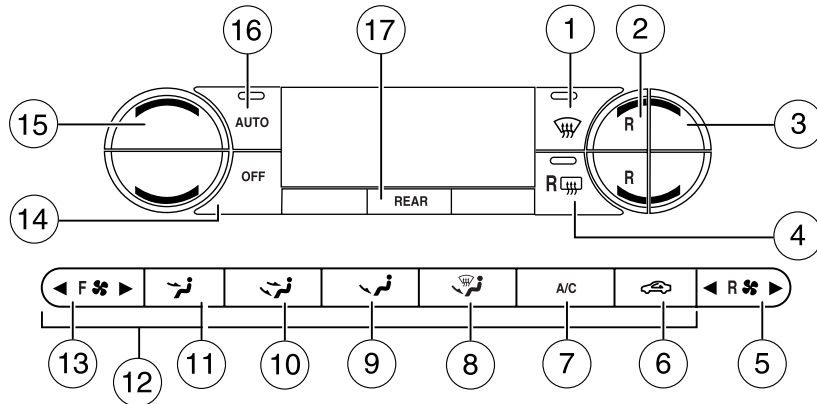

### DUAL ZONE AUTOMATIC TEMPERATURE CONTROL WITH REAR PASSENGER COMPARTMENT CLIMATE CONTROL (IF EQUIPPED)





1. **Defrost:** Distributes outside air through the windshield defroster vents. Can be used to clear thin ice or fog from the windshield.
2. **Rear temperature control:** Press to enable the auxiliary system and set the desired rear cabin airflow temperature with the front control. The rear cabin airflow temperature will match the driver airflow temperature setting when only the center rear temperature bar (**REAR**) is illuminated. The rear cabin airflow temperature will be warmer or cooler than the driver airflow temperature setting when more than one rear temperature bar (**REAR**) is illuminated.
3. **Passenger temperature control:** Press to increase/decrease the temperature for the passenger in the front of the vehicle.
4. **Rear defroster:** Press to activate/deactivate the rear window defroster. Refer to *Rear window defroster* later in this chapter for more information.
5. **Rear fan speed control:** Press to enable the auxiliary system or to adjust the rear fan speed from the front control. The rear fan speed settings available are 4, 3, 2, 1 and O (OFF).
6. **Recirculated air:** Press to activate/deactivate air recirculation in the vehicle cabin. Recirculated air may reduce the amount of time to cool down the interior of the vehicle and may also help reduce undesired odors from reaching the interior of the vehicle. Recirculated air can be

## Climate Controls

engaged manually in any airflow selection except . Recirculated air may turn off automatically in all airflow selections.

7. **A/C**: Press to activate/deactivate air conditioning. Use with  recirculated air to improve cooling performance and efficiency. Engages automatically in AUTO, , and .

8. : Distributes air through the windshield defroster vents and floor vents.

9. : Distributes air through the floor vents.

10. : Distributes air through the instrument panel vents and the floor vents.

11. : Distributes air through the instrument panel vents.

12. **Manual override controls**: Allows you to change the system operation. To return to full automatic control, press AUTO.

13. **F  Front fan speed control**: Press to manually increase or decrease the fan speed. To return to full automatic control, press AUTO.

14. **OFF**: Outside air is shut out and the climate system is turned off.

15. **Driver temperature control**: Press to increase or decrease the temperature on the driver side of the cabin. Sets the passenger side temperature also when DUAL is disengaged. **Note**: The recommended vehicle cabin setting is between 72°F (22°C) and 75°F (24°C).

- **Dual temperature control**: Press and hold AUTO to engage/disengage separate passenger side temperature control.

16. **AUTO**: Press to engage full automatic operation, and select the desired temperature using the temperature control. The system will automatically determine fan speed, airflow location, A/C on or off, and outside or recirculated air, to heat or cool the vehicle to reach the desired temperature.





17. **REAR**: Press to enable the control located in the rear seat. Press again to turn the auxiliary system off.



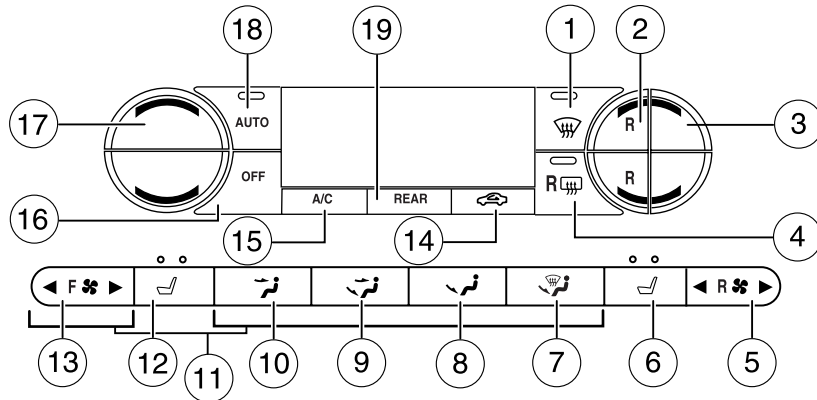









## Climate Controls

### Dual zone automatic temperature control with heated seats and rear passenger compartment climate control (if equipped)



1.  **Defrost:** Distributes outside air through the windshield defroster vents. Can be used to clear thin ice or fog from the windshield.
2. **Rear temperature control:** Press to enable the auxiliary system and set the desired rear cabin airflow temperature with the front control. The rear cabin airflow temperature will match the driver airflow temperature setting when only the center rear temperature bar (**REAR**) is illuminated. The rear cabin airflow temperature will be warmer or cooler than the driver airflow temperature setting when more than one rear temperature bar (**REAR**) is illuminated.
3. **Passenger temperature control:** Press to increase/decrease the temperature for the passenger in the front of the vehicle.
4.  **Rear defroster:** Press to activate/deactivate the rear window defroster. Refer to *Rear window defroster* later in this chapter for more information.
5. **R  Rear fan speed control:** Press to enable the auxiliary system or to adjust the rear fan speed from the front control. The rear fan speed settings available are 4, 3, 2, 1 and O (OFF).
6.  **Passenger heated seat control:** Press once to activate the high heat setting (2 indicator lights). Press again to activate the low heat setting (1 indicator light). Press again to deactivate the passenger heated seat.

## Climate Controls

7.  : Distributes air through the windshield defroster vents and the floor vents.
8.  : Distributes air through the floor vents.
9.  : Distributes air through the instrument panel vents and the floor vents.
10.  : Distributes air through the instrument panel vents.
11. **Manual override controls:** Allows you to change the system operation. To return to full automatic control, press AUTO.
12.  **Driver heated seat control:** Press once to activate the high heat setting (2 indicator lights). Press again to activate the low heat setting (1 indicator light). Press again to deactivate the passenger heated seat.
13. **F**  **Front fan speed control:** Press to manually increase or decrease the fan speed. To return to full automatic control, press AUTO.
14.  **Recirculated air:** Press to activate/deactivate air recirculation in the vehicle cabin. Recirculated air may reduce the amount of time to cool down the interior of the vehicle and may also help reduce undesired odors from reaching the interior of the vehicle. Recirculated air can be engaged manually in any airflow selection except  . Recirculated air may turn off automatically in all airflow selections.
15. **A/C:** Press to activate/deactivate air conditioning. Use with  recirculated air to improve cooling performance and efficiency. Engages automatically in AUTO,  , and  .
16. **OFF:** Outside air is shut out and the climate system is turned off.
17. **Driver temperature control:** Press to increase or decrease the temperature on the driver side of the cabin. Sets the passenger side temperature also when DUAL is disengaged. **Note:** The recommended vehicle cabin setting is between 72°F (22°C) and 75°F (24°C).
  - **Dual temperature control:** Press and hold AUTO to engage/disengage separate passenger side temperature control.
18. **AUTO:** Press to engage full automatic operation, and select the desired temperature using the temperature control. The system will automatically determine fan speed, airflow location, A/C on or off, and outside or recirculated air, to heat or cool the vehicle to reach the desired temperature.



## Climate Controls

19. **REAR:** Press to enable the control located in the rear seat. Press again to turn the auxiliary system off.

### Operating tips

- To reduce fog build up on the windshield during humid weather, place the air flow selector in the  position.
- To reduce humidity build up inside the vehicle: do not drive with the airflow selector in the OFF or with recirculated air engaged.
- Do not put objects under the front seats that will interfere with the airflow to the back seats.
- Remove any snow, ice or leaves from the air intake area at the base of the windshield.
- For maximum cooling performance (MAX A/C):

In AUTO mode, press AUTO control and set to desired temperature.

In manual override control, select  or , A/C and recirculated air  and set the temperature to 60°F (16°C). Set the fan to the highest speed initially, then adjust to maintain passenger comfort.

- To improve the A/C cool down, drive with the windows slightly open for 2–3 minutes after starting the vehicle or until the vehicle has “aired out.”

In extremely cold temperatures, to maximize overall heater performance it is suggested to not operate the auxiliary system (if so equipped) until the engine temperature gauge crosses into the normal operating range.

To aid in side window defogging/demisting in cold weather:

1. Select .
2. Select A/C.
3. Adjust the temperature control to maintain comfort.
4. Set the fan to the highest speed.
5. Direct the outer instrument panel vents towards the side windows.



Do not place objects on top of the instrument panel as these objects may become projectiles in a collision or sudden stop.

## Climate Controls

### AUXILIARY CLIMATE CONTROL (IF EQUIPPED)

1. **Fan speed:** Turn to select the desired fan speed.
2. **Temperature/mode selection:** The distribution of air from the overhead and floor registers is based on the temperature selected. Turn to select for comfort.

To use the rear climate controls, ensure that **REAR** is pressed on the main climate control face.

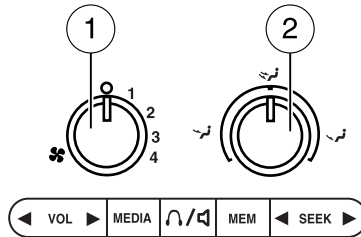

### REAR WINDOW DEFROSTER<sup>R</sup>

The rear defroster control is located on the climate control panel and works to clear the rear window of fog and thin ice. If equipped, the heated outside mirrors also operate with this control to remove snow, mist and ice from the side mirrors.

**Do not use razor blades or other sharp objects to clean the inside of the rear window or to remove decals from the inside of the rear window. This may cause damage to the heated grid lines and will not be covered by your warranty.**

### CABIN AIR FILTER

Your vehicle is equipped with a cabin air filter. The cabin air filter restricts the entry of airborne dust and pollen particles. The filter is located just in front of the windshield under the cowl vent screen on the passenger side of the vehicle.

For replacement intervals regarding your Cabin Air Filter, see your scheduled maintenance guide. For more information regarding your filter, see your authorized dealer.

## Lights

### HEADLAMP CONTROL ☀

- Turns the lamps off.
- P☀ Turns on the parking lamps, instrument panel lamps, license plate lamps and tail lamps.
- ☀ Turns the headlamps on.

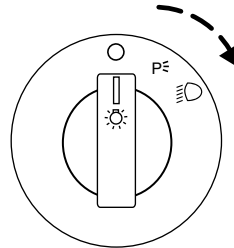

**Note:** Some vehicles may be equipped with a *headlamps on with wipers feature*. In order for this feature to work:

- the ignition must be in run and the front wipers must be on greater than 10 seconds except during a mist wipe or while the wipers are on to clear washer fluid during a wash condition.
- the headlamps and park lamps must be turned off when the ignition is in off or accessory position, or the front wipers are off for more than 30 seconds while the ambient light level is at daytime brightness.

### Autolamp control (if equipped) ☀

The autolamp system provides light sensitive automatic on-off control of the exterior lights normally controlled by the headlamp control.

The autolamp system also keeps the lights on for a fixed period of time after the ignition switch is turned to OFF.

- To turn autolamps on, rotate the control counterclockwise to ☀.
- To turn autolamps off, rotate the control clockwise to ○.

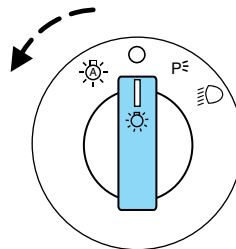

### Autolamps - Programmable exit delay

Programmable exit delay allows the length of the autolamp exit delay to be changed. Once in the programming mode, the headlamps and parklamps will turn on to indicate the start of the time desired.

## Lights

To program the auto lamp exit time delay:

1. Start with the ignition in the OFF position and the headlamp control in the autolamp position.
2. Deselect the auto lamps.
3. Put the ignition in RUN.
4. Put the ignition in OFF.
5. Select the autolamps.
  - **Note:** Steps 2 through 5 must be performed within a 10 second period.
  - At this point, the headlamps and park lamps will turn on.
6. Deselect the auto lamps after the desired auto lamp delay time (maximum of 3 minutes).
  - At this point, the headlamps and park lamps will turn off.

### High beams

Push the lever toward the instrument panel to activate. Pull the lever towards you to deactivate.

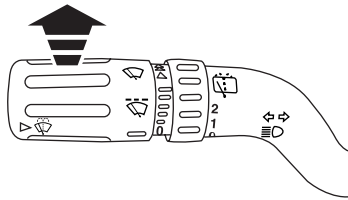

### Flash to pass

Pull toward you slightly to activate and release to deactivate.

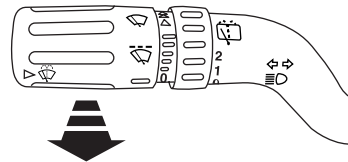

### Daytime running lamps (DRL) (if equipped)

Turns the lowbeam headlamps on with a reduced output. To activate:

- the key must be in the ON position,
- the headlamp control is in the OFF, parking lamps or autolamp position,

## Lights

- and the transmission must be out of PARK.

 Always remember to turn on your headlamps at dusk or during inclement weather. The Daytime Running Light (DRL) System does not activate your tail lamps and generally may not provide adequate lighting during these conditions. Failure to activate your headlamps under these conditions may result in a collision.

### Battery saver

The battery saver will shut off the exterior lamps and interior lamps, except the hazard warning lamps if activated, 10 minutes after the ignition control has been turned off. The battery saver will extend the time-out period for courtesy lamps to 30 minutes if the liftgate is ajar or the dome lamp is on via manual activation using the dome lamp switch or the headlamp switch, whichever is provided. The system will not turn off the parking lamps if the headlamp control is in the PARK position. For interior lights, refer to *Illuminated entry* in the *Locks and Security* chapter.

### PANEL DIMMER CONTROL

Use to adjust the brightness of the instrument panel during headlight and parklamp operation.

- Rotate the thumbwheel from left to right to brighten the instrument panel.
- Rotate the thumbwheel from right to left to dim the instrument panel.

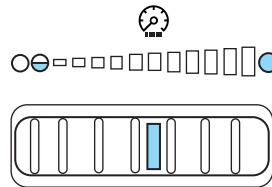

Your vehicle also contains a feature called “sleeping baby mode” — in which the dome lamps will remain off and only the lower lamps will illuminate. This lighting mode can be activated by rotating the thumbwheel to the first left detent position (as denoted by the half filled circle above).

### Domelamp Control

The panel dimmer control also controls the domelamp operation.

- Rotate the thumbwheel fully to the right, past detent to activate the domelamp.
- In order to turn off the domelamp, rotate the thumbwheel to the left.

## Lights

The dome lamp will not illuminate if the control switch is in the OFF position.

### AIMING THE HEADLAMPS

The headlamps on your vehicle are properly aimed at the assembly plant.

If your vehicle has been in an accident the alignment of your headlamps should be checked by your authorized dealer.

You will need a #2 Phillips screwdriver to make the adjustments.

### Vertical aim adjustment

1. Park the vehicle directly in front of a wall or screen on a level surface, approximately 25 feet (7.6 meters) away.

- (1) 8 feet (2.4 meters)
- (2) Center height of lamp to ground
- (3) 25 feet (7.6 meters)
- (4) Horizontal reference line

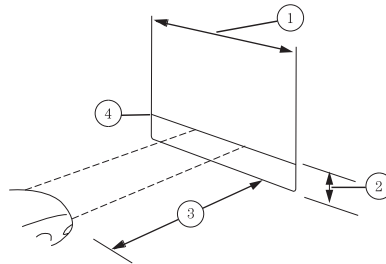

2. Measure the height from the center of your headlamp to the ground and mark an 8 foot (2.4 meter) horizontal reference line on the vertical wall or screen at this height (a piece of masking tape works well). The center of the lamp is marked by a 0.5 mm circle on the headlamp lens.

3. Turn on the low beam headlamps to illuminate the wall or screen and open the hood.

4. On the wall or screen you will observe a light pattern with high intensity flat segments at the top edge of the pattern. If the flat edges are not at the horizontal reference line, the beam will need to be adjusted.

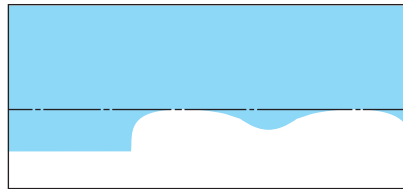



## Lights

5. Locate the vertical adjuster on each headlamp, then use a # 2 Phillips screwdriver to turn the adjuster either counterclockwise (to adjust up) or clockwise (to adjust down) positioning the horizontal edge of the high intensity light on the horizontal reference line.

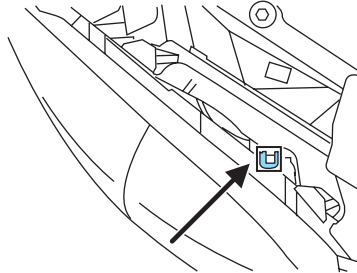

6. HORIZONTAL AIM IS NOT REQUIRED FOR THIS VEHICLE AND IS NON-ADJUSTABLE.

7. Close the hood and turn off the lamps.

### TURN SIGNAL CONTROL ⇄

- Push down to activate the left turn signal.
- Push up to activate the right turn signal.

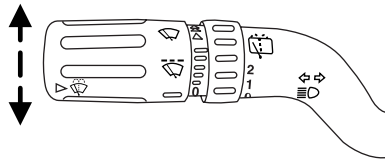

The cornering lamps feature (if equipped) automatically illuminates the left or right cornering lamps, located at the front corners of the vehicle, when the left or right turn signal, is activated. Cornering lamps are to provide better visibility of the area where the driver intends to turn.

### INTERIOR LAMPS

The interior lights illuminate when:

- any door is opened (and the operation switch is in the middle position).
- the instrument panel dimmer switch is moved to the passenger side position (right position).
- any of the remote entry controls are pressed and the ignition is OFF (and the operation switch is in the middle position).

## Lights

### Map lamps (if equipped)

The map lamps and controls are located on the center overhead console. Press the raised portion on each lens to activate the lamps.

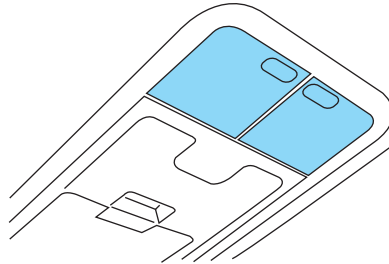

### Second row & third row dome and map lamps (if equipped)

The second row dome and map lamps are located overhead, above the second row passenger seats.

The dome lamp will stay on if the panel dimmer control is moved to the passenger side position. When the control is in the middle position, the lamp will only come on when a door is opened. If the control is moved to the driver's side position, the lamp will not come on at all.

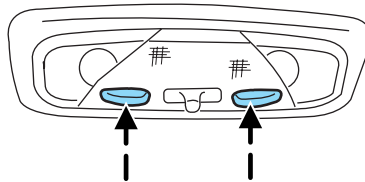

The dome lamp will illuminate whenever a front door is opened. If either front door has been opened from the outside, the lamp will remain on for 20 seconds after the door is shut. If any other door has been opened from the inside, the lamp will shut off immediately after the door is closed.

To activate the map lamps, press the control on either side of the center operation switch.

### Dome lamps (if equipped)

The front dome lamp is located overhead between the driver and passenger seats.

The dome lamp will stay on if the panel dimmer control is moved to the passenger side position. When the control is in the middle position, the lamp will only come on when a

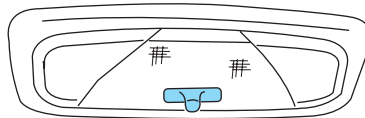

## Lights

door is opened. If the control is moved to the driver's side position, the lamp will not come on at all.

The dome lamp will illuminate whenever a front door is opened. If either front door has been opened from the outside, the lamp will remain on for 20 seconds after the door is shut. If any other door has been opened from the inside, the lamp will shut off immediately after the door is closed.

### Cargo lamp

The cargo lamp will stay on if the control is moved to the driver side position. When the control is in the middle position, the lamp will only come on when a door is opened. If the control is moved to the passenger's side position, the lamp will not come on at all.

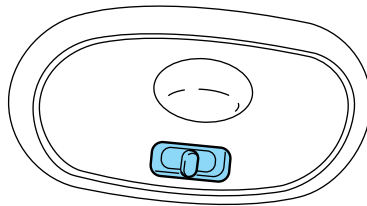

With the ignition key in the ACCESSORY or ON position, the rear cargo lamp can be turned ON or OFF by sliding the control.

### BULB REPLACEMENT

#### Headlamp Condensation

The headlamps are vented to equalize pressure. When moist air enters the headlamp(s) through the vents, there is a possibility that condensation can occur. This condensation is normal and will clear within 45 minutes of headlamp operation.

#### Replacing exterior bulbs

Check the operation of all the bulbs frequently.

#### Using the right bulbs

Replacement bulbs are specified in the chart below. Headlamp bulbs must be marked with an authorized "D.O.T." for North America and an "E" for Europe to ensure lamp performance, light brightness and pattern and safe visibility. The correct bulbs will not damage the lamp assembly or void the lamp assembly warranty and will provide quality bulb burn time.

## Lights

Function	Trade Number
Front park/turn lamps	3457AK (amber)
Front sidemarkers lamp	904NA (amber)
Cornering lamps	3156K
Auxiliary parking lamps	912
Headlamps	H13
Rear license plate lamps	W5WL
High-mount brake lamp	LED (see dealer)
Rear tail/stop/turn lamps	4157K or 3157K
Backup lamps	3156K
Dome lamp (front row)	10W sofitte
Cargo lamp	10W sofitte
Map lamps	H6W
Dome lamp (third row)	10W sofitte
Map lamp (overhead console)	906
Stepwell lamp	T-562
Front seat footwell	194
Front door mounted courtesy lamp	168
Visor vanity lamp - Slide on Rail system (SOR)	37
All replacement bulbs are clear in color except where noted.	
To replace all instrument panel lights - see your authorized dealer.	

### Replacing headlamp bulbs

To remove the headlamp bulb:

1. Make sure headlamp switch is in the OFF position, then open the hood.

## Lights

2. Remove the two retainer pins to release the headlamp assembly and pull headlamp assembly forward to expose the back of the bulb.

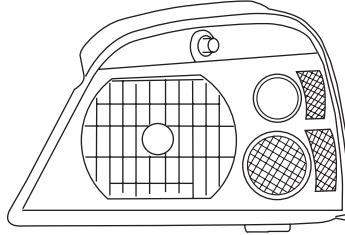

3. Disconnect the electrical connector from the bulb by pulling rearward and unlock the bulb by rotating it counterclockwise.

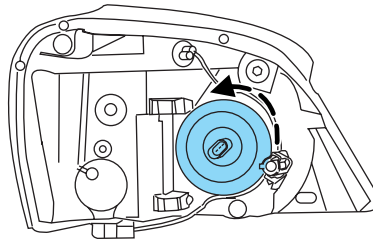

Handle a halogen headlamp bulb carefully and keep out of children's reach. Grasp the bulb only by its plastic base and do not touch the glass. The oil from your hand could cause the bulb to break the next time the headlamps are operated.

Install the new bulb(s) in reverse order.

### ***Replacing front parking/turn/sidemarkers signal bulbs***

1. Make sure the headlamp switch is in the OFF position and open the hood.
2. Remove the two headlamp retaining pins to release the headlamp assembly, then pull the headlamp assembly forward to expose the bulb socket.

## Lights

3. To remove the *side marker* bulb, turn the bulb socket counterclockwise, and pull the bulb straight out of the socket.

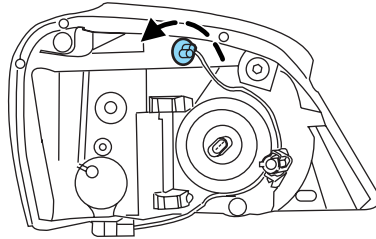

4. To remove the *parking/turn* bulb, turn the socket on the bottom of the headlamp assembly counterclockwise and pull the bulb straight out of the socket.

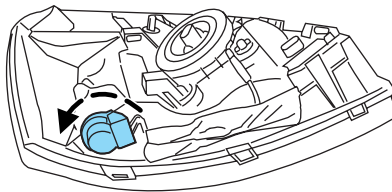

Install the new bulb(s) in reverse order.

### **Replacing tail lamp/backup/turn lamp bulbs**

1. Make sure the headlamp switch is in the OFF position and open the liftgate to expose the tail lamp assembly, then remove the retaining screws for the lamp assembly.

2. Carefully remove the lamp assembly.

3. Rotate bulb socket counterclockwise and remove from lamp assembly.

4. Pull bulb straight out of socket and push in new bulb.

Install the new bulb(s) in reverse order.

### **Replacing high-mount brakelamp bulbs**

For bulb replacement, see your authorized dealer.

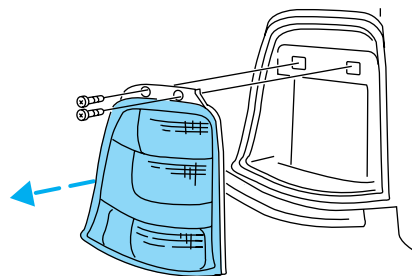

## Lights

### **Replacing license plate lamp bulb**

The license plate bulbs are located in the license plate housing assembly on the liftgate. To change the license plate bulbs:

1. Make sure the headlamp switch is in the OFF position.
2. Remove the license lamp screw from the assembly.
3. Pull the lamp down and twist the bulb socket counterclockwise. Remove the bulb socket from the lamp.
4. Pull out the old bulb and push in the new bulb.

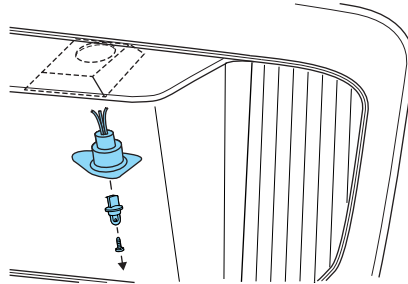

5. Install the bulb socket in the lamp assembly by turning it clockwise.
6. Install the lamp assembly and secure it with the retaining screw.

### **Replacing supplemental park lamp or cornering lamp bulbs (if equipped)**

The supplemental park or cornering lamp is located on the front fascia, below the bumper and headlamps.

1. Make sure the park lamp switch is in the OFF position and then remove the bulb socket from the supplemental parking lamp by turning counterclockwise.
2. Disconnect the electrical connector.

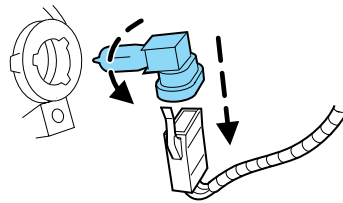

Install the new bulb in reverse order.

## Driver Controls

### MULTI-FUNCTION LEVER

**Windshield wiper:** Rotate the end of the control away from you to increase the speed of the wipers; rotate towards you to decrease the speed of the wipers.

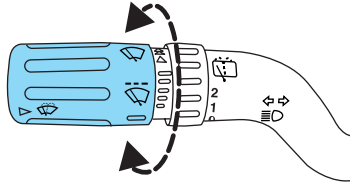

**Windshield washer:** Push the end of the stalk:

- briefly: causes a single swipe of the wipers without washer fluid.
- a quick push and hold: the wipers will swipe three times with washer fluid.
- a long push and hold: the wipers and washer fluid will be activated for up to ten seconds.

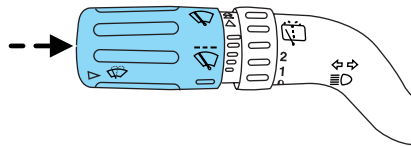

**Note:** Do not operate the washer when the washer reservoir is empty. This may cause the washer pump to overheat. Check the washer fluid level frequently. Do not operate the wipers when the windshield is dry. This may scratch the glass, damage the wiper blades and cause the wiper motor to burn out. Before operating the wiper on a dry windshield, always use the windshield washer. In freezing weather, be sure the wiper blades are not frozen to the windshield before operating the wipers.

### Rear window wiper/washer controls

For rear wiper operation, rotate the rear window wiper and washer control to the desired position. Select:

INT 2 — One to three second interval rear wiper.

INT 1 — Ten second interval rear wiper.

OFF — Rear wiper and washer off.

For rear wash cycle, rotate (and hold as desired) the rear wiper/washer control to either  position.

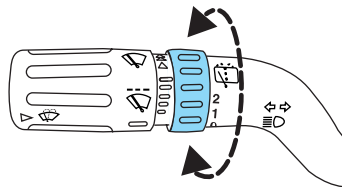



## Driver Controls

From either position, the control will automatically return to the INT2 or OFF position.

### TILT STEERING WHEEL

To adjust the steering wheel:

1. Pull and hold the steering wheel release control toward you.
2. Move the steering wheel up or down until you find the desired location.
3. Release the steering wheel release control. This will lock the steering wheel in position.

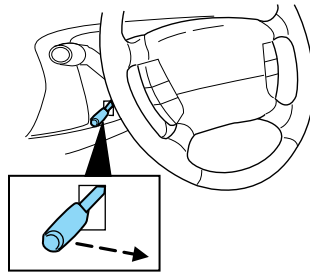

Never adjust the steering wheel when the vehicle is moving.

### ILLUMINATED VISOR MIRROR (IF EQUIPPED)

Lift the mirror cover to turn on the visor mirror lamp.

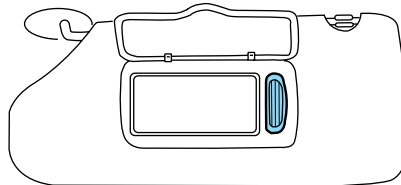

### Slide on rod feature

Rotate the visor towards the side window and extend it rearward for additional sunlight coverage.

**Note:** To stow the visor back into the headliner, visor must be retracted before moving it back towards the windshield.

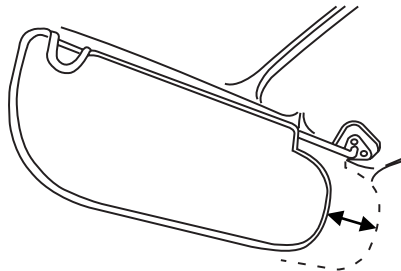

## Driver Controls

### OVERHEAD CONSOLE (IF EQUIPPED)

The appearance of your vehicle's overhead console will vary according to your option package.

#### Conversation mirror

The conversation mirror allows the driver to view the rear seating area.



This does not replace the rear view mirror.

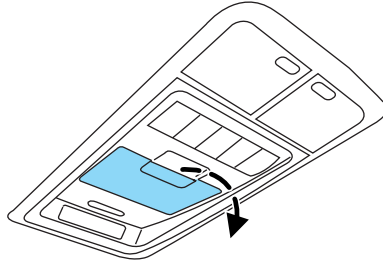

#### Electronic compass/temperature display (if equipped)

The overhead console may have an electronic compass and outside air temperature display. The compass heading and outside air temperature are displayed together - side by side.

The display, as a whole, can be turned on or off by pressing the momentary push-button on the overhead console. When the vehicle is turned off, the electronics display will remember the last display state.

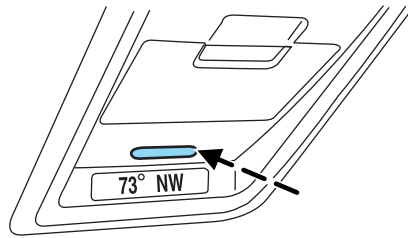

#### Outside air temperature

The temperature can be displayed in either Centigrade or Fahrenheit.

This is controlled via the Message Center. Please refer to the *Message Center* in this chapter to change from English to metric. The ignition key must be in the ON or ACCESSORY position.

If the outside temperature falls below 3°C (38°F), the display will alternate from "ICE" to the outside temperature at a two second rate for one minute.

#### Compass

The vehicle heading is displayed as one of N, NE, E, SE, S, SW, W and NW.

The compass reading may be affected when you drive near large buildings, bridges, power lines and powerful broadcast antenna. Magnetic

## Driver Controls

or metallic objects placed in or on the vehicle may also affect compass accuracy. Adjustments may need to be made to the zone and calibration of the compass.

### **Zone variation mode**

1. Determine which magnetic zone you are in by referring to the zone map.
2. Turn the ignition to the ON position.

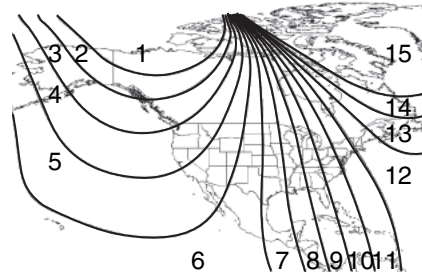

3. Press and hold the momentary push-button for approximately 4 seconds, until VAR is displayed, then release it. (Pressing the momentary push-button for 8 seconds de-calibrates the compass—see *Compass Calibration Mode*).

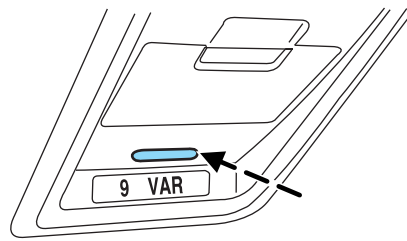

4. Press the button to increment the VAR number to the desired VAR number. Wait 5 seconds without button activity and the compass will return to the heading mode.

**Note:** If there is no button activity for 5 seconds, the compass writes the displayed zone VAR number to memory and exits Zone Variation Mode

## Driver Controls

### Compass calibration mode

1. Press the momentary push button and hold it for more than 8 seconds. After 8 seconds, CAL is displayed, then release it.

**Note:** After button release CAL will be displayed with a heading. The compass is now de-calibrated and enters the Initial AutoCal Mode.

2. Drive the vehicle in a tight circle in a magnetically clean area such as an open parking lot. Drive at a rate not faster than 15 seconds per circle 5 mph (8km/h).

**Note:** Look for a parking lot away from buildings, light posts, manhole covers, sewer and drainage grates and other metallic objects. Some magnetic objects may be hidden underground. Look for signs of underground utilities, water mains or other industrial structures. The parking lot should be level and have a smooth surface. Blacktop is preferred over cement as a cement surface often contains iron reinforcing bars or metallic mesh that could interfere with the calibration process.

- The CAL indicator will turn off when the calibration process is complete, leaving the compass heading on the display.

**Note:** This process normally takes about 1½ circles but may take longer if magnetic noise is present or if the circles are driven too fast.

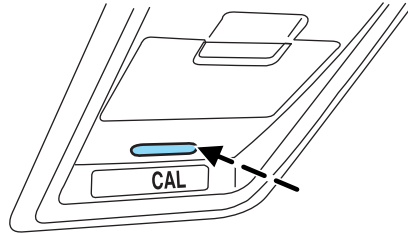

### SLIDING DOOR OPERATION

#### Manual door operation

If equipped with a Power Sliding Door (PSD), turn the Power Door Lockout control on the overhead console to the OFF position. Refer to the *Disabling power operation of the PSD* section in this chapter for more information.

**Note:** Before unlatching the left side door, verify that the fuel fill door is closed. The left hand door will not open if the fuel door is open.

Slide the door carefully in a controlled manner to the full open position. At the end of travel, firmly push the door against the bump stop to engage the hold open mechanism to restrain the door. When operating the door on a gradient, special care should be taken to manually control the opening and closing speed of the door.

## Driver Controls



If the door is allowed to slide open or closed unrestrained, personal injury or damage to the door could result.

When closing the sliding door, keep the head, hands and other body parts of vehicle occupants out of the path of the closing door. Slide the door closed in a careful, controlled manner.



When closing the sliding doors, you should verify they are free of obstructions and ensure that children and/or pets are not in the proximity of the sliding door openings. Injury could result if body parts are caught or pinched in an uncontrolled sliding door.

### Manual door operation when vehicle is stopped or parked on a downhill grade

In some cases it may be necessary to have someone hold the door while rear seat passengers are entering or exiting the vehicle. The hold open mechanism will restrain the door open when the vehicle is parked on moderate downhill grades. **On more severe grades, the operator should ensure that the open door is stable and secure against the stop, before allowing passengers to enter or exit the vehicle or before loading/unloading cargo.**

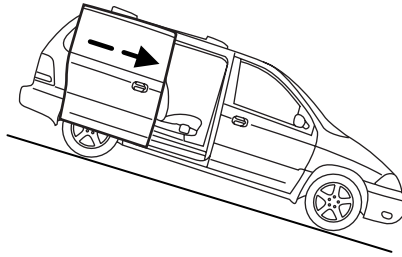

Do not operate vehicle with the door in the open position. Abrupt vehicle acceleration or deceleration could cause the door to move suddenly and could result in personal injury or damage to the door.



If the vehicle is parked on a downhill grade, the door could slam shut and could result in injury or damage to the door. Ensure that the open door is secure against the stop before allowing passengers to enter or exit the vehicle.

## Driver Controls

### **Power Sliding Door (PSD) (if equipped)**

With this option, you can open and close the sliding door(s) with the following controls inside your vehicle.

- overhead console button
- remote entry transmitter button
- second row passenger control switch
- inside and outside release handle

### **Opening and closing the PSD**

The PSD will operate without the key in the ignition. The transaxle must be in PARK to open the PSD, when the key is in the ignition and turned to the ON position.

The sliding door must be unlocked for the PSD to power open from the rear trim switches and the inside or outside PSD handles. The fuel filler door must be closed in order to avoid damage to it when the left sliding door is opened.

The Power Door Lockout Control is located in the overhead console.

With the control in the OFF position, power operation is disabled from both PSD handles and from both second row passenger

switches. The overhead console switch and remote entry transmitter will operate the power doors regardless of the position of the lockout switch.



When opening or closing the sliding doors, you should verify they are free of obstructions and ensure that children and/or pets are not in the proximity of the sliding door openings. Injury could result if body parts are caught or pinched in an uncontrolled sliding door.

### **To power open or close the PSD from the Overhead console:**

Push and release the overhead console right or left hand control. Pressing this control will also simultaneously unlock all doors.



## Driver Controls

### To power open or close the PSD from the second row passenger control switch:

- Ensure that the PSD is unlocked, using the remote entry transmitter or power door unlock. Refer to *Remote Entry System* in the *Locks and security* chapter.
- Push and release the right or left hand second row passenger control. The control(s) are located on the trim panel in front of the sliding door.

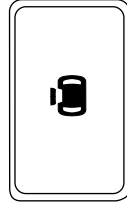

### To power open the PSD with the inside or outside release handle:

- Ensure that the PSD is unlocked, using the remote entry transmitter or power door unlock. Refer to *Remote Entry System* in the *Locks and security* chapter.
- Manually pull the inside or outside sliding door handle to engage the power assist feature. Release the handle as soon as the PSD begins to power open.

### To power close the PSD with the inside or outside release handle:

- Manually pull the door about 6 inches in the desired direction of travel. The power door assist will take over and complete the open or close operation.

Pressing any of the switches, overhead console, second row passenger, or remote entry transmitter while the door is moving will cause the door to either reverse direction or stop depending on the position and direction of movement of the door.

### To power open or close the PSD with the remote entry transmitter:

Refer to the *Remote entry system* section in this chapter. Operating the transmitter will also simultaneously unlock the doors.

### **Disabling PSD power operation**

Pressing the Power Door Lockout Control to the OFF position prevents power operation of the PSD using the rear seat control(s), inside or outside handle or by manually moving the door. With the PSD rear controls disabled, the door(s) can be opened manually with the inside or outside handles. With the Power Door Lockout control in the OFF position, the overhead console right and left hand controls and the Remote Entry System remain functional. Disabling the PSD may be

## Driver Controls

desirable to prevent power operation of the door by rear seat passengers or if manual operation of the door is desired or necessary when the vehicle is stopped or parked on a steep downhill grade.

Refer to the *Manual operation of the sliding door* section in this chapter for more information.

With the child safety lock engaged, the inside handle operation will always be disabled regardless of the position of the Power Door Lockout control. Refer to the *Sliding door child safety lock* section in this chapter for more information. The trim mounted rear seat control and the outside handle remain functional for power operation.

### **Safety/Obstructions**

If anything obstructs the Power Sliding Door while it is power closing or opening, the door will automatically reverse or stop depending on the position of the door, provided it meets sufficient resistance.

### **Resetting the PSD**

The power sliding door may operate incorrectly or not at all because of the following conditions:

- a low voltage or dead battery
- the door is left opened for more than 6 hours
- the battery is disconnected
- the PSD Passenger compartment fuse panel fuse (fuse #11) is removed or blown. Refer to *Fuses and relays* in the *Roadside Emergencies* chapter.

If any of the above conditions has occurred, perform the following steps to reset the PSD so that electronics can relearn the open and closed positions:

1. Check to see if PSD is securely closed.
2. Make sure the gearshift is in (P) Park.
3. Push the PSD control on the overhead console to open the door.
4. Wait five (5) seconds and close the door by pressing the PSD control on the overhead console.
5. Wait five (5) seconds and repeat Steps 3 and 4 then go on to Step 6.
6. Repeat Steps 3–5 for opposite door.

If the door still does not operate correctly:

7. Ensure the ignition is in the OFF position



## Driver Controls

8. Remove the PSD fuse (fuse #11) from the passenger fuse panel and leave it out for thirty (30) seconds. Refer to the chapter on Fuses and Relays. Refer to *Fuses and relays* in the *Roadside emergencies* chapter.

9. Reinstall the fuse and wait ten (10) seconds.

10. Repeat Steps 1–6 above.

If the door still does not operate correctly, see your dealer for service.

### **Sliding Door Child Safety Lock**

Your vehicle is equipped with a sliding door child safety lock that helps prevent passengers from operating the sliding door by using the inside door handle, refer to the *Childproof door locks* in the *Locks and security* chapter.

To open the sliding door when the child safety lock is on:

- Unlock the sliding door and open the door from the outside.
- Press the right or left hand control on the overhead console or the remote to open the door.
- The second row passenger switch will still be functional to open the door. To prevent the second row passenger from operating the PSD, turn the Power Door Lockout control to the OFF position.

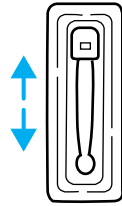

### **CENTER CONSOLE (IF EQUIPPED)**

Your vehicle may be equipped with a utility compartment.

### **INSTRUMENT PANEL STORAGE COMPARTMENT**

The storage compartment may be used to secure sunglasses or similar sized objects. Press the control to open the storage compartment.

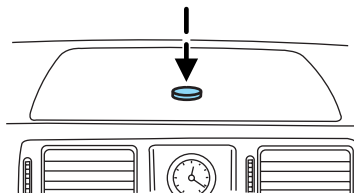

## Driver Controls

### CLOCK (IF EQUIPPED)

Press the right (+) control to move the time display forwards.

Press the left (-) control to move the time display backwards.

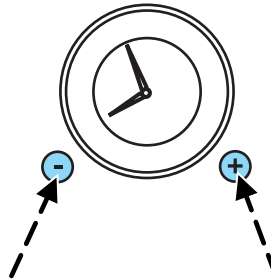

### AUXILIARY POWER POINT (12VDC)

**Power outlets are designed for accessory plugs only. Do not insert any other object in the power outlet as this will damage the outlet and blow the fuse. Do not hang any type of accessory or accessory bracket from the plug. Improper use of the power outlet can cause damage not covered by your warranty.**

Do not use the power point for operating the cigarette lighter element (if equipped).

To prevent the fuse from being blown, do not use the power point(s) over the vehicle capacity of 12 VDC/180W.

To prevent the battery from being discharged, do not use the power point longer than necessary when the engine is not running.

Always keep the power point caps closed when not being used.

There are up to three auxiliary power points in the following locations:

- Located on the instrument panel.

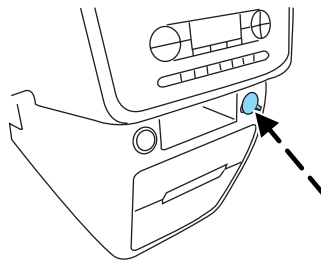

## Driver Controls

- Located next to the second row seat.

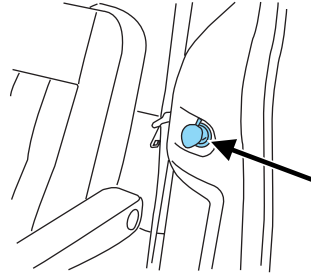

- Located on the right trim panel in the rear cargo area.

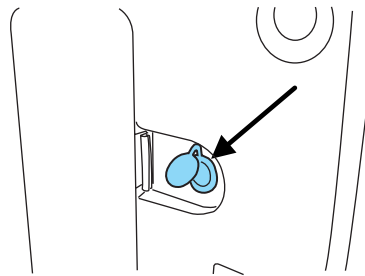

### **Cigar/Cigarette lighter (if equipped)**

Do not plug optional electrical accessories into the cigarette lighter socket.

Do not hold the lighter in with your hand while it is heating, this will damage the lighter element and socket. The lighter will be released from its heating position when it is ready to be used.

Improper use of the lighter can cause damage not covered by your warranty.

### **POWER WINDOWS**



Do not leave children unattended in the vehicle and do not let children play with the power windows. They may seriously injure themselves.



When closing the power windows, you should verify they are free of obstructions and ensure that children and/or pets are not in the proximity of the window openings.

## Driver Controls

Press and pull the window switches to open and close windows.

- Push down (to the first detent) and hold the switch to open.
- Pull up (to the first detent) and hold the switch to close.

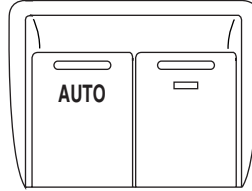

### One touch down

Allows the driver's window to open fully without holding the control down. Push the switch completely down to the second detent and release quickly. The window will open fully. Momentarily press the switch to any position to stop the window operation.

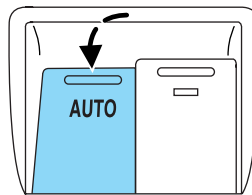

### Accessory delay

With accessory delay, the window switches and radio may be used for up to ten minutes after the ignition switch is turned to the OFF position or until any door or trunk is opened.

### Power vent windows



Do not leave children unattended in the vehicle and do not let children play with the power vent windows. They may seriously injure themselves.



When closing the power vent windows, you should verify they are free of obstructions and ensure that children and/or pets are not in the proximity of the window openings.

## Driver Controls

The power vent windows are operated by a single switch located on the instrument panel. Press and hold the bottom of the switch to open or the top of the switch to close both vent windows.

A sound will be heard when opening and closing the vent windows. This is a normal noise that informs you the windows are operating.

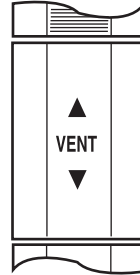

### AUTOMATIC DIMMING INSIDE REAR VIEW MIRROR (IF EQUIPPED)

Your vehicle may be equipped with an inside rear view mirror with an auto-dimming function. The electronic day/night mirror will change from the normal (high reflective) state to the non-glare (darkened) state when bright lights (glare) reach the mirror. When the mirror detects bright light from behind the vehicle, it will automatically adjust (darken) to minimize glare.

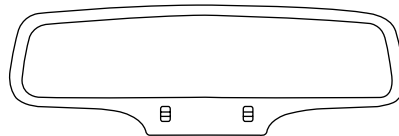

The mirror will automatically return to the normal state whenever the vehicle is placed in R (Reverse) to ensure a bright clear view when backing up.

Do not block the sensor on the backside of the inside rear view mirror since this may impair proper mirror performance.

### EXTERIOR MIRRORS

#### Power side view mirrors

To adjust your mirrors:

1. Rotate the control clockwise to adjust the right mirror and rotate the control counterclockwise to adjust the left mirror.
2. Move the control in the direction you wish to tilt the mirror.
3. Return to the center position to lock mirrors in place.



## Driver Controls

### Heated outside mirrors (if equipped)

Both mirrors are heated automatically to remove ice, mist and fog when the rear window defrost is activated.

**Do not remove ice from the mirrors with a scraper or attempt to readjust the mirror glass if it is frozen in place.**

**These actions could cause damage to the glass and mirrors.**

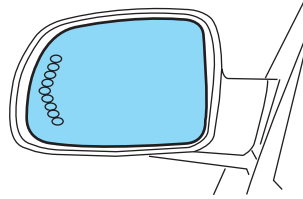

### Signal indicator mirrors (if equipped)

When the turn signal is activated, the appropriate mirror will show a blinking yellow arrow. When the park lamps are on, the blinking arrow will be dimmer.

The arrow provides an additional warning to other drivers that your vehicle is about to turn.

When the sliding door is open, the indicator in the appropriate mirror will flash indicating people may be entering/exiting the vehicle.

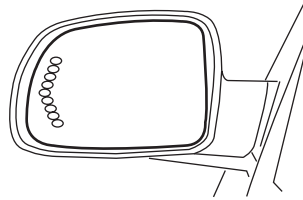

### Fold-away mirrors

Fold the side mirrors in carefully when driving through a narrow space, like an automatic car wash.

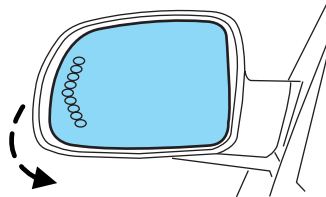

## Driver Controls

### POWER ADJUSTABLE FOOT PEDALS (IF EQUIPPED)

The accelerator and brake pedal should only be adjusted when the vehicle is stopped and the gearshift lever is in the P (Park) position.

Press and hold the rocker control to adjust accelerator and brake pedal toward you or away from you.

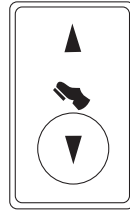

The adjustment allows for approximately 2.8 inches (73 mm) of maximum travel.



Never adjust the accelerator and brake pedal with feet on the pedals while the vehicle is moving.

### SPEED CONTROL (IF EQUIPPED)

With speed control set, you can maintain a speed of 30 mph (48 km/h) or more without keeping your foot on the accelerator pedal. Speed control does not work at speeds below 30 mph (48 km/h).

If your vehicle is equipped with AdvanceTrac<sup>™</sup> system, the speed control will automatically disengage when the road conditions change. When driving conditions permit you can return to speed control by pressing RESUME on the speed control. For more information on the AdvanceTrac<sup>™</sup> system see *AdvanceTrac<sup>™</sup> Stability Enhancement System* section in the *Driving* chapter.



Do not use the speed control in heavy traffic or on roads that are winding, slippery or unpaved.

### Setting speed control

The controls for using your speed control are located on the steering wheel for your convenience.

1. Press the ON control and release it.
2. Accelerate to the desired speed.

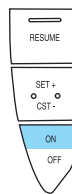

## Driver Controls

3. Press the SET + control and release it.
4. Take your foot off the accelerator pedal.
5. The indicator  light on the instrument cluster will turn on.



### Note:

- Vehicle speed may vary momentarily when driving up and down a steep hill.
- If the vehicle speed increases above the set speed on a downhill, you may want to apply the brakes to reduce the speed.
- If the vehicle speed decreases more than 10 mph (16 km/h) below your set speed on an uphill, your speed control will disengage.

### Disengaging speed control

To disengage the speed control:

- Depress the brake pedal

Disengaging the speed control will not erase previous set speed.

### Resuming a set speed

Press the RESUME control and release it. This will automatically return the vehicle to the previously set speed. The RESUME control will not work if the vehicle speed is not faster than 30 mph (48 km/h).

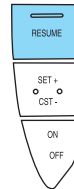

### Increasing speed while using speed control

There are two ways to set a higher speed:

- Press and hold the SET + control until you get to the desired speed, then release the control. You can also use the SET + control to operate the Tap-Up function. Press and release this control to increase the vehicle set speed in small amounts by 1 mph (1.6 km/h).





## Driver Controls

- Use the accelerator pedal to get to the desired speed. When the vehicle reaches that speed press and release the SET + control.

### **Reducing speed while using speed control**

There are two ways to reduce a set speed:

- Press and hold the CST - control until you get to the desired speed, then release the control. You can also use the CST - control to operate the Tap-Down function. Press and release this control to decrease the vehicle set speed in small amounts by 1 mph (1.6 km/h).
- Depress the brake pedal until the desired vehicle speed is reached, press the SET + control.

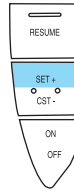
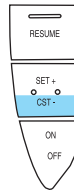

### **Turning off speed control**

There are two ways to turn off the speed control:

- Depress the brake pedal. This will not erase your vehicle's previously set speed.
- Press the speed control OFF control.

**Note:** When you turn off the speed control or the ignition, your speed control set speed memory is erased.

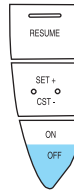

## Driver Controls

### STEERING WHEEL CONTROLS (IF EQUIPPED)

#### Radio control features

- Press MEDIA to select AM, FM1, FM2, TAPE or CD (if equipped).



In Radio mode:

- Press SEEK to access the next/previous strong station.

In Tape mode:

- Press SEEK to listen to the next/previous selection on the tape.



In CD mode:

- Press SEEK to listen to the next/previous track on the disc.

In any mode:

- Press VOL up or down to adjust the volume.
- Press MUTE to mute the volume.



### HOMELINK® WIRELESS CONTROL SYSTEM (IF EQUIPPED)

The HomeLink® Wireless Control System, located on the driver's visor, provides a convenient way to replace up to three hand-held transmitters with a single built-in device. This feature will learn the radio frequency codes of most transmitters to operate garage doors, entry gate operators, security systems, entry door locks, and home or office lighting.

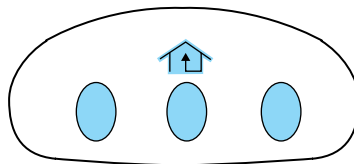

## Driver Controls



When programming your HomeLink® Wireless Control System to a garage door or gate, be sure that people and objects are out of the way to prevent potential harm or damage.

Do not use the HomeLink® Wireless Control System with any garage door opener that lacks safety stop and reverse features as required by U.S. federal safety standards (this includes any garage door opener model manufactured before April 1, 1982). A garage door which cannot detect an object, signaling the door to stop and reverse, does not meet current U.S. federal safety standards. For more information, contact HomeLink® at: **www.homelink.com** or **1-800-355-3515**.

Retain the original transmitter for use in other vehicles as well as for future programming procedures (i.e. new HomeLink® equipped vehicle purchase). It is also suggested that upon the sale of the vehicle, the programmed HomeLink® buttons be erased for security purposes, refer to *Programming* in this section.

### Programming

#### **Do not program HomeLink® with the vehicle parked in the garage.**

**Note:** Your vehicle may require the ignition switch to be turned to the ACC position for programming and/or operation of the HomeLink®. It is also recommended that a new battery be placed in the hand-held transmitter of the device being programmed to HomeLink® for quicker training and accurate transmission of the radio-frequency signal.

1. Press and hold the two outside buttons releasing only when the indicator light begins to flash after 20 seconds. **Do not** repeat Step 1 to program additional hand-held transmitters to the remaining two HomeLink® buttons. This will erase previously programmed hand-held transmitter signals into HomeLink®.

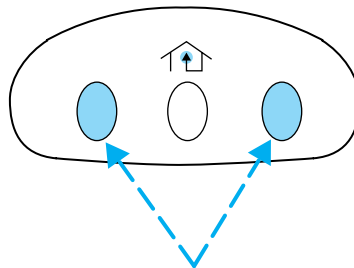

2. Position the end of your hand-held transmitter 1–3 inches (2–8 cm) away from the HomeLink® button you wish to program (located on your visor) while keeping the indicator light in view.

## Driver Controls

3. Simultaneously press and hold both the HomeLink® and hand-held transmitter button. **Do not release the buttons until Step 4 has been completed.**

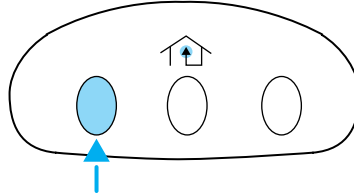

Some entry gates and garage door openers may require you to replace Step 3 with procedures noted in the “Gate Operator and Canadian Programming” in this section for Canadian residents.

4. The indicator light will flash slowly and then rapidly. Release both buttons when the indicator light flashes rapidly. (The rapid flashing light indicates acceptance of the hand-held transmitters’ radio frequency signals.)

5. Press and hold the just-trained HomeLink® button and observe the indicator light. If the light is constant, programming is complete and your device should activate when the HomeLink® button is pressed and released. **Note:** To program the remaining two HomeLink® buttons, begin with Step 2 in the “Programming” section — **do not** repeat Step 1.

**Note:** If the indicator light blinks rapidly for two seconds and then turns to a continuous red, proceed with Steps 6 through 8 to complete programming of a rolling code equipped device.

6. At the garage door opener receiver (motor-head unit) in the garage, locate the “learn” or “smart” button (usually near where the hanging antenna wire is attached to the unit).

7. Press and release the “learn” or “smart” button. (The name and color of the button may vary by manufacturer.)

**Note:** There are 30 seconds in which to initiate Step 8.

8. Return to the vehicle and firmly press, hold for two seconds and release the HomeLink® button. Repeat the press/hold/release sequence again, and, depending on the brand of the garage door opener (or other rolling code equipped device), repeat this sequence a third time to complete the programming.

HomeLink® should now activate your rolling code equipped device. To program additional HomeLink® buttons begin with Step 2 in the “Programming” section. For questions or comments, please contact HomeLink at **www.homelink.com** or **1-800-355-3515**.

## Driver Controls

### Gate Operator & Canadian Programming

During programming, your hand-held transmitter may automatically stop transmitting — not allowing enough time for HomeLink® to accept the signal from the hand-held transmitter.

After completing Steps 1 and 2 outlined in the “Programming” section, replace Step 3 with the following:

**Note:** If programming a garage door opener or gate operator, it is advised to unplug the device during the “cycling” process to prevent overheating.

- Continue to press and hold the HomeLink® button (note Step 3 in the “Programming” section) while you press and release — **every two seconds** (“cycle”) your hand-held transmitter until the frequency signal has been accepted by the HomeLink®. The indicator light will flash slowly and then rapidly after HomeLink® accepts the radio frequency signal.
- Proceed with Step 4 in the “Programming” section.

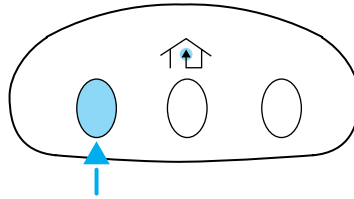

### Operating the HomeLink® Wireless Control System

To operate, simply press and release the appropriate HomeLink® button. Activation will now occur for the trained product (garage door, gate operator, security system, entry door lock, or home or office lighting etc.). For convenience, the hand-held transmitter of the device

may also be used at any time. In the event that there are still programming difficulties, contact HomeLink® at [www.homelink.com](http://www.homelink.com) or **1-800-355-3515**.

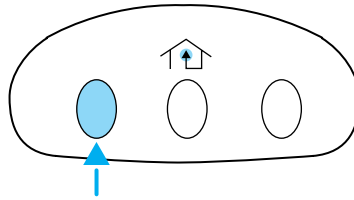

## Driver Controls

### Erasing HomeLink® buttons

To erase the three programmed buttons (individual buttons cannot be erased):

- Press and hold the two outer HomeLink® buttons until the indicator light begins to flash—after 20 seconds. Release both buttons. Do not hold for longer than 30 seconds.

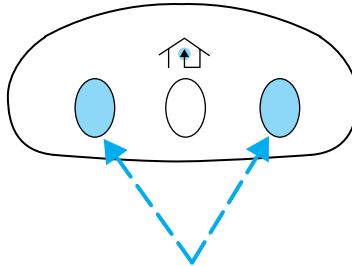

HomeLink® is now in the train (or learning) mode and can be programmed at any time beginning with Step 2 in the “Programming” section.

### Reprogramming a single HomeLink® button

To program a device to HomeLink® using a HomeLink® button previously trained, follow these steps:

1. Press and hold the desired HomeLink® button. **Do NOT** release the button.
2. The indicator light will begin to flash after 20 seconds. Without releasing the HomeLink® button, follow Step 2 in the “Programming” section.

For questions or comments, contact HomeLink® at [www.homelink.com](http://www.homelink.com) or **1-800-355-3515**.

### MESSAGE CENTER (IF EQUIPPED)

With the ignition in the ON position, the message center, located on your instrument cluster, displays important vehicle information through a constant monitor of vehicle systems. You may select display features on the message center for a display of status preceded by a brief indicator chime. The system will also notify you of potential vehicle problems with a display of system warnings followed by an indicator chime.



### Selectable features

#### Reset

Press this control to select and reset functions shown in the INFO menu and SETUP menu.

## Driver Controls

### Info menu

This control displays the following options:

- Odometer
- Distance to Empty
- Trip Odometer
- Average Fuel Economy
- Trip Elapsed Drive Time
- Display On/Off (top two lines)

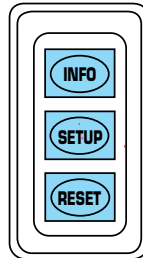

### Odometer/Trip Odometer

Refer to *Gauges in the Instrument Cluster* chapter.

### Distance to empty (DTE)

Selecting this function from the INFO menu estimates approximately how far you can drive with the fuel remaining in your tank under normal driving conditions.

Remember to turn the ignition OFF when refueling to allow this feature to correctly detect the added fuel.

DTE is calculated using a running average fuel economy, which is based on your recent driving history of 500 miles (800 km). This value is not the same as the average fuel economy display. The running average fuel economy is reinitialized to a factory default value if the battery is disconnected.

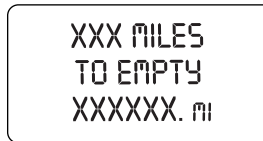

### Average Fuel Economy (AFE)

Select this function from the INFO menu to display your average fuel economy in 100 miles/gallon or liters/100 km.

If you calculate your average fuel economy by dividing gallons of fuel used by 100 miles traveled (kilometers traveled by liters used), your figure may be different than displayed for the following reasons:

- your vehicle was not perfectly level during fill-up
- differences in the automatic shut-off points on the fuel pumps at service stations

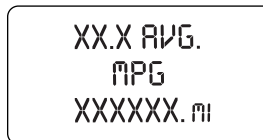

## Driver Controls

- variations in top-off procedure from one fill-up to another
  - rounding of the displayed values to the nearest 0.1 gallon (liter)
1. Drive the vehicle at least 5 miles (8 km) with the speed control system engaged to display a stabilized average.
  2. Record the highway fuel economy for future reference.

It is important to press the RESET control after setting the speed control to get accurate highway fuel economy readings.

### **Trip elapsed drive time**

Select this function from the INFO menu to display your trip elapsed drive time. When selected the display will accumulate when the key is in the ON position.

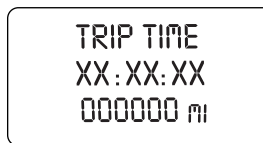

1. Press the INFO control until the message center display shows the TRIP TIME XX:XX:XX.
2. Hold the RESET control down for two seconds to clear display.

### **Display on/off**

Select this function from the INFO menu to turn the upper two lines of the message center display OFF or ON.

### **Setup menu**

Press this control for the following displays:

- Language
- Units (English/Metric)
- System Check

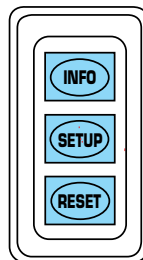



## Driver Controls

### **Language**

1. Select this function from the SETUP menu for the current language to be displayed.

ENGLISH  
RESET  
FOR NEW

2. Pressing the RESET control cycles the message center through each of the language choices.

FOR  
ENGLISH  
HOLD RESET

3. Press and hold the RESET control for 2 seconds to set the language choice.

SET  
TO  
ENGLISH

### **Units (English/Metric)**

1. Select this function from the SETUP menu for the current units to be displayed.

UNITS  
>ENGLISH  
METRIC

2. Press the RESET control to change from English to Metric.

### **System check**

Selecting this function from the SETUP menu causes the message center to cycle through each of the systems being monitored. For each of the monitored systems, the message center will indicate a warning message for three seconds when there is a malfunction.

RESET FOR  
SYSTEM  
CHECK

## Driver Controls

Pressing the RESET control cycles the message center through each of the systems being monitored and will display the following **only when there is a malfunction**.

1. Oil life in XX%
2. Charging system
3. Washer fluid level
4. Brake fluid level
5. Liftgate status
6. Exterior lamps status
7. Traction Control<sup>™</sup> status
8. Tire pressure monitoring system
9. Fuel level status (hold to reset to relearn)
10. Distance to empty

### **System warnings**

System warnings alert you to possible problems or malfunctions in your vehicle's operating systems.

In the event of a multiple warning situation, the message center will cycle the display to show all warnings by displaying each one for 4 seconds.

The message center will display the last selected feature if there are no more warning messages. This allows you to use the full functionality of the message center after you acknowledge the warning by pressing the RESET control and clearing the warning message.

Warning messages that have been reset are divided into three categories:

- They will reappear on the display ten minutes from the reset.
- They will not reappear until an ignition OFF-ON cycle has been completed.
- Warning returns upon another event.

This acts as a reminder that these warning conditions still exist within the vehicle.

## Driver Controls

Warning display	Status
Driver's door ajar	Warning cannot be reset
Passenger door ajar	
Left rear door ajar	
Right rear door ajar	
Park brake set	Warning returns after 10 minutes
Check brake system	
Liftgate ajar	Warning returns after the ignition key is turned from OFF to ON
Check left park lamp	
Check right park lamp	
Check left headlamp	
Check right headlamp	
Check left turn lamp	
Washer fluid low	
Check right turn lamp	
Low fuel level	
Change oil soon	
Low tire pressure	
Tire pressure monitor fault	
Tire pressure sensor fault	
Check brake lamps	

**DRIVER'S DOOR AJAR.** Displayed when the driver's door is not completely closed.

**PASSENGER DOOR AJAR.** Displayed when the passenger side door is not completely closed.

**LEFT REAR DOOR AJAR.** Displayed when the driver's rear door is not completely closed.

**RIGHT REAR DOOR AJAR.** Displayed when the passenger side rear door is not completely closed.

**LIFTGATE AJAR.** Displayed when the liftgate is not completely closed.

**PARK BRAKE SET.** Displayed when the manual park brake is set. If the warning stays on after the park brake is released, contact your authorized dealer as soon as possible.

**CHECK BRAKE SYSTEM.** Displayed when the braking system is not operating properly. If the warning stays on or continues to come on, contact your authorized dealer as soon as possible.

## Driver Controls

**CHECK BRAKE LAMPS.** Displayed when the brake lamps are activated and at least one is burned out. Check the lamps as soon as possible and have the burned out lamp replaced. The center high-mount brakelamp is not monitored.

**CHECK LEFT OR RIGHT HEADLAMPS.** Displayed when the headlamps are activated and at least one is burned out. Check the lamps as soon as possible and have the burned out lamp replaced. Refer to *Replacing headlamp bulbs* in the *Lights* chapter.

**CHECK LEFT OR RIGHT PARK LAMPS.** Displayed when the park lamps are activated and at least one is burned out. Check the lamps as soon as possible and have the burned out lamp replaced.

**CHECK LEFT OR RIGHT TURN LAMPS.** Displayed when the turn signals are activated and at least one is burned out. Check the lamps as soon as safely possible and have the burned out lamp replaced.

**LOW TIRE PRESSURE.** Displayed when one or more tires on your vehicle have low tire pressure. Refer to *Inflating Your Tires* in the *Tires, Wheels and Loading* chapter.

**TIRE PRESSURE MONITOR FAULT.** Displayed when the Tire Pressure Monitoring System is malfunctioning. If the warning stays on or continues to come on, have the system inspected by your authorized dealer.

**TIRE PRESSURE SENSOR FAULT.** Displayed when a tire pressure sensor is malfunctioning, or your spare tire is in use. For more information on how the system operates under these conditions, refer to *Understanding Your Tire Pressure Monitoring System* in the *Tires, Wheels and Loading* chapter. If the warning stays on or continues to come on, have the system inspected by your authorized dealer.

**TURN SIGNAL ON REMINDER.** Displayed when the turn signal is activated and the vehicle is driven more than 0.8 km (1/2 mile).

**LOW FUEL LEVEL.** Displayed when the fuel level in the fuel tank is at or near empty.

**WASHER FLUID LOW.** Indicates the washer fluid reservoir is less than one quarter full. Check the washer fluid level. Refer to *Windshield washer fluid* in the *Maintenance and Specifications* chapter.

**CHANGE OIL SOON.** Displayed when the engine oil life remaining is 5 percent or less. When oil life left is between 5% and 0%, the CHANGE OIL SOON message will be displayed. When oil life left reaches 0%, the OIL CHANGE REQUIRED message will be displayed.

An oil change is required whenever indicated by the message center.  
USE ONLY RECOMMENDED ENGINE OILS.

## Driver Controls

To reset the oil monitoring system to 100% after each oil change [approximately 5,000 miles (8,000 km) or 180 days] perform the following:

1. Press the SETUP control to access the System Check function.



RESET FOR  
SYSTEM  
CHECK

2. Press and release the RESET control to display "OIL LIFE XX% HOLD RESET NEW".

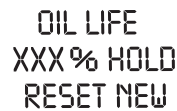

OIL LIFE  
XXX % HOLD  
RESET NEW

3. Press and hold the RESET control for 2 seconds to display "IF NEW OIL, HOLD RESET".



IF NEW  
OIL, HOLD  
RESET

4. Press and hold the RESET control to display "OIL LIFE SET TO 100%". Your oil life is now reset.

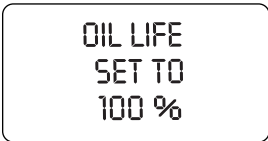

OIL LIFE  
SET TO  
100 %

To reset the oil monitoring system to your personalized oil life %:

1. Press the SETUP control to access the System Check function.

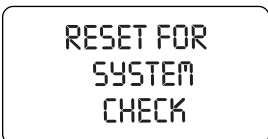

RESET FOR  
SYSTEM  
CHECK

## Driver Controls

2. Press and release the RESET control to display “OIL LIFE XX% HOLD RESET NEW”.

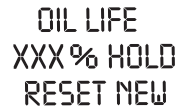

OIL LIFE  
XXX% HOLD  
RESET NEW

3. Press and hold the RESET control for 2 seconds to display “IF NEW OIL, HOLD RESET”.



IF NEW  
OIL, HOLD  
RESET

4. Release the RESET control momentarily, then press RESET and SETUP controls at the same time to activate a service mode which will display “OIL LIFE XX% RESET TO ALTER”.

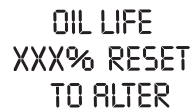

OIL LIFE  
XXX% RESET  
TO ALTER

5. Press RESET until you find your personalized OIL LIFE XX%.

6. With your personalized OIL LIFE XX% displayed, press SETUP to continue the system check.

**DATA ERR.** These messages indicate improper operation of the vehicle network communication between electronic modules.

- Fuel Computer
- Oil life
- Charging system
- Door sensor
- Liftgate sensor
- Exterior lamps
- Traction control
- Washer fluid
- Brake Fluid

Contact your authorized dealer as soon as possible if these messages occur on a regular basis.

## Driver Controls

### POSITIVE RETENTION FLOOR MAT (IF EQUIPPED)

 Do not install additional floor mats on top of the factory installed floor mats as they may interfere with the accelerator or the brake pedals.

#### To install floor mats that have a retention post:

Position the floor mat so that the eyelet is over the pointed end of the retention post and rotate forward to lock in. Make sure that the mat does not interfere with the operation of the accelerator or the brake pedal. To remove the floor mat, reverse the installation procedure.

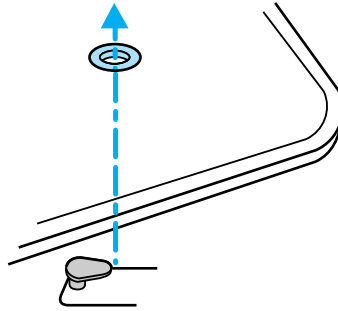



### LIFTGATE

Unlock the liftgate (but not release it) with the power door lock system and remote entry transmitter.

To open the liftgate, pull the liftgate handle rearward.

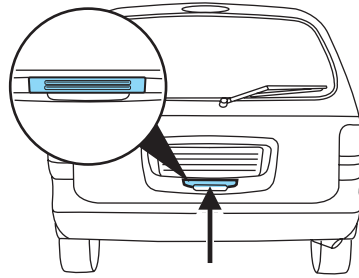
- Do not open the liftgate in a garage or other enclosed area with a low ceiling. If the liftgate is opened, the liftgate could be damaged against a low ceiling.
- Do not leave the liftgate open while driving. Doing so could cause serious damage to the liftgate and its components as well as allowing carbon monoxide to enter the vehicle.



 Make sure that the liftgate door is closed to prevent exhaust fumes from being drawn into the vehicle. This will also prevent passengers and cargo from falling out. If you must drive with the liftgate door open, keep the vents open so outside air comes into the vehicle.

## Driver Controls

### POWER LIFTGATE (PLG) (IF EQUIPPED)

With this option, you can power open or close the liftgate with the provided controls.

- overhead console button
- remote entry transmitter button
- outside release handle
- liftgate trim-mounted switch (closing)

#### Opening and Closing the PLG:

The PLG controls will operate without having the key in the ignition. The transaxle must be in PARK to power operate the PLG, when the key is in the ignition and turned to the ON position. When the liftgate is being power closed, a chime will sound three times before the liftgate begins to power close. A single chime indicates a problem with the close request. A faster chime indicates there is an excessive load on the liftgate (snow, bike rack, etc.) or a possible strut malfunction. If the excessive load is removed and you still have a faster chime, have the system serviced immediately by your authorized dealer.



**WARNING:** Make sure all persons are clear of the power liftgate area before using the power liftgate controls to open or close the liftgate.



Keep the keys out of the reach of children. Do not allow children to play on or near an open or moving power liftgate.

Exercise care, when power opening or closing the PLG in a garage or other enclosed area with a low ceiling or close to a wall/garage door. The PLG could be damaged from the contact.

Do not attempt to manually force the PLG to travel faster than the power system will permit.

When power operating the PLG at temperatures below 32° F (0° C), the PLG may stop about 5 inches (12.7 cm) from the full open position. The PLG can be fully opened by pushing it upward to the maximum open position.



## Driver Controls

The Power Door Lockout Control is located in the overhead console. With the control in the OFF position, power operation is disabled from the liftgate handle and from the liftgate trim switch. The overhead console switch and remote entry transmitter will operate the liftgate regardless of the position of the lockout switch.

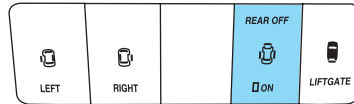

### To power open or close the PLG from the Overhead console:

1. Press and release the control to power open the PLG.
2. Press and release the control again to power the PLG closed.

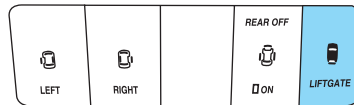

### To power open or close the PLG with the Remote entry transmitter:

1. Press this control twice within three seconds to power open the PLG. The interior lamps will illuminate.
2. Press this control another two times within three seconds to close the PLG and turn off the interior lights.

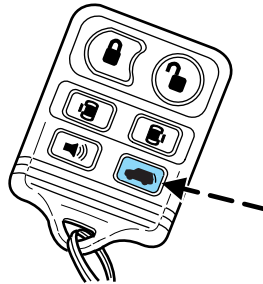

Refer to *Remote Entry System* in the *Locks and Security* chapter.

### To power open the PLG with outside release handle:

1. Ensure that the Power Door Lockout Control in the overhead console is ON.
2. Ensure that the PLG is unlocked, using the remote entry transmitter or power door unlock. Refer to *Remote Entry System* in the *Locks and security* chapter.
3. Pull up on the liftgate handle to engage the power assist feature. Release the handle as soon as the PLG begins to power open.

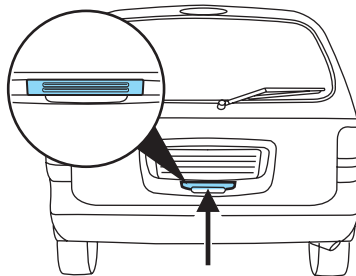

## Driver Controls

**Note:** Continued force applied after unlatching may activate the obstacle detection feature and stop the power system. For the best performance allow the power system to open the PLG after releasing the handle.

### To power close the PLG from the liftgate trim switch:

1. Ensure the Power Door Lockout Control is in the ON position.
2. Press and release the control on the bottom of the liftgate trim panel to engage the power assist feature. If a single chime is heard, check to be sure that the Power Door Lockout Switch is set to ON and that the transaxle is in Park.

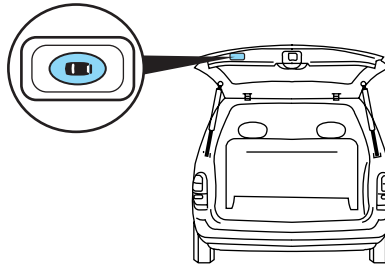

### To operate the PLG manually:

1. Disable the liftgate power function by placing the Power Door Lockout Control in the OFF position.
2. Open and close the liftgate as you would a standard liftgate.

**Note:** In case of operation in extreme cold  $-40^{\circ}\text{F}$  ( $-40^{\circ}\text{C}$ ), or on extreme inclines, manual operation of the liftgate is suggested.

### Safety/Obstructions

If anything obstructs the PLG while it is power opening or closing, the PLG will automatically reverse or stop depending on the position of the liftgate, provided it meets sufficient resistance. If the PLG encounters an obstacle while closing, the PLG will reverse to full open. Once the obstacle is removed, the PLG can be again closed under power. If the PLG encounters an obstacle while opening, the PLG will stop when it encounters a solid obstacle. Close the liftgate manually and remove the obstruction. Normal operation can then be resumed.

### Resetting the PLG:

The power liftgate may not operate properly if any of the following conditions occur:

- a low voltage or dead battery
- disconnected battery
- the liftgate has been left open or unlatched for more than six (6) hours

## Driver Controls

If any of these conditions occur, the PLG must be reset. To reset the PLG:

1. Manually close and fully latch the liftgate.
2. Power open the liftgate by using the remote entry transmitter or overhead console button.
3. Once the liftgate is fully open, close the liftgate using the power switch on the liftgate, remote entry transmitter or overhead console button.

### Liftgate ajar signal

If the liftgate is not fully latched, you will receive a “LIFTGATE AJAR” message on the instrument panel. If you see this message, check the liftgate to ensure it is fully latched.



Make sure the liftgate is closed to prevent exhaust fumes from being drawn into the vehicle. If you must drive with the liftgate open, keep the climate control vents open so that fresh outside air circulates through the vehicle.

## CARGO AREA FEATURES

### Cargo net (if equipped)

The cargo pouch net secures lightweight objects in the cargo area. Attach the net to the anchors provided. Do not put more than 50 lbs. (22 kg) in the net.



The cargo net is not designed to restrain objects during a collision or heavy braking.

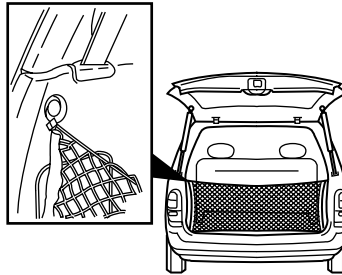

## Driver Controls

### Utility hooks

The utility hooks can be used to hang small items. Do not hang more than 20 lb. (12 kg) on each of the hooks. The hooks are not designed to restrain objects during a collision.

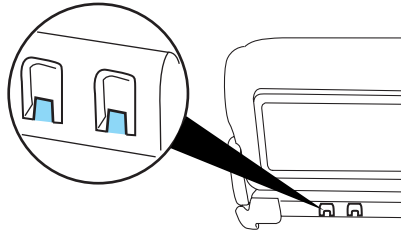

### LUGGAGE RACK (IF EQUIPPED)

Maximum load is 125 lbs (57 kg) on the roof rack structure, or 100 lbs (45 kg) on the roof panel, evenly distributed. If it is not possible to distribute the load, position it as far rearward as possible.

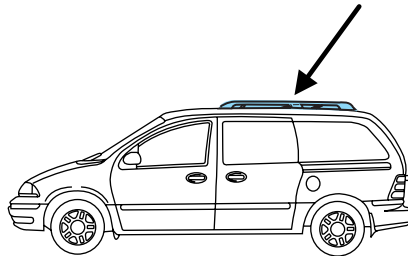

### To adjust the cross-bar (if equipped) position:

1. Loosen the thumbwheel at both ends of the cross-bar (both cross-bars are adjustable).
2. Slide the cross-bar to the desired location.
3. Tighten the thumbwheel at both ends of the cross-bar.

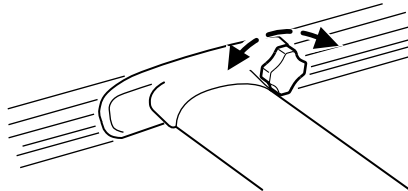

## Driver Controls

### To remove the cross-bar assembly (if equipped):

1. Remove rear support covers from the rear rails. Place a small object into the pin holes and slide the cover out towards the rear of the vehicle.

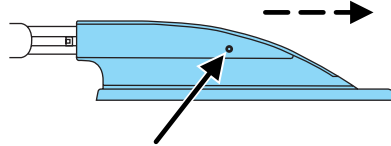

2. Loosen the thumbwheel at both ends of the cross-bar and slide the cross-bar towards the rear of the vehicle.

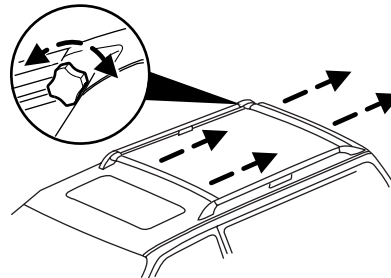

3. De-press the metal retention clip located in the inner rail channel on both sides, and slide the crossbar out simultaneously.

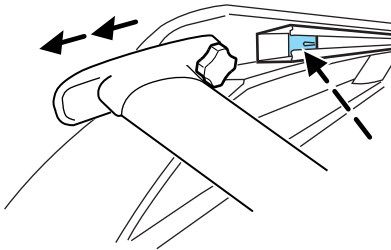

## Driver Controls

### To reinstall the cross-bar assembly (if equipped):

1. Slide the cross-bar into the rail track with the arrow facing towards the front of the vehicle. Slide the bar forward passed the retaining clip.

2. Firmly tighten the thumbscrews at both ends of the cross-bar.

3. Install both support covers by sliding the covers back into the channel and pushing gently into place.

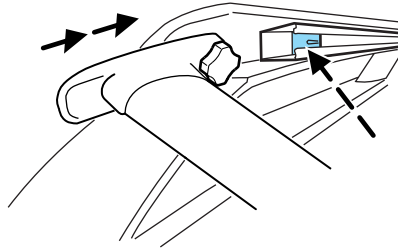

**Note:** When the cross-bars are not in use, remove or move the cross-bars to the back of the roof rack for optimum wind noise.

## Locks and Security

### KEYS

The key operates all locks on your vehicle. In case of loss, replacement keys are available from your dealer.

You should always carry a second key with you in a safe place in case you require it in an emergency.

Refer to the *SecuriLock™ passive anti-theft system* section in this chapter for more information.

### POWER DOOR LOCKS

Press the top portion of the control to unlock all doors and the bottom portion to lock all doors. **Note:**

When the perimeter alarm is armed, the power door locks “inhibit” state is enabled and this switch is disabled.

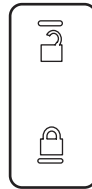

### Memory lock

If you lock your doors with the power lock switch, the keyless entry system or the remote entry transmitter while the sliding door is open, the door will automatically lock after it is closed.

### Smart locks (if equipped)

This feature prevents you from locking yourself out of the vehicle if your key is still in the ignition.

When you open the driver's door and you lock the vehicle with the power door lock control, all the doors will lock, then the driver's door will automatically unlock reminding you that your key is still in the ignition.

The vehicle can still be locked, with the key in the ignition, using the manual lock button on the door, locking the driver's door with a key, by simultaneously pressing button 7 • 8 and the 9 • 0 controls on the remote entry keypad (if equipped), or using the lock button on the remote entry transmitter (if equipped).

### Unlocking the liftgate during a battery failure

In the event of a vehicle power failure affecting the liftgate latch, the liftgate can be unlocked manually.

## Locks and Security

1. Locate the liftgate trim access panel in the center of the liftgate.

2. Using your key, a small screwdriver or knife, pry off the access panel.

3. Using your key, a small screwdriver or knife, poke or cut a hole in the liftgate door foam as large as the access window and move the lock/unlock lever accordingly:

- For vehicles without power liftgate, pull the lock/unlock lever to the right (drivers side).

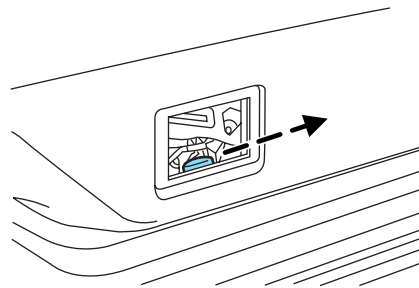
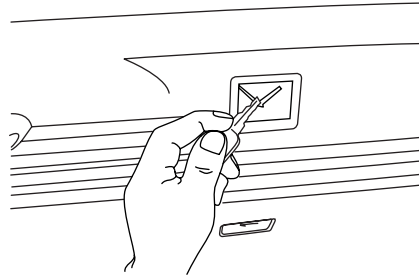

- For vehicles with power liftgate, pull the lock/unlock lever toward you (toward the front of the vehicle).

Once the lock/unlock lever has been moved, you can open the liftgate from the outside liftgate handle.

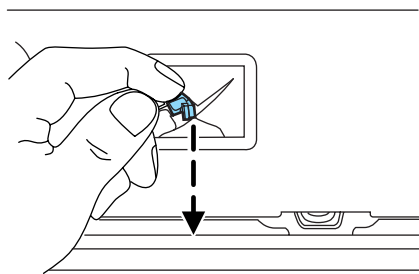

### Autolock

This feature automatically locks all vehicle doors when:

- all doors are closed,
- the ignition is in the 4 (ON) position,
- the brake is pressed before reaching 5 mph (8 km/h), and
- the vehicle increases to more than 5 mph (8 km/h).



## Locks and Security

### **Relock**

The autolock feature repeats when:

- an “autolock” occurrence has already taken place,
- the brake is depressed while vehicle speed is less than 5 mph (8 km/h),
- all vehicle doors become closed again, and
- the vehicle increases to more than 5 mph (8 km/h).

### **Deactivating/activating the autolock feature**

The autolock feature can be enabled or disabled by the keyless entry keypad (if equipped) on your door, driver configuration mode or by your authorized dealer.

### **Deactivating/reactivating the autolock feature using the keypad (if equipped)**

Your vehicle comes with the autolock feature activated. To deactivate/reactivate this feature:

1. Turn the ignition to the 3 (OFF) position.
2. Close all the doors.
3. Enter the 5-digit entry code.
4. Press and hold the 7 • 8. While holding the 7 • 8, press the 3 • 4.
5. Release the 3 • 4.
6. Release the 7 • 8.

The horn will chirp once when the system has been successfully deactivated.

The horn will chirp twice (one short and one long chirp) when the system has been successfully reactivated.

### **To deactivate/reactivate the autolock feature using the power door unlock control**

You must close all the vehicle doors and complete Steps 1-7 within 30 seconds or the procedure will have to be repeated. If the procedure needs to be repeated, you must wait 30 seconds.

1. Turn the ignition key to the 4 (ON) position.
2. Press the power door unlock control three times.
3. Turn the ignition key from the 4 (ON) position to the 3 (OFF) position.

## Locks and Security

4. Press the power door unlock control three times.
5. Turn the ignition back to the 4 (ON) position. The horn will chirp.
6. Press the unlock control, then press the lock control. The horn will chirp once if autolock was deactivated or twice (one short and one long chirp) if autolock was activated.
7. Turn the ignition to the 3 (OFF) position. The horn will chirp once to confirm the procedure is complete.

### CHILDPROOF DOOR LOCKS

- When these locks are set, the sliding doors cannot be opened with the inside handle.
- The sliding doors can be opened from the outside when the doors are unlocked.

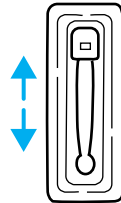

The childproof lock controls are located on front edge of each sliding door and must be set separately for each door. Setting the lock for one door will not automatically set the lock for both doors.

- Move lock control up to engage the childproof lock feature.
- Move control down to disengage childproof lock feature.

If your vehicle is equipped with power sliding door(s), refer to the *Power sliding door* section of this chapter for more information on how the childproof locks operate with this system.

### REMOTE ENTRY SYSTEM

This device complies with part 15 of the FCC rules and with RS-210 of Industry Canada. Operation is subject to the following two conditions: (1) This device may not cause harmful interference, and (2) This device must accept any interference received, including interference that may cause undesired operation.

**Changes or modifications not expressly approved by the party responsible for compliance could void the user's authority to operate the equipment.**

The typical operating range for your remote entry transmitter is approximately 33 feet (10 meters). A decrease in operating range could be caused by:

- weather conditions,

## Locks and Security

- nearby radio towers,
- structures around the vehicle, or
- other vehicles parked next to your vehicle.
- 3-button remote

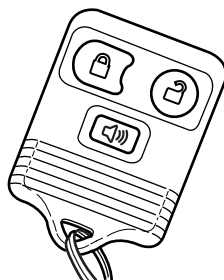

- 5-button remote

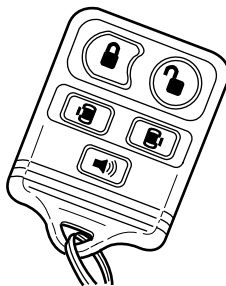

- 6-button remote

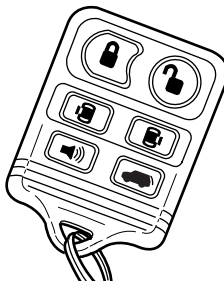

The remote entry system allows you to:



- lock or unlock all vehicle doors and liftgate without a key.
- unlock/open a driver's side power sliding door and/or passenger side power sliding door (if equipped).
- unlock/open the power liftgate (PLG) (if equipped).

## Locks and Security

- activate the personal alarm.
- arm and disarm the perimeter anti-theft system (if equipped).

If there are problems with the remote entry system, make sure to take **ALL remote entry transmitters** with you to the authorized dealer in order to aid in troubleshooting the problem.

### Unlocking the doors

1. Press  and release to unlock the driver's door. **Note:** The interior lamps will illuminate and the anti-theft system (if equipped) will disarm.
2. Press  and release again within three seconds to unlock all doors and the liftgate.

### Opening/closing power sliding doors (if equipped)

- 5-button remote

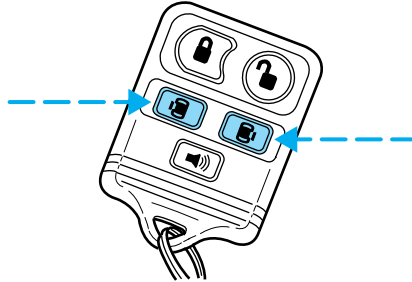

- 6-button remote

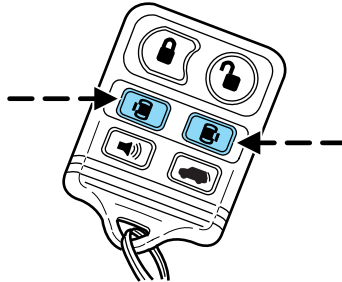

- Press this control twice within three seconds to open the power sliding door. The interior lamps will illuminate.
- Press this control another two times within three seconds to close the power sliding door and turn off the interior lights.

## Locks and Security

### Opening power liftgate (PLG) (if equipped)

Press the control twice within three seconds to power open the power liftgate. The interior lamps will illuminate.

 Make sure all persons are clear of the power liftgate area before using the power liftgate controls to open or close the liftgate.

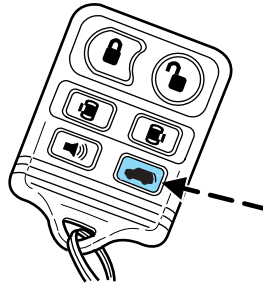



Press the control another two times within three seconds to close the power liftgate and turn off the interior lights.

If anything obstructs the power liftgate while it is power opening or closing, the power liftgate will automatically reverse or stop depending on the position of the liftgate, provided it meets sufficient resistance. If the power liftgate encounters an obstacle while closing, the power liftgate will reverse to full open. Once the obstacle is removed, the power liftgate can be again closed under power. If the power liftgate encounters an obstacle while opening, the power liftgate will stop when it encounters a solid obstacle. Close the liftgate manually and remove the obstruction. Normal operation can then be resumed.

 Make sure the power liftgate is closed to prevent exhaust fumes from being drawn into the vehicle. If you must drive with the liftgate open, keep the climate control vents open so that fresh outside air circulates through the vehicle.

For more information regarding the operation of the power liftgate, refer to *Power liftgate (PLG) (if equipped)* in the *Driver Controls* chapter.

### Locking the doors

1. Press  and release to lock all the doors and liftgate. The parking lamps will flash once if all doors, the liftgate and the hood (if equipped with perimeter alarm) are closed and locked.
2. Press  and release again within three seconds to confirm that all the doors and liftgate are closed and locked. **Note:** The doors will lock again, the horn will chirp once, and the parking lamps will flash once more.

## Locks and Security

If any of the doors, the liftgate or the hood (if equipped with perimeter alarm) are not properly closed, the horn will make two quick chirps and the parklamps will not flash.

### Sounding a panic alarm

Press  to activate the alarm. The alarm will cycle the horn, the turn signals will flash, and the interior lamps will illuminate.

Press again or turn the ignition to the 4 (ON) or the 1 (ACCESSORY) position to deactivate.

### Memory feature (if equipped)

The remote entry system allows you to recall the memory seat/side view mirrors/adjustable pedals feature.

Press  to automatically move the driver seat, side view mirrors and adjustable pedals to the desired memory position.

### Associating the remote transmitter with the memory feature

To activate this feature:

1. Position the driver's seat, side view mirrors and adjustable pedals to the positions you desire.
2. Press the SET control on the door next to the window inside from the mirror.
3. Within 5 five seconds, press any control on the remote transmitter and then press the 1 or 2 control on the driver's door panel to associate with the Driver 1 or Driver 2 positions.
4. Repeat this procedure for another remote transmitter if desired.

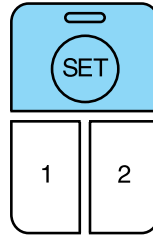

### Disassociating the memory feature from the remote transmitter

To deactivate this feature:

1. Press the SET control on the driver's door panel.
2. Within 5 five seconds, press any control on the remote transmitter which you would like to deactivate and then press the SET control on the driver's door panel again.
3. Repeat this procedure for another remote transmitter if desired.

## Locks and Security

### Replacing the battery

The remote entry transmitter uses one coin type three-volt lithium battery CR2032 or equivalent.

To replace the battery:

1. Twist a thin coin between the two halves of the remote entry transmitter near the key ring. **DO NOT TAKE THE RUBBER COVER AND CIRCUIT BOARD OFF THE FRONT HOUSING OF THE REMOTE ENTRY TRANSMITTER.**

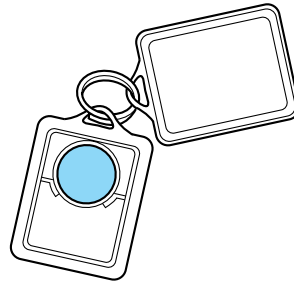

2. Do not wipe off any grease on the battery terminals on the back surface of the circuit board.

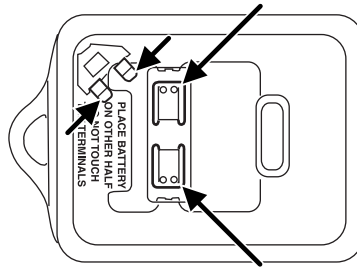

3. Remove the old battery. **Note:** Please refer to local regulations when disposing of transmitter batteries.

4. Insert the new battery. Refer to the diagram inside the remote entry transmitter for the correct orientation of the battery. Press the battery down to ensure that the battery is fully seated in the battery housing cavity.

5. Snap the two halves back together.

**Note:** Replacement of the battery will **not** cause the remote transmitter to become deprogrammed from your vehicle. The remote transmitter should operate normally after battery replacement.

### Replacing lost remote entry transmitters

If you would like to have your remote entry transmitter reprogrammed because you lost one, or would like to buy additional remote entry

## Locks and Security

transmitters, you can either reprogram them yourself, or take **all remote entry transmitters** to your authorized dealer for reprogramming.

### **How to reprogram your remote entry transmitters**

You must have **all remote entry transmitters** (maximum of six) available before beginning this procedure.

**Note:** Ensure the brake pedal is not depressed during this sequence.

To reprogram the remote entry transmitters:

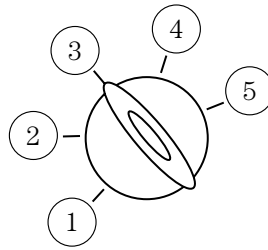

1. Ensure the vehicle is electronically unlocked.
2. Put the key in the ignition.
3. Turn the key from the 3 (OFF) position to 4 (ON).
4. Cycle eight times rapidly (within 10 seconds) between the 3 (OFF) position and 4 (ON). **Note:** The eighth turn must end in the 4 (ON) position.
5. The doors will lock, then unlock, to confirm that the programming mode has been activated.
6. Within 20 seconds press any button on the remote entry transmitter. **Note:** If more than 20 seconds have passed you will need to start the procedure over again.
7. The doors will lock, then unlock, to confirm that this remote entry transmitter has been programmed.
8. Repeat Step 6 to program each additional remote entry transmitter.
9. Turn the ignition to the 3 (OFF) position after you have finished programming all of the remote entry transmitters.
10. The doors will lock, then unlock, to confirm that the programming mode has been exited.

### **Illuminated entry**

The interior lamps illuminate when the key in the driver's door lock cylinder (if equipped with perimeter alarm), the keyless entry system or



## Locks and Security

the remote entry transmitter is used to unlock the door(s), power sliding doors (if equipped) or liftgate.

The illuminated entry system will turn off the interior lights if:

- the ignition switch is turned to the 4 (ON) position, or
- the keyless entry system or the remote entry transmitter lock control is pressed, or
- after 25 seconds of illumination.

The panel dimmer control must **not** be set to the off position for the illuminated entry system to operate.

The inside lights will not turn off if:

- they have been turned on with the panel dimmer control, or
- any door, power sliding door (if equipped) or the liftgate is open.

The battery saver will shut off the interior lamps 30 minutes after the last door is closed, even if the panel dimmer control is left on.

### ***Illuminated exit***

- The interior lights will illuminate when the key is removed from the ignition.
- When the headlamp control is on the “sleeping baby mode”, only the lower interior lights will illuminate.

The system automatically turns off after 25 seconds. The panel dimmer control must **not** be set to the off position for the illuminated exit to operate.

### **Perimeter lamps illuminated entry (if equipped)**

The exterior lamps illuminate when the vehicle is unlocked using the remote entry transmitter, keyless keypad, or the driver’s door key lock cylinder (if equipped with perimeter alarm). The following items will illuminate:

- Puddle lamps
- Head lamps
- Park lamps
- Tail lamps

The system will automatically turn off if:

- the vehicle is locked using the remote entry system, the keyless entry keypad, or

## Locks and Security

- the ignition is turned to the 4 (ON) position, or
- after 25 seconds of illumination.

### **Deactivating/activating perimeter lamps**

You may enable/disable this feature by having your vehicle serviced by your authorized dealer.

You may also perform the following power door lock sequence to enable/disable the perimeter lamps feature:

1. Turn the ignition to the 4 (ON) position, then press the power door unlock control 3 times.
2. Turn the ignition to the 3 (OFF) position, then press the power door unlock control 3 times.
3. Turn the ignition to 4 (ON) position. Completing the sequence within 30 seconds enters a program mode and is confirmed by a horn chirp. Activating or deactivating perimeter lighting once in program mode is accomplished by:

- Pressing the power door unlock control twice within five seconds. At this point, perimeter lighting will be activated if it was previously deactivated, and deactivated if it was previously activated. Confirmation of perimeter lighting being activated is provided by a short horn chirp followed by a long horn sound; Confirmation of perimeter lighting being deactivated is provided by a short horn chirp only.
- Exiting the program mode is accomplished by turning the ignition to any position other than the 4 (ON) position, or two minutes elapsing since the program mode was entered.

**Note:** The puddle lamps cannot be deactivated. Performing this deactivation procedure will only deactivate the head, park and tail lamps. For information regarding perimeter lamps delay, refer to *Autolamps - Programmable exit delay* in the *Lights* chapter.

### **KEYLESS ENTRY SYSTEM (IF EQUIPPED)**

You can use the keyless entry keypad to:

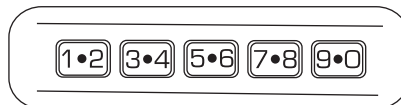

- lock or unlock the doors without using a key.
- activate or deactivate the autolock feature.

## Locks and Security

- open and close the right and left power sliding doors (if equipped).
- recall memory seat/side view mirrors/adjustable pedals position Driver 1 or Driver 2 (if equipped).

The keypad can be operated with the factory set 5–digit entry code; this code is located:

- on the owner's wallet card in the glove box,
- marked on the passenger compartment fuse panel (located below and to the left of the steering, near the brake pedal),
- and is available from your authorized dealer.

You can also create your own 5–digit personal entry code.

When pressing the controls on the keypad, press the middle of the controls to ensure a good activation.

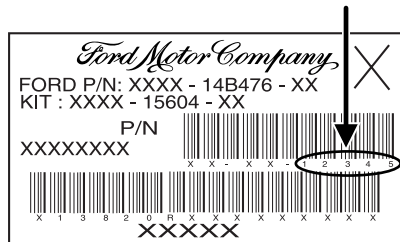

### Programming a personal entry code

To create your own personal entry code(s):

1. Enter the factory set code. **Note:** The driver's door will unlock.
2. Within five seconds press and release the 1 • 2 on the keypad. **Note:** The lock motors will cycle, locked then unlocked.
3. Enter your personal 5-digit code. Each number must be entered within five seconds of each other.
4. Enter a sixth digit if you wish to have the personal entry code recall memory position Driver 1 or Driver 2 (if equipped with the memory seat/side view mirrors/adjustable pedals feature). **Note:** The lock motors will cycle, locked then unlocked.
  - Press 1 • 2 to recall the Driver 1 position.
  - Press 3 • 4 to recall the Driver 2 position.
5. After five seconds of keypad inactivity, programming mode is exited.

All of the vehicle doors will lock and unlock to confirm the code has been stored. Each memory feature driver position (Driver 1 or Driver 2) can be associated with only one personal code. The factory-set code cannot be associated with a memory recall position.

You can program up to three personal codes; these codes do not replace the factory-set code.

## Locks and Security

### Tips for setting codes:

- The factory set code cannot be erased or changed.
- The factory code will work even after you have set your own personal codes.
- Do not set a code that uses five of the same number.
- Do not use five numbers in sequential order.

### Erasing personal code

1. Enter the factory set 5–digit code.
2. Within five seconds of entering the factory code, press and release the 1 • 2 control. The door locks will lock and quickly unlock to confirm entry into the programming mode.
3. Within five seconds of Step 2, press and hold the 1 • 2 for two seconds to erase the customer programmed code.

The programming mode is exited after five seconds of keypad inactivity. The door locks will lock and quickly unlock to confirm programming mode has been exited.

The personal code is now erased and only the factory set 5–digit code will work.

### Unlocking and locking the doors using keyless entry

**To unlock the driver's door,** enter the factory set 5-digit code or your personal code. Each number must be pressed within five seconds of each other. The keyless entry keypad will illuminate after pressing the first control on the keypad.

**To unlock all doors,** press the 3 • 4 control within five seconds.

**To lock all doors,** press the 7 • 8 and the 9 • 0 at the same time. You **do not** need to enter the keypad code first. **Note:** The interior lamps will turn off.

**To open (or close) the power sliding doors (if equipped),** press the 5 • 6 control within five seconds to open (or close) the left power sliding door or the 9 • 0 control in order to open (or close) the right power sliding door.

## Locks and Security

### SECURILOCK™ PASSIVE ANTI-THEFT SYSTEM

SecuriLock™ passive anti-theft system is an engine immobilization system. This system is designed to help prevent the engine from being started unless a **coded key programmed to your vehicle** is used. The SecuriLock™ passive anti-theft system is not compatible with non-Ford aftermarket remote start systems. Use of these systems may result in vehicle starting problems and a loss of security protection.

#### Anti-theft indicator

The anti-theft indicator is located on top of the instrument panel.

- When the ignition is in the 3 (OFF) position, the indicator will flash once every 2 seconds to indicate the SecuriLock™ system is functioning as a theft deterrent.
- When the ignition is in the 4 (ON) position, the indicator will glow for 3 seconds to indicate normal system functionality.

If a problem occurs with the SecuriLock™ system, the indicator will flash rapidly or glow steadily when the ignition is in the 4 (ON) position. If this occurs, the vehicle should be taken to an authorized dealer for service.

#### Key information

Your vehicle is supplied with **two coded keys**. Only a **coded key** will start your vehicle. Spare coded keys may be purchased from an authorized dealer. An authorized dealer can also program your **coded key**, or you can do it yourself. Refer to *Programming spare keys* in this chapter.

The following items may prevent the vehicle from starting:

- Large metallic objects.
- Electronic devices on the key chain that can be used to purchase gasoline or similar items.
- A second key on the same key ring as the **coded key**.

If any of these items are present, you need to prevent these objects from touching the **coded key** while starting the engine. These objects cannot damage the **coded key**, but may cause a momentary “no start” condition if they are too close to the key when starting the engine. If a problem occurs, turn the ignition to the 2 (OFF) position and restart the engine with all other objects on the key ring held away from the ignition key. Check to make sure the **coded key** is an approved **coded key**.

## Locks and Security

If your keys are lost or stolen, you will need to do the following:

- Use your spare key to start the vehicle, or
- Have your vehicle towed to an authorized dealer or a locksmith. The key codes will need to be erased from your vehicle and new codes will need to be re-coded.

Replacing coded keys can be very costly and you may want to store an extra programmed key away from the vehicle in a safe place to prevent an unforeseen inconvenience.

The correct **coded key** must be used for your vehicle. The use of the wrong **coded key** may lead to a “no start” condition.

**If an unprogrammed key is used in the ignition, it will cause a “no start” condition.**

### Programming spare keys

A maximum of eight keys can be coded to your vehicle. Only SecuriLock<sup>™</sup> keys can be used. To program a **coded key** yourself, you will need two previously programmed **coded keys** (keys that already operate your vehicle’s engine) and the new unprogrammed key(s) readily accessible for timely implementation of each step in the procedure.

If two previously programmed coded keys are not available, you must bring your vehicle to your authorized dealer to have the spare coded key(s) programmed.

Please read and understand the entire procedure before you begin.

1. Insert the first previously programmed **coded key** into the ignition and turn the ignition from the 3 (OFF) position to the 4 (ON) position [maintain ignition in 4 (ON) position for at least three seconds, but no more than ten seconds].

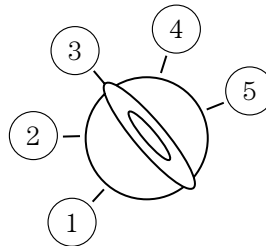

2. Turn ignition from the 4 (ON) position back to the 3 (OFF) position in order to remove the first **coded key** from the ignition.

3. Within ten seconds of removing the first **coded key**, insert the second previously programmed **coded key** into the ignition and turn the ignition from the 3 (OFF) position to the 4 (ON) position [maintain ignition in the 4 (ON) position for at least three seconds but no more than ten seconds].

## Locks and Security

4. Turn the ignition from the 4 (ON) position back to the 3 (OFF) position in order to remove the second **coded key** from the ignition.
5. Within 10 seconds of removing the second **coded key**, insert the new unprogrammed key (new key/valet key) into the ignition and turn the ignition from the 3 (OFF) position to the 4 (ON) position [maintain ignition in the 4 (ON) position for at least three seconds, but no more than ten seconds]. This step will program your new key to a coded key.
6. To program additional new unprogrammed key(s), repeat this procedure from step 1.

If successful, the new coded key(s) will start the vehicle's engine and the theft indicator will illuminate for three seconds and then go out.

If not successful, the new coded key(s) will not start the vehicle's engine and the theft indicator will flash on and off and you may repeat Steps 1 through 5. If failure repeats, bring your vehicle to your authorized dealer to have the new spare key(s) programmed.

### PERIMETER ALARM SYSTEM (IF EQUIPPED)

The perimeter anti-theft system will warn you in the event of an unauthorized entry to your vehicle.

If there is any potential perimeter anti-theft problem with your vehicle, ensure **ALL remote entry transmitters** are taken to the authorized dealer to aid in troubleshooting.

### Arming the system

When armed, this system will help protect your vehicle from unauthorized entry. When unauthorized entry occurs, the system will flash the turn signal lamps and side repeaters and honk the horn.

The system is ready to arm whenever the key is removed from the ignition. Any of the following actions will prearm the alarm system:

- Locking the vehicle using the remote entry transmitter.
- Locking the vehicle using the keyless entry keypad.
- Pressing the interior power door lock control while the door is open.

Twenty seconds after one of the above events occurs, any door/hood that is closed is armed.

Any door/hood that is still open is prearmed and waiting for the door/hood to be closed.

Once that input is closed, the input will arm in 20 seconds and the exterior lamps may flash.

## Locks and Security

### Disarming the system

You can disarm the system by any of the following actions:

- Unlock the vehicle with the remote keyless transmitter.
- Unlock the vehicle with the keyless entry keypad.
- Unlock the vehicle with a key in the driver's door lock cylinder.
- Use a SecuriLock<sup>™</sup> key to move the ignition to the 4 (ON) or 5 (START) position.



## Seating and Safety Restraints

### SEATING

#### Notes:



Reclining the seatback can cause an occupant to slide under the seat's safety belt, resulting in severe personal injuries in the event of a collision.



Do not pile cargo higher than the seatbacks to reduce the risk of injury in a collision or sudden stop.



Before returning the seatback to its original position, make sure that cargo or any objects are not trapped behind the seatback. After returning the seatback to its original position, pull on the seatback to ensure that it has fully latched. An unlatched seat may become dangerous in the event of a sudden stop or collision.

#### Adjustable head restraints (if equipped)

Head restraints help to limit head motion in the event of a rear collision. Adjust your head restraint so that it is located directly or as close as possible behind your head.

The head restraints can be moved up and down.

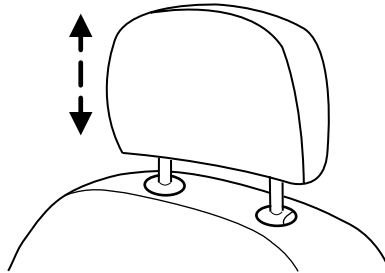

## Seating and Safety Restraints

Push control to lower head restraint.

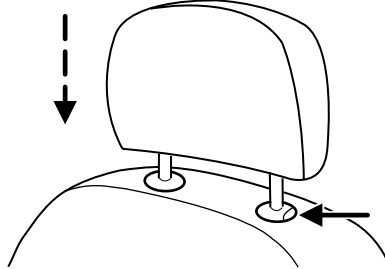

### Adjusting the front manual seat (if equipped)



Never adjust the driver's seat or seatback when the vehicle is moving.



Always drive and ride with your seatback upright and the lap belt snug and low across the hips.

Lift handle to move seat forward or backward.

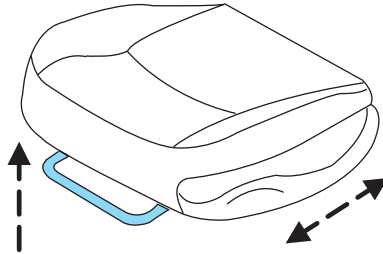

Pull lever up to adjust seatback.

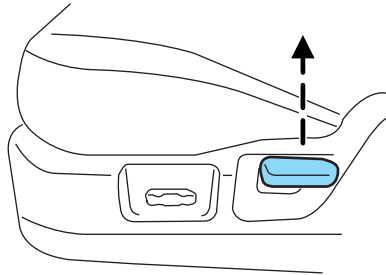

## Seating and Safety Restraints

 Before returning the seatback to its original position, make sure that cargo or any objects are not trapped behind the seatback. After returning the seatback to its original position, pull on the seatback to ensure that it has fully latched. An unlatched seat may become dangerous in the event of a sudden stop or collision.

### Using the manual lumbar support (if equipped)

The lumbar control is located on the inboard side of the seat under the armrest.

Rotate the control to change the firmness of the lumbar support.

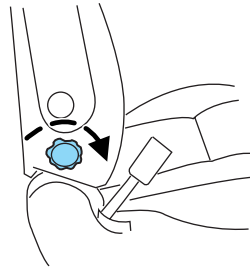



### Adjusting the front power seat (if equipped)

 Never adjust the driver's seat or seatback when the vehicle is moving.

 Do not pile cargo higher than the seatbacks to avoid injuring people in a collision or sudden stop.

 Always drive and ride with your seatback upright and the lap belt snug and low across the hips.

 Reclining the seatback can reduce the effectiveness of the seat's safety belt in the event of a collision.

 Sitting improperly out of position or with the seat back reclined too far can take off weight from the seat cushion and affect the decision of the passenger sensing system, resulting in serious injury or death in a crash. Always sit upright against your seatback, with your feet on the floor.

## Seating and Safety Restraints

 To reduce the risk of possible serious injury: Do not hang objects off seat back or stow objects in map pocket (if equipped) when a child is in the front passenger seat. Do not place objects underneath the front passenger seat or between the seat and the center console (if equipped). Check Passenger Airbag Disable Indicator for proper Airbag Status. Refer to Front Passenger Sensing System chapter for additional details. Failure to follow these instructions may interfere with the front passenger seat sensing system.

The control is located on the outboard side of the seat cushion.

Press to raise or lower the front portion of the seat cushion.

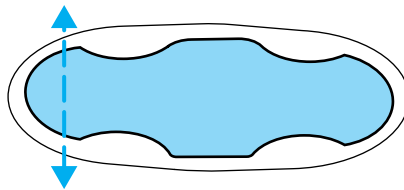

Press to raise or lower the rear portion of the seat cushion.

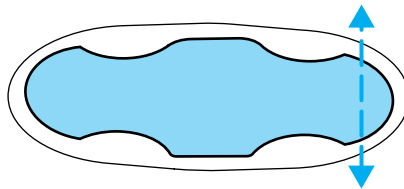

Press the control to move the seat forward, backward, up or down.

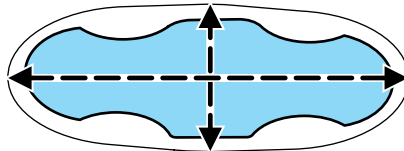

### Heated seats (if equipped)

To operate the heated seats:

- Push the control located on the climate control system panel once to activate high heat.



## Seating and Safety Restraints

- Push twice to activate low heat.
- Push a third time to deactivate.

The indicator light on the control will illuminate when activated. For low heat, one light will be lit; for high heat, both lights will be lit.

The heating of the seat turns off after 10 minutes or when the vehicle is turned off.

### Memory seats/sideview mirrors/adjustable pedals (if equipped)

This system allows automatic positioning of the driver seat, outside rearview mirrors, and adjustable pedals to two programmable positions.

The memory seat control is located on the door next to the window inside from the mirror.

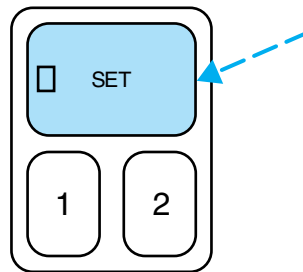

- To program position one, move the driver seat to the desired position using the seat controls. Press the SET control. The SET control indicator light will briefly illuminate. While the light is illuminated, press control 1.
- To program position two, repeat the previous procedure using control 2.

A position can only be recalled when the transmission gearshift is in Park. A memory seat position may be programmed at any time.

The memory positions are also recalled when you press your remote entry transmitter UNLOCK control if the transmitter is programmed to a memory position or when you enter a valid personal entry code that is programmed to a memory position.

To program the memory feature to a remote entry transmitter and for more information on how to use the keypad, refer to *Remote entry system* in the *Locks and Security* chapter.

## REAR SEATS

### Head restraints

Lift the head restraint so that it is located directly or as close as possible behind your head.

## Seating and Safety Restraints

The head restraints can be moved up and down by pulling up on the head restraint.

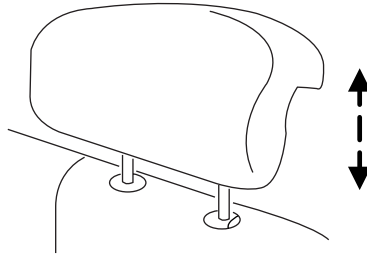

Push button to lower head restraint.

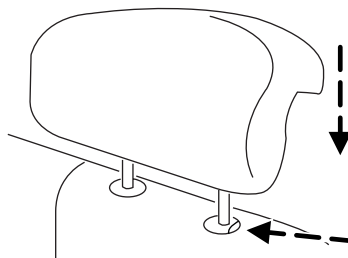

### Seat mounted cup holders (if equipped)

Deploy by pressing the button on top of the cupholder.

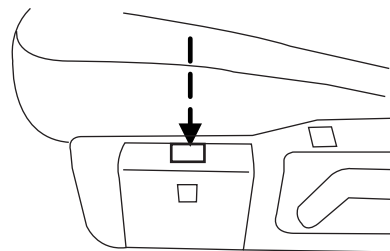

## Seating and Safety Restraints

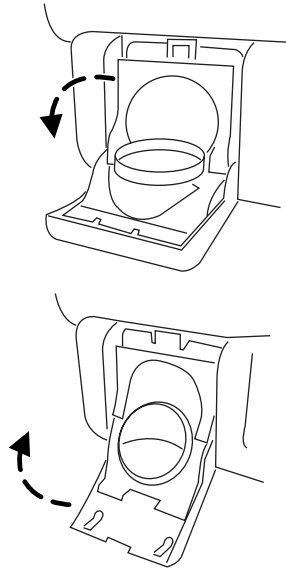

The cupholder is designed to detach from the seat when subjected to heavy load. The cupholder can be reinstalled by returning to the closed position.



Use only soft cups in the cupholder. Hard objects can injure you in a collision.

### Adjusting 2nd row seats (if equipped)

Lift control to adjust seat forward or backward.

- 2nd row bucket seat (if equipped)

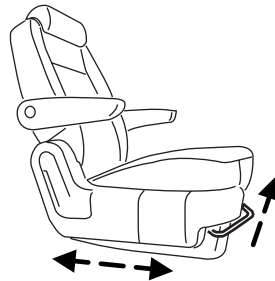

## Seating and Safety Restraints

- 2nd row bench seat (if equipped)

**Note:** This seat can be moved forward to keep a child in a LATCH child restraint attached to the LATCH anchors at the center of the bench seat close to the front seat occupants or to increase cargo room without removing the seat. The seat should be moved to the full rearward position when it is occupied by older children or adults, and when child seats are installed at the seating positions.

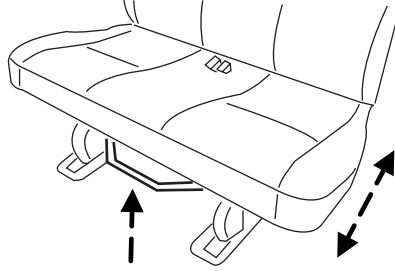

### **Adjusting second row bucket and bench seat back**

Pull control forward to adjust seat back. Using same control will fold the seat back flat.

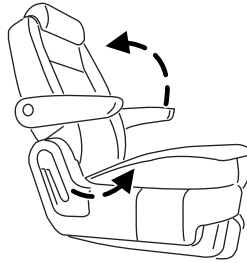

Reclining the seatback can cause an occupant to slide under the seat's safety belt, resulting in severe personal injuries in the event of a collision.



## Seating and Safety Restraints

### **Accessing the third row seat with a second row bucket seat**

Ensure head restraint is in the full down position and seat is adjusted to full rear position (if equipped).

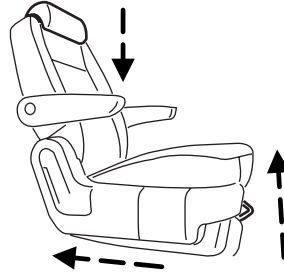

**Note:** Place the front row seat in a forward position to allow the 2nd row to be fully upright.

Lift the handle located on the rear lower corner of the seat.

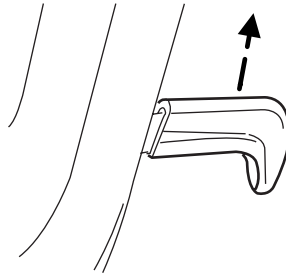

The seat back will fold flat.

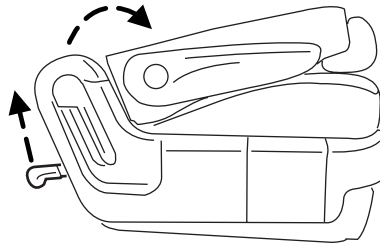

## Seating and Safety Restraints

Continuing to lift the handle will tumble the seat forward, allowing easier access to the third row seat.

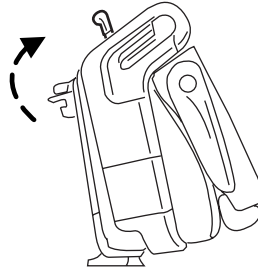

After entering the 3rd row seat, return the seat from the tumbled position and latch it to the floor.

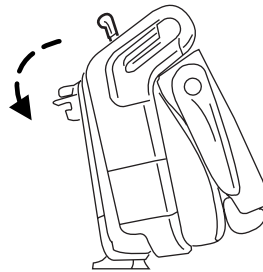

Operate recline control to return the seatback to the upright position.

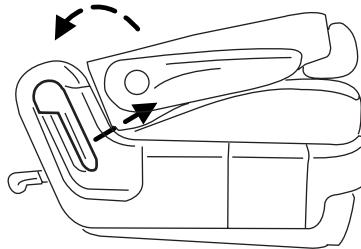

## Seating and Safety Restraints



- Ensure that the seat and seatback is latched securely in position.
- Keep floor area free of objects that would prevent proper seat engagement.
- Do not adjust or release the seat floor latch while vehicle is in motion.
- Do not operate the vehicle with seats in tumbled position. Failure to do any of these could result in personal injury.



Always latch the vehicle seat to the floor, whether the seat is occupied or empty. If not latched, the seat may cause injury during a sudden stop.



Before returning the seatback to its original position, make sure that cargo or any objects are not trapped underneath the seatback. After returning the seatback to its original position, pull on the seatback to ensure that it has fully latched. An unlatched seat may become dangerous in the event of a sudden stop or collision.



Always latch the vehicle seat to the floor, whether the seat is occupied or empty. If not latched, the seat may cause injury during a sudden stop.

### **Second row bench seat tip slide feature**

1. Push the side easy-entry control handle forward and allow the seat back to flip forward.
2. Push the seat forward to allow access to the third row.

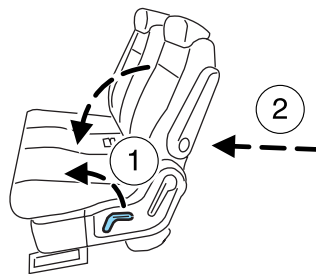

## Seating and Safety Restraints

After entering the 3rd row, pull back the seatback until it latches. This will latch and lock the seatback and the seat track. The seatback and seat will not return to their original position.

**Note:** Ensure the front row seat is in a forward position to allow the seat to return.

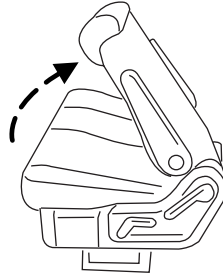

### **Exiting the third row seat**

#### **Second row bucket seats (if equipped)**

Follow directions for accessing the third row seat

#### **Second row bench seat**

To exit the third row, activate the easy entry system by pulling on the strap on the rear of the seat. This will cause the seatback to flip forward and the seat track latches to open.

Push the seat forward to allow easier exit from the third row.

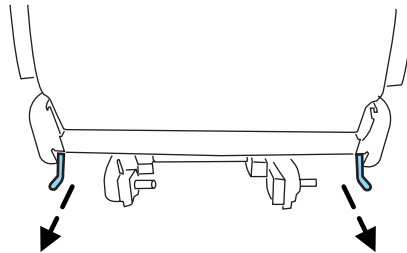

After exiting the third row, push rearward on the cushion of the seat to return the seat to its original position.

Push the seatback rearward until it latches. This will latch and lock the seatback and the seat track.

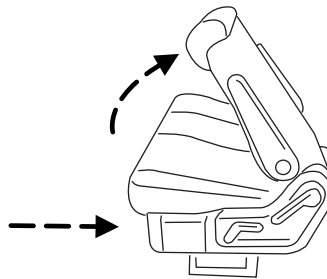

## Seating and Safety Restraints



Before returning the seatback to its original position, make sure that cargo or any objects are not trapped underneath the seatback. After returning the seatback to its original position, pull on the seatback to ensure that it has fully latched. An unlatched seat may become dangerous in the event of a sudden stop or collision.

**Note:** Do not attempt to return the seat by pushing on the seatback, as this will cause the seat tracks to re-lock before the seat can be returned. Push on the cushion to return the seat.

### Removal of second row seats from vehicle

1. Place the front row seat in a forward position to allow the 2nd row seat to be fully upright.
2. Place the 2nd row seat in a rear position to allow the 2nd row seat to be fully upright.
3. Place seat in tumbled position.  
(See *Accessing 3rd row seat*)

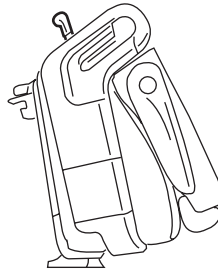

4. From inside the vehicle, pull up on front floor release handle.

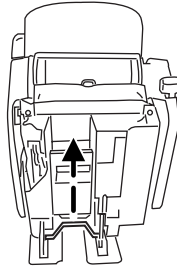

## Seating and Safety Restraints

5. Rotate the seat rearward at a 30 to 45 degree angle.

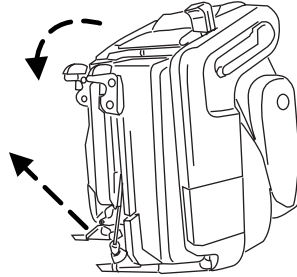

6. With the assist handle, pull the seat rearward.

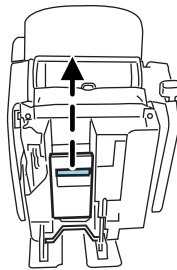

7. Remove the seat from vehicle.

### **Second row bench seat**

1. Detach the lap/shoulder belts from both sides of the seat by inserting a safety belt tongue or key into the buckle release slot, pushing upward as shown, and pulling out the mini-tongue on the end of the safety belt.

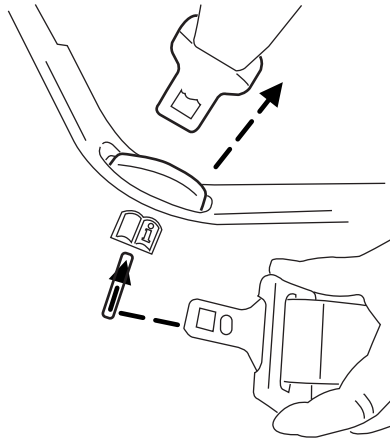

## Seating and Safety Restraints

2. Find the clips attached near the ends of the lap/shoulder belts.

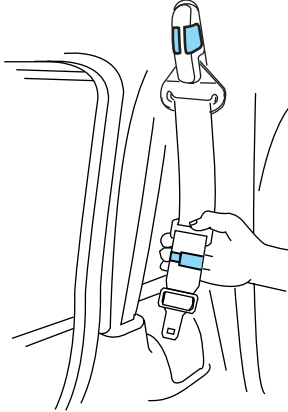

3. Clip the end of the belt to the stationary portion of the shoulder belt coming out of the trim panel.

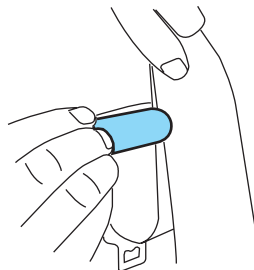

The end of the shoulder belt **must** be clipped in order to keep it from striking anything during vehicle operation.



## Seating and Safety Restraints

4. Position seatback in full down position.
5. From behind seat pull straight back on the release handles located on each side of the seat, releasing the rear floor latches.
6. Lift up the seat by the release handles to clear the floor latches and then pull the seat rearward until the front hooks have come out of the floor tubs.
7. Remove the seat.

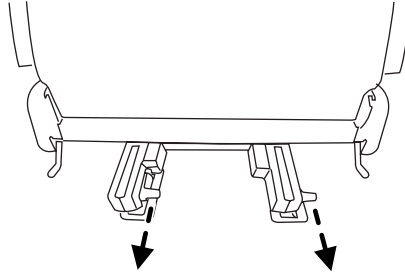

### **Installation of second row seats**

#### **Second row bucket seats**

Prior to installation, ensure that the seats are on the correct side of the vehicle. Ensure that the seat is positioned so that the safety belt buckle is near the center aisle of the vehicle. The seatback must be folded flat prior to installation.

1. Position the seat in vehicle. Place first row seat in a forward position to allow the second row seat to be installed.

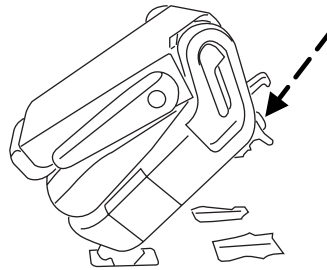



## Seating and Safety Restraints

2. Install seat onto rear pin of front tub at a 30 to 45 degree angle.

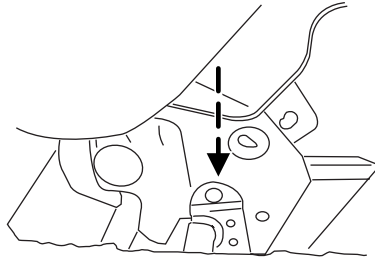

3. Rotate the seat forward until it latches onto the front pin.

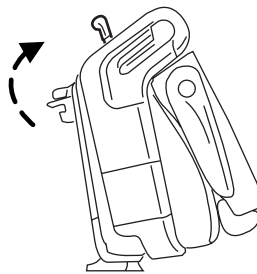

4. Rotate seat rearward until the back of the seat latches onto the floor.

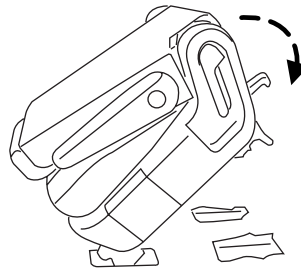

## Seating and Safety Restraints

5. Operate recline lever and push the seat back upright.

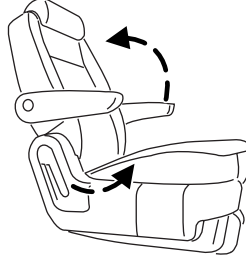

Ensure seat is latched to vehicle floor by pushing/pulling on seat. If not latched, the seat may cause injury during a sudden stop.



Before returning the seatback to its original position, make sure that cargo or any objects are not trapped behind the seatback. After returning the seatback to its original position, pull on the seatback to ensure that it has fully latched. An unlatched seat may become dangerous in the event of a sudden stop or collision.

### **Second row bench seat**

1. Position the seat in vehicle.
2. Align seat front hooks to the rear most pins of the front tub.

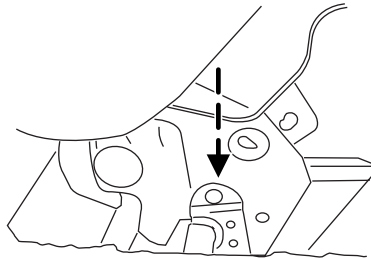

## Seating and Safety Restraints

3. Lower back of seat onto the rear tubs until both release controls latch into place. Be sure that the seat is locked in place both front and back.

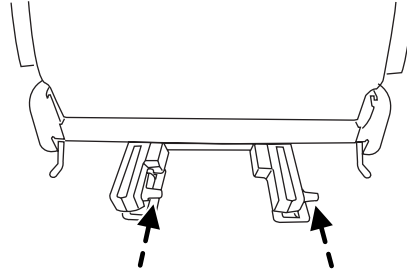

Do not place the seat front hooks on the front most pin of the front tub. Doing so will not allow the seat to fully install in vehicle.



Ensure seat is latched to vehicle floor by pushing/pulling on seat. If not latched, the seat may cause injury during a sudden stop.

### Stowing the third row seat

1. If the comfort guide is on the center lap/shoulder belt, slip the guide off the belt and stow the guide in the pocket on the back of the seat.

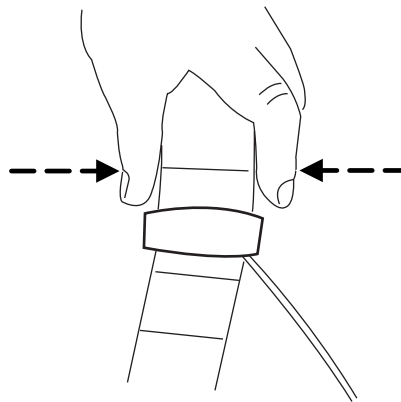

## Seating and Safety Restraints

2. If you plan to carry very large objects or items that might damage the center lap/shoulder belt, detach the belt from the seat. Use a key or safety belt tongue to release the buckle.

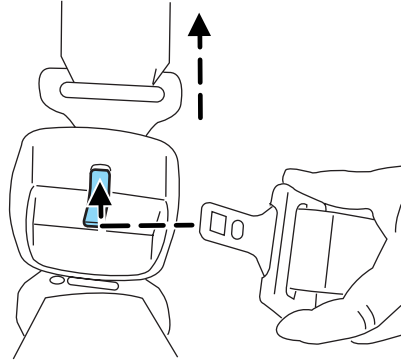

3. Store the tongue of the sliding latchplate in the belt pocket.

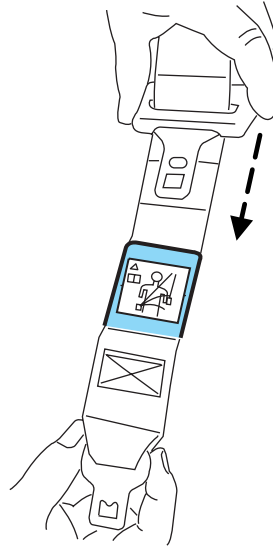

## Seating and Safety Restraints

4. Store the belt in the housing found on the ceiling by inserting the smaller tongue in the slot provided.

**Note:** The seat can be stowed with the safety belt connected if desired. Store the tongue of the sliding latchplate in the belt pocket to avoid potential damage to the seat.

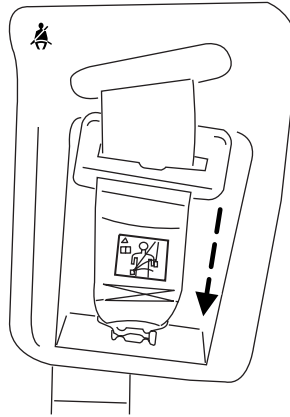

5. Push the head restraint release buttons and move the head restraints fully down. Remove all objects from the seat and stowage tub.

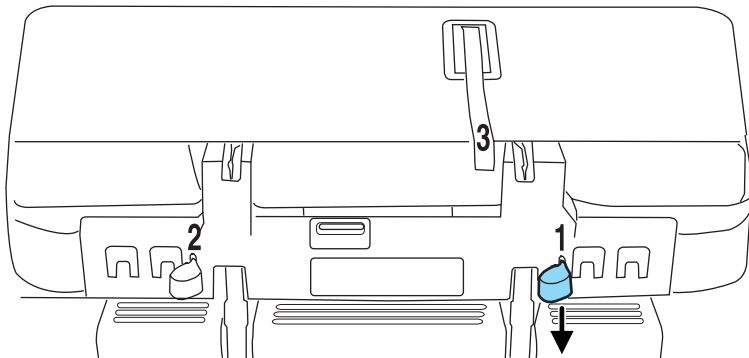

6. From the rear of the vehicle, fold seat back by **pulling and releasing** the number 1 strap.

## Seating and Safety Restraints

**Important:** If you don't let go of the number 1 strap before the seat back folds completely, the seat may not stow flat in the tub. Refer to the label attached to the rear of the vehicle seat.

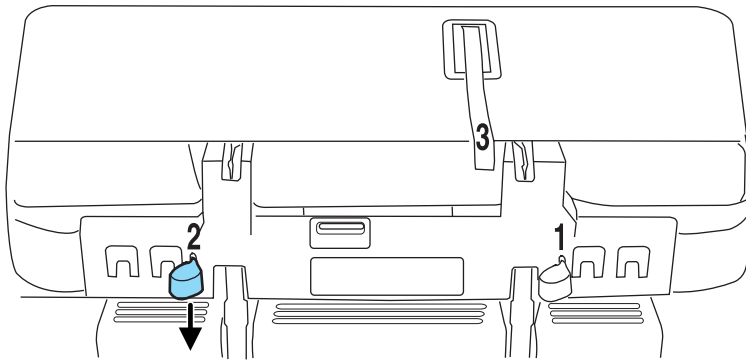
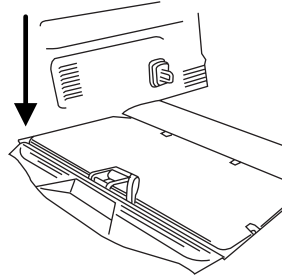

7. Release the cushion latches by pulling the number 2 strap.

## Seating and Safety Restraints

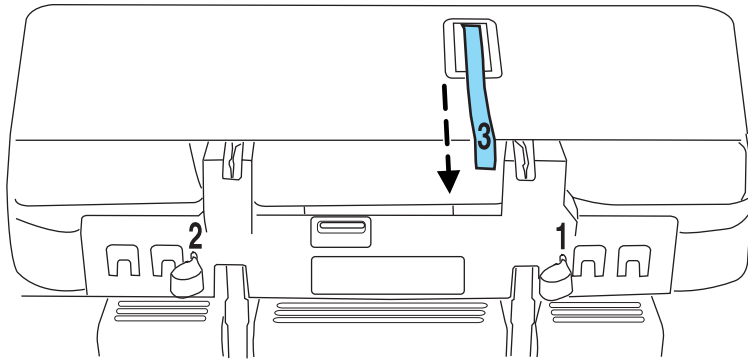

8. Pull the number 3 strap on the seat back to tumble seat all the way in to the tub in the floor.



Do not use the seat anchors as cargo tie downs.

### ***Unstowing the third row seat***

Ensure seat latching area is free of objects.

1. Lift the seat out of the tub in the floor by pulling up on the exposed strap or handle. Once seat is at a vertical position, push the seat over, letting it fall onto the latches.

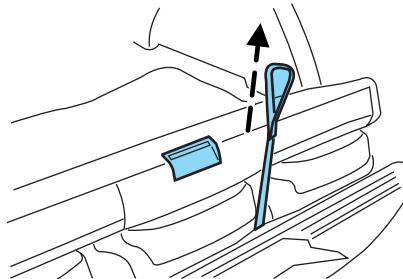

## Seating and Safety Restraints

2. To return the seat back to the seating position, pull the number 1 strap, then while holding the number 1 strap, pull the number 3 strap to raise the seat back.
3. Release the number 1 strap to allow the seat to lock, then release the number 3 strap.

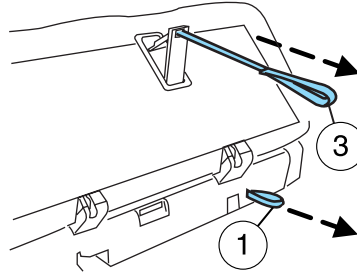

4. Pull up on the head restraints to adjust them.
5. If the center lap/shoulder belt is detached, remove the belt from the ceiling storage area just ahead of the liftgate opening and buckle the tongue on the end of the belt to the mini-buckle on the left side of the center seat.



Ensure seat is latched to vehicle floor by pushing/pulling on seat. If not latched, the seat may cause injury during a sudden stop.



Before returning the seatback to its original position, make sure that cargo or any objects are not trapped behind the seatback. After returning the seatback to its original position, pull on the seatback to ensure that it has fully latched. An unlatched seat may become dangerous in the event of a sudden stop or collision.

### **Third row seat features**

The seat is equipped with a recline function to allow for adjustment of the seat back for improved comfort. To activate the recliner, pull and hold the strap located near the plastic shield in the center of the seat. When seat is adjusted to desired location, release the strap.

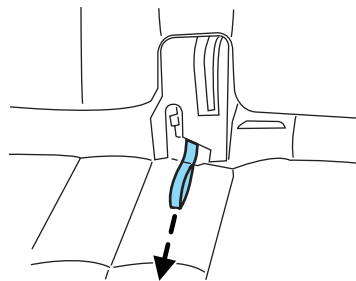



## Seating and Safety Restraints

 Reclining the seatback can cause an occupant to slide under the seat's safety belt, resulting in severe personal injuries in the event of a collision.

### **Tailgate function**

The 3rd row seat is equipped with a tailgate function to be utilized when the vehicle is parked and engine turned off. This rearward-facing position allows the customer to open the liftgate and sit facing out of the vehicle rearward.

 This is not a position suitable for driving. Do not drive the vehicle with the seat in this position. The safety belts are not functional when the seat is in the tailgate position.

Ensure head restraints are moved to their full down position, all safety belts are released from the seat, seat and stowage tub are free of objects.

1. Push the head restraint release buttons and move all head restraints fully down.

2. To access the tailgate function, the seat must be in the seating position. If the seat is not in the seating position, follow all the steps of the *Unstowing the third row seat section*. Once the seat is in the seating position, release the cushion latches by pulling the number 2 strap. Then, pull the seat rearward by the number 3 strap and set the seat on the liftgate scuff plate. The number 1 strap is not used to access this position.

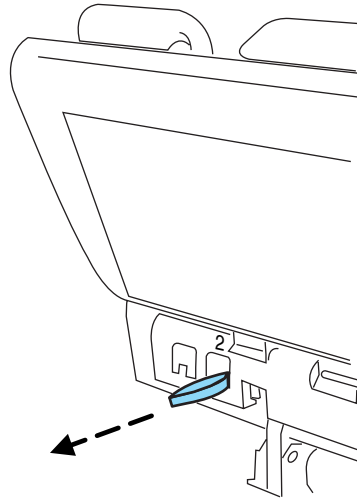

Do not sit on the head restraints.

## Seating and Safety Restraints

3. To return the seat, ensure seat latching area is free of objects. Then, raise the seat off the liftgate scuff plate and push at the top of the seat back to rotate the seat back onto the latches. Pull up on the head restraints to raise them.

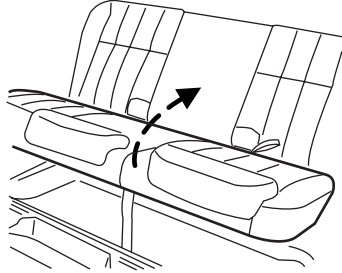

Ensure seat is latched to vehicle floor by pushing/pulling on seat. If not latched, the seat may cause injury during a sudden stop.

### SAFETY RESTRAINTS

#### Personal Safety System™

The Personal Safety System™ provides an improved overall level of frontal crash protection to front seat occupants and is designed to help further reduce the risk of airbag-related injuries. The system is able to analyze different occupant conditions and crash severity before activating the appropriate safety devices to help better protect a range of occupants in a variety of frontal crash situations.

Your vehicle's Personal Safety System™ consists of:

- Driver and passenger dual-stage airbag supplemental restraints.
- Front outboard safety belts with pretensioners, energy management retractors (first row only), and safety belt usage sensors.
- Driver's seat position sensor.
- Front passenger sensing system
- "Passenger airbag off" or "pass airbag off" indicator lamp
- Front crash severity sensor.
- Restraints Control Module (RCM) with impact and safing sensors.
- Restraint system warning light and back-up tone.
- The electrical wiring for the airbags, crash sensor(s), safety belt pretensioners, front safety belt usage sensors, driver seat position sensor, front passenger sensing system, and indicator lights.

## Seating and Safety Restraints

### ***How does the Personal Safety System™ work?***

The Personal Safety System™ can adapt the deployment strategy of your vehicle's safety devices according to crash severity and occupant conditions. A collection of crash and occupant sensors provides information to the Restraints Control Module (RCM). During a crash, the RCM activates the safety belt pretensioners and/or either one or both stages of the dual-stage airbag supplemental restraints based on crash severity and occupant conditions.

The fact that the pretensioners or airbags did not activate for both front seat occupants in a collision does not mean that something is wrong with the system. Rather, it means the Personal Safety System™ determined the accident conditions (crash severity, belt usage, etc.) were not appropriate to activate these safety devices. Front airbags are designed to activate only in frontal and near-frontal collisions (not rollovers, side impacts or rear impacts) unless the collision causes sufficient longitudinal deceleration. The pretensioners are designed to activate in frontal collisions, and in side collisions and rollovers when the vehicle is equipped with the available Safety Canopy™ system.

### ***Driver and passenger dual-stage airbag supplemental restraints***

The dual-stage airbags offer the capability to tailor the level of airbag inflation energy. A lower, less forceful energy level is provided for more common, moderate-severity impacts. A higher energy level is used for the most severe impacts. Refer to *Airbag supplemental restraints* section in this chapter.

### ***Front crash severity sensor***

The front crash severity sensor enhances the ability to detect the severity of an impact. Positioned up front, it provides valuable information early in the crash event on the severity of the impact. This allows your Personal Safety System™ to distinguish between different levels of crash severity and modify the deployment strategy of the dual-stage airbags and safety belt pretensioners.

### ***Driver's seat position sensor***

The driver's seat position sensor allows your Personal Safety System™ to tailor the deployment level of the driver dual-stage airbag based on seat position. The system is designed to help protect smaller drivers sitting close to the driver airbag by providing a lower airbag output level.

### ***Front passenger sensing system***

For airbags to do their job they must inflate with great force, and this force can pose a potentially deadly risk to occupants that are very close

## Seating and Safety Restraints

to the airbag when it begins to inflate. For some occupants, this occurs because they are initially sitting very close to the airbag. For other occupants, this occurs when the occupant is not properly restrained by safety belts or child safety seats and they move forward during pre-crash braking. The most effective way to reduce the risk of unnecessary injuries is to make sure all occupants are properly restrained. Accident statistics suggest that children are much safer when properly restrained in the rear seating positions than in the front.



Air bags can kill or injure a child in a child seat. **NEVER** place a rear-facing child seat in front of an active air bag. If you must use a forward-facing child seat in the front seat, move the seat all the way back.



Always transport children 12 years old and under in the back seat and always properly use appropriate child restraints.

The front passenger sensing system can automatically turn off the passenger front airbag. The system is designed to help protect small (child size) occupants from airbag deployments when they are improperly seated or restrained in the front passenger seat contrary to proper child-seating or restraint usage recommendations. Even with this technology, parents are **STRONGLY** encouraged to always properly restrain children in the rear seat. The sensor also turns off the passenger's front airbag, and side airbag if equipped, when the passenger seat is empty to prevent unnecessary replacement of the airbag(s) after a collision.

### **Front safety belt usage sensors**

The front safety belt usage sensors detect whether or not the driver and front outboard passenger safety belts are fastened. This information allows your Personal Safety System<sup>™</sup> to tailor the airbag deployment and safety belt pretensioner activation depending upon safety belt usage. Refer to *Safety belt* section in this chapter.

### **Front safety belt pretensioners**

The safety belt pretensioners at the front outboard seating positions are designed to tighten the safety belts firmly against the occupant's body during frontal collisions, and in side collisions and rollovers when the vehicle is equipped with the Safety Canopy<sup>™</sup> system. This helps increase the effectiveness of the safety belts. In frontal collisions, the safety belt pretensioners can be activated alone or, if the collision is of sufficient severity, together with the front airbags.

## Seating and Safety Restraints

### **Front safety belt energy management retractors**

The front outboard safety belt energy management retractors allow webbing to be pulled out of the retractor in a gradual and controlled manner in response to the occupant's forward momentum. This helps reduce the risk of force-related injuries to the occupant's chest by limiting the load on the occupant. Refer to *Energy management feature* section in this chapter.

### **Determining if the Personal Safety System is operational**

The Personal Safety System™ uses a warning light in the instrument cluster or a back-up tone to indicate the condition of the system. Refer to the *Warning light* section in the *Instrument cluster* chapter. Routine maintenance of the Personal Safety System™ is not required.

The Restraints Control Module (RCM) monitors its own internal circuits and the circuits for the airbag supplemental restraints, crash sensor(s), safety belt pretensioners, front safety belt buckle sensors, driver seat position sensor, and front passenger sensing system. In addition, the RCM also monitors the restraints warning light in the instrument cluster. A difficulty with the system is indicated by one or more of the following.

- The warning light will either flash or stay lit.
- The warning light will not illuminate immediately after ignition is turned on.
- A series of five beeps will be heard. The tone pattern will repeat periodically until the problem and warning light are repaired.

If any of these things happen, even intermittently, have the Personal Safety System™ serviced at an authorized dealer immediately. Unless serviced, the system may not function properly in the event of a collision.

### **Safety belt precautions**



Always drive and ride with your seatback upright and the lap belt snug and low across the hips.



To reduce the risk of injury, make sure children sit where they can be properly restrained.

## Seating and Safety Restraints



Never let a passenger hold a child on his or her lap while the vehicle is moving. The passenger cannot protect the child from injury in a collision.



All occupants of the vehicle, including the driver, should always properly wear their safety belts, even when an air bag supplemental restraint system (SRS) is provided.



It is extremely dangerous to ride in a cargo area, inside or outside of a vehicle. In a collision, people riding in these areas are more likely to be seriously injured or killed. Do not allow people to ride in any area of your vehicle that is not equipped with seats and safety belts. Be sure everyone in your vehicle is in a seat and using a safety belt properly.



In a rollover crash, an unbelted person is significantly more likely to die than a person wearing a seat belt.



Each seating position in your vehicle has a specific safety belt assembly which is made up of one buckle and one tongue that are designed to be used as a pair. 1) Use the shoulder belt on the outside shoulder only. Never wear the shoulder belt under the arm. 2) Never swing the safety belt around your neck over the inside shoulder. 3) Never use a single belt for more than one person.



Always transport children 12 years old and under in the back seat and always properly use appropriate child restraints.

## Seating and Safety Restraints

### Combination lap and shoulder belts

1. Insert the belt tongue into the proper buckle (the buckle closest to the direction the tongue is coming from) until you hear a snap and feel it latch. Make sure the tongue is securely fastened in the buckle.

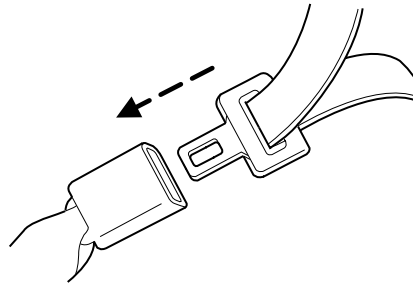

2. To unfasten, push the release button and remove the tongue from the buckle.

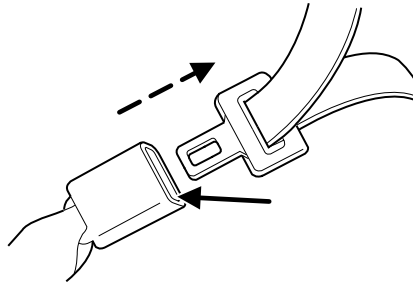

All restraints in the vehicle are combination lap and shoulder belts.

While you are fastened in the safety belt, the combination lap/shoulder belt adjusts to your movement. However, if you brake hard, turn hard, or if your vehicle receives an impact of 5 mph (8 km/h) or more, the safety belt will become locked and help reduce your forward movement.

### Energy Management Feature — Front Outboard

- This vehicle has a safety belt system with an energy management feature at the front seats to help further reduce the risk of injury in the event of a head-on collision.
- This safety belt system has a retractor assembly that is designed to extend the safety belt webbing in a controlled manner. This helps reduce the belt force acting on the user's chest.

 Failure to inspect and replace if necessary the Belt and Retractor assembly after an accident could increase the risk of injury in a collision.

## Seating and Safety Restraints

All safety restraints in the vehicle are combination lap and shoulder belts. All of the passenger combination lap and shoulder belts have two types of locking modes described below:

### Vehicle sensitive mode

This is the normal retractor mode, which allows free shoulder belt length adjustment to your movements and locking in response to vehicle movement. For example, if the driver brakes suddenly or turns a corner sharply, or the vehicle receives an impact of approximately 5 mph (8 km/h) or more, the combination safety belts will lock to help reduce forward movement of the driver and passengers.

### Automatic locking mode

#### *When to use the automatic locking mode*

In this mode, the shoulder belt is automatically pre-locked. The belt will still retract to remove any slack in the shoulder belt. The automatic locking mode is not available on the driver safety belt.

This mode should be used **any time** a child safety seat (except a booster) is installed in a passenger front or outboard rear seating position (if equipped). Children 12 years old and under should be properly restrained in the rear seat whenever possible. Refer to *Safety restraints for children* or *Safety seats for children* later in this chapter.

#### *How to use the automatic locking mode*

- Buckle the combination lap and shoulder belt.

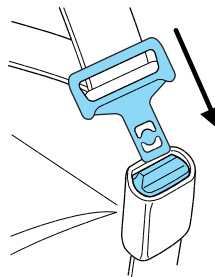



## Seating and Safety Restraints

- Grasp the shoulder portion and pull downward until the entire belt is pulled out.



- Allow the belt to retract. As the belt retracts, you will hear a clicking sound. This indicates the safety belt is now in the automatic locking mode.

### **How to disengage the automatic locking mode**



Ford Motor Company recommends that all passenger safety belt assemblies and attaching hardware should be inspected by an authorized dealer after any collision to verify that the "automatic locking retractor" feature for child seats is still working properly. Safety belt assemblies should be inspected by an authorized dealer and must be replaced if either damage or improper operation is noted. Failure to replace the belt and retractor assembly could increase the risk of injury in a collision.

Unbuckle the combination lap/shoulder belt and allow it to retract completely to disengage the automatic locking mode and activate the vehicle sensitive (emergency) locking mode.

### **Safety belt height adjustment**

Your vehicle has safety belt height adjustments at the front and second row outboard seating positions.

Adjust the height of the shoulder belt so the belt rests across the middle of your shoulder.

To adjust the shoulder belt height, squeeze and hold the buttons on the side and slide the height adjuster up or down. Release the buttons and pull down on the height adjuster to make sure it is locked in place.

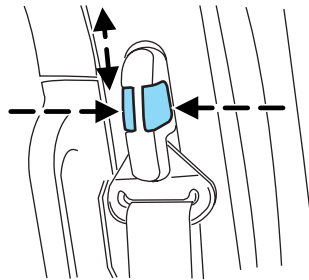

## Seating and Safety Restraints

 Position the safety belt height adjusters so that the belt rests across the middle of your shoulder. Failure to adjust the safety belt properly could reduce the effectiveness of the safety belt and increase the risk of injury in a collision.

### **Third row comfort guide**

**Note:** Before stowing the third row seat or folding the third row seat back down, the center seat lap/shoulder belt needs to either have the cross lap tongue stowed in the pocket on the belt or the entire belt needs to be stowed in the roof.

The safety belt for the 3rd row center occupant may be stowed in the ceiling if it has been detached from the seat to carry large cargo. Remove the safety belt from the stowage area on the ceiling and buckle the small tongue on the end of the safety belt to the mini-buckle on the left side of the center seat position.

The third row center lap/shoulder belt is equipped with a Belt Comfort Guide located in a pocket on the back of the seat. The guide is attached to the driver's side head restraint, and is used to adjust the comfort of the shoulder belt for smaller occupants in the center position of the 3rd row seat. To adjust the comfort guide:

- Slip the shoulder belt into the belt guide.
- Slide the guide up or down along the head restraint post so that the belt is centered on the occupant's shoulder.

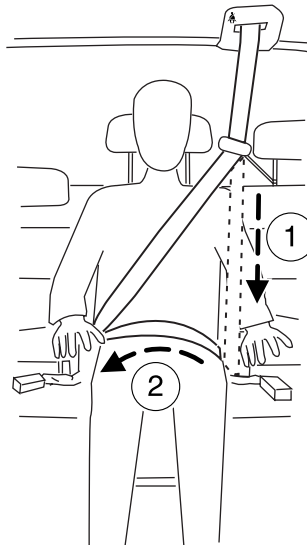

### **Safety belt extension assembly**

If the safety belt is too short when fully extended, a 9 inch (23 cm) or 12 inch (31 cm) safety belt extension assembly can be added (part

## Seating and Safety Restraints

numbers 611C22–A and 611C22–B respectively). These assemblies can be obtained from an authorized dealer.

Use only extensions manufactured by the same supplier as the safety belt. Manufacturer identification is located at the end of the webbing on the label. Also, use the safety belt extension only if the safety belt is too short for you when fully extended.



Do not use extensions to change the fit of the shoulder belt across the torso.

### Safety belt maintenance

Inspect the safety belt systems periodically to make sure they work properly and are not damaged. Inspect the safety belts to make sure there are no nicks, tears or cuts, replacing if necessary. All safety belt assemblies, including retractors, buckles, front safety belt buckle assemblies, buckle support assemblies (slide bar-if equipped), shoulder belt height adjusters (if equipped), child safety seat tether bracket assemblies (if equipped), LATCH child seat tether anchors and lower anchors (if equipped), and attaching hardware, should be inspected after a collision. Ford recommends that all safety belt assemblies in use in vehicles involved in a collision be replaced. However, if the collision was minor and an authorized dealer finds that the belts do not show damage and continue to operate properly, they do not need to be replaced, except as described in the *Replacing the front safety belt assemblies after a collision* section of this chapter. Safety belt assemblies not in use during a collision should also be inspected and replaced if either damage or improper operation is noted.



Failure to inspect and if necessary replace the safety belt assembly under the above conditions could result in severe personal injuries in the event of a collision.

Refer to *Interior* in the *Cleaning* chapter.

### Replacing the front safety belt assemblies after a collision

The front outboard safety belt assemblies have a special energy management retractors designed to further reduce the risk of injury in the event of a head-on collision. These retractors should be replaced if they were used in any accident in which the front airbags deploy. If the safety belt assemblies are not replaced, there may be increased risk of injury in the event of a subsequent collision.

## Seating and Safety Restraints



Failure to inspect and if necessary replace the safety belt assembly under the above conditions could result in severe personal injuries in the event of a collision.

### Safety belt warning light and indicator chime

The safety belt warning light illuminates in the instrument cluster and a chime sounds to remind the occupants to fasten their safety belts.

#### Conditions of operation

If...	Then...
The driver's safety belt is not buckled before the ignition switch is turned to the ON position...	The safety belt warning light illuminates 1-2 minutes and the warning chime sounds 4-8 seconds.
The driver's safety belt is buckled while the indicator light is illuminated and the warning chime is sounding...	The safety belt warning light and warning chime turn off.
The driver's safety belt is buckled before the ignition switch is turned to the ON position...	The safety belt warning light and indicator chime remain off.

#### BeltMinder®

The BeltMinder® feature is a supplemental warning to the safety belt warning function. This feature provides additional reminders by intermittently sounding a chime and illuminating the safety belt warning light in the instrument cluster when the driver's and front passenger's safety belt is unbuckled.

The BeltMinder® feature uses information from the front passenger sensing system to determine if a front seat passenger is present and therefore potentially in need of a warning. To avoid activating the BeltMinder® feature for objects placed in the front passenger seat, warnings will only be given to large front seat occupants as determined by the front passenger sensing system.

Both the driver's and passenger's safety belt usages are monitored and either may activate the BeltMinder® feature. The warnings are the same

## Seating and Safety Restraints

for the driver and the front passenger. If the BeltMinder® warnings have expired (warnings for approximately 5 minutes) for one occupant (driver or front passenger), the other occupant can still activate the BeltMinder® feature.

If...	Then...
The driver's and front passenger's safety belts are buckled before the ignition switch is turned to the ON position or less than 1-2 minutes have elapsed since the ignition switch has been turned ON...	The BeltMinder® feature will not activate.
The driver's or front passenger's safety belt is not buckled when the vehicle has reached at least 3 mph (5 km/h) and 1-2 minutes have elapsed since the ignition switch has been turned to ON...	The BeltMinder® feature is activated - the safety belt warning light illuminates and the warning chime sounds for 6 seconds every 30 seconds, repeating for approximately 5 minutes or until the safety belts are buckled.
The driver's or front passenger's safety belt becomes unbuckled for approximately 1 minute while the vehicle is traveling at least 3 mph (5 km/h) and more than 1-2 minutes have elapsed since the ignition switch has been turned to ON...	The BeltMinder® feature is activated - the safety belt warning light illuminates and the warning chime sounds for 6 seconds every 30 seconds, repeating for approximately 5 minutes or until the safety belts are buckled.

## Seating and Safety Restraints

The following are reasons most often given for not wearing safety belts  
(All statistics based on U.S. data):

Reasons given...	Consider...
"Crashes are rare events"	<b>36700 crashes occur every day.</b> The more we drive, the more we are exposed to "rare" events, even for good drivers. <i>1 in 4 of us will be seriously injured in a crash during our lifetime.</i>
"I'm not going far"	<b>3 of 4</b> fatal crashes occur within <b>25</b> miles (40 km) of home.
"Belts are uncomfortable"	We design our safety belts to enhance comfort. If you are uncomfortable - try different positions for the safety belt upper anchorage and seatback which should be as upright as possible; this can improve comfort.
"I was in a hurry"	<b>Prime time for an accident.</b> BeltMinder® reminds us to take a few seconds to buckle up.
"Safety belts don't work"	<b>Safety belts</b> , when used properly, <b>reduce risk of death</b> to front seat occupants by <b>45% in cars</b> , and by <b>60% in light trucks</b> .
"Traffic is light"	<b>Nearly 1 of 2 deaths occur in single-vehicle crashes</b> , many when no other vehicles are around.
"Belts wrinkle my clothes"	Possibly, but a serious crash can do much more than wrinkle your clothes, particularly if you are unbelted.
"The people I'm with don't wear belts"	Set the example, teen deaths occur 4 times more often in vehicles with TWO or MORE people. Children and younger brothers/sisters imitate behavior they see.

## Seating and Safety Restraints

Reasons given...	Consider...
"I have an airbag"	Airbags offer greater protection when used with safety belts. Frontal airbags are not designed to inflate in rear and side crashes or rollovers.
"I'd rather be thrown clear"	Not a good idea. <b>People</b> who are <b>ejected are 40 times more likely to DIE.</b> Safety belts help prevent ejection, WE CAN'T "PICK OUR CRASH".



Do not sit on top of a buckled safety belt or insert a latchplate into the buckle to avoid the BeltMinder® chime. To do so may adversely affect the performance of the vehicle's air bag system.

### **One time disable**

If at any time the driver/front passenger quickly buckles then unbuckles the safety belt for that seating position, the BeltMinder® is disabled for the current ignition cycle. The BeltMinder® feature will enable during the same ignition cycle if the occupant buckles and remains buckled for approximately 30 seconds. Confirmation is not given for the one time disable.

### **Deactivating/activating the BeltMinder® feature**

**The driver and front passenger BeltMinder® are deactivated/activated independently. When deactivating/activating one seating position, do not buckle the other position as this will terminate the process.**

*Read Steps 1 - 4 thoroughly before proceeding with the deactivation/activation programming procedure.*

**Note:** The driver and front passenger BeltMinder® features must be disabled/enabled separately. Both cannot be disabled/enabled during the same key cycle.

The driver and front passenger BeltMinder® features can be deactivated/activated by performing the following procedure:

Before following the procedure, make sure that:

- The parking brake is set
- The gearshift is in P (Park) (automatic transmission)

## Seating and Safety Restraints

- The ignition switch is in the OFF position
- The driver and front passenger safety belts are unbuckled



While the design allows you to deactivate your BeltMinder®, this system is designed to improve your chances of being safely belted and surviving an accident. We recommend you leave the BeltMinder® system activated for yourself and others who may use the vehicle. To reduce the risk of injury, do not deactivate/activate the BeltMinder® feature while driving the vehicle.

1. Turn the ignition switch to the RUN (or ON) position. (DO NOT START THE ENGINE)
2. Wait until the safety belt warning light turns off. (Approximately 1 minute)
  - Step 3 must be completed within 50 seconds after the safety belt warning light turns off.
3. For the seating position being disabled, at a moderate speed, buckle then unbuckle the safety belt 9 times, ending in the unbuckled state. (Step 3 must be completed within 50 seconds after the safety belt warning light turns off.)
  - After Step 3, the restraint system warning light (airbag light) will be turned on for three seconds.
4. Within 10 seconds of the light turning on, at a moderate speed, buckle then unbuckle the safety belt.
  - This will disable the BeltMinder® feature for that seating position if it is currently enabled. As confirmation, the restraint system warning light will flash 4 times per second for 3 seconds.
  - This will enable the BeltMinder® feature for that seating position if it is currently disabled. As confirmation, the restraint system warning light will flash 4 times per second for 3 seconds, followed by 3 seconds with the light off, then followed by the restraint system warning light flashing 4 times per second for 3 seconds again.



## Seating and Safety Restraints

### AIRBAG SUPPLEMENTAL RESTRAINT SYSTEM (SRS)

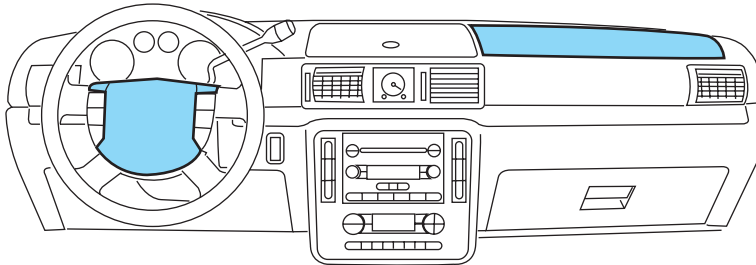

The airbag supplemental restraint system (SRS) is designed to work in conjunction with the safety belts to help protect the driver and front outboard passenger from certain upper body injuries. The term “supplemental restraint” means the airbags are intended as a supplement to the safety belts. Airbags alone cannot protect as well as airbags plus safety belts in impacts for which the airbags are designed to deploy, and airbags do not offer any protection in crashes for which they do not deploy.

#### Important SRS precautions

The SRS is designed to work with the safety belt to help protect the driver and right front passenger from certain upper body injuries. Airbags DO NOT inflate slowly; there is a risk of injury from a deploying airbag.

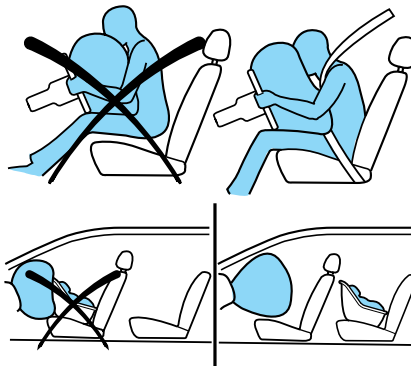

 All occupants of the vehicle, including the driver, should always properly wear their safety belts, even when an air bag supplemental restraint system (SRS) is provided.

## Seating and Safety Restraints



Always transport children 12 years old and under in the back seat and always properly use appropriate child restraints.



The National Highway Traffic Safety Administration (NHTSA) recommends a minimum distance of at least 10 inches (25 cm) between an occupant's chest and the driver airbag module.



Never place your arm over the airbag module as a deploying airbag can result in serious arm fractures or other injuries.

To properly position yourself away from the airbag:

- Move your seat to the rear as far as you can while still reaching the pedals comfortably.
- Recline the seat slightly one or two degrees from the upright position.



Do not put anything on or over the airbag module. Placing objects on or over the airbag inflation area may cause those objects to be propelled by the airbag into your face and torso causing serious injury.



Do not attempt to service, repair, or modify the airbag supplemental restraint systems or its fuses. See your authorized dealer.



Modifying or adding equipment to the front end of the vehicle (including frame, bumper, front end body structure and tow hooks) may affect the performance of the airbag system, increasing the risk of injury. Do not modify the front end of the vehicle.

## Seating and Safety Restraints

### Children and airbags

Children must always be properly restrained. Accident statistics suggest that children are safer when properly restrained in the rear seating positions than in the front seating position. Failure to follow these instructions may increase the risk of injury in a collision.

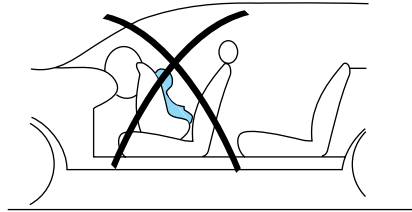

Airbags can kill or injure a child in a child seat.

**NEVER** place a rear-facing child seat in front of an active airbag. If you must use a forward-facing child seat in the front seat, move the seat all the way back.

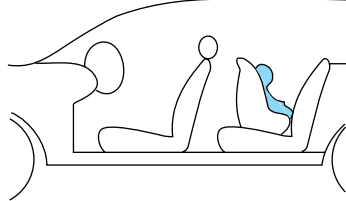

### How does the airbag supplemental restraint system work?

The airbag SRS is designed to activate when the vehicle sustains longitudinal deceleration sufficient to cause the sensors to close an electrical circuit that initiates airbag inflation. The fact that the airbags did not inflate in a collision does not mean that something is wrong with the system. Rather, it means the forces were not of the type sufficient to cause activation. Front airbags are designed to inflate in frontal and near-frontal collisions, not rollover, side-impact, or rear-impacts unless the collision causes sufficient longitudinal deceleration.

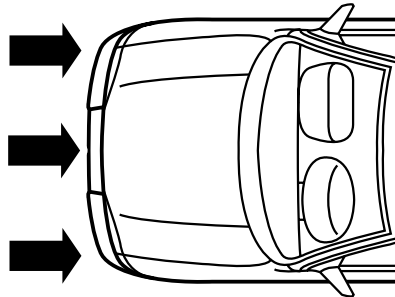

## Seating and Safety Restraints

The airbags inflate and deflate rapidly upon activation. After airbag deployment, it is normal to notice a smoke-like, powdery residue or smell the burnt propellant. This may consist of cornstarch, talcum powder (to lubricate the bag) or sodium compounds (e.g., baking soda) that result from the combustion process that inflates the airbag. Small amounts of sodium hydroxide may be present which may irritate the skin and eyes, but none of the residue is toxic.



While the system is designed to help reduce serious injuries, contact with a deploying airbag may also cause abrasions, swelling or temporary hearing loss. Because airbags must inflate rapidly and with considerable force, there is the risk of death or serious injuries such as fractures, facial and eye injuries or internal injuries, particularly to occupants who are not properly restrained or are otherwise out of position at the time of airbag deployment. Thus, it is extremely important that occupants be properly restrained as far away from the airbag module as possible while maintaining vehicle control.



Several air bag system components get hot after inflation. Do not touch them after inflation.



If the air bag has deployed, **the air bag will not function again and must be replaced immediately.** If the air bag is not replaced, the unrepaired area will increase the risk of injury in a collision.

The SRS consists of:

- driver and passenger airbag modules (which include the inflators and airbags).
- side airbags (if equipped). Refer to *Side airbag system* later in this chapter.
- Safety Canopy<sup>™</sup> system (if equipped). Refer to *Safety canopy system* later in this chapter.

156

## Seating and Safety Restraints

- one or more impact and safing sensors.
- Safety belt pretensioner
- a readiness light and tone.
- diagnostic module.
- and the electrical wiring which connects the components.
- Front passenger sensing system. Refer to *Front passenger sensing system*. later in this chapter.
- “Passenger airbag off” or “pass airbag off” indicator lamp. Refer to *Front passenger sensing system*. later in this chapter.

The diagnostic module monitors its own internal circuits and the supplemental airbag electrical system wiring (including the impact sensors), the system wiring, the airbag system readiness light, the airbag back up power and the airbag ignitors.

### Front passenger sensing system

The front passenger sensing system is designed to meet the regulatory requirements of Federal Motor Vehicle Safety Standard (FMVSS) 208 and is designed to disable (will not inflate) the front passenger’s frontal airbag under certain conditions.

The front passenger sensing system works with sensors that are part of the front passenger’s seat and safety belt. The sensors are designed to detect the presence of a properly seated occupant and determine if the front passenger’s frontal airbag should be enabled (may inflate) or disabled (will not inflate).

The front passenger sensing system will disable (will not inflate) the front passenger’s frontal airbag if:

- the front passenger seat is unoccupied, or has small/medium objects in the front seat,
- the system determines that an infant is present in a rear-facing infant seat that is installed according to the manufacturer’s instructions,
- the system determines that a small child is present in a forward-facing child restraint that is installed according to the manufacturer’s instructions,
- the system determines that a small child is present in a booster seat,
- a front passenger takes his/her weight off of the seat for a period of time,
- a child or a small person occupies the front passenger seat.

## Seating and Safety Restraints

For side airbag equipped vehicles, the front passenger sensing system will turn off the passenger seat side airbag if:

- the seat is empty and safety belt is unbuckled.

The front passenger sensing system uses a "passenger airbag off" or "pass airbag off" indicator which will illuminate and stay lit to remind you that the front passenger frontal airbag is disabled. The indicator lamp is located in the center stack of the instrument panel to the right of the radio.

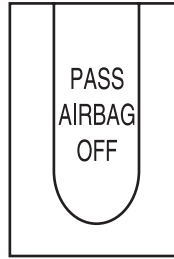

**Note:** The indicator lamp will illuminate for a short period of time when the ignition is turned to the ON position to confirm it is functional.

When the front passenger seat is not occupied (empty seat) or in the event that the front passenger frontal airbag is enabled (may inflate), the indicator lamp will be unlit.

The front passenger sensing system is designed to disable (will not inflate) the front passenger's frontal airbag when a rear facing infant seat, a forward-facing child restraint, or a booster seat is detected.

- When the front passenger sensing system disables (will not inflate) the front passenger frontal airbag, the indicator lamp will illuminate and stay lit to remind you that the front passenger frontal airbag is disabled.
- If the child restraint has been installed and the indicator lamp is not lit, then turn the vehicle off, remove the child restraint from the vehicle and reinstall the restraint following the child restraint manufacturer's instructions.

The front passenger sensing system is designed to enable (may inflate) the front passenger's frontal airbag anytime the system senses that a person of adult size is sitting properly in the front passenger seat.

- When the front passenger sensing system enables the front passenger frontal airbag (may inflate), the indicator will be unlit and stay unlit.

If a person of adult size is sitting in the front passenger's seat, but the "passenger airbag off" or "pass airbag off" indicator lamp is lit, it is possible that the person isn't sitting properly in the seat. If this happens:

- Turn the vehicle off and ask the person to place the seatback in the full upright position.

## Seating and Safety Restraints

- Have the person sit upright in the seat, centered on the seat cushion, with the person's legs comfortably extended.
- Restart the vehicle and have the person remain in this position for about two minutes. This will allow the system to detect that person and enable the passenger's frontal airbag.
- If the indicator lamp remains lit even after this, the person should be advised to ride in the rear seat.

Occupant	Pass Airbag Off Indicator Lamp	Passenger Airbag
Empty seat	Unlit	Disabled
Small child in child safety seat or booster	Lit	Disabled
Small child with safety belt buckled or unbuckled	Lit	Disabled
Adult	Unlit	Enabled



Even with Advanced Restraints Systems, children 12 and under should be properly restrained in the back seat.

After all occupants have adjusted their seats and put on safety belts, it's very important that they continue to sit properly. A properly seated occupant sits upright, leaning against the seat back, and centered on the seat cushion, with their feet comfortably extended on the floor. Sitting improperly can increase the chance of injury in a crash event. For example, if an occupant slouches, lies down, turns sideways, sits forward, leans forward or sideways, or puts one or both feet up, the chance of injury during a crash is greatly increased.



Sitting improperly out of position or with the seat back reclined too far can take off weight from the seat cushion and affect the decision of the front passenger sensing system, resulting in serious injury or death in a crash. Always sit upright against your seatback, with your feet on the floor.

The front passenger sensing system may detect small or medium objects placed on the seat cushion. For most objects that are in the front passenger seat, the passenger airbag will be disabled. Even though the passenger airbag is disabled, the "pass airbag off" lamp may or may not be illuminated according to the table below.

## Seating and Safety Restraints

Objects	Pass Airbag Off Indicator Lamp	Passenger Airbag
Small (i.e. 3 ring binder, small purse, bottled water)	Unlit	Disabled
Medium (i.e. heavy briefcase, fully packed luggage)	Lit	Disabled
Empty seat, or small to medium object with safety belt buckled	Lit	Disabled

If you think that the status of the passenger airbag off indicator lamp is incorrect, check for the following:

- Objects lodged underneath the seat
- Objects between the seat cushion and the center console (if equipped)
- Objects hanging off the seat back
- Objects stowed in the seatback map pocket (if equipped)
- Objects placed on the occupant's lap
- Cargo interference with the seat
- Other passengers pushing or pulling on the seat
- Rear passenger feet and knees resting or pushing on the seat

The conditions listed above may cause the weight of a properly seated occupant to be incorrectly interpreted by the passenger sensing system. The person in the front passenger seat may appear heavier or lighter due to the conditions described in the list above.



To reduce the risk of possible serious injury:

Do not stow objects in seat back map pocket (if equipped) or hang objects off seat back if a child is in the front passenger seat. Do not place objects underneath the front passenger seat or between the seat and the center console (if equipped). Check the "passenger airbag off" or "pass airbag off" indicator lamp for proper airbag status. Failure to follow these instructions may interfere with the front passenger seat sensing system.



## Seating and Safety Restraints

In case there is a problem with the front passenger sensing system, the airbag readiness lamp in the instrument cluster will stay lit.



### **If the airbag readiness lamp is lit, do the following:**

The driver and/or adult passengers should check for any objects that may be lodged underneath the front passenger seat or cargo interfering with the seat.

If objects are lodged and/or cargo is interfering with the seat; please take the following steps to remove the obstruction:

- Pull the vehicle over.
- Turn the vehicle off.
- Driver and/or adult passengers should check for any objects lodged underneath the front passenger seat or cargo interfering with the seat.
- Remove the obstruction(s) (if found).
- Restart the vehicle.
- Wait at least 2 minutes and verify that the airbag readiness light is no longer illuminated
- If the airbag readiness lamp remains illuminated, this may or may/not be a problem due to the front passenger sensing system.

DO NOT attempt to repair or service the system; take your vehicle immediately to an authorized dealer.

If it is necessary to modify an advanced front airbag system to accommodate a person with disabilities, contact the Ford Customer Relationship Center at the phone number shown in the *Customer Assistance* chapter of this *Owner's Guide*.



Any alteration/modification to the front passenger seat may affect the performance of the front passenger sensing system.

### **Determining if the system is operational**

The supplemental restraint system uses a warning indicator light in the instrument cluster or a back-up tone to indicate the condition of the system. Refer to the *Warning lights and chimes* section in the *Instrument Cluster* chapter. Routine maintenance of the airbag is not required.

## Seating and Safety Restraints

A difficulty with the system is indicated by one or more of the following:

- The readiness light (same light for front and side airbag system) will either flash or stay lit.
- The readiness light will not illuminate immediately after ignition is turned on.
- A series of five beeps will be heard. The tone pattern will repeat periodically until the problem and/or light are repaired.



If any of these things happen, even intermittently, have the supplemental restraint system serviced at an authorized dealer immediately. Unless serviced, the system may not function properly in the event of a collision.

### Seat-mounted side airbag system (if equipped)



Do not place objects or mount equipment on or near the airbag cover on the side of the seatbacks of the front seats or in front seat areas that may come into contact with a deploying airbag. Failure to follow these instructions may increase the risk of personal injury in the event of a collision.



Do not use accessory seat covers. The use of accessory seat covers may prevent the deployment of the side airbags and increase the risk of injury in an accident.



Do not lean your head on the door. The side airbag could injure you as it deploys from the side of the seatback.



Do not attempt to service, repair, or modify the airbag SRS, its fuses or the seat cover on a seat containing an airbag. See your authorized dealer.



All occupants of the vehicle should always wear their safety belts even when an airbag SRS is provided.

## Seating and Safety Restraints

### **How does the side airbag system work?**

The design and development of the side airbag system included recommended testing procedures that were developed by a group of automotive safety experts known as the Side Airbag Technical Working Group. These recommended testing procedures help reduce the risk of injuries related to the deployment of side airbags.

The front passenger sensing system will disable the side airbag if the seat is empty.

The side airbag system consists of the following:

- An inflatable nylon bag (airbag) with a gas generator concealed behind the outboard bolster of the driver and front passenger seatbacks.
- A special seat cover designed to allow airbag deployment.
- The same readiness airbag light, electronic control and diagnostic unit as used for the front airbags.
- Two crash sensors located under the outboard side of the front seats, attached to the floor.

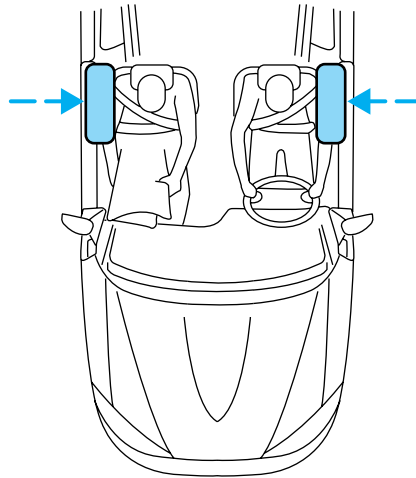

Side airbags, in combination with safety belts, can help reduce the risk of severe injuries in the event of a significant side impact collision.

The side airbags are fitted on the outboard side of the seatbacks of the front seats. In certain lateral collisions, the airbag on the side affected by the collision will be inflated, even if the respective seat is not occupied. The airbag was designed to inflate between the door panel and occupant to further enhance the protection provided occupants in side impact collisions.

The airbag SRS is designed to activate when the vehicle sustains lateral deceleration sufficient to cause the sensors to close an electrical circuit that initiates airbag inflation.

The fact that the airbags did not inflate in a collision does not mean that something is wrong with the system. Rather, it means the forces were not of the type sufficient to cause activation. Side airbags are designed

## Seating and Safety Restraints

to inflate in side-impact collisions, not roll-over, rear-impact, frontal or near-frontal collisions, unless the collision causes sufficient lateral deceleration.



Several air bag system components get hot after inflation. Do not touch them after inflation.



If the side airbag has deployed, **the airbag will not function again. The side airbag system (including the seat) must be inspected and serviced by an authorized dealer.** If the airbag is not replaced, the unrepaired area will increase the risk of injury in a collision.

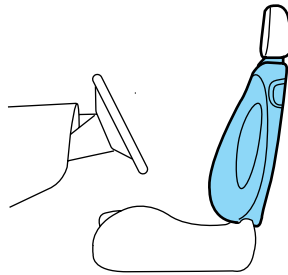

### Safety Canopy™ system (if equipped)



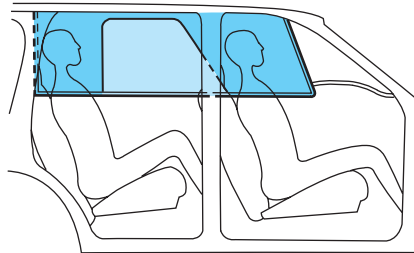

Do not place objects or mount equipment on or near the headliner at the siderail that may come into contact with a deploying Safety Canopy™. Failure to follow these instructions may increase the risk of personal injury in the event of a collision.



Do not lean your head on the door. The Safety Canopy™ could injure you as it deploys from the headliner.

## Seating and Safety Restraints

 Do not attempt to service, repair, or modify the Safety Canopy™ system, its fuses, the A, B, C or D pillar trim, or the headliner on a vehicle containing a Safety Canopy™. See your authorized dealer.

 All occupants of the vehicle including the driver should always wear their safety belts even when an airbag SRS and Safety Canopy™ system is provided.

 To reduce risk of injury, do not obstruct or place objects in the deployment path of the inflatable Safety Canopy™.

### **How does the Safety Canopy™ system work?**

The design and development of the Safety Canopy™ system included recommended testing procedures that were developed by a group of automotive safety experts known as the Side Airbag Technical Working Group. These recommended testing procedures help reduce the risk of injuries related to the deployment of side airbags (including the Safety Canopy™).

The Safety Canopy™ system consists of the following:

- An inflatable nylon curtain with a gas generator concealed behind the headliner and above the doors (one on each side of vehicle).
- A headliner designed to flex open above the side doors to allow Safety Canopy™ deployment.
- The same readiness airbag light, electronic control and diagnostic unit as used for the front airbags.
- Two crash sensors mounted under the front seats (one on each side).

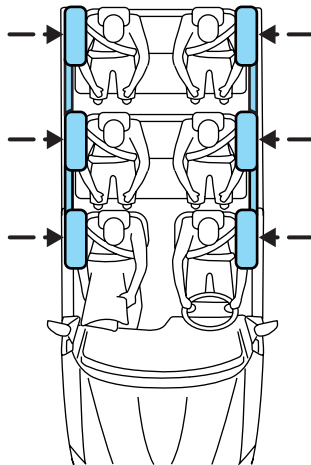

## Seating and Safety Restraints

- Two crash sensors located at the c-pillar behind the rear doors (one on each side).
- Rollover sensor in the restraints control module (RCM).

The Safety Canopy<sup>™</sup> system, in combination with safety belts, can help reduce the risk of severe injuries in the event of a significant side impact collision or rollover event.

Children 12 years old and under should always be properly restrained in the second or third row seats. The Safety Canopy<sup>™</sup> will not interfere with children restrained using a properly installed child or booster seat because it is designed to inflate downward from the headliner above the doors along the side window opening.

The Safety Canopy<sup>™</sup> system is designed to activate when the vehicle sustains lateral deceleration sufficient to cause the side crash sensor to close an electrical circuit that initiates Safety Canopy<sup>™</sup> inflation or when a certain likelihood of a rollover event is detected by the rollover sensor.

The Safety Canopy<sup>™</sup> is mounted to roof side-rail sheet metal, behind the headliner, along the entire side of the vehicle. In certain lateral collisions or rollover events, the Safety Canopy<sup>™</sup> system will be activated, regardless of which seats are occupied. The Safety Canopy<sup>™</sup> is designed to inflate between the side window area and occupants to further enhance protection provided in side impact collisions and rollover events.

The fact that the Safety Canopy<sup>™</sup> did not activate in a collision does not mean that something is wrong with the system. Rather, it means the forces were not of the type sufficient to cause activation. The Safety Canopy<sup>™</sup> is designed to inflate in certain side impact collisions or rollover events, not in rear impact, frontal or near-frontal collisions, unless the collision causes sufficient lateral deceleration or rollover.



Several Safety Canopy<sup>™</sup> system components get hot after inflation. Do not touch them after inflation.

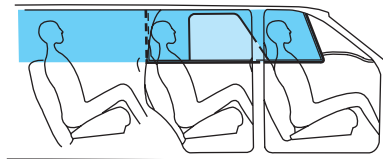

## Seating and Safety Restraints



If the Safety Canopy™ system has deployed, **the Safety Canopy™ will not function again unless replaced. The Safety Canopy™ system (including the A, B, C, and D pillar trim) must be inspected and serviced by an authorized dealer.** If the Safety Canopy™ is not replaced, the unrepaired area will increase the risk of injury in a collision.

### ***Determining if the system is operational***

The SRS uses a readiness light in the instrument cluster or a tone to indicate the condition of the system. Refer to the *Airbag readiness* section in the *Instrument Cluster* chapter. Routine maintenance of the airbag is not required.

Any difficulty with the system is indicated by one or more of the following:

- The readiness airbag light (same light as for front airbag system) will either flash or stay lit.
- The readiness light will not illuminate immediately after ignition is turned on.
- A series of five beeps will be heard. The tone pattern will repeat periodically until the problem and light are repaired.

If any of these things happen, even intermittently, have the SRS serviced at your authorized dealer immediately. Unless serviced, the system may not function properly in the event of a collision or rollover event.

### **Disposal of airbags and airbag equipped vehicles (including pretensioners)**

See your authorized dealer. Airbags MUST BE disposed of by qualified personnel.

### **SAFETY RESTRAINTS FOR CHILDREN**

See the following sections for directions on how to properly use safety restraints for children. Also see *Airbag supplemental restraint system (SRS)* in this chapter for special instructions about using airbags.

### **Important child restraint precautions**

You are required by law to use safety restraints for children in the U.S. and Canada. If small children (generally children who are four years old

## Seating and Safety Restraints

or younger and who weigh 40 lb. [18 kg] or less) ride in your vehicle, you must put them in safety seats made especially for children. Many states require that children use approved booster seats until they are eight years old. Check your local and state or provincial laws for specific requirements regarding the safety of children in your vehicle. When possible, always place children under age 12 in the rear seat of your vehicle. Accident statistics suggest that children are safer when properly restrained in the rear seating positions than in the front seating position.



Never let a passenger hold a child on his or her lap while the vehicle is moving. The passenger cannot protect the child from injury in a collision.

Always follow the instructions and warnings that come with any infant or child restraint you might use.

### Children and safety belts

If the child is the proper size, restrain the child in a safety seat. Children who are too large for child safety seats (as specified by your child safety seat manufacturer) should always wear safety belts.

Follow all the important safety restraint and airbag precautions that apply to adult passengers in your vehicle.

If the shoulder belt portion of a combination lap and shoulder belt can be positioned so it does not cross or rest in front of the child's face or neck, the child should wear the lap and shoulder belt. Moving the child closer to the center of the vehicle may help provide a good shoulder belt fit.



Do not leave children, unreliable adults, or pets unattended in your vehicle.

### Child booster seats

Children outgrow a typical convertible or toddler seat when they weigh 40 lb. (18 kg) and are around 4 years of age. Although the lap/shoulder belt will provide some protection, these children are still too small for lap/shoulder belts to fit properly, which could increase the risk of serious injury in a crash.

To improve the fit of both the lap and shoulder belt on children who have outgrown child safety seats, Ford Motor Company recommends use of a belt-positioning booster.



## Seating and Safety Restraints

Booster seats position a child so that safety belts fit better. They lift the child up so that the lap belt rests low across the hips and the knees bend comfortably. Booster seats may also make the shoulder belt fit better and more comfortably. Try to keep the belt near the middle of the shoulder.

### **When children should use booster seats**

Children need to use booster seats from the time they outgrow the toddler seat until they are big enough for the vehicle seat and lap/shoulder belt to fit properly. Generally this is when they weigh about 80 lb. (36 kg) (about 8 to 12 years old).

Booster seats should be used until you can answer YES to ALL of these questions:

- Can the child sit all the way back against the vehicle seat back with knees bent comfortably at the edge of the seat without slouching?

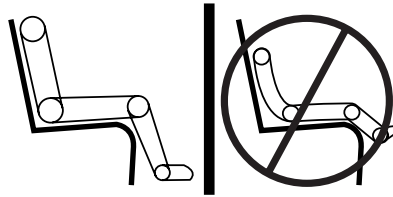

- Does the lap belt rest low across the hips?
- Is the shoulder belt centered on the shoulder and chest?
- Can the child stay seated like this for the whole trip?

### **Types of booster seats**

There are two types of belt-positioning booster seats:

- Those that are backless.

If your backless booster seat has a removable shield, remove the shield and use the lap/shoulder belt. If a seating position has a low seat back and no head restraint, a backless booster seat may place your child's head (top of ear level) above the top of the seat. In this case, move the backless booster to another seating position with a higher seat back and lap/shoulder belts.



## Seating and Safety Restraints

- Those with a high back.

If, with a backless booster seat, you cannot find a seating position that adequately supports your child's head, a high back booster seat would be a better choice.



Either type can be used at any seating position equipped with lap/shoulder belts if your child is over 40 lb. (18 kg).

Children and booster seats vary widely in size and shape. Choose a booster that keeps the lap belt low and snug across the hips, never up across the stomach, and lets you adjust the shoulder belt to cross the chest and rest snugly near the center of the shoulder. The drawings below compare the ideal fit (center) to a shoulder belt uncomfortably close to the neck and a shoulder belt that could slip off the shoulder.

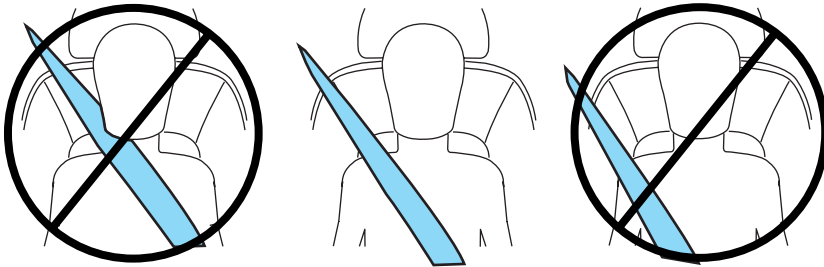

If the booster seat slides on the vehicle seat, placing a rubberized mesh sold as shelf or carpet liner under the booster seat may improve this condition.

### ***The importance of shoulder belts***

Using a booster without a shoulder belt increases the risk of a child's head hitting a hard surface in a collision. For this reason, you should never use a booster seat with a lap belt only. It is best to use a booster seat with lap/shoulder belts in the back seat- the safest place for children to ride.

## Seating and Safety Restraints



Move a child to a different seating location if the shoulder belt does not stay positioned on the shoulder during use.



Follow all instructions provided by the manufacturer of the booster seat.



Never put the shoulder belt under a child's arm or behind the back because it eliminates the protection for the upper part of the body and may increase the risk of injury or death in a collision.



Never use pillows, books, or towels to boost a child. They can slide around and increase the likelihood of injury or death in a collision.

### SAFETY SEATS FOR CHILDREN

#### Child and infant or child safety seats

Use a safety seat that is recommended for the size and weight of the child. Carefully follow all of the manufacturer's instructions with the safety seat you put in your vehicle. If you do not install and use the safety seat properly, the child may be injured in a sudden stop or collision.

## Seating and Safety Restraints

When installing a child safety seat:

- Review and follow the information presented in the *Airbag Supplemental Restraint System* section in this chapter.
- Use the correct safety belt buckle for that seating position.
- Insert the belt tongue into the proper buckle until you hear a snap and feel it latch. Make sure the tongue is securely fastened in the buckle.
- Keep the buckle release button pointing up and away from the safety seat, with the tongue between the child seat and the release button, to prevent accidental unbuckling.
- Place seat back in upright position.
- LATCH lower anchors are recommended for use by children up to 48 pounds (22 kg) in a child restraint. Top tether anchors can be used for children up to 60 pounds (27 kg) in a child restraint, and to provide upper torso restraint for children up to 80 pounds (36 kg) using an upper torso harness and a belt-positioning booster.

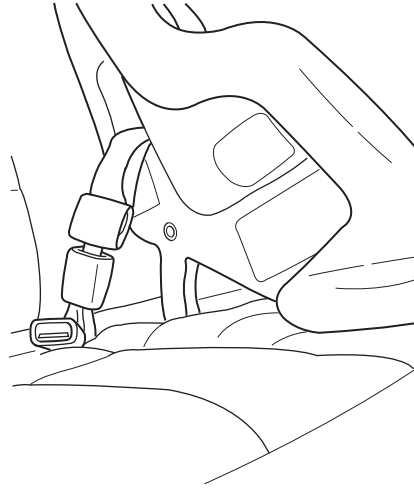

Ford recommends the use of a child safety seat having a top tether strap. Install the child safety seat in a seating position with LATCH and tether anchors. For more information on top tether straps and anchors, refer to *Attaching safety seats with tether straps* in this chapter. For more information of LATCH anchors refer to *Attaching safety seats with LATCH (Lower Anchors and Tethers for Children) attachments* in this chapter.



Carefully follow all of the manufacturer's instructions included with the safety seat you put in your vehicle. If you do not install and use the safety seat properly, the child may be injured in a sudden stop or collision.

## Seating and Safety Restraints

### Installing child safety seats with combination lap and shoulder belts

 Airbags can kill or injure a child in a child seat. **NEVER** place a rear-facing child seat in front of an active airbag. If you must use a forward-facing child seat in the front seat, move the seat all the way back.

 Children 12 and under should be properly restrained in the rear seat whenever possible.

1. Position the child safety seat in a seat with a combination lap and shoulder belt.

If you use the 3rd row center seat and the safety belt has been detached from the seat to carry large cargo, remove the safety belt from the stowage area on the ceiling and buckle the small tongue on the end of the belt to the mini-buckle on the left side of the center seat position.

2. Pull down on the shoulder belt and then grasp the shoulder belt and lap belt together.

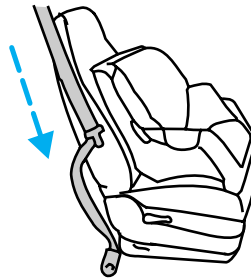
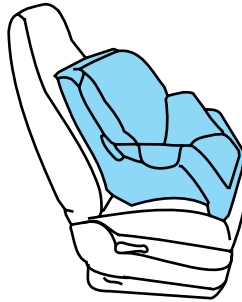

## Seating and Safety Restraints

3. While holding the shoulder and lap belt portions together, route the tongue through the child seat according to the child seat manufacturer's instructions. Be sure the belt webbing is not twisted.

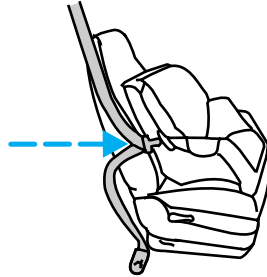

4. Insert the belt tongue into the proper buckle (the buckle closest to the direction the tongue is coming from) for that seating position until you hear a snap and feel the latch engage. Make sure the tongue is latched securely by pulling on it.

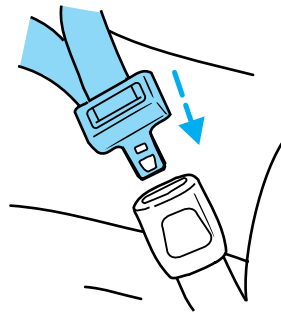

5. To put the retractor in the automatic locking mode, grasp the shoulder portion of the belt and pull downward until all of the belt is pulled out and a click is heard.

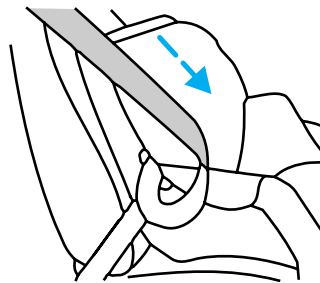

6. Allow the belt to retract. The belt will click as it retracts to indicate it is in the automatic locking mode.

## Seating and Safety Restraints

7. Pull the lap belt portion across the child seat toward the buckle and pull up on the shoulder belt while pushing down with your knee on the child seat.

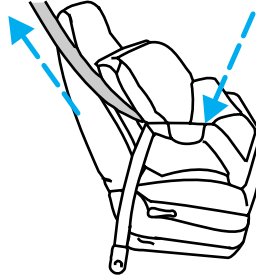

8. Allow the safety belt to retract to remove any slack in the belt.

9. Before placing the child in the seat, forcibly move the seat forward and back to make sure the seat is securely held in place. To check this, grab the seat at the belt path and attempt to move it side to side and forward. There should be no more than one inch of movement for proper installation.

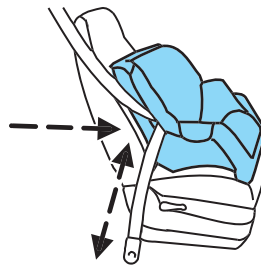

10. Try to pull the belt out of the retractor to make sure the retractor is in the automatic locking mode (you should not be able to pull more belt out). If the retractor is not locked, unbuckle the belt and repeat Steps two through nine.

Check to make sure the child seat is properly secured before each use.

### Attaching child safety seats with tether straps

Most new forward-facing child safety seats include a tether strap which goes over the back of the seat and hooks to an anchoring point. Tether straps are available as an accessory for many older safety seats. Contact the manufacturer of your child seat for information about ordering a tether strap.



Children should be placed in the rear in an appropriate child safety seat that is properly secured to the vehicle.

## Seating and Safety Restraints

The tether anchors in your vehicle are in the positions shown:

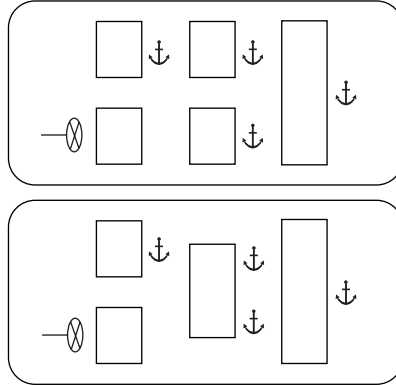

**The front passenger seat with power adjustment does not have a tether anchor.** The two tether anchors on the back of the second row bench seat can be used either for child safety seats at the two seating positions, or either anchor can be used for a single LATCH child seat installed at the center of the bench seat.

### ***Front passenger seating position (manual adjusting seats only)***

1. Position the child safety seat on the passenger seat cushion.

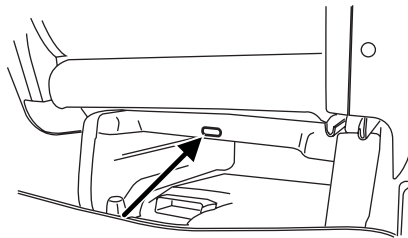



## Seating and Safety Restraints

2. Route the child safety seat tether strap over the back of the seat. If the head restraint is adjustable, route the tether strap under the head restraint and between the head restraint posts. If the top of the safety seat hits the head restraint, raise the head restraint to let the child seat fit further rearward.

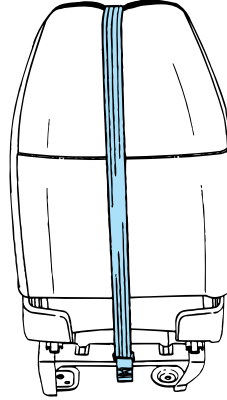

3. Grasp the tether strap and position it to the seat frame.

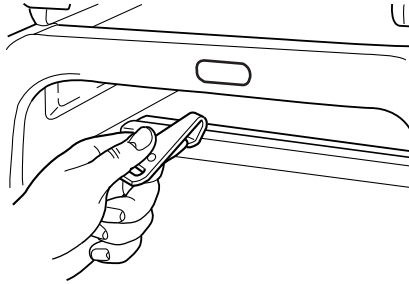

4. Rotate the tether hook, and clip the tether strap to the seat frame.

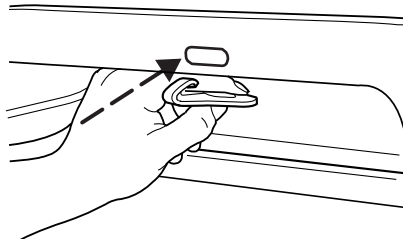

## Seating and Safety Restraints



If the tether strap is clipped incorrectly (as shown) the child safety seat may not be retained properly in the event of a collision.

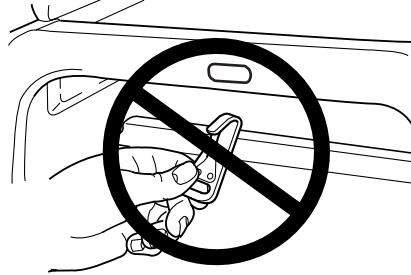

5. Rotate the tether strap clip.

6. Install the child safety seat tightly using the LATCH anchors or safety belts. Follow the instructions in this chapter.

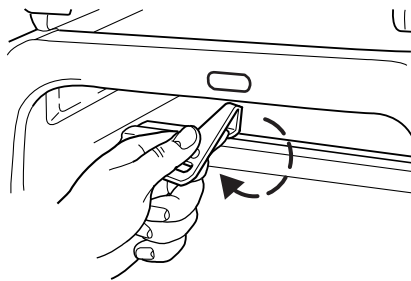

7. Tighten the child safety seat tether strap according to the manufacturer's instructions.

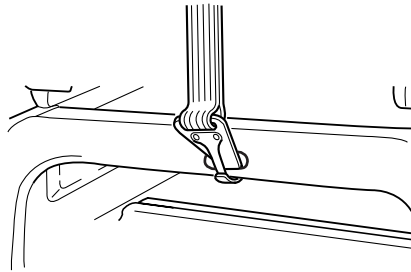

## Seating and Safety Restraints

### **Rear seating positions**

Follow Steps 1–7 as described above for the following available seats:

- 2nd row bucket

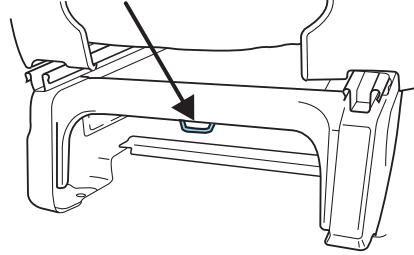

- 2nd row bench

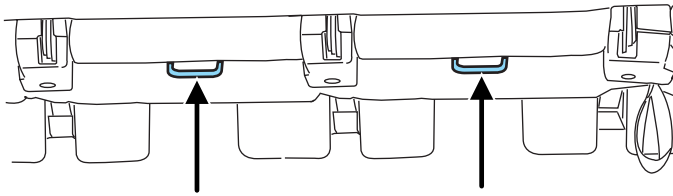

- 3rd row bench

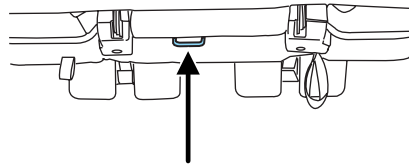

For additional important safety information on the proper use of safety belts, child seats and infant seats, please read the entire *Seating and safety restraints* chapter in this owner's guide.

### **Attaching safety seats with LATCH (Lower Anchors and Tethers for Children) attachments for child seat anchors**

New child safety seats have two rigid or webbing mounted attachments that connect to two anchors at certain seating positions in your vehicle. This type of child seat eliminates the need to use safety belts to attach the child seat. For forward-facing child seats, the tether strap must also be attached to the proper tether anchor. See *Attaching safety seats with tether straps* in this chapter.

## Seating and Safety Restraints

Your vehicle has LATCH anchors for child seat installation at the seating positions marked with the child seat symbol.

**If your vehicle has a second row bench seat, one child seat can be placed in each outboard seating position, or one LATCH child seat can be placed in the center of the seat only.** Please note that the center-only position does not have a separate tether anchor. Either of the outboard tether anchors may be used for the center position.

Do not use the two designated seating positions of the 2nd row bench when a LATCH child seat is installed at the center. A child seat will block access to the safety belt buckles.

 Never attach two LATCH child safety seats to the same anchor. In a crash, one anchor may not be strong enough to hold two child safety seat attachments and may break, causing serious injury or death.

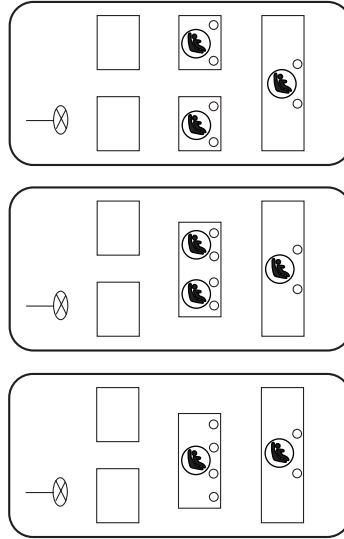

The lower anchors for child seat installation are located at the rear section of the rear seat between the cushion and seat back.

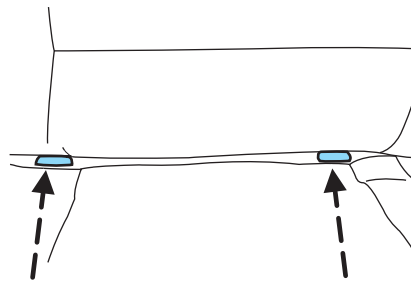

## Seating and Safety Restraints

Follow the child seat manufacturer's instructions to properly install a child seat with LATCH attachments.



Attach LATCH lower attachments of the child seat only to the anchors shown.

If you install a child seat with rigid LATCH attachments, do not tighten the tether strap enough to lift the child seat off the vehicle seat cushion when the child is seated in it. Keep the tether strap just snug without lifting the front of the child seat. Keeping the child seat just touching the vehicle seat gives the best protection in a severe crash. Adjusting the seat back angle may allow the tether strap to be tight without lifting the child seat.

Each time you use the safety seat, check that the seat is properly attached to the lower anchors and tether anchor. Try to tilt the child seat from side to side. Also try to tug the seat forward. Check to see if the anchors hold the seat in place.



If the safety seat is not anchored properly, the risk of a child being injured in a crash greatly increases.

## Tires, Wheels and Loading

### INFORMATION ABOUT UNIFORM TIRE QUALITY GRADING

New vehicles are fitted with tires that have a rating on them called Tire Quality Grades. The Quality grades can be found where applicable on the tire sidewall between tread shoulder and maximum section width. For example:

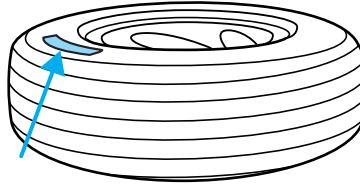

- **Treadwear 200 Traction AA Temperature A**

These Tire Quality Grades are determined by standards that the United States Department of Transportation has set.

Tire Quality Grades apply to new pneumatic tires for use on passenger cars. They do not apply to deep tread, winter-type snow tires, space-saver or temporary use spare tires, tires with nominal rim diameters of 10 to 12 inches or limited production tires as defined in Title 49 Code of Federal Regulations Part 575.104(c)(2).

**U.S. Department of Transportation-Tire quality grades:** The U.S. Department of Transportation requires Ford Motor Company to give you the following information about tire grades exactly as the government has written it.

#### **Treadwear**

The treadwear grade is a comparative rating based on the wear rate of the tire when tested under controlled conditions on a specified government test course. For example, a tire graded 150 would wear one and one-half (1 1/2) times as well on the government course as a tire graded 100. The relative performance of tires depends upon the actual conditions of their use, however, and may depart significantly from the norm due to variations in driving habits, service practices, and differences in road characteristics and climate.

#### **Traction AA A B C**

The traction grades, from highest to lowest are AA, A, B, and C. The grades represent the tire's ability to stop on wet pavement as measured under controlled conditions on specified government test surfaces of asphalt and concrete. A tire marked C may have poor traction performance.

182

## Tires, Wheels and Loading



The traction grade assigned to this tire is based on straight-ahead braking traction tests, and does not include acceleration, cornering, hydroplaning or peak traction characteristics.

### Temperature A B C

The temperature grades are A (the highest), B and C, representing the tire's resistance to the generation of heat and its ability to dissipate heat when tested under controlled conditions on a specified indoor laboratory test wheel. Sustained high temperature can cause the material of the tire to degenerate and reduce tire life, and excessive temperature can lead to sudden tire failure. The grade C corresponds to a level of performance which all passenger car tires must meet under the Federal Motor Vehicle Safety Standard No. 109. Grades B and A represent higher levels of performance on the laboratory test wheel than the minimum required by law.



The temperature grade for this tire is established for a tire that is properly inflated and not overloaded. Excessive speed, underinflation, or excessive loading, either separately or in combination, can cause heat buildup and possible tire failure.

### TIRES

Tires are designed to give many thousands of miles of service, but they must be maintained in order to get the maximum benefit from them.

#### Glossary of tire terminology

- **Tire label:** A label showing the OE (Original Equipment) tire sizes, recommended inflation pressure and the maximum weight the vehicle can carry.
- **Tire Identification Number (TIN):** A number on the sidewall of each tire providing information about the tire brand and manufacturing plant, tire size and date of manufacture. Also referred to as DOT code.
- **Inflation pressure:** A measure of the amount of air in a tire.
- **Standard load:** A class of P-metric or Metric tires designed to carry a maximum load at 35 psi [37 psi (2.5 bar) for Metric tires]. Increasing the inflation pressure beyond this pressure will not increase the tire's load carrying capability.
- **Extra load:** A class of P-metric or Metric tires designed to carry a heavier maximum load at 41 psi [43 psi (2.9 bar) for Metric tires].

## Tires, Wheels and Loading

Increasing the inflation pressure beyond this pressure will not increase the tire's load carrying capability.

- **kPa:** Kilopascal, a metric unit of air pressure.
- **PSI:** Pounds per square inch, a standard unit of air pressure.
- **Cold inflation pressure:** The tire pressure when the vehicle has been stationary and out of direct sunlight for an hour or more and prior to the vehicle being driven for 1 mile (1.6 km).
- **Recommended inflation pressure:** The cold inflation pressure found on the Safety Compliance Certification Label or Tire Label located on the B-Pillar or the edge of the driver's door.
- **B-pillar:** The structural member at the side of the vehicle behind the front door.
- **Bead area of the tire:** Area of the tire next to the rim.
- **Sidewall of the tire:** Area between the bead area and the tread.
- **Tread area of the tire:** Area of the perimeter of the tire that contacts the road when mounted on the vehicle.
- **Rim:** The metal support (wheel) for a tire or a tire and tube assembly upon which the tire beads are seated.

### INFLATING YOUR TIRES

Safe operation of your vehicle requires that your tires are properly inflated. Remember that a tire can lose up to half of its air pressure without appearing flat.

Every day before you drive, check your tires. If one looks lower than the others, use a tire gauge to check pressure of all tires and adjust if required.

At least once a month and before long trips, inspect each tire and check the tire pressure with a tire gauge (including spare, if equipped). Inflate all tires to the inflation pressure recommended by Ford Motor Company.

Use a tire gauge to check the tire inflation pressure, including the spare (if equipped), at least monthly and before long trips. You are strongly urged to buy a reliable tire pressure gauge, as automatic service station gauges may be inaccurate. Ford Motor Company recommends the use of a digital or dial-type tire pressure gauge rather than a stick-type tire pressure gauge.

Use the recommended cold inflation pressure for optimum tire performance and wear. Under-inflation or over-inflation may cause uneven treadwear patterns.



## Tires, Wheels and Loading



Under-inflation is the most common cause of tire failures and may result in severe tire cracking, tread separation or "blowout", with unexpected loss of vehicle control and increased risk of injury. Under-inflation increases sidewall flexing and rolling resistance, resulting in heat buildup and internal damage to the tire. It also may result in unnecessary tire stress, irregular wear, loss of vehicle control and accidents. A tire can lose up to half of its air pressure and not appear to be flat!

Always inflate your tires to the Ford recommended inflation pressure even if it is less than the maximum inflation pressure information found on the tire. The Ford recommended tire inflation pressure is found on the Safety Compliance Certification Label or Tire Label which is located on the B-Pillar or the edge of the driver's door. Failure to follow the tire pressure recommendations can cause uneven treadwear patterns and adversely affect the way your vehicle handles.

**Maximum Permissible Inflation Pressure** is the tire manufacturer's maximum permissible pressure and/or the pressure at which the maximum load can be carried by the tire. This pressure is normally higher than the manufacturer's recommended cold inflation pressure which can be found on the Safety Compliance Certification Label or Tire Label which is located on the B-Pillar or the edge of the driver's door. The cold inflation pressure should never be set lower than the recommended pressure on the Safety Compliance Certification Label or Tire Label.

When weather temperature changes occur, tire inflation pressures also change. A 10° F (6° C) temperature drop can cause a corresponding drop of 1 psi (7 kPa) in inflation pressure. Check your tire pressures frequently and adjust them to the proper pressure which can be found on the Safety Compliance Certification Label or Tire Label.

To check the pressure in your tire(s):

1. Make sure the tires are cool, meaning they are not hot from driving even a mile.

If you are checking tire pressure when the tire is hot, (i.e. driven more than 1 mile [1.6 km]), never "bleed" or reduce air pressure. The tires are hot from driving and it is normal for pressures to increase above recommended cold pressures. A hot tire at or below recommended cold inflation pressure could be significantly under-inflated.

**Note:** If you have to drive a distance to get air for your tire(s), check and record the tire pressure first and add the appropriate air pressure

## Tires, Wheels and Loading

when you get to the pump. It is normal for tires to heat up and the air pressure inside to go up as you drive.

2. Remove the cap from the valve on one tire, then firmly press the tire gauge onto the valve and measure the pressure with the tire gauge.

3. Add enough air to reach the recommended air pressure.

**Note:** If you overfill the tire, release air by pushing on the metal stem in the center of the valve. Then recheck the pressure with your tire gauge.

4. Replace the valve cap.

5. Repeat this procedure for each tire, including the spare.

**Note:** Some spare tires operate at a higher inflation pressure than the other tires. For T-type/mini-spare tires (see *T-Type/Mini-Spare Tire Information* section for description): Store and maintain at 60psi (4.15 bars). For Full Size and Dissimilar spare tires (see *Dissimilar Spare Tire/Wheel Information* section for description): Store and maintain at the higher of the front and rear inflation pressure as shown on the Safety Compliance Certification Label or the Tire Label.

6. Visually inspect the tires to make sure there are no nails or other objects embedded that could poke a hole in the tire and cause an air leak.

7. Check the sidewalls to make sure there are no gouges, cuts or bulges.

### TIRE CARE

#### Inspecting your tires

Periodically inspect the tire treads for uneven or excessive wear and remove objects such as stones, nails or glass that may be wedged in the tread grooves. Check for holes or cuts that may permit air leakage from the tire and make necessary repairs. Also inspect the tire sidewalls for cracking, cuts, bruises and other signs of damage or excessive wear. If internal damage to the tire is suspected, have the tire demounted and inspected in case it needs to be repaired or replaced. For your safety, tires that are damaged or show signs of excessive wear should not be used because they are more likely to blow out or fail.

Improper or inadequate vehicle maintenance can cause tires to wear abnormally. Inspect all your tires, including the spare, frequently, and replace them if one or more of the following conditions exist:

## Tires, Wheels and Loading

### Tire wear

When the tread is worn down to 1/16th of an inch (2 mm), tires must be replaced to help prevent your vehicle from skidding and hydroplaning. Built-in treadwear indicators, or “wear bars”, which look like narrow strips of smooth rubber across the tread will appear on the tire when the tread is worn down to 1/16th of an inch (2 mm).

When the tire tread wears down to the same height as these “wear bars”, the tire is worn out and must be replaced.

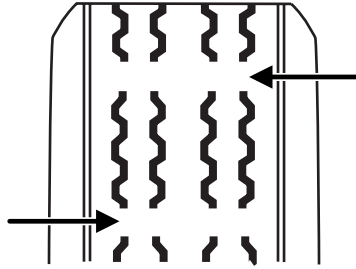

### Damage

Periodically inspect the tire treads and sidewalls for damage (such as bulges in the tread or sidewalls, cracks in the tread groove and separation in the tread or sidewall). If damage is observed or suspected have the tire inspected by a tire professional. Tires can be damaged during off-road use, so inspection after off-road use is also recommended.



### Age

Tires degrade over time, even when they are not being used. It is recommended that tires generally be replaced after 6 years of normal service. Heat caused by hot climates or frequent high loading conditions can accelerate the aging process.

You should replace the spare tire when you replace the other road tires due to the aging of the spare tire.

### U.S. DOT Tire Identification Number (TIN)

Both U.S. and Canada Federal regulations require tire manufacturers to place standardized information on the sidewall of all tires. This information identifies and describes the fundamental characteristics of the tire and also provides a U.S. DOT Tire Identification Number for safety standard certification and in case of a recall.

This begins with the letters “DOT” and indicates that the tire meets all federal standards. The next two numbers or letters are the plant code designating where it was manufactured, the next two are the tire size code and the last four numbers represent the week and year the tire was

## Tires, Wheels and Loading

built. For example, the numbers 317 mean the 31st week of 1997. After 2000 the numbers go to four digits. For example, 2501 means the 25th week of 2001. The numbers in between are identification codes used for traceability. This information is used to contact customers if a tire defect requires a recall.

### Tire Replacement Requirements

Your vehicle is equipped with tires designed to provide a safe ride and handling capability.



Only use replacement tires and wheels that are the same size and type (such as P-metric versus LT-metric or all-season versus all-terrain) as those originally provided by Ford. Use of any tire or wheel not recommended by Ford can affect the safety and performance of your vehicle, which could result in an increased risk of loss of vehicle control, vehicle rollover, personal injury and death. Additionally the use of non-recommended tires and wheels could cause steering, suspension, axle or transfer case/power transfer unit failure. If you have questions regarding tire replacement, see an authorized dealer.



When mounting replacement tires and wheels, you should not exceed the maximum pressure indicated on the sidewall of the tire to set the beads without additional precautions listed below. If the beads do not seat at the maximum pressure indicated, re-lubricate and try again.

If a pressure in excess of the maximum pressure indicated is required, the following additional precautions must be taken to protect the person mounting the tire:

First check to ensure that you have the correct tire and wheel size.

For mounting pressures up to 20 psi greater than the maximum pressure on the tire sidewall: When inflating the tire:

1. First, again lubricate the tire bead and wheel bead seat area
2. Stand at a minimum of 12 feet away from the tire wheel assembly
3. Use both eye and ear protection

For a mounting pressure more than 20 psi greater than the maximum pressure, a Ford Dealer or other tire service professional should do the mounting.

Always inflate steel carcass tires with a remote air fill with the person inflating standing at a minimum of 12 ft. away from the tire wheel assembly.

## Tires, Wheels and Loading

**Important:** Remember to replace the wheel valve stems when the road tires are replaced on your vehicle.

It is recommended that the two front tires or two rear tires generally be replaced as a pair.

The tire pressure sensors mounted in the wheels (originally installed on your vehicle) are not designed to be used in aftermarket wheels.

The use of wheels or tires not recommended by Ford Motor Company may affect the operation of your Tire Pressure Monitoring System.

If the TPMS indicator is flashing, your TPMS is malfunctioning. Your replacement tire might be incompatible with your TPMS, or some component of the TPMS may be damaged.

### Safety practices

Driving habits have a great deal to do with your tire mileage and safety.

- Observe posted speed limits
- Avoid fast starts, stops and turns
- Avoid potholes and objects on the road
- Do not run over curbs or hit the tire against a curb when parking



If your vehicle is stuck in snow, mud, sand, etc., **do not** rapidly spin the tires; spinning the tires can tear the tire and cause an explosion. A tire can explode in as little as three to five seconds.



Do not spin the wheels at over 35 mph (56 km/h). The tires may fail and injure a passenger or bystander.

### Highway hazards

No matter how carefully you drive there's always the possibility that you may eventually have a flat tire on the highway. Drive slowly to the closest safe area out of traffic. This may further damage the flat tire, but your safety is more important.

If you feel a sudden vibration or ride disturbance while driving, or you suspect your tire or vehicle has been damaged, immediately reduce your speed. Drive with caution until you can safely pull off the road. Stop and inspect the tires for damage. If a tire is under-inflated or damaged, deflate it, remove wheel and replace it with your spare tire and wheel. If you cannot detect a cause, have the vehicle towed to the nearest repair facility or tire dealer to have the vehicle inspected.

## Tires, Wheels and Loading

### Tire and wheel alignment

A bad jolt from hitting a curb or pothole can cause the front end of your vehicle to become misaligned or cause damage to your tires. If your vehicle seems to pull to one side when you're driving, the wheels may be out of alignment. Have an authorized dealer check the wheel alignment periodically.

Wheel misalignment in the front or the rear can cause uneven and rapid treadwear of your tires and should be corrected by an authorized dealer. Front wheel drive (FWD) vehicles and those with an independent rear suspension (if equipped) may require alignment of all four wheels.

The tires should also be balanced periodically. An unbalanced tire and wheel assembly may result in irregular tire wear.

### Tire rotation

Rotating your tires at the recommended interval (as indicated in the *scheduled maintenance information* that comes with your vehicle) will help your tires wear more evenly, providing better tire performance and longer tire life. Unless otherwise specified, rotate the tires approximately every 5,000 miles (8,000 km).

- Front Wheel Drive (FWD) vehicles (front tires at top of diagram)

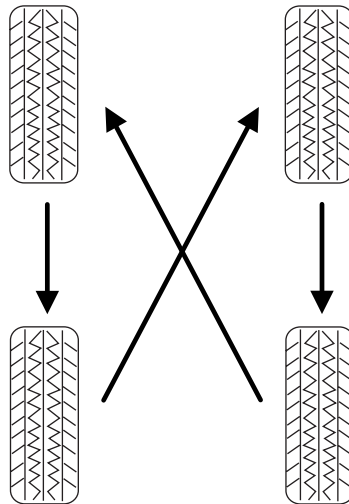

Sometimes irregular tire wear can be corrected by rotating the tires.

## Tires, Wheels and Loading

**Note:** If your tires show uneven wear ask an authorized dealer to check for and correct any wheel misalignment, tire imbalance or mechanical problem involved before tire rotation.

**Note:** Your vehicle may be equipped with a dissimilar spare tire/wheel. A dissimilar spare tire/wheel is defined as a spare tire and/or wheel that is different in brand, size or appearance from the road tires and wheels. If you have a dissimilar spare tire/wheel it is intended for temporary use only and should not be used in a tire rotation.

**Note:** After having your tires rotated, inflation pressure must be checked and adjusted to the vehicle requirements.

### INFORMATION CONTAINED ON THE TIRE SIDEWALL

Both U.S. and Canada Federal regulations require tire manufacturers to place standardized information on the sidewall of all tires. This information identifies and describes the fundamental characteristics of the tire and also provides a U.S. DOT Tire Identification Number for safety standard certification and in case of a recall.

#### Information on “P” type tires

P215/65R15 95H is an example of a tire size, load index and speed rating. The definitions of these items are listed below. (Note that the tire size, load index and speed rating for your vehicle may be different from this example.)

1. **P:** Indicates a tire, designated by the Tire and Rim Association (T&RA), that may be used for service on cars, SUVs, minivans and light trucks.

**Note:** If your tire size does not begin with a letter this may mean it is designated by either ETRTO (European Tire and Rim Technical Organization) or JATMA (Japan Tire Manufacturing Association).

2. **215:** Indicates the nominal width of the tire in millimeters from sidewall edge to sidewall edge. In general, the larger the number, the wider the tire.

3. **65:** Indicates the aspect ratio which gives the tire’s ratio of height to width.

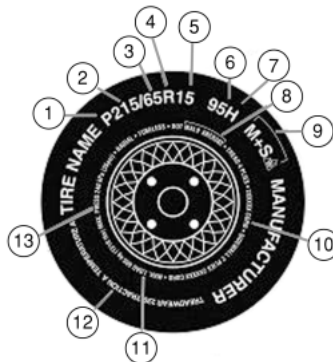

## Tires, Wheels and Loading

4. **R:** Indicates a “radial” type tire.

5. **15:** Indicates the wheel or rim diameter in inches. If you change your wheel size, you will have to purchase new tires to match the new wheel diameter.

6. **95:** Indicates the tire’s load index. It is an index that relates to how much weight a tire can carry. You may find this information in your *Owner’s Guide*. If not, contact a local tire dealer.

**Note:** You may not find this information on all tires because it is not required by federal law.

7. **H:** Indicates the tire’s speed rating. The speed rating denotes the speed at which a tire is designed to be driven for extended periods of time under a standard condition of load and inflation pressure. The tires on your vehicle may operate at different conditions for load and inflation pressure. These speed ratings may need to be adjusted for the difference in conditions. The ratings range from 81 mph (130 km/h) to 186 mph (299 km/h). These ratings are listed in the following chart.

**Note:** You may not find this information on all tires because it is not required by federal law.

Letter rating	Speed rating - mph (km/h)
M	81 mph (130 km/h)
N	87 mph (140 km/h)
Q	99 mph (159 km/h)
R	106 mph (171 km/h)
S	112 mph (180 km/h)
T	118 mph (190 km/h)
U	124 mph (200 km/h)
H	130 mph (210 km/h)
V	149 mph (240 km/h)
W	168 mph (270 km/h)
Y	186 mph (299 km/h)

**Note:** For tires with a maximum speed capability over 149 mph (240 km/h), tire manufacturers sometimes use the letters ZR. For those with a maximum speed capability over 186 mph (299 km/h), tire manufacturers always use the letters ZR.

8. **U.S. DOT Tire Identification Number (TIN):** This begins with the letters “DOT” and indicates that the tire meets all federal standards. The



## Tires, Wheels and Loading

next two numbers or letters are the plant code designating where it was manufactured, the next two are the tire size code and the last four numbers represent the week and year the tire was built. For example, the numbers 317 mean the 31st week of 1997. After 2000 the numbers go to four digits. For example, 2501 means the 25th week of 2001. The numbers in between are identification codes used for traceability. This information is used to contact customers if a tire defect requires a recall.

9. **M+S or M/S:** Mud and Snow, or

**AT:** All Terrain, or

**AS:** All Season.

10. **Tire Ply Composition and Material Used:** Indicates the number of plies or the number of layers of rubber-coated fabric in the tire tread and sidewall. Tire manufacturers also must indicate the ply materials in the tire and the sidewall, which include steel, nylon, polyester, and others.

11. **Maximum Load:** Indicates the maximum load in kilograms and pounds that can be carried by the tire. Refer to the Safety Compliance Certification Label, which is located on the B-Pillar or the edge of the driver's door, for the correct tire pressure for your vehicle.

### 12. Treadwear, Traction and Temperature Grades

- **Treadwear:** The treadwear grade is a comparative rating based on the wear rate of the tire when tested under controlled conditions on a specified government test course. For example, a tire graded 150 would wear one and one-half (1½) times as well on the government course as a tire graded 100.
- **Traction:** The traction grades, from highest to lowest are AA, A, B, and C. The grades represent the tire's ability to stop on wet pavement as measured under controlled conditions on specified government test surfaces of asphalt and concrete. A tire marked C may have poor traction performance.
- **Temperature:** The temperature grades are A (the highest), B and C, representing the tire's resistance to the generation of heat and its ability to dissipate heat when tested under controlled conditions on a specified indoor laboratory test wheel.

13. **Maximum Permissible Inflation Pressure:** Indicates the tire manufacturers' maximum permissible pressure and/or the pressure at which the maximum load can be carried by the tire. This pressure is normally higher than the manufacturer's recommended cold inflation pressure which can be found on the Safety Compliance Certification Label or Tire Label which is located on the B-Pillar or the edge of the driver's door. The cold inflation pressure should never be set lower than the recommended pressure on the vehicle label.

## Tires, Wheels and Loading

The tire suppliers may have additional markings, notes or warnings such as standard load, radial tubeless, etc.

### Additional information contained on the tire sidewall for “LT” type tires

“LT” type tires have some additional information beyond those of “P” type tires; these differences are described below:

1. **LT:** Indicates a tire, designated by the Tire and Rim Association (T&RA), that is intended for service on light trucks.

#### 2. Load Range/Load Inflation

**Limits:** Indicates the tire’s load-carrying capabilities and its inflation limits.

#### 3. Maximum Load Dual lb. (kg)

**at psi (kPa) cold:** Indicates the maximum load and tire pressure when the tire is used as a dual; defined as four tires on the rear axle (a total of six or more tires on the vehicle).

4. **Maximum Load Single lb. (kg) at psi (kPa) cold:** Indicates the maximum load and tire pressure when the tire is used as a single; defined as two tires (total) on the rear axle.

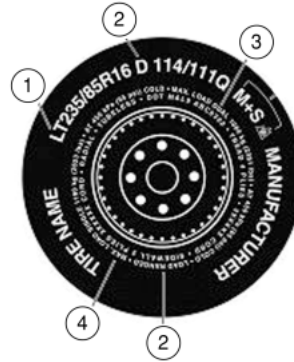

## Tires, Wheels and Loading

### Information on “T” type tires

“T” type tires have some additional information beyond those of “P” type tires; these differences are described below:

T145/80D16 is an example of a tire size.

**Note:** The temporary tire size for your vehicle may be different from this example.

1. **T:** Indicates a type of tire, designated by the Tire and Rim Association (T&RA), that is intended for temporary service on cars, SUVs, minivans and light trucks.

2. **145:** Indicates the nominal width of the tire in millimeters from sidewall edge to sidewall edge. In general, the larger the number, the wider the tire.

3. **80:** Indicates the aspect ratio which gives the tire’s ratio of height to width. Numbers of 70 or lower indicate a short sidewall.

4. **D:** Indicates a “diagonal” type tire.

**R:** Indicates a “radial” type tire.

5. **16:** Indicates the wheel or rim diameter in inches. If you change your wheel size, you will have to purchase new tires to match the new wheel diameter.

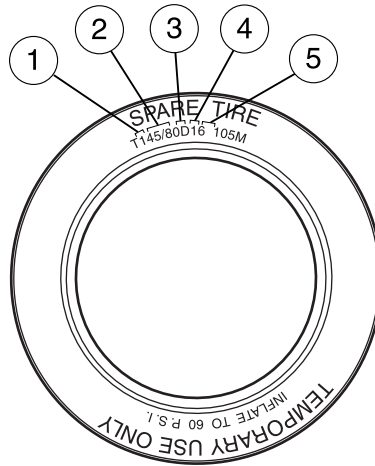

### Location of the tire label

You will find a Tire Label containing tire inflation pressure by tire size and other important information located on the B-Pillar or the edge of the driver’s door. Refer to the payload description and graphic in the *Vehicle loading — with and without a trailer* section.

## Tires, Wheels and Loading

### TIRE PRESSURE MONITORING SYSTEM (TPMS)

Each tire, including the spare (if provided), should be checked monthly when cold and inflated to the inflation pressure recommended by the vehicle manufacturer on the

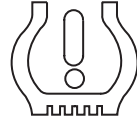

vehicle placard or tire inflation pressure label. (If your vehicle has tires of a different size than the size indicated on the vehicle placard or tire inflation pressure label, you should determine the proper tire inflation pressure for those tires.)

As an added safety feature, your vehicle has been equipped with a tire pressure monitoring system (TPMS) that illuminates a low tire pressure telltale when one or more of your tires is significantly under-inflated. Accordingly, when the low tire pressure telltale illuminates, you should stop and check your tires as soon as possible, and inflate them to the proper pressure. Driving on a significantly under-inflated tire causes the tire to overheat and can lead to tire failure. Under-inflation also reduces fuel efficiency and tire tread life, and may affect the vehicle's handling and stopping ability.

Please note that the TPMS is not a substitute for proper tire maintenance, and it is the driver's responsibility to maintain correct tire pressure, even if under-inflation has not reached the level to trigger illumination of the TPMS low tire pressure telltale.

The Tire Pressure Monitoring System complies with part 15 of the FCC rules and with RSS-210 of Industry Canada. Operation is subject to the following two conditions: (1) This device may not cause harmful interference, and (2) This device must accept any interference received, including interference that may cause undesired operation.



The Tire Pressure Monitoring System is NOT a substitute for manually checking tire pressure. The tire pressure should be checked periodically (at least monthly) using a tire gauge, see *Inflating your tires* in this chapter. Failure to properly maintain your tire pressure could increase the risk of tire failure, loss of control, vehicle rollover and personal injury.

## Tires, Wheels and Loading

### Changing tires with TPMS

**Each road tire is equipped with a tire pressure sensor fastened to the inside rim of the wheel. The pressure sensor is covered by the tire and is not visible unless the tire is removed. The pressure sensor is located opposite (180 degrees) from the valve stem. Care must be taken when changing the tire to avoid damaging the sensor.** It is recommended that you always have your tires serviced by an authorized dealer.

The tire pressure should be checked periodically (at least monthly) using an accurate tire gauge, refer to *Inflating your tires* in this chapter.

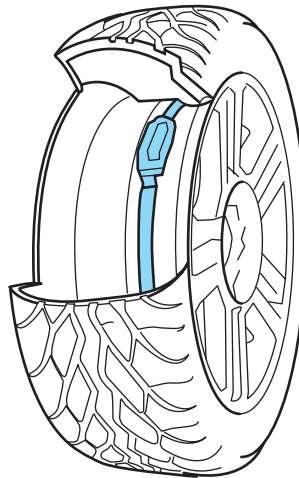

### Understanding your Tire Pressure Monitoring System (TPMS)

The Tire Pressure Monitoring System measures pressure in your four road tires and sends the tire pressure readings to your vehicle. The Low Tire Warning Lamp will turn ON if the tire pressure is significantly low. Once the light is illuminated, your tires are under inflated and need to be inflated to the manufacturer's recommended tire pressure. Even if the light turns ON and a short time later turns OFF, your tire pressure still needs to be checked.

### ***When your temporary spare tire is installed***

When one of your road tires needs to be replaced with the temporary spare, the TPMS system will continue to identify an issue to remind you that the damaged road wheel/tire needs to be repaired and put back on your vehicle.

To restore the full functionality of the Tire Pressure Monitoring System, have the damaged road wheel/tire repaired and remounted on your vehicle. For additional information, refer to *Changing tires with TPMS* in this section.

## Tires, Wheels and Loading

### ***When you believe your system is not operating properly***

The main function of the Tire Pressure Monitoring System is to warn you when your tires need air. It can also warn you in the event the system is no longer capable of functioning as intended. Please refer to the following chart for information concerning your Tire Pressure Monitoring System:

<b>Low Tire Pressure Warning Light</b>	<b>Possible cause</b>	<b>Customer Action Required</b>
Solid Warning Light	Tire(s) under-inflated	1. Check your tire pressure to ensure tires are properly inflated; refer to <i>Inflating your tires</i> in this chapter. 2. After inflating your tires to the manufacturer's recommended inflation pressure as shown on the Tire Label (located on the edge of driver's door or the B-Pillar), the vehicle must be driven for at least two minutes over 20 mph (32 km/h) before the light will turn OFF.
	Spare tire in use	Your temporary spare tire is in use. Repair the damaged road wheel/tire and reinstall it on the vehicle to restore system functionality. For a description on how the system functions, refer to <i>When your temporary spare tire is installed</i> in this section.
	TPMS malfunction	If your tires are properly inflated and your spare tire is not in use and the light remains ON, have the system inspected by your authorized dealer.

## Tires, Wheels and Loading

Low Tire Pressure Warning Light	Possible cause	Customer Action Required
Flashing Warning Light	Spare tire in use	Your temporary spare tire is in use. Repair the damaged road wheel and re-mount it on the vehicle to restore system functionality. For a description of how the system functions under these conditions, refer to <i>When your temporary spare tire is installed</i> in this section.
	TPMS malfunction	If your tires are properly inflated and your spare tire is not in use and the TPMS warning light is still ON, have the system inspected by your authorized dealer.

### ***When inflating your tires***

When putting air into your tires (such as at a gas station or in your garage), the Tire Pressure Monitoring System may not respond immediately to the air added to your tires.

It may take up to two minutes of driving over 20 mph (32 km/h) for the light to turn OFF after you have filled your tires to the recommended inflation pressure.

### ***How temperature affects your tire pressure***

The Tire Pressure Monitoring System (TPMS) monitors tire pressure in each pneumatic tire. While driving in a normal manner, a typical passenger tire inflation pressure may increase approximately 2 to 4 psi (14 to 28 kPa) from a cold start situation. If the vehicle is stationary over night with the outside temperature significantly lower than the daytime temperature, the tire pressure may decrease approximately 3 psi (20.7 kPa) for a drop of 30° F (16.6° C) in ambient temperature. This lower pressure value may be detected by the TPMS as being significantly lower than the recommended inflation pressure and activate the TPMS warning for low tire pressure. If the low tire pressure warning light is ON, visually check each tire to verify that no tire is flat. If one or more tires are flat, repair as necessary. Check air pressure in the road tires. If any tire is under-inflated, carefully drive the vehicle to the nearest location where air can be added to the tires. Inflate all the tires to the recommended inflation pressure.

## Tires, Wheels and Loading

### SNOW TIRES AND CHAINS



Snow tires must be the same size and grade as the tires you currently have on your vehicle.

The tires on your vehicle have all weather treads to provide traction in rain and snow. However, in some climates, you may need to use snow tires and chains. If you need to use chains, it is recommended that steel wheels (of the same size and specifications) be used as chains may chip aluminum wheels.

Follow these guidelines when using snow tires and chains:

- Use only cable type SAE Class “S” chains. Conventional link or other type chains may cause damage to your vehicle’s wheelhouse and/or underbody.
- These cable type chains should only be applied to the front wheels.
- Install chains securely, verifying that the chains do not touch any wiring, brake lines or fuel lines.
- Drive cautiously. If you hear the chains rub or bang against your vehicle, stop and re-tighten the chains. If this does not work, remove the chains to prevent damage to your vehicle.
- If possible, avoid fully loading your vehicle.
- Remove the tire chains when they are no longer needed. Do not use tire chains on dry roads.
- The suspension insulation and bumpers will help prevent vehicle damage. Do not remove these components from your vehicle when using snow tires and chains.

### VEHICLE LOADING – WITH AND WITHOUT A TRAILER

This section will guide you in the proper loading of your vehicle and/or trailer, to keep your loaded vehicle weight within its design rating capability, with or without a trailer. Properly loading your vehicle will provide maximum return of vehicle design performance. Before loading your vehicle, familiarize yourself with the following terms for determining your vehicle’s weight ratings, with or without a trailer, from the vehicle’s Tire Label or Safety Compliance Certification Label:

**Base Curb Weight** – is the weight of the vehicle including a full tank of fuel and all standard equipment. It does not include passengers, cargo, or optional equipment.

**Vehicle Curb Weight** – is the weight of your new vehicle when you picked it up from your authorized dealer plus any aftermarket equipment.

200



## Tires, Wheels and Loading

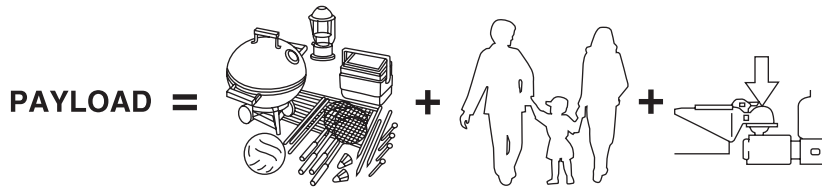

**Payload** – is the combined weight of cargo and passengers that the vehicle is carrying. The maximum payload for your vehicle can be found on the Tire Label on the B-Pillar or the edge of the driver's door (vehicles exported outside the US and Canada may not have a Tire Label). Look for **“THE COMBINED WEIGHT OF OCCUPANTS AND CARGO SHOULD NEVER EXCEED XXX kg OR XXX lb.”** for maximum payload. The payload listed on the Tire Label is the maximum payload for the vehicle as built by the assembly plant. If any aftermarket or authorized-dealer installed equipment has been installed on the vehicle, the weight of the equipment must be subtracted from the payload listed on the Tire Label in order to determine the new payload.

 The appropriate loading capacity of your vehicle can be limited either by volume capacity (how much space is available) or by payload capacity (how much weight the vehicle should carry). Once you have reached the maximum payload of your vehicle, do not add more cargo, even if there is space available. Overloading or improperly loading your vehicle can contribute to loss of vehicle control and vehicle rollover.

## Tires, Wheels and Loading

Example only:

TIRE AND LOADING INFORMATION				
SEATING CAPACITY		TOTAL 5	FRONT 2	REAR 3
The combined weight of occupants and cargo should never exceed : <b>XXX kg or XXX lbs.</b>				
TIRE	SIZE	COLD TIRE PRESSURE	SEE OWNERS MANUAL FOR ADDITIONAL INFORMATION	
FRONT	LT225/75R 16.5E	200 KPA, 29 PSI		
REAR	LT225/75R 16.5E	200 KPA, 29 PSI		
SPARE	T145/80D16 P225/60R17	420 KPA, 60 PSI 200 KPA, 29 PSI		

TIRE AND LOAD INFORMATION				
RENSEIGNEMENTS RELATIFS AUX PNEUS ET À LA CHARGE				
SEATING CAPACITY		TOTAL XX	FRONT XX	REAR X
NOMBRE DE PLACES		TOTAL XX	AVANT XX	ARRIERE X
The combined weight of occupants and cargo should never exceed : <b>XXX kg.</b> La charge du véhicule (occupants et bagages) ne doit jamais dépasser : <b>XXX lbs.</b>				
TIRE PNEUS	SIZE DIMENSIONS	COLD TIRE PRESSURE PRESSION À FROID	SEE OWNERS MANUAL FOR ADDITIONAL INFORMATION CONSULTER LE GUIDE DU PROPRIÉTAIRE POUR DE PLUS AMPLES RESEIGNEMENTS	
FRONT/ AVANT	LT225/75R 16.5E	200 KPA, 29 PSI		
REAR/ ARRIERE	LT225/75R 16.5E	200 KPA, 29 PSI		
SPARE/ PNEU DE SECOURS	T145/80D16 P225/60R17	420 KPA, 60 PSI 200 KPA, 29 PSI		

CARGO

=



+

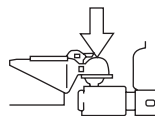

**Cargo Weight** – includes all weight added to the Base Curb Weight, including cargo and optional equipment. When towing, trailer tongue load or king pin weight is also part of cargo weight.

**GAW (Gross Axle Weight)** – is the total weight placed on each axle (front and rear) – including vehicle curb weight and all payload.

202

2007 Freestar (win)  
Owners Guide (post-2002-fmt)  
USA (fus)

## Tires, Wheels and Loading

**GAWR (Gross Axle Weight Rating)** – is the maximum allowable weight that can be carried by a single axle (front or rear). **These numbers are shown on the Safety Compliance Certification Label located on the B-Pillar or the edge of the driver's door. The total load on each axle must never exceed its GAWR.**

**Note:** For trailer towing information refer to *Trailer towing* found in this chapter or the *RV and Trailer Towing Guide* provided by your authorized dealer.

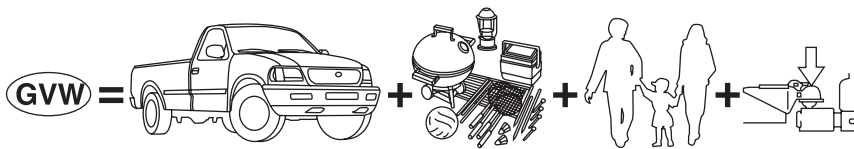

**GVW (Gross Vehicle Weight)** – is the Vehicle Curb Weight + cargo + passengers.

**GVWR (Gross Vehicle Weight Rating)** – is the maximum allowable weight of the fully loaded vehicle (including all options, equipment, passengers and cargo). **The GVWR is shown on the Safety Compliance Certification Label located on the B-Pillar or the edge of the driver's door. The GVW must never exceed the GVWR.**

MFD. BY FORD MOTOR CO.			
DATE: XX/XX	GVWR: XXXXLB/ XXXXKKG		
FRONT GAWR: XXXXL	REAR GAWR: XXXXLB		
XXXXKKG	WITH	XXXXKKG	WITH
XXXX/XXXXXXXX	TIRES	XXXX/XXXXXXXX	TIRES
XXXX.XX	RIMS	XXXX.XX	RIMS
AT XXX kPa/XX	PSI COLD	AT XXX kPa/XX	PSI COLD
THIS VEHICLE CONFORMS TO ALL APPLICABLE FEDERAL MOTOR VEHICLE SAFETY AND THEFT PREVENTION STANDARDS IN EFFECT ON THE DATE OF MANUFACTURE SHOWN ABOVE.			
VIN: XXXXXXXXXXXXXXXXX		XXXXX	XXXXX
TYPE: XXX			
EXT PNT: XX	RC: XX	DSO:	
WB <sup>1</sup> BRK <sup>1</sup> INT TR <sup>1</sup> TP/PS <sup>1</sup> R <sup>1</sup> AXLE <sup>1</sup> TR SPR <sup>1</sup> XXXXX			
XXX X XX X XX X XX XXX			
XXXXXXXXXXXX XXX XXXX-XXXXXX-XX			



Exceeding the Safety Compliance Certification Label vehicle weight rating limits could result in substandard vehicle handling or performance, engine, transmission and/or structural damage, serious damage to the vehicle, loss of control and personal injury.

## Tires, Wheels and Loading

$$\text{GCW} = \text{GVW} + \text{Trailer}$$

**GCW (Gross Combined Weight)** – is the weight of the loaded vehicle (GVW) plus the weight of the fully loaded trailer.

**GCWR (Gross Combined Weight Rating)** – is the maximum allowable weight of the vehicle and the loaded trailer – including all cargo and passengers – that the vehicle can handle without risking damage.

(Important: The towing vehicles' braking system is rated for operation at GVWR, not at GCWR. Separate functional brakes should be used for safe control of towed vehicles and for trailers where the GCW of the towing vehicle plus the trailer exceed the GVWR of the towing vehicle. **The GCW must never exceed the GCWR.**

**Maximum Loaded Trailer Weight** – is the highest possible weight of a fully loaded trailer the vehicle can tow. It assumes a vehicle with only mandatory options, no cargo (internal or external), a tongue load of 10–15% (conventional trailer) or king pin weight of 15–25% (fifth wheel trailer), and driver only (150 lb. [68 kg]). **Consult your authorized dealer (or the *RV and Trailer Towing Guide* provided by your authorized dealer) for more detailed information.**



Do not exceed the GVWR or the GAWR specified on the Safety Compliance Certification Label.



Do not use replacement tires with lower load carrying capacities than the originals because they may lower the vehicle's GVWR and GAWR limitations. Replacement tires with a higher limit than the originals do not increase the GVWR and GAWR limitations.



Exceeding any vehicle weight rating limitation could result in serious damage to the vehicle and/or personal injury.

### Steps for determining the correct load limit:

1. Locate the statement “The combined weight of occupants and cargo should never exceed XXX kg or XXX lbs.” on your vehicle's placard.

## Tires, Wheels and Loading

2. Determine the combined weight of the driver and passengers that will be riding in your vehicle.
3. Subtract the combined weight of the driver and passengers from XXX kg or XXX lbs.
4. The resulting figure equals the available amount of cargo and luggage load capacity. For example, if the “XXX” amount equals 1,400 lbs. and there will be five 150 lb. passengers in your vehicle, the amount of available cargo and luggage load capacity is 650 lbs. ( $1400 - 750 (5 \times 150) = 650$  lb.). In metric units ( $635 - 340 (5 \times 68) = 295$  kg.)
5. Determine the combined weight of luggage and cargo being loaded on the vehicle. That weight may not safely exceed the available cargo and luggage load capacity calculated in Step 4.
6. If your vehicle will be towing a trailer, load from your trailer will be transferred to your vehicle. Consult this manual to determine how this reduces the available cargo and luggage load capacity of your vehicle.

The following gives you a few examples on how to calculate the available amount of cargo and luggage load capacity:

- Another example for your vehicle with 1400 lb. (635 kg) of cargo and luggage capacity. You decide to go golfing. Is there enough load capacity to carry you, 4 of your friends and all the golf bags? You and four friends average 220 lb. (99 kg) each and the golf bags weigh approximately 30 lb. (13.5 kg) each. The calculation would be:  $1400 - (5 \times 220) - (5 \times 30) = 1400 - 1100 - 150 = 150$  lb. Yes, you have enough load capacity in your vehicle to transport four friends and your golf bags. In metric units, the calculation would be:  $635 \text{ kg} - (5 \times 99 \text{ kg}) - (5 \times 13.5 \text{ kg}) = 635 - 495 - 67.5 = 72.5$  kg.
- A final example for your vehicle with 1400 lb. (635 kg) of cargo and luggage capacity. You and one of your friends decide to pick up cement from the local home improvement store to finish that patio you have been planning for the past 2 years. Measuring the inside of the vehicle with the rear seat folded down, you have room for 12-100 lb. (45 kg) bags of cement. Do you have enough load capacity to transport the cement to your home? If you and your friend each weigh 220 lb. (99 kg), the calculation would be:  $1400 - (2 \times 220) - (12 \times 100) = 1400 - 440 - 1200 = -240$  lb. No, you do not have enough cargo capacity to carry that much weight. In metric units, the calculation would be:  $635 \text{ kg} - (2 \times 99 \text{ kg}) - (12 \times 45 \text{ kg}) = 635 - 198 - 540 = -103$  kg. You will need to reduce the load weight by at least 240 lb. (104 kg). If you remove 3-100 lb. (45 kg) cement bags, then the load calculation would be:

## Tires, Wheels and Loading

$1400 - (2 \times 220) - (9 \times 100) = 1400 - 440 - 900 = 60$  lb. Now you have the load capacity to transport the cement and your friend home. In metric units, the calculation would be:  $635 \text{ kg} - (2 \times 99 \text{ kg}) - (9 \times 45 \text{ kg}) = 635 - 198 - 405 = 32$  kg.

The above calculations also assume that the loads are positioned in your vehicle in a manner that does not overload the Front or the Rear Gross Axle Weight Rating specified for your vehicle on the Safety Compliance Certification Label found on the edge of the driver's door.

### TRAILER TOWING

Your vehicle is capable either of towing Class I trailers or up to Class II trailers when equipped with the optional trailer tow package.

If your vehicle does not have the optional trailer tow package your vehicle is partially prepped for trailer tow lamp wiring but you will also need to install electrical kit (15A416). This kit contains fuses and relays to isolate the vehicle lighting circuitry from the trailer lighting and an adapter wiring harness containing the standard 4-pin trailer plug. Refer to the *Trailer lamps* section in this chapter for additional information.

**Do not tow above 2,000 lb. (907 kg) without the manufacturer-installed trailer tow package.**

A new underbody wiring harness (14406) will be a component to this kit and will need to be installed, if applicable, per instructions located in the service kit.

If your vehicle has the optional trailer tow package it comes with heavy duty cooling fans, auxiliary transmission fluid cooler, an auxiliary engine oil cooler (4.2L engine only), heavy duty battery, trailer tow wiring (including fuses and relays to isolate the vehicle lighting circuitry from the trailer lighting) and a kit (in a cardboard box) that includes an adapter wiring harness that contains the standard 4-pin trailer plug.

Trailer towing puts additional loads on your vehicle's engine, transmission, axle, brakes, tires, and suspension. For your safety and to maximize vehicle performance, be sure to use the proper equipment while towing.

Follow these guidelines to ensure safe towing procedure:

- Stay within your vehicle's load limits. If exceeded, cargo should be removed from the trailer and/or the vehicle until all weights are within specified limits.
- Thoroughly prepare your vehicle for towing. Refer to *Preparing to tow* in this chapter.

## Tires, Wheels and Loading

- Use extra caution when driving while trailer towing. Refer to *Driving while you tow* in this chapter.
- Service your vehicle more frequently if you tow a trailer. Refer to *Special Operating Conditions* in the scheduled maintenance information.
- Do not tow a trailer until your vehicle has been driven at least 500 miles (800 km).
- Refer to the instructions included with towing accessories for the proper installation and adjustment specifications.

Vehicle towing capability/ Trailer hitch requirement			Trailer	
Model/ Engine	GCWR - lb. (kg)	Hitch type required	Trailer Weight range - lb. (kg)	Tongue load
Van, 3.9L	7000 (3175)	Class I Non- Equalizing Weight Carrying	0-2000 (0-907)	10-15% of TW (200 lb. [91 kg] maximum)
Wagon, 3.9L				
Wagon, 4.2L	7200 (3266)			
Wagon, 3.9L with trailer tow option	8500 (3856)	Class II Non- Equalizing Weight Carrying	0-3500 (0-1588)	10-15% of TW (350 lb. [159 kg] maximum)
Wagon, 4.2L with trailer tow option	8700 (3946)			

Do not exceed the maximum loads listed on the Safety Compliance Certification label. For load specification terms found on the label, refer to *Vehicle loading* in this chapter. Remember to figure in the tongue load of your loaded trailer when figuring the total weight.



Towing trailers beyond the maximum recommended gross trailer weight exceeds the limit of the vehicle and could result in engine damage, transmission damage, structural damage, loss of control and personal injury.

## Tires, Wheels and Loading

### Preparing to tow

Use the proper equipment for towing a trailer and make sure it is properly attached to your vehicle. See your authorized dealer or a reliable trailer dealer if you require assistance.

### Hitches

Do not use hitches that clamp onto the vehicle bumper. Use a load carrying hitch that does not exceed your vehicle's capability. See the *Tongue Load* section in the trailer towing chart earlier in this section for range details on a specific trailer load.

### Safety chains

Always connect the trailer's safety chains to the hook retainers on the hitch. To connect the trailer's safety chains, cross the chains under the trailer tongue and allow slack for turning corners.

If you use a rental trailer, follow the instructions that the rental agency gives to you.

**Do not attach safety chains to the bumper.**

### Trailer brakes

Be sure your trailer conforms to all applicable local and Federal Regulations regarding trailer braking. If your trailer is equipped with electronically controlled brakes you will need to have an electronic brake controller with associated wiring installed to your vehicle by an authorized dealer.



Do not connect a trailer's hydraulic brake system directly to your vehicle's brake system. Your vehicle may not have enough braking power and your chances of having a collision greatly increase.

The braking system of the tow vehicle is rated for operation at the GVWR not GCWR.

### Trailer lamps

Trailer lamps are required on most towed vehicles. Make sure all running lights, brake lights, turn signals and hazard lights are working.

**Do not splice into the vehicle lamp wiring for trailer lamps. Your vehicle uses an advanced electronic module to control and monitor your vehicle lamps. Splicing into the wiring or attaching wiring to the vehicle bulb. may DISABLE the rear vehicle lamps**



## Tires, Wheels and Loading

**or cause them not to function properly. Your lamp outage feature may also be disabled or provide incorrect information.**

See your authorized dealer or trailer rental agency for proper instructions and equipment for hooking up trailer lamps.

### Driving while you tow

When towing a trailer:

- Keep your speed no faster than 70 mph (112 km/h) during the first 500 miles (800 km) of towing a trailer, and don't make full throttle starts.
- Turn off the speed control. The speed control may shut off automatically when you are towing on long, steep grades.
- Consult your local motor vehicle speed regulations for towing a trailer.
- To eliminate excessive shifting, use a lower gear. This will also assist in transmission cooling. (For additional information, refer to *Understanding the gearshift positions of the 4-speed automatic transmission* in the *Driving* chapter.)
- Anticipate stops and brake gradually.
- Do not exceed the GCWR rating or transmission damage may occur.

### Servicing after towing

If you tow a trailer for long distances, your vehicle will require more frequent service intervals. Refer to your *Scheduled Maintenance Information* for more information.

### Trailer towing tips

- Practice turning, stopping and backing up before starting on a trip to get the feel of the vehicle trailer combination. When turning, make wider turns so the trailer wheels will clear curbs and other obstacles.
- Allow more distance for stopping with a trailer attached.
- If you are driving down a long or steep hill, shift to a lower gear. Do not apply the brakes continuously, as they may overheat and become less effective.
- The trailer tongue weight should be 10–15% of the loaded trailer weight.
- If you will be towing a trailer frequently in hot weather, hilly conditions, at GCWR, or any combination of these factors, consider refilling your rear axle with synthetic gear lube if not already so

## Tires, Wheels and Loading

equipped. Refer to the *Maintenance and Specifications* chapter for the lubricant specification. Remember that regardless of the rear axle lube used, do not tow a trailer for the first 500 miles (800 km) of a new vehicle, and that the first 500 miles (800 km) of towing be done at no faster than 70 mph (112 km/h) with no full throttle starts.

- After you have traveled 50 miles (80 km), thoroughly check your hitch, electrical connections and trailer wheel lug nuts.
- To aid in engine/transmission cooling and A/C efficiency during hot weather while stopped in traffic, place the gearshift lever in P (Park).
- Vehicles with trailers should not be parked on a grade. If you must park on a grade, place wheel chocks under the trailer's wheels.

### RECREATIONAL TOWING

Follow these guidelines for your specific powertrain combination to tow your vehicle with all four wheels on the ground (such as behind a recreational vehicle).

These guidelines are designed to ensure that your transmission is not damaged due to insufficient lubrication.

#### **All Front Wheel Drive (FWD) vehicles:**

It is not recommended to tow front wheel drive vehicles with the front drive wheels on the ground. It is recommended to tow your vehicle with the drive wheels on a dolly or two wheel car hauling trailer.

In case of a roadside emergency with a disabled vehicle (without access to wheel dollies, car hauling trailer or flatbed transport vehicle) your vehicle can be flat towed (all wheels on the ground) under the following conditions:

- Place the transmission in N (Neutral).
- Maximum speed is 35 mph (56 km/h).
- Maximum distance is 50 miles (80 km).

### STARTING

#### Positions of the ignition

1. ACCESSORY, allows the electrical accessories such as the radio to operate while the engine is not running.

2. LOCK, locks the steering wheel, automatic transmission gearshift lever and allows key removal.

3. OFF, shuts off the engine and all accessories without locking the steering wheel. This position also allows the automatic transmission shift lever to be moved from the P (Park) position without the brake pedal being depressed.

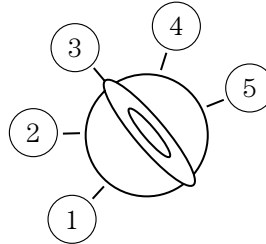

 When the key is in the ignition and in the OFF position, the automatic transmission shift lever can be moved from the P (Park) position without the brake pedal depressed. To avoid unwanted vehicle movement, always set the parking brake.

4. ON, all electrical circuits operational. Warning lights illuminated. Key position when driving.

5. START, cranks the engine. Release the key as soon as the engine starts.

#### Preparing to start your vehicle

Engine starting is controlled by the powertrain control system. This system meets all Canadian Interference-Causing Equipment standard requirements regulating the impulse electrical field strength of radio noise.

When starting a fuel-injected engine, avoid pressing the accelerator before or during starting. Only use the accelerator when you have difficulty starting the engine. For more information on starting the vehicle, refer to *Starting the engine* in this chapter.

 Extended idling at high engine speeds can produce very high temperatures in the engine and exhaust system, creating the risk of fire or other damage.

## Driving

 Do not park, idle, or drive your vehicle in dry grass or other dry ground cover. The emission system heats up the engine compartment and exhaust system, which can start a fire.

 Do not start your vehicle in a closed garage or in other enclosed areas. Exhaust fumes can be toxic. Always open the garage door before you start the engine. See *Guarding against exhaust fumes* in this chapter for more instructions.

 If you smell exhaust fumes inside your vehicle, have your dealer inspect your vehicle immediately. Do not drive if you smell exhaust fumes.

### **Important safety precautions**

When the engine starts, the idle RPM runs faster to warm the engine. If the engine idle speed does not slow down automatically, have the vehicle checked.

Before starting the vehicle:

1. Make sure all occupants buckle their safety belts. For more information on safety belts and their proper usage, refer to the *Seating and Safety Restraints* chapter.
2. Make sure the headlamps and electrical accessories are off.
3. Make sure the gearshift is in P (Park).
4. Make sure the parking brake is set.

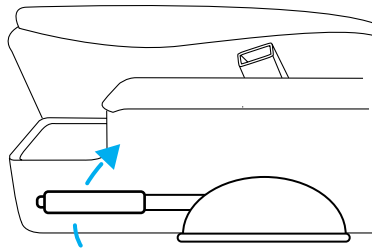

- Turn the key to 4 (ON) without turning the key to 5 (START).

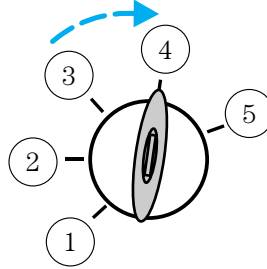

Some warning lights will briefly illuminate. See *Warning lights and chimes* in the *Instrument Cluster* chapter for more information regarding the warning lights.

### Starting the engine

**Note:** Whenever you start your vehicle, release the key as soon as the engine starts. Excessive cranking could damage the starter.

1. Turn the key to 5 (START) without pressing the accelerator pedal and release as soon as the engine starts. The key will return to 4 (ON).
2. When the engine starts, release the key.

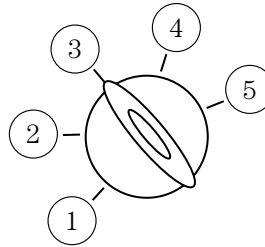

**Note:** If the engine does not start within five seconds on the first try, turn the key to 3 (OFF), wait 10 seconds and try again. If the engine still fails to start, press the accelerator to the floor and try again; this will allow the engine to crank with the fuel shut off in case the engine is flooded with fuel.

### Guarding against exhaust fumes

Carbon monoxide is present in exhaust fumes. Take precautions to avoid its dangerous effects.



If you smell exhaust fumes inside your vehicle, have your dealer inspect your vehicle immediately. Do not drive if you smell exhaust fumes.

## Driving

### Important ventilating information

If the engine is idling while the vehicle is stopped for a long period of time, open the windows at least one inch (2.5 cm) or adjust the heating or air conditioning to bring in fresh air.

### ENGINE BLOCK HEATER (IF EQUIPPED)

An engine block heater warms the engine coolant which aids in starting and heater/defroster performance. Use of an engine block heater is strongly recommended if you live in a region where temperatures reach -10°F (-23°C) or below. For best results, plug the heater in at least three hours before starting the vehicle. The heater can be plugged in the night before starting the vehicle.



To reduce the risk of electrical shock, do not use your heater with ungrounded electrical systems or two-pronged (cheater) adapters.

### BRAKES

Occasional brake noise is normal. If a metal-to-metal, continuous grinding or continuous squeal sound is present, the brake linings may be worn-out and should be inspected by an authorized dealer. If the vehicle has continuous vibration or shudder in the steering wheel while braking, the vehicle should be inspected by an authorized dealer.

Refer to *Brake system warning light* in the *Instrument Cluster* chapter for information on the brake system warning light.



### Four-wheel anti-lock brake system (ABS)

Your vehicle is equipped with an Anti-lock Braking System (ABS). This system helps you maintain steering control during emergency stops by keeping the brakes from locking. Noise from the ABS pump motor and brake pedal pulsation may be observed during ABS braking and the brake pedal may suddenly travel a little farther as soon as ABS braking is done and normal brake operation resumes. These are normal characteristics of the ABS and should be no reason for concern.

**ABS warning lamp**

The ABS lamp in the instrument cluster momentarily illuminates when the ignition is turned on. If the light does not illuminate during start up, remains on or flashes, the ABS may be disabled and may need to be serviced.



Even when the ABS is disabled, normal braking is still effective. (If your BRAKE warning lamp illuminates with the parking brake released, have your brake system serviced immediately by an authorized dealer.)



**Using ABS**

When hard braking is required, apply continuous force on the brake pedal; do not pump the brake pedal since this will reduce the effectiveness of the ABS and will increase your vehicle's stopping distance. The ABS will be activated if wheelslip or skidding is detected, optimizing your stopping distance and allowing you to retain steering control.

**Brake Assist (if equipped as part of the AdvanceTrac® system)**

The Brake Assist system provides full braking force during panic braking situations. It detects a rapid application of the brake pedal and maximizes the amount of brake booster assist, helping the driver to achieve maximum braking pressure. Once a panic brake application is detected, the system will remain activated as long as the brake pedal is depressed. The system is deactivated by releasing the brake pedal.

When the system activates, the brake pedal will travel with very little effort; this is normal.

## Driving

### Parking brake

To set the parking brake, pull the handle up as far as possible. The BRAKE warning lamp will illuminate and will remain illuminated until the parking brake is released.

To release, press and hold the button, pull the handle up slightly, then push the handle down.



Always set the parking brake fully and make sure that the gearshift is securely latched in P (Park).

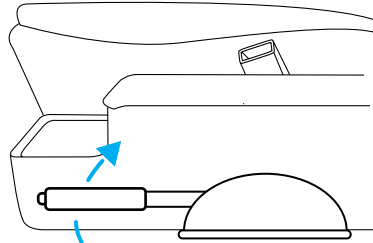

### ADVANCETRAC® STABILITY ENHANCEMENT SYSTEM (IF EQUIPPED)

The AdvanceTrac® system helps the driver maintain the stability and steer-ability of the vehicle. The system integrates anti-lock braking system (ABS) and Traction Control™ and a more advanced function to further enhance the stability of the vehicle.

AdvanceTrac® constantly monitors the vehicle motion relative to the driver's intended course. This is done by using added sensors that compare the steering inputs from the driver with the actual motion of the vehicle. AdvanceTrac® determines whether an engine torque reduction or brake application is needed to help control the vehicle. If the vehicle begins to rotate excessively left or right, spin out, or slide sideways, the system will attempt to correct the excessive motion. If the vehicle does not respond to steering inputs, the system will attempt to increase the turning response of the vehicle.

AdvanceTrac® enhances your vehicle's stability during maneuvers that require all available tire traction, like in wet/snowy/icy road conditions and/or when performing emergency maneuvers. In an emergency lane-change, the driver will experience better overall vehicle traction, and have better control of the vehicle.

Driving conditions which may activate AdvanceTrac® include:

- Accelerating on a slippery surface
- Taking a turn too fast



## Driving

- Maneuvering quickly to avoid an accident, pedestrian or obstacle
- Hitting a patch of ice
- Changing lanes on a snow-rutted road
- Entering a snow-free road from a snow-covered side street, or vice versa
- Entering a paved road from a gravel road, or vice versa
- Hitting a curb while turning
- Cornering at excessive speeds while towing a heavily loaded trailer (refer to *Trailer Towing* in this chapter)

The AdvanceTrac® system automatically turns on when the engine is started. However, the system does not function when the vehicle is traveling in R (Reverse).

If you are operating the speed control system and road conditions change causing the AdvanceTrac® to activate, the AdvanceTrac® will disengage the speed control. When driving conditions permit, you can return to speed control by pressing RESUME. Refer to *Speed control* in the *Driver controls* chapter.

The AdvanceTrac® button allows the driver to control the availability of the AdvanceTrac® system.

AdvanceTrac® system status is indicated by the AdvanceTrac® indicator light in the instrument cluster when the system is deactivated.

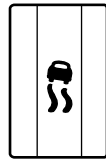

If a failure is detected in the AdvanceTrac® system, the AdvanceTrac® indicator light in the instrument cluster will stay on. Have the vehicle system serviced by an authorized dealer immediately.

If the vehicle is stuck in snow or mud or when driving in deep sand, switching off the AdvanceTrac® system may be beneficial so the wheels are allowed to spin. If your vehicle seems to lose engine power while driving in deep sand or very deep snow, switching off the AdvanceTrac® stability enhancement feature will restore full engine power and will enhance momentum through the obstacle.

Some drivers may notice a slight movement of the brake pedal when the AdvanceTrac® performs a system self-check. During AdvanceTrac® operation you may experience the following:

- A rumble or grinding noise

## Driving

- A slight deceleration of the vehicle
- The AdvanceTrac® indicator light will illuminate
- If your foot is on the brake pedal, you will feel a vibration in the pedal.
- If the driving condition is severe and your foot is not on the brake, the brake pedal will move to apply higher brake forces. You may also hear a whoosh of air from under the instrument panel during this severe condition.

All these conditions are normal during AdvanceTrac® operation.

If the AdvanceTrac system is activated for an extended period of time, the brake portion of the system will shut down to allow the brakes to cool down. A limited AdvanceTrac® function using only engine power reduction will still help control the wheels from over-spinning. When the brakes have cooled down, the system will again function normally.

Anti-lock braking is not affected by this condition and will function normally during the cool-down period.

**Do not alter or modify your vehicle's suspension or steering; the resulting changes to the vehicle's handling can adversely affect the AdvanceTrac® system. Also, do not install a stereo loudspeaker near the front center console or under either front seat. The speaker vibrations can adversely affect the AdvanceTrac® sensors located in this area.**



Aggressive driving in any road conditions can cause you to lose control of your vehicle increasing the risk of severe personal injury or property damage. The occurrence of an AdvanceTrac® event is an indication that at least some of the tires have exceeded their ability to grip the road; this may lead to an increased risk of loss of vehicle control, vehicle rollover, personal injury and death. If you experience a severe road event, SLOW DOWN.

## STEERING

To help prevent damage to the power steering system:

- Never hold the steering wheel at its furthest turning points (until it stops) for more than a few seconds when the engine is running.
- Do not operate the vehicle with a low power steering pump reservoir fluid level (below the MIN mark on the reservoir).
- Some noise is normal during operation. If the noise is excessive, check for low power steering pump fluid level before seeking service by your authorized dealer.

## Driving

- Heavy or uneven steering efforts may be caused by low power steering pump fluid level. Check for low power steering pump fluid level before seeking service by your authorized dealer.
- Do not fill the power steering pump reservoir above the MAX mark on the reservoir, as this may result in leaks from the reservoir.

If the power steering system breaks down (or if the engine is turned off), you can steer the vehicle manually, but it takes more effort.

If the steering wanders or pulls, check for:

- an improperly inflated tire
- uneven tire wear
- loose or worn suspension components
- loose or worn steering components
- improper steering alignment

A high crown in the road or high crosswinds may also make the steering seem to wander/pull.

### AUTOMATIC TRANSAXLE OPERATION

#### Brake-shift interlock

This vehicle is equipped with a brake-shift interlock feature that prevents the gearshift lever from being moved from P (Park) when the ignition is in the 4 (ON) position unless the brake pedal is depressed.

If you cannot move the gearshift lever out of P (Park) with the ignition in the 4 (ON) position and the brake pedal depressed:

1. Apply the parking brake.
2. Insert the key and turn it to the 3 (OFF) position. **Apply the brake pedal and shift to N (Neutral).**

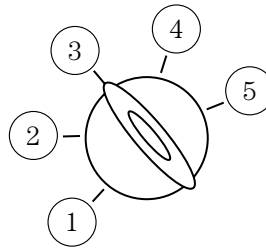



## Driving

 When the key is in the ignition and in the 3 (OFF) position, the automatic transmission shift lever can be moved from the P (Park) position without the brake pedal depressed. To avoid unwanted vehicle movement, always set the parking brake.

3. Start the vehicle.

If it is necessary to use the above procedure to move the gearshift lever, it is possible that a fuse has blown or the vehicle's brakelamps are not operating properly. Refer to *Fuses and relays* in the *Roadside Emergencies* chapter.

 Do not drive your vehicle until you verify that the brakelamps are working.

 Always set the parking brake fully and make sure the gearshift is latched in P (Park). Turn the ignition to the LOCK position and remove the key whenever you leave your vehicle.

 If the parking brake is fully released, but the brake warning lamp remains illuminated, the brakes may not be working properly. See your authorized dealer.

### Driving with an automatic overdrive transaxle with column gearshift

Your transaxle is equipped with an adaptive learning strategy found in the vehicle computer. This feature is designed to increase durability and provide consistent shift feel over the life of the vehicle. A new vehicle or transaxle may have firm and/or soft shifts. This operation is considered normal and will not affect function or durability of the transaxle. Over time, the adaptive learning process will fully update transaxle operation. Additionally, whenever the battery is disconnected or a new battery installed, the strategy must be relearned.

Your automatic overdrive transaxle provides fully automatic operation in either D (Drive) or 3. Driving with the gearshift lever in D (Drive) gives the best fuel economy for normal driving conditions. For manual control start in 1 (First) and then shift manually.

To put your vehicle in gear, start the engine, depress the brake pedal, then move gearshift lever out of P (Park). Once you place the gearshift lever securely into position, gradually release the brake pedal and use the accelerator as necessary.

220

### Understanding the gearshift positions of the 4-speed automatic transaxle

**P R N D 3 1**

#### **P (Park)**

This position locks the transaxle and prevents the front wheels from turning.

To put your vehicle in gear:

- Start the engine
- Depress the brake pedal
- Move the gearshift lever into the desired gear

To put your vehicle in P (Park):

- Come to a complete stop
- Move the gearshift lever and securely latch it in P (Park)



Always set the parking brake fully and make sure the gearshift is latched in P (Park). Turn the ignition to the LOCK position and remove the key whenever you leave your vehicle.

#### **R (Reverse)**

With the gearshift lever in R (Reverse), the vehicle will move backward. Always come to a complete stop before shifting into and out of R (Reverse).

#### **N (Neutral)**

With the gearshift lever in N (Neutral), the vehicle can be started and is free to roll. Hold the brake pedal down while in this position.

#### **D (Drive) with Overdrive**

The normal driving position for the best fuel economy. The transaxle operates in gears one through four.

#### **3 (Third)**

- This position allows for all forward gears except overdrive.
- Provides more engine braking than D (Overdrive).
- Use when driving conditions cause excessive shifting from D (Overdrive) to other gears. Examples: city traffic, hilly terrain, heavy loads, trailer towing and when engine braking is required.

## Driving

### 1 (First)

- Transaxle operates in first gear only.
- Provides maximum engine braking.
- Allows upshifts by moving gearshift lever.
- Will not downshift into 1 (First) at high speeds; allows for 1 (First) when vehicle reaches slower speeds.



When parking, do not use the gearshift in place of the parking brake. Always set the parking brake fully and make sure that the gearshift is securely latched in Park (P). Turn off the ignition whenever you leave your vehicle. Never leave your vehicle unattended while it is running. If you do not take these precautions, your vehicle may move unexpectedly and injure someone.

### If your vehicle gets stuck in mud or snow

If your vehicle gets stuck in mud or snow, it may be rocked out by shifting between forward and reverse gears, stopping between shifts in a steady pattern. Press lightly on the accelerator in each gear.

If necessary, try turning the Traction Control™ or AdvanceTrac® system off. This will allow the wheels to spin, which may help to free your stuck vehicle. For more information, refer to *Traction Control™ (if equipped)* or *AdvanceTrac® stability enhancement system (if equipped)* in this chapter.

**Do not rock the vehicle if the engine is not at normal operating temperature or damage to the transmission may occur.**

**Do not rock the vehicle for more than a minute or damage to the transmission and tires may occur, or the engine may overheat.**

### REVERSE SENSING SYSTEM (IF EQUIPPED)

The Reverse Sensing System (RSS) sounds a tone to warn the driver of obstacles near the rear bumper when the R (Reverse) is selected and the vehicle is moving at speeds less than 3 mph (5 km/h). The system is not effective at speeds above 3 mph (5 km/h) and may not detect certain angular or moving objects.



To help avoid personal injury, please read and understand the limitations of the reverse sensing system as contained in this section. Reverse sensing is only an aid for some (generally large and fixed) objects when moving in reverse on a flat surface at “parking speeds”. Inclement weather may also affect the function of the RSS; this may include reduced performance or a false activation.

## Driving



To help avoid personal injury, always use caution when in R (Reverse) and when using the RSS.



This system is not designed to prevent contact with small or moving objects. The system is designed to provide a warning to assist the driver in detecting large stationary objects to avoid damaging the vehicle. The system may not detect smaller objects, particularly those close to the ground.



Certain add-on devices such as large trailer hitches, bike or surfboard racks and any device that may block the normal detection zone of the RSS system may create false beeps.

The RSS detects obstacles up to 6 ft. (2 meters) from the rear bumper with a decreased coverage area at the outer corners of the bumper, (refer to the figures for approximate zone coverage areas). As you move closer to the obstacle, the rate of the tone increases. When the obstacle is less than 10 inches (25.0 cm) away, the tone will sound continuously. If the RSS detects a stationary or receding object further than 10 inches (25.0 cm) from the side of the vehicle, the tone will sound for only three seconds. Once the system detects an object approaching, the tone will sound again.

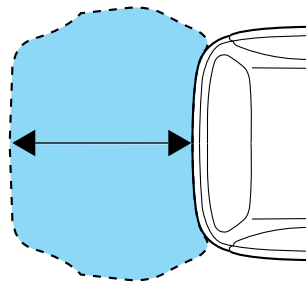
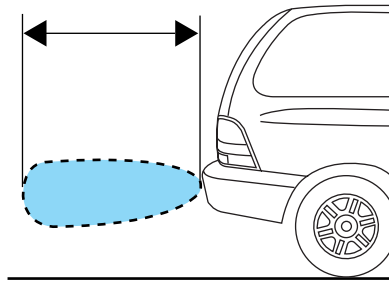

## Driving

The RSS is automatically enabled when the gear selector is placed in R (Reverse) and the ignition is ON. The park aid disable switch allows the driver to disable the RSS only when the ignition is ON, and the gear selector is in R (Reverse). The OFF indicator remains illuminated when the system is disabled. If the indicator light illuminates when the RSS is not turned off, it may indicate a failure in the RSS.



The system defaults to **enabled** every time the ignition is turned on. Press the control to disable or enable the system.

**Keep the RSS sensors (located on the rear bumper/fascia) free from snow, ice and large accumulations of dirt (do not clean the sensors with sharp objects). If the sensors are covered, it will affect the accuracy of the RSS.**

**If your vehicle sustains damage to the rear bumper/fascia, leaving it misaligned or bent, the sensing zone may be altered causing inaccurate measurement of obstacles or false alarms.**

### DRIVING THROUGH WATER

If driving through deep or standing water is unavoidable, proceed very slowly especially when the depth is not known. Never drive through water that is higher than the bottom of the wheel rims (for cars) or the bottom of the hubs (for trucks).

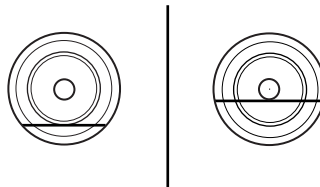

When driving through water, traction or brake capability may be limited. Also, water may enter your engine's air intake and severely damage your engine or your vehicle may stall. **Driving through deep water where the transmission vent tube is submerged may allow water into the transmission and cause internal transmission damage.**

**Once through the water, always dry the brakes by moving your vehicle slowly while applying light pressure on the brake pedal.**

Wet brakes do not stop the vehicle as quickly as dry brakes.



## Roadside Emergencies

### ROADSIDE ASSISTANCE

#### Getting roadside assistance

To fully assist you should you have a vehicle concern, Ford Motor Company offers a complimentary roadside assistance program. This program is separate from the New Vehicle Limited Warranty. The service is available:

- 24-hours, seven days a week
- for the New Vehicle Limited Warranty period of three years or 36,000 miles (60,000 km), whichever occurs first on Ford and Mercury vehicles, and four years or 50,000 miles (80,000 km) on Lincoln vehicles.

Roadside assistance will cover:

- a flat tire change with a good spare (except Ford GT which has a tire inflation kit)
- battery jump start
- lock-out assistance (key replacement cost is the customer's responsibility)
- fuel delivery – Independent Service Contractors, if not prohibited by state, local or municipal law shall deliver up to 2.0 gallons (7.5L) of gasoline or 5 gallons (18.9L) of diesel fuel to a disabled vehicle. Fuel delivery service is limited to two no-charge occurrences within a 12-month period.
- winch out – available within 100 feet (30.5 meters) of a paved or county maintained road, no recoveries.
- towing – Ford/Mercury/Lincoln eligible vehicle towed to an authorized dealer within 35 miles (56.3 km) of the disablement location or to the nearest authorized dealer. If a member requests to be towed to an authorized dealer more than 35 miles (56.3 km) from the disablement location, the member shall be responsible for any mileage costs in excess of 35 miles (56.3 km).

Trailers shall be covered up to \$100 if the disabled eligible vehicle requires service at the nearest authorized dealer. If the trailer is disabled, but the towing vehicle is operational, the trailer does not qualify for any roadside services.

#### **Canadian customers refer to your Owner Information Guide for information on:**

- coverage period

## Roadside Emergencies

- exact fuel amounts
- towing of your disabled vehicle
- emergency travel expense reimbursement
- travel planning benefits

### Using roadside assistance

Complete the roadside assistance identification card and place it in your wallet for quick reference. In the United States, this card is found in the Owner Guide portfolio in the glove compartment. In Canada, the card is found in the *Owner Information Guide* in the glove compartment.

U.S. Ford or Mercury vehicle customers who require roadside assistance, call 1-800-241-3673; Lincoln vehicle customers call 1-800-521-4140.

Canadian customers who require roadside assistance, call 1-800-665-2006.

If you need to arrange roadside assistance for yourself, Ford Motor Company will reimburse a reasonable amount. To obtain reimbursement information, U.S. Ford or Mercury vehicles customers call 1-800-241-3673; Lincoln vehicle customers call 1-800-521-4140.

Canadian customers who need to obtain reimbursement information, call 1-800-665-2006.

### Roadside coverage beyond basic warranty

In the United States, you may purchase additional roadside assistance coverage beyond this period through the Ford Auto Club by contacting your authorized dealer.

Similarly in Canada, for uninterrupted Roadside Assistance coverage, you may purchase extended coverage prior to your Basic Warranty's Roadside Assistance expiring. For more information and enrollment, contact 1-877-294-2582 or visit our website at [www.ford.ca](http://www.ford.ca).

### HAZARD FLASHER CONTROL

The hazard flasher is located on the instrument panel by the radio. The hazard flashers will operate when the ignition is in any position or if the key is not in the ignition.

Push in the flasher control and all front and rear direction signals will

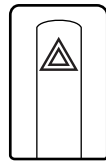

## Roadside Emergencies

flash. Press the flasher control again to turn them off. Use it when your vehicle is disabled and is creating a safety hazard for other motorists.

**Note:** With extended use, the flasher may run down your battery.

### FUEL PUMP SHUT-OFF SWITCH

This device stops the electric fuel pump from sending fuel to the engine when your vehicle has had a substantial jolt.

After an accident, if the engine cranks but does not start, this switch may have been activated.

This switch is located behind the service panel on the right side of the cargo area.

To reset the switch:

1. Turn the ignition OFF.
2. Check the fuel system for leaks.
3. If no leaks are apparent, reset the switch by pushing in on the reset button.
4. Turn the ignition ON.
5. Wait a few seconds and return the key to OFF.
6. Make another check for leaks.

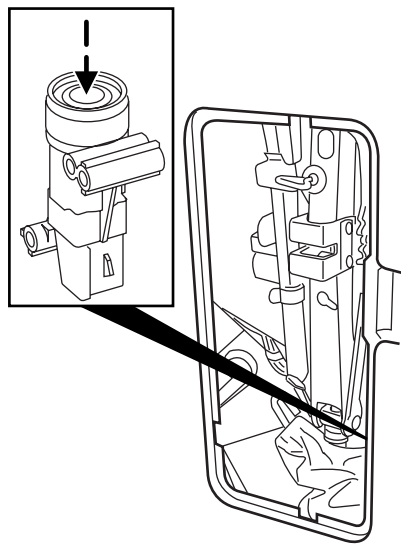

### FUSES AND RELAYS

#### Fuses

If electrical components in the vehicle are not working, a fuse may have blown. Blown fuses are identified by a broken wire within the fuse. Check the appropriate fuses before replacing any electrical components.

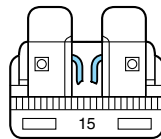

## Roadside Emergencies

**Note:** Always replace a fuse with one that has the specified amperage rating. Using a fuse with a higher amperage rating can cause severe wire damage and could start a fire.

### **Standard fuse amperage rating and color**

COLOR					
Fuse rating	Mini fuses	Standard fuses	Maxi fuses	Cartridge maxi fuses	Fuse link cartridge
2A	Grey	Grey	—	—	—
3A	Violet	Violet	—	—	—
4A	Pink	Pink	—	—	—
5A	Tan	Tan	—	—	—
7.5A	Brown	Brown	—	—	—
10A	Red	Red	—	—	—
15A	Blue	Blue	—	—	—
20A	Yellow	Yellow	Yellow	Blue	Blue
25A	Natural	Natural	—	—	—
30A	Green	Green	Green	Pink	Pink
40A	—	—	Orange	Green	Green
50A	—	—	Red	Red	Red
60A	—	—	Blue	—	Yellow
70A	—	—	Tan	—	Brown
80A	—	—	Natural	—	Black

### **Passenger compartment fuse panel**

The fuse panel is located below and to the left of the steering wheel by the brake pedal. Remove the panel cover to access the fuses. To remove the fuse panel cover, pull up on the latch on the right or left side of the cover.

To remove a fuse use the fuse puller tool provided on the fuse panel cover.

## Roadside Emergencies

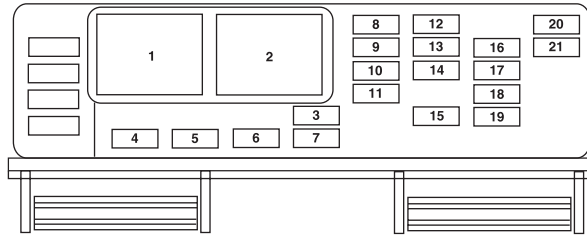

The fuses are coded as follows:

Fuse/Relay Location	Fuse Amp Rating	Passenger Compartment Fuse Panel Description
1	Relay	Accessory delay relay 1
2	Relay	Accessory delay relay 2
3	10A	Front wiper motor Run feed
4	5A	B+ feed to outside mirrors
5	20A	Vent window power feed/Radio feed
6	5A	Driver door switch illumination/Passenger door switch illumination
7	10A	Rear wiper Run feed
8	10A	Cluster/Electronic Automatic Temperature Control (EATC) B+ feed, DVD
9	10A	Passive Anti-theft System (PATS) LED feed
10	5A	Auxiliary radio
11	5A	Auxiliary climate control system/Power Liftgate Module/Left and right power sliding door module/Data Link Connector (DLC)/Clock B+ feeds

## Roadside Emergencies

Fuse/Relay Location	Fuse Amp Rating	Passenger Compartment Fuse Panel Description
12	5A	Brake-Shift Interlock (BSI) Run feed, Climate control system Run feed
13	5A	Compass/Driver heated seat/Passenger heated seats/Reverse sensing system/Power Liftgate Module/Power sliding door Run feeds
14	5A	Underhood fuse box Run feed, Front blower Run feed
15	10A	Brake On-Off (BOO) switch B+
16	5A	Steering angle/Cluster/Power sliding door and power liftgate inhibit LED/Electrochromatic mirror Run/Start/Tire Pressure Monitoring System (TPMS)
17	10A	Restraint Control Module (RCM)/Passenger Air bag Disable Indicator (PADI)/Passenger Occupant Detection System (PODS) Run/Start
18	10A	Anti-lock Brake System (ABS) module/Brake pressure switch/Speed control Run/Start
19	5A	PATS/Cluster/Air bag LED/Powertrain Control Module (PCM) relay Run/Start
20	10A	Liftgate Start feed, Radio Start feed
21	10A	Starter relay power START

## Roadside Emergencies

### Power distribution box

The power distribution box is located in the engine compartment. The power distribution box contains high-current fuses that protect your vehicle's main electrical systems from overloads.



Always disconnect the battery before servicing high current fuses.



To reduce risk of electrical shock, always replace the cover to the Power Distribution Box before reconnecting the battery or refilling fluid reservoirs.

If the battery has been disconnected and reconnected, refer to the *Battery* section of the *Maintenance and Specifications* chapter.

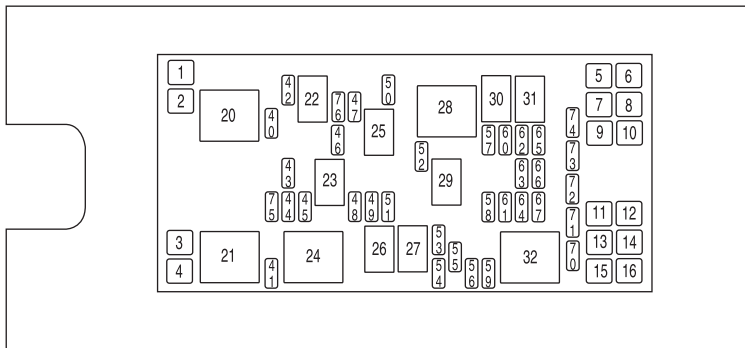

To remove the cover of the power distribution box, pull the release latches at both ends of the cover, then pull the cover up.

The high-current fuses are coded as follows:

Fuse/Relay Location	Fuse Amp Rating	Power Distribution Box Description
1	—	Not used
2	30A**	Right cooling fan

## Roadside Emergencies

Fuse/Relay Location	Fuse Amp Rating	Power Distribution Box Description
3	30A**	Left cooling fan
4	30A**	Starter solenoid
5	30A**	Right-hand power sliding door
6	30A**	SJB accessory #2 (driver power window)
7	30A**	Auxiliary blower motor
8	40A**	Anti-lock Brake System (ABS) #2 (coil power)
9	30A**	Power liftgate
10	30A**	SJB accessory #1 (passenger window, radio, vent windows)
11	30A**	Left power seat/heated seat
12	40A**	ABS #1 (pump motor)
13	40A**	Rear defroster
14	30A**	Front climate control system blower motor
15	30A**	Right power seat/heated seat
16	30A**	Left-hand power sliding door
20	Mini relay	Powertrain Control Module (PCM) power
21	Mini relay	Horn
22	Micro relay	A/C clutch
23	Micro relay	High beams
24	Mini relay	Starter
25	Micro relay	Fuel pump
26	—	Not used
27	—	Not used
28	Mini relay	Auxiliary blower
29	Micro relay	Trailer park lamps
30	Micro relay	Left trailer stop/turn lamps
31	Micro relay	Right trailer stop/turn lamps
32	Mini relay	Rear defroster



## Roadside Emergencies

Fuse/Relay Location	Fuse Amp Rating	Power Distribution Box Description
40	15A*	Engine #1 (A/C relay coil, IMRC, HEGO sensors, Canister purge, Transmission module)
41	25A*	Horn
42	10A*	A/C clutch
43	15A*	Engine #2 (Cooling fan relays, Injectors, PCM, MAF sensor, IAC, Ignition coil, ESM)
44	10A*	Heated PCV
45	15A*	High beams
46	20A*	Trailer stop/turn lamps
47	15A*	Fuel pump, Fuel pump shut-off switch
48	—	Not used
49	10A*	PCM KAP, Canister vent
50	10A*	Alternator
51	10A*	Adjustable pedals (non-memory) or memory module
52	20A*	Trailer tow park lamps
53	10A*	Heated mirrors
54	30A*	Front wiper motor
55	25A*	Rear wiper motor
56	30A*	Premium sound radio
57	—	Not used
58	30A*	SJB #1 – Center High-Mounted Stop Lamp (CHMSL), License plate lamps, OBD II, Dome lamp, Auxiliary blend doors, Switch illumination (feeds F-8, F-9, F-10 and F-11)
59	20A*	Radio (non-premium)
60	30A*	SJB #4 – Back-up lamps, Door locks

## Roadside Emergencies

Fuse/Relay Location	Fuse Amp Rating	Power Distribution Box Description
61	—	Not used
62	30A*	SJB #3 – Right cornering/auxiliary lamps, Right low beam, Left front park/turn lamps, Left rear park/stop/turn lamps, Instrument panel courtesy lamps, Step well lamps, Left signal mirror, Clock, Cluster, Message center (SJB F-15), Switch illumination for: overhead console, DVD/Rear climate control system, Headlamp switch illumination, Climate control illumination
63	20A*	Instrument panel power point, Cigar lighter
64	20A*	Ignition switch #1 feed
65	30A*	SJB #2 – Left cornering/auxiliary lamps, Left low beam, Right front park/turn lamps, Right rear park/stop/turn lamps, Puddle lamps, Mirror signals, Visors, 2nd and 3rd row lamps, Cargo lamp, Defroster indicator
66	20A*	2nd and 3rd row seat power points
67	20A*	Ignition switch #2 feed
70	—	Not used
71	—	Not used
72	—	Not used
73	—	Not used
74	—	Not used
75	Diode	PCM
76	Diode	A/C clutch

\* Mini Fuse \*\* Cartridge Fuse

## Roadside Emergencies

### Auxiliary relay box (cooling fans)

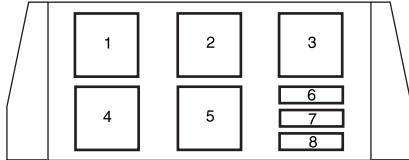

The relay box is located in the engine compartment by the radiator.

Fuse/Relay location	Fuse amp rating	Description
1	—	Cooling fan relay #4
2	—	Cooling fan relay #5
3	—	Cooling fan relay #3
4	—	Cooling fan relay #1
5	—	Cooling fan relay #2
6	40A*	Right-hand cooling fan motor (Vehicles with trailer tow package only)
7	15A**	Low-speed cooling fan circuit breaker (Vehicles with trailer tow package only)
8	40A*	Left-hand cooling fan motor (Vehicles with trailer tow package)
	10A**	Low-speed cooling fan circuit breaker (Vehicles without trailer tow package)

\* Maxi fuse \*\*Circuit breaker

### CHANGING A FLAT TIRE

If you get a flat tire while driving:

- do not brake heavily.
- gradually decrease the vehicle's speed.
- hold the steering wheel firmly.
- slowly move to a safe place on the side of the road.
- If your low tire warning light is on, refer to *Low tire warning* in this chapter.

## Roadside Emergencies



The use of tire sealants may damage your tires. The use of tire sealants may also damage your Tire Pressure Monitoring System and should not be used.



Your vehicle is equipped with a Tire Pressure Monitoring System. Refer to *Tire Pressure Monitoring System (TPMS)* in the *Tires, Wheels and Loading* chapter for important information. If the tire pressure monitor sensor becomes damaged, it will no longer function.

### Dissimilar spare tire/wheel information



Failure to follow these guidelines could result in an increased risk of loss of vehicle control, injury or death.

If you have a dissimilar spare tire/wheel, then it is intended for temporary use only. This means that if you need to use it, you should replace it as soon as possible with a road tire/wheel that is the same size and type as the road tires and wheels that were originally provided by Ford. If the dissimilar spare tire or wheel is damaged, it should be replaced rather than repaired.

A dissimilar spare tire/wheel is defined as a spare tire and/or wheel that is different in brand, size or appearance from the road tires and wheels and can be one of three types:

1. **T-type mini-spare:** This spare tire begins with the letter “T” for tire size and may have “Temporary Use Only” molded in the sidewall
2. **Full-size dissimilar spare with label on wheel:** This spare tire has a label on the wheel that states: “THIS TIRE AND WHEEL FOR TEMPORARY USE ONLY”

When driving with one of the dissimilar spare tires listed above, **do not:**

- Exceed 50 mph (80 km/h)
- Load the vehicle beyond maximum vehicle load rating listed on the Safety Compliance Label
- Tow a trailer
- Use snow chains on the end of the vehicle with the dissimilar spare tire
- Use more than one dissimilar spare tire at a time

236

## Roadside Emergencies

- Use commercial car washing equipment
- Try to repair the dissimilar spare tire

Use of one of the dissimilar spare tires listed above at any one wheel location can lead to impairment of the following:

- Handling, stability and braking performance
- Comfort and noise
- Ground clearance and parking at curbs
- Winter weather driving capability
- Wet weather driving capability

For vehicles equipped with 4WD, it is not recommended that the vehicle be operated in 4WD modes with a temporary emergency spare tire. If 4WD operation is necessary, do not operate above speeds of 10 mph (16 km/h) or for distances above 50 miles (80 km).

### 3. Full-size dissimilar spare without label on wheel

When driving with the full-size dissimilar spare tire/wheel, **do not:**

- Exceed 70 mph (113 km/h)
- Use more than one dissimilar spare tire/wheel at a time
- Use commercial car washing equipment
- Use snow chains on the end of the vehicle with the dissimilar spare tire/wheel

The usage of a full-size dissimilar spare tire/wheel can lead to impairment of the following:

- Handling, stability and braking performance
- Comfort and noise
- Ground clearance and parking at curbs
- Winter weather driving capability
- Wet weather driving capability
- All-Wheel driving capability (if applicable)
- Load leveling adjustment (if applicable)

When driving with the full-size dissimilar spare tire/wheel additional caution should be given to:

- Towing a trailer
- Driving vehicles equipped with a camper body

## Roadside Emergencies

- Driving vehicles with a load on the cargo rack

Drive cautiously when using a full-size dissimilar spare tire/wheel and seek service as soon as possible.

### Location of the spare tire and tools

**Note:** The tire pressure monitoring system (TPMS) indicator light will illuminate when the spare is in use. To restore the full functionality of the TPMS system, all road wheels equipped with the tire pressure monitoring sensors must be mounted on the vehicle

Have a flat tire serviced by an authorized dealer in order to prevent damage to the TPMS sensor, refer to *Tire Pressure Monitoring System (TPMS)* in the *Tires, Wheels and Loading* chapter. Replace the spare tire with a road tire as soon as possible.

The spare tire and tools for your vehicle are stowed in the following locations:

Item	Location
Spare tire	Under the vehicle, just forward of the rear bumper.
Jack	Behind the access panel located on the right rear quarter panel interior trim.
Jack handle	Attached to the jack with a clip.
Flat tire tether, wing screw	Inside tire tether kit, next to jack.
Jack extension tool (cargo van model only)	Attached to the jack kit.

### Removing the jack and tools

1. Locate the access panel on the interior trim. Rotate the panel retaining clip and remove the panel.
2. Remove the jack and lug nut wrench by turning the thumbscrew counterclockwise to relieve tension against the stowage bracket.

## Roadside Emergencies

### Removing the spare tire

1. **Wagon only:** Open liftgate and lift flap in the carpeting on the rear tub cargo floor to expose the hex nut. Insert the lug nut wrench on the hex nut in cargo floor.

**Cargo van only:** Lift flap in mat to expose hex nut. Insert extension tool through access hole and engage hex nut. Place lug wrench onto end nut of extension tool.

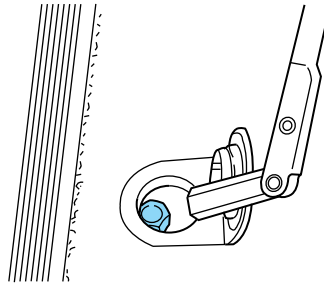

2. Turn the wrench counterclockwise until cable is slack and tire can be slid rearward.

3. Remove the primary retainer from the center of the tire.

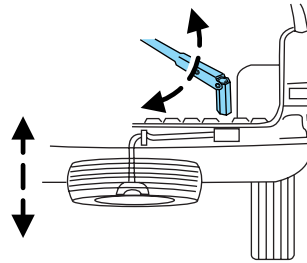

**Note:** Do not stow the full size tire or any flat tire under the vehicle.

### Stowing the primary tether

**Note:** If **no tire** is to be stowed under the vehicle, raise the primary tether by turning the wrench clockwise until the hex nut ratchets.

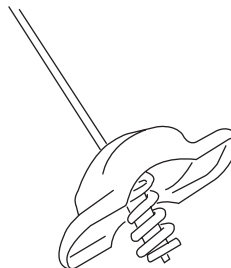

## Roadside Emergencies

### Tire change procedure

 When one of the front wheels is off the ground, the transaxle alone will not prevent the vehicle from moving or slipping off the jack, even if the vehicle is in P (Park).

 To help prevent the vehicle from moving when you change a tire, be sure the parking brake is set, then block (in both directions) the wheel that is diagonally opposite (other side and end of the vehicle) to the tire being changed.

 If the vehicle slips off the jack, you or someone else could be seriously injured.

1. Park on a level surface, activate hazard flashers and set parking brake.

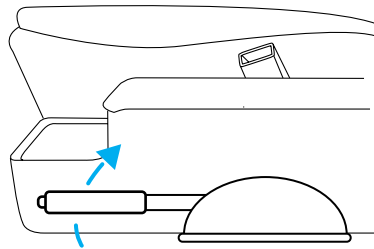

2. Place gearshift lever in P (Park), turn engine off, and block the diagonally opposite wheel.

3. Remove the spare tire, jack and lug wrench.

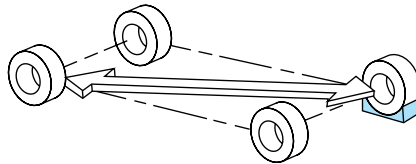



## Roadside Emergencies

4. Removing the optional wheel cover or center ornament:

- To remove a bolt-on wheel cover (if equipped) loosen the plastic nuts on the center ornament with the wheel nut wrench. Then, remove the wheel cover with the tapered end of the wheel nut wrench.
- Remove the center ornament (if equipped) from the wheel with the tapered end of the wheel nut wrench. Insert and twist the handle, then pry against the wheel.

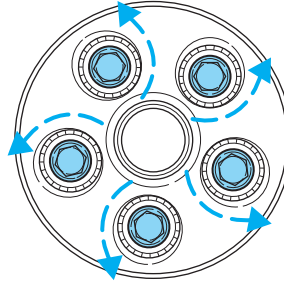

5. Loosen each wheel lug nut one-half turn counterclockwise but do not remove them until the wheel is raised off the ground.

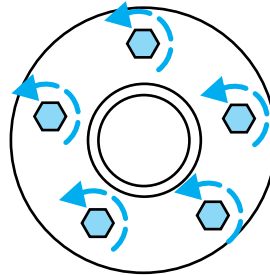

## Roadside Emergencies

If Ford Accessory Running Boards have been installed, use the jack adapters supplied with the running boards as described on the inside of the jack storage area.

6. Locate the jack notch next to the door closest to the tire you are changing, then place the jack on the frame rail directly behind the notch.

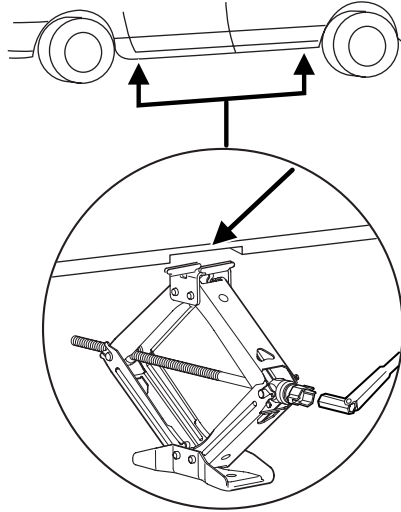

7. Turn the jack handle clockwise until the wheel is completely off the ground.

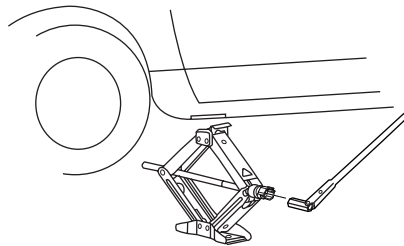

To lessen the risk of personal injury, do not put any part of your body under the vehicle while changing a tire. Do not start the engine when your vehicle is on the jack. The jack is only meant for changing the tire.

8. Remove the lug nuts with the lug wrench.

9. Replace the flat tire with the spare tire, making sure the valve stem is facing outward. Reinstall lug nuts until the wheel is snug against the hub. Do not fully tighten the lug nuts until the wheel has been lowered.

10. Lower the wheel by turning the jack handle counterclockwise.

## Roadside Emergencies

11. Remove the jack and fully tighten the lug nuts in the order shown. Refer to *Wheel lug nut torque specifications* later in this chapter for the proper lug nut torque specification.

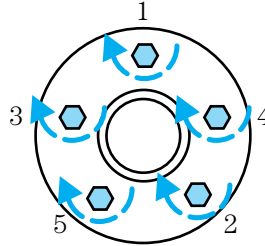

12. Installing the optional wheel cover or center ornament:

- If equipped with a bolted-on wheel cover, install the wheel cover and tighten the five plastic nuts until they click (do not use power tools on these nuts).
- If equipped with the center ornament, install the center ornament by snapping it back into place.

13. Put flat tire, jack and lug wrench away in the proper storage locations.

### Stowing the flat and full-size tire



Failure to follow these instructions may result in personal injury. Do not install the flat tire or any full size tire underneath the vehicle.

Remove tether kit from the jack storage area.

#### Wagon only:

1. Place tire upright inside the vehicle near the rear of the vehicle with the valve stem facing the front of the vehicle.
2. Pass the cable retainer through the center of the wheel.
3. Raise the tire and secure both ends of the cable with the wing nut provided in the tether cable kit, by installing it on the luggage back panel and turning the wing screw clockwise. You will hear an audible click when the tire is properly secured.
4. Check that the flat tire is properly secured.

#### Cargo van only:

1. Remove the perforated section of the vinyl mat in the center floor area in order to install the wing screw.
2. Using the tether cable kit located with the jack, pass the cable retainer through center of the wheel.

## Roadside Emergencies

3. Lay the tire flat and secure the cable with wing screw by installing it on the wing screw retainer in the floor and turning the wing screw clockwise. You will hear an audible click when the tire is properly secured.
4. Check that the flat tire is properly secured.

### **Stowing the spare tire**

1. Lay the spare, inflated tire on the ground with the valve stem facing down.
2. Insert the primary wheel retainer through the center of the wheel.
3. Use the winch mechanism to pull, and raise the tire under the vehicle.
4. **Wagon only:** Raise the tire by turning the lug nut wrench clockwise until the hex nut ratchets.

**Cargo van only:** Raise the tire by turning the jack extension tool clockwise with the lug nut wrench until the hex nut ratchets.

The effort to turn the jack handle increases significantly and the spare tire carrier ratchets or slips when the tire is raised to the maximum tightness. Tighten to the best of your ability, to the point where the ratchet/slip occurs, if possible. The spare tire carrier will not allow you to overtighten. If the spare tire carrier ratchets or slips with little effort, take the vehicle to your authorized dealer for assistance at your earliest convenience.

5. Check that the tire lies flat against the frame and is properly tightened. Try to push or pull, then turn the tire to be sure it will not move. Loosen and retighten, if necessary. Failure to properly stow the spare tire may result in failure of the winch cable and loss of the tire.  
**NOTE:** Visually check to make sure the wheel plate is resting flat against the tire.
6. Repeat this tightness check procedure when servicing the spare tire pressure (every six months, per *Scheduled Maintenance Guide*), or at any time that the spare tire is disturbed through service of other components.

## Roadside Emergencies

### WHEEL LUG NUT TORQUE SPECIFICATIONS

Retighten the lug nuts to the specified torque at 500 miles (800 km) after any wheel disturbance (rotation, flat tire, wheel removal, etc.).

Bolt size	Wheel lug nut torque*	
	lb.ft.	N•m
½ x 20	100	135

\* Torque specifications are for nut and bolt threads free of dirt and rust. Use only Ford recommended replacement fasteners.

 When a wheel is installed, always remove any corrosion, dirt or foreign materials present on the mounting surfaces of the wheel or the surface of the wheel hub, brake drum or brake disc that contacts the wheel. Ensure that any fasteners that attach the rotor to the hub are secured so they do not interfere with the mounting surfaces of the wheel. Installing wheels without correct metal-to-metal contact at the wheel mounting surfaces can cause the wheel nuts to loosen and the wheel to come off while the vehicle is in motion, resulting in loss of control.

### JUMP STARTING

 The gases around the battery can explode if exposed to flames, sparks, or lit cigarettes. An explosion could result in injury or vehicle damage.

 Batteries contain sulfuric acid which can burn skin, eyes and clothing, if contacted.

**Do not attempt to push-start your automatic transmission vehicle. Automatic transmissions do not have push-start capability. Attempting to push-start a vehicle with an automatic transmission may cause transmission damage.**

### Preparing your vehicle

When the battery is disconnected or a new battery is installed, the transmission must relearn its shift strategy. As a result, the transmission may have firm and/or soft shifts. This operation is considered normal and will not affect function or durability of the transmission. Over time, the adaptive learning process will fully update transmission operation.

## Roadside Emergencies

1. Use only a 12-volt supply to start your vehicle.
2. Do not disconnect the battery of the disabled vehicle as this could damage the vehicle's electrical system.
3. Park the booster vehicle close to the hood of the disabled vehicle making sure the two vehicles **do not** touch. Set the parking brake on both vehicles and stay clear of the engine cooling fan and other moving parts.
4. Check all battery terminals and remove any excessive corrosion before you attach the battery cables. Ensure that vent caps are tight and level.
5. Turn the heater fan on in both vehicles to protect any electrical surges. Turn all other accessories off.

### Connecting the jumper cables

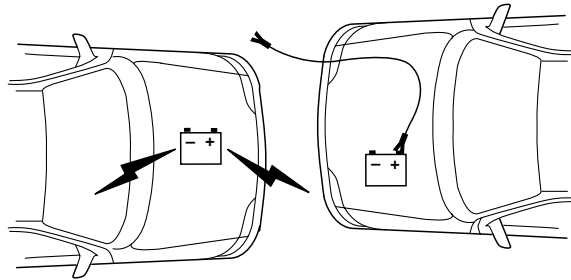

1. Connect the positive (+) jumper cable to the positive (+) terminal of the discharged battery.

**Note:** In the illustrations, *lightning bolts* are used to designate the assisting (boosting) battery.

## Roadside Emergencies

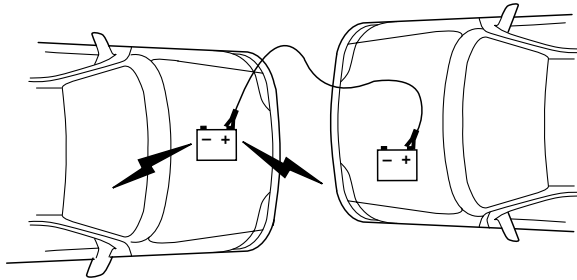

2. Connect the other end of the positive (+) cable to the positive (+) terminal of the assisting battery.

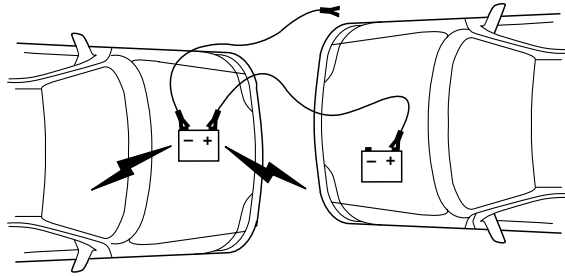

3. Connect the negative (-) cable to the negative (-) terminal of the assisting battery.

## Roadside Emergencies

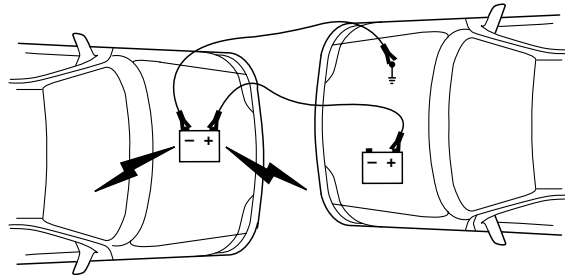

4. Make the final connection of the negative (-) cable to an exposed metal part of the stalled vehicle's engine, away from the battery and the carburetor/fuel injection system. **Do not** use fuel lines, engine rocker covers or the intake manifold as *grounding* points.



Do not connect the end of the second cable to the negative (-) terminal of the battery to be jumped. A spark may cause an explosion of the gases that surround the battery.

5. Ensure that the cables are clear of fan blades, belts, moving parts of both engines, or any fuel delivery system parts.

### Jump starting

1. Start the engine of the booster vehicle and run the engine at moderately increased speed.
2. Start the engine of the disabled vehicle.
3. Once the disabled vehicle has been started, run both engines for an additional three minutes before disconnecting the jumper cables.



## Roadside Emergencies

### Removing the jumper cables

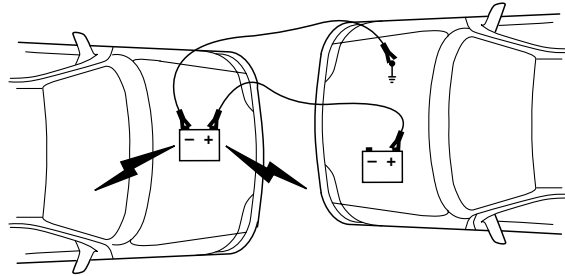

**Remove the jumper cables in the reverse order that they were connected.**

1. Remove the jumper cable from the *ground* metal surface.

**Note:** In the illustrations, *lightning bolts* are used to designate the assisting (boosting) battery.

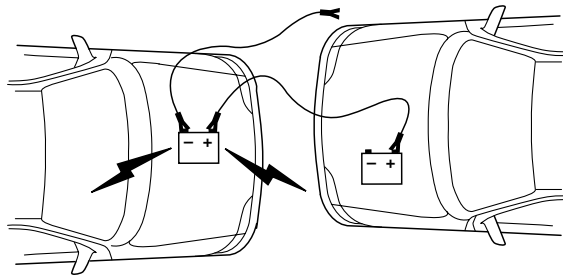

2. Remove the jumper cable on the negative (-) connection of the booster vehicle's battery.

## Roadside Emergencies

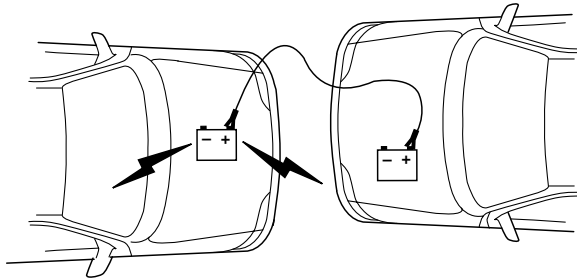

3. Remove the jumper cable from the positive (+) terminal of the booster vehicle's battery.

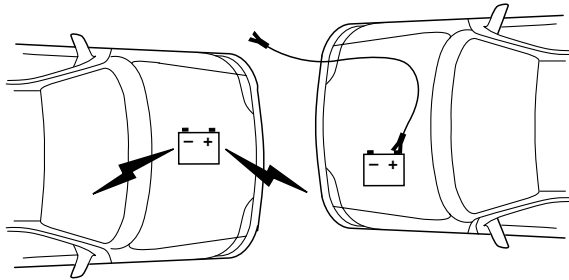

4. Remove the jumper cable from the positive (+) terminal of the disabled vehicle's battery.

After the disabled vehicle has been started and the jumper cables removed, allow it to idle for several minutes so the engine computer can *relearn* its idle conditions.

## Roadside Emergencies

### WRECKER TOWING

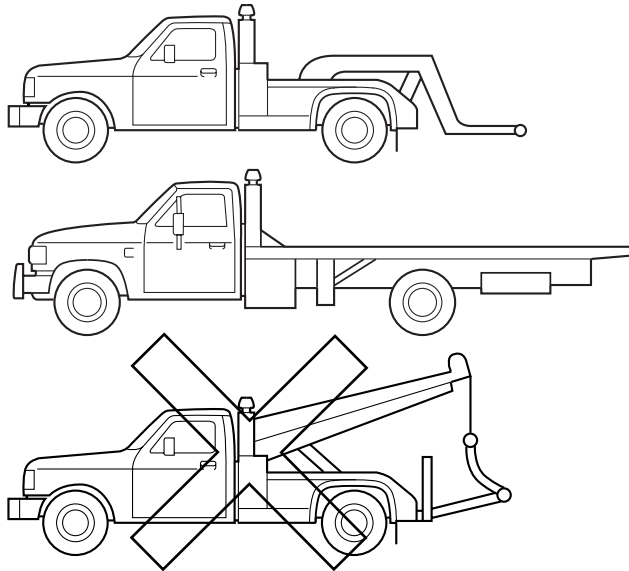

If you need to have your vehicle towed, contact a professional towing service or, if you are a member of a roadside assistance program, your roadside assistance service provider.

It is recommended that your vehicle be towed by wheel lift or flatbed equipment. Do not tow with a slingbelt. Ford Motor Company has not approved a slingbelt towing procedure.

If your vehicle is to be towed from the rear using wheel lift, the front wheels must be placed on a dolly to prevent damage to the transaxle.

If your vehicle must be towed with the drive wheels on the ground:

- Place the transaxle in N (Neutral).
- Do not exceed the distance of 50 miles (80 km).
- Do not exceed the speed of 35 mph (56 km/h).

**If the vehicle is towed by other means or incorrectly, vehicle damage may occur.**

## **Roadside Emergencies**

Ford Motor Company produces a towing manual for all authorized tow truck operators. Have your tow truck operator refer to this manual for proper hook-up and towing procedures for your vehicle.

## Customer Assistance

### GETTING THE SERVICES YOU NEED

#### At home

You must take your Ford vehicle to an authorized dealer for warranty repairs. While any authorized dealer handling your vehicle line will provide warranty service, we recommend you return to your selling authorized dealer who wants to ensure your continued satisfaction. Please note that certain warranty repairs require special training and/or equipment, so not all authorized dealers are authorized to perform all warranty repairs. This means that, depending on the warranty repair needed, you may have to take your vehicle to another authorized dealer. A reasonable time must be allowed to perform a repair after taking your vehicle to the authorized dealer. Repairs will be made using Ford or Motorcraft parts, or remanufactured or other parts that are authorized by Ford.

If you have questions or concerns, or are unsatisfied with the service you are receiving, follow these steps:

1. Contact your Sales Representative or Service Advisor at your selling/servicing authorized dealer.
2. If your inquiry or concern remains unresolved, contact the Sales Manager, Service Manager or Customer Relations Manager.
3. If you require assistance or clarification on Ford Motor Company policies or procedures, please contact the Ford Customer Relationship Center at 1-800-392-3673 (FORD).

#### Away from home

If you own a Ford or Mercury vehicle and are away from home when your vehicle needs service, or if you need more help than the authorized dealer could provide, after following the steps described above, contact the Ford Customer Relationship Center to find an authorized dealer to help you.

In the United States:

Ford Motor Company  
Customer Relationship Center  
P.O. Box 6248  
Dearborn, MI 48121  
1-800-392-3673 (FORD)  
(TDD for the hearing impaired: 1-800-232-5952)  
[www.customersaskford.com](http://www.customersaskford.com)

## Customer Assistance

In Canada:  
Customer Relationship Centre  
Ford Motor Company of Canada, Limited  
P.O. Box 2000  
Oakville, Ontario L6J 5E4  
1-800-565-3673 (FORD)  
www.ford.ca

If you own a Lincoln vehicle and are away from home when your vehicle needs service, or if you need more help than the authorized dealer could provide, after following the steps described above, contact the Ford Customer Relationship Center to find an authorized dealer to help you.

In the United States:  
Ford Motor Company  
Customer Relationship Center  
P.O. Box 6248  
Dearborn, MI 48121  
1-800-521-4140  
(TDD for the hearing impaired: 1-800-232-5952)  
www.customersaskford.com

In Canada:  
Lincoln Centre  
Ford Motor Company of Canada, Limited  
P.O. Box 2000  
Oakville, Ontario L6J 5E4  
1-800-387-9333  
www.lincolncanada.com

In order to help you service your Lincoln vehicle, please have the following information available when contacting the Lincoln Centre:

- Your telephone number (home and business)
- The name of the authorized dealer and the city where the authorized dealer is located
- The year and make of your vehicle
- The date of vehicle purchase
- The current odometer reading
- The vehicle identification number (VIN)

### **Additional Assistance**

If you still have a complaint involving a warranty dispute, you may wish to contact the Better Business Bureau (BBB) AUTO LINE program (U.S. only).

254

## Customer Assistance

In some states (in the U.S.) you must directly notify Ford in writing before pursuing remedies under your state's warranty laws. Ford is also allowed a final repair attempt in some states.

In the United States, a warranty dispute must be submitted to the BBB AUTO LINE before taking action under the Magnuson-Moss Warranty Act, or to the extent allowed by state law, before pursuing replacement or repurchase remedies provided by certain state laws. This dispute handling procedure is not required prior to enforcing state created rights or other rights which are independent of the Magnuson-Moss Warranty Act or state replacement or repurchase laws.

### **IN CALIFORNIA (U.S. ONLY)**

California Civil Code Section 1793.2(d) requires that, if a manufacturer or its representative is unable to repair a motor vehicle to conform to the vehicle's applicable express warranty after a reasonable number of attempts, the manufacturer shall be required to either replace the vehicle with one substantially identical or repurchase the vehicle and reimburse the buyer in an amount equal to the actual price paid or payable by the consumer (less a reasonable allowance for consumer use). The consumer has the right to choose whether to receive a refund or replacement vehicle.

California Civil Code Section 1793.22(b) presumes that the manufacturer has had a reasonable number of attempts to conform the vehicle to its applicable express warranties if, within the first 18 months of ownership of a new vehicle or the first 18,000 miles (29,000 km), whichever occurs first:

1. Two or more repair attempts are made on the same non-conformity likely to cause death or serious bodily injury OR
2. Four or more repair attempts are made on the same nonconformity (a defect or condition that substantially impairs the use, value or safety of the vehicle) OR
3. The vehicle is out of service for repair of nonconformities for a total of more than 30 calendar days (not necessarily all at one time)

In the case of 1 or 2 above, the consumer must also notify the manufacturer of the need for the repair of the nonconformity at the following address:

Ford Motor Company  
16800 Executive Plaza Drive  
Mail Drop 3NE-B  
Dearborn, MI 48126

## Customer Assistance

### **THE BETTER BUSINESS BUREAU (BBB) AUTO LINE PROGRAM (U.S. ONLY)**

Your satisfaction is important to Ford Motor Company and to your dealer. Experience has shown that our customers have been very successful in achieving satisfaction by following the three-step procedure outlined on the front page of the Warranty Guide. However, if your warranty concern has not been resolved using the three-step procedure, you may be eligible to participate in the BBB AUTO LINE program.

The BBB AUTO LINE program consists of two parts – mediation and arbitration. Initially, the BBB will try to resolve your question or concern through mediation. Mediation is a process through which a representative of the BBB will contact the parties and explore options for settlement of your claim. If mediation is not successful, customers with eligible claims may participate in the BBB AUTO LINE arbitration process. An arbitration hearing will be scheduled so that you can present your case in an informal setting before an impartial person. The arbitrator will consider the testimony provided and make a decision after the hearing. You are not bound by the decision but may choose to accept it. If you choose to accept the BBB AUTO LINE decision then Ford must abide by the accepted decision as well. If the arbitrator has decided in your favor and you accept the decision, the BBB AUTO LINE program will contact you to ensure that Ford has complied with the decision in a timely manner. Disputes submitted to the BBB AUTO LINE program are usually decided within forty days after you file your claim with the BBB.

To file a claim with the BBB AUTO LINE, you will be asked for your name and address, information about your vehicle, information about your concerns and any steps you have already taken to try to resolve them.

You can get more information by calling BBB AUTO LINE at 1-800-955-5100, or writing to:

BBB AUTO LINE  
4200 Wilson Boulevard, Suite 800  
Arlington, Virginia 22203-1833

**Note:** Ford Motor Company reserves the right to change eligibility limitations, modify procedures, or to discontinue this process at any time without notice and without obligation.

### **UTILIZING THE MEDIATION/ARBITRATION PROGRAM (CANADA ONLY)**

For vehicles delivered to authorized Canadian dealers. In those cases where you continue to feel that the efforts by Ford of Canada and the

256



## Customer Assistance

authorized dealer to resolve a factory-related vehicle service concern have been unsatisfactory, Ford of Canada participates in an impartial third party mediation/arbitration program administered by the Canadian Motor Vehicle Arbitration Plan (CAMVAP).

The CAMVAP program is a straight-forward and relatively speedy alternative to resolve a disagreement when all other efforts to produce a settlement have failed. This procedure is without cost to you and is designed to eliminate the need for lengthy and expensive legal proceedings.

In the CAMVAP program, impartial third-party arbitrators conduct hearings at mutually convenient times and places in an informal environment. These impartial arbitrators review the positions of the parties, make decisions and, when appropriate, render awards to resolve disputes. CAMVAP decisions are fast, fair, and final as the arbitrator's award is binding both to you and Ford of Canada.

CAMVAP services are available in all territories and provinces. For more information, without charge or obligation, call your CAMVAP Provincial Administrator directly at 1-800-207-0685.

### **FORD EXTENDED SERVICE PLAN**

You can get more protection for your new car or light truck by purchasing Ford Extended Service Plan (Ford ESP) coverage. It provides the following:

- Benefits during the warranty period depending on the plan you purchase (such as: reimbursement for rentals; coverage for certain maintenance and wear items).
- Protection against covered repair costs after your Bumper-to-Bumper Warranty expires.

You may purchase Ford ESP from any participating authorized dealer. There are several plans available in various time, distance and deductible combinations which can be tailored to fit your own driving needs. Ford ESP also offers reimbursement benefits for towing and rental coverage.

When you buy Ford ESP, you receive Peace-of-Mind protection throughout the United States and Canada, provided by a network of more than 4,600 participating authorized dealers.

If you did not take advantage of the Ford Extended Service Plan at the time of purchasing your vehicle, you may still be eligible. Since this information is subject to change, please ask your authorized dealer for complete details about Ford Extended Service Plan coverage options, or visit the Ford ESP website at [www.ford-esp.com](http://www.ford-esp.com).

## Customer Assistance

### GETTING ASSISTANCE OUTSIDE THE U.S. AND CANADA

Before exporting your vehicle to a foreign country, contact the appropriate foreign embassy or consulate. These officials can inform you of local vehicle registration regulations and where to find unleaded fuel.

If you cannot find unleaded fuel or can only get fuel with an anti-knock index lower than is recommended for your vehicle, contact a regional office or owner relations/customer relationship office.

The use of leaded fuel in your vehicle without proper conversion may damage the effectiveness of your emission control system and may cause engine knocking or serious engine damage. Ford Motor Company/Ford of Canada is not responsible for any damage caused by use of improper fuel. Using leaded fuel may also result in difficulty importing your vehicle back into the U.S.

If your vehicle must be serviced while you are traveling or living in Central America, the Caribbean, or the Middle East, contact the nearest authorized dealer. If the authorized dealer cannot help you, write or call:

FORD MOTOR COMPANY  
WORLDWIDE DIRECT MARKET OPERATIONS  
1555 Fairlane Drive  
Fairlane Business Park #3  
Allen Park, Michigan 48101  
U.S.A.  
Telephone: (313) 594-4857  
FAX: (313) 390-0804

If you are in another foreign country, contact the nearest authorized dealer. If the authorized dealer employees cannot help you, they can direct you to the nearest Ford affiliate office.

If you buy your vehicle in North America and then relocate outside of the U.S. or Canada, register your vehicle identification number (VIN) and new address with Ford Motor Company Worldwide Direct Market Operations.

**Customers in the U.S. should call 1-800-392-3673.**

### ORDERING ADDITIONAL OWNER'S LITERATURE

To order the publications in this portfolio, contact Helm, Incorporated at:

HELM, INCORPORATED  
P.O. Box 07150  
Detroit, Michigan 48207

258

*2007 Freestar (win)  
Owners Guide (post-2002-fmt)  
USA (fus)*

## Customer Assistance

Or call:

**For a free publication catalog, order toll free: 1-800-782-4356**

Monday-Friday 8:00 a.m. - 6:00 p.m. EST

Helm, Incorporated can also be reached by their website:  
[www.helminc.com](http://www.helminc.com).

*(Items in this catalog may be purchased by credit card, check or money order.)*

### Obtaining a French owner's guide

French Owner's Guides can be obtained from your authorized dealer or by writing to Ford Motor Company of Canada, Limited, Service Publications, P.O. Box 1580, Station B, Mississauga, Ontario L4Y 4G3.

### REPORTING SAFETY DEFECTS (U.S. ONLY)

If you believe that your vehicle has a defect which could cause a crash or could cause injury or death, you should immediately inform the National Highway Traffic Safety Administration (NHTSA) in addition to notifying Ford Motor Company.



If NHTSA receives similar complaints, it may open an investigation, and if it finds that a safety defect exists in a group of vehicles, it may order a recall and remedy campaign. However, NHTSA cannot become involved in individual problems between you, your dealer, or Ford Motor Company.

To contact NHTSA, you may call the Vehicle Safety Hotline toll-free at 1-888-327-4236 (TTY: 1-800-424-9153); go to <http://www.safercar.gov>; or write to:

Administrator  
NHTSA  
400 Seventh Street, SW  
Washington, D.C. 20590

You can also obtain other information about motor vehicle safety from <http://www.safercar.gov>.

## Cleaning

### WASHING THE EXTERIOR

Wash your vehicle regularly with cool or lukewarm water and a neutral pH shampoo, such as Motorcraft Detail Wash (ZC-3-A), which is available from your authorized dealer.

- Never use strong household detergents or soap, such as dish washing or laundry liquid. These products can discolor and spot painted surfaces.
- Never wash a vehicle that is “hot to the touch” or during exposure to strong, direct sunlight.
- Always use a clean sponge or car wash mitt with plenty of water for best results.
- Dry the vehicle with a chamois or soft terry cloth towel in order to eliminate water spotting.
- It is especially important to wash the vehicle regularly during the winter months, as dirt and road salt are difficult to remove and cause damage to the vehicle.
- Immediately remove items such as gasoline, diesel fuel, bird droppings and insect deposits because they can cause damage to the vehicle’s paintwork and trim over time.
- Remove any exterior accessories, such as antennas, before entering a car wash.
- **Suntan lotions and insect repellents can damage any painted surface; if these substances come in contact with your vehicle, wash off as soon as possible.**

### Exterior chrome

- Wash the vehicle first, using cool or lukewarm water and a neutral pH shampoo, such as Motorcraft Detail Wash (ZC-3-A).
- Use Custom Brite Metal Cleaner (ZC-15), available from your authorized dealer. Apply the product as you would a wax to clean bumpers and other chrome parts; allow the cleaner to dry for a few minutes, then wipe off the haze with a clean, dry rag.
- **Never use abrasive materials such as steel wool or plastic pads as they can scratch the chrome surface.**

### WAXING

Applying Motorcraft Paint Sealant (ZC-45) to your vehicle every six months will assist in reducing minor scratches and paint damage.

- Wash the vehicle first.
- Do not use waxes that contain abrasives; use Motorcraft Premium Liquid Wax (ZC-53-A), which is available from your authorized dealer, or an equivalent quality product.
- Do not allow paint sealant to come in contact with any non-body (low-gloss black) colored trim, such as grained door handles, roof racks, bumpers, side moldings, mirror housings or the windshield cowl area. The paint sealant will “gray” or stain the parts over time.

### PAINT CHIPS

Your authorized dealer has touch-up paint and sprays to match your vehicle’s color. Take your color code (printed on a sticker in the driver’s door jamb) to your authorized dealer to ensure you get the correct color.

- Remove particles such as bird droppings, tree sap, insect deposits, tar spots, road salt and industrial fallout before repairing paint chips.
- Always read the instructions before using the products.

### ALUMINUM WHEELS AND WHEEL COVERS

Aluminum wheels and wheel covers are coated with a clearcoat paint finish. In order to maintain their shine:

- Clean weekly with Motorcraft Wheel and Tire Cleaner (ZC-37-A), which is available from your authorized dealer. Heavy dirt and brake dust accumulation may require agitation with a sponge. Rinse thoroughly with a strong stream of water.
- Never apply any cleaning chemical to hot or warm wheel rims or covers.
- Some automatic car washes may cause damage to the finish on your wheel rims or covers. Chemical-strength cleaners, or cleaning chemicals, in combination with brush agitation to remove brake dust and dirt, could wear away the clearcoat finish over time.
- Do not use hydrofluoric acid-based or high caustic-based wheel cleaners, steel wool, fuels or strong household detergent.
- To remove tar and grease, use Motorcraft Bug and Tar Remover (ZC-42), available from your authorized dealer.

## Cleaning

### ENGINE

Engines are more efficient when they are clean because grease and dirt buildup keep the engine warmer than normal. When washing:

- Take care when using a power washer to clean the engine. The high-pressure fluid could penetrate the sealed parts and cause damage.
- Do not spray a hot engine with cold water to avoid cracking the engine block or other engine components.
- Spray Motorcraft Engine Shampoo and Degreaser (ZC-20) on all parts that require cleaning and pressure rinse clean.

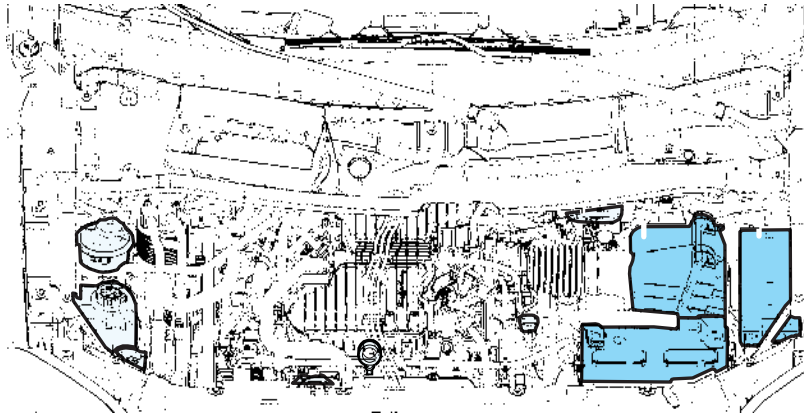

- Cover the highlighted areas to prevent water damage when cleaning the engine.
- Never wash or rinse the engine while it is running; water in the running engine may cause internal damage.

### PLASTIC (NON-PAINTED) EXTERIOR PARTS

Use only approved products to clean plastic parts. These products are available from your authorized dealer.

- For routine cleaning, use Motorcraft Detail Wash (ZC-3-A).
- If tar or grease spots are present, use Motorcraft Bug and Tar Remover (ZC-42).
- For plastic headlamp lenses, use Motorcraft Ultra Clear Spray Glass Cleaner (ZC-23).

262

### WINDOWS AND WIPER BLADES

The windshield, rear and side windows and the wiper blades should be cleaned regularly. If the wipers do not wipe properly, substances on the vehicle's glass or the wiper blades may be the cause. These may include hot wax treatments used by commercial car washes, water repellent coatings, tree sap, or other organic contamination; these contaminants may cause squeaking or chatter noise from the blades, and streaking and smearing of the windshield. To clean these items, follow these tips:

- The windshield, rear windows and side windows may be cleaned with a non-abrasive cleaner such as Motorcraft Ultra-Clear Spray Glass Cleaner (ZC-23), available from your authorized dealer.
- The wiper blades can be cleaned with isopropyl (rubbing) alcohol or Motorcraft Premium Windshield Washer Concentrate (ZC-32-A), available from your authorized dealer. This washer fluid contains special solution in addition to alcohol which helps to remove the hot wax deposited on the wiper blade and windshield from automated car wash facilities. Be sure to replace wiper blades when they appear worn or do not function properly.
- Do not use abrasives, as they may cause scratches.
- Do not use fuel, kerosene, or paint thinner to clean any parts.

If you cannot remove those streaks after cleaning with the glass cleaner or if the wipers chatter and move in a jerky motion, clean the outer surface of the windshield and the wiper blades using a sponge or soft cloth with a neutral detergent or mild-abrasive cleaning solution. After cleaning, rinse the windshield and wiper blades with clean water. The windshield is clean if beads do not form when you rinse the windshield with water.

**Do not use sharp objects, such as a razor blade, to clean the inside of the rear window or to remove decals, as it may cause damage to the rear window defroster's heated grid lines.**

### INSTRUMENT PANEL AND CLUSTER LENS

Clean the instrument panel with a damp cloth, then with a clean, dry cloth, or use Motorcraft Dash & Vinyl Cleaner (ZC-38-A).

- Avoid cleaners or polish that increase the gloss of the upper portion of the instrument panel. The dull finish in this area helps protect the driver from undesirable windshield reflection.

## Cleaning



Do not use chemical solvents or strong detergents when cleaning the steering wheel or instrument panel to avoid contamination of the airbag system.

- Be certain to wash or wipe your hands clean if you have been in contact with certain products such as insect repellent and suntan lotion in order to avoid possible damage to the interior painted surfaces.

### INTERIOR TRIM

- Clean the interior trim areas with a damp cloth, then with a clean, dry cloth; you may also use Motorcraft Dash & Vinyl Cleaner (ZC-38-A).
- Do not use household or glass cleaners as these may damage the finish.

### INTERIOR

For fabric, carpets, cloth seats, safety belts and seats equipped with side airbags:

- Remove dust and loose dirt with a vacuum cleaner.
- Remove light stains and soil with Motorcraft Professional Strength Carpet & Upholstery Cleaner (ZC-54).
- If grease or tar is present on the material, spot-clean the area first with Motorcraft Spot and Stain Remover (ZC-14).
- If a ring forms on the fabric after spot cleaning, clean the entire area immediately (but do not oversaturate) or the ring will set.
- Do not use household cleaning products or glass cleaners, which can stain and discolor the fabric and affect the flame retardant abilities of the seat materials.



Do not use cleaning solvents, bleach or dye on the vehicle's safety belts, as these actions may weaken the belt webbing.



Do not use chemical solvents or strong detergents when cleaning the seat-mounted side airbag (if equipped). Such products could contaminate the side airbag system and affect performance of the side airbag in a collision.



## Cleaning

### LEATHER SEATS (IF EQUIPPED)

Your leather seating surfaces have a clear, protective coating over the leather.

- To clean, use a soft cloth with Motorcraft Deluxe Leather and Vinyl Cleaner (ZC-11-A). Dry the area with a soft cloth.
- To help maintain its resiliency and color, use the Motorcraft Deluxe Leather Care Kit (ZC-11-D), available from your authorized dealer.
- Do not use household cleaning products, alcohol solutions, solvents or cleaners intended for rubber, vinyl and plastics, or oil/petroleum-based leather conditioners. These products may cause premature wearing of the clear, protective coating.

**Note:** In some instances, color or dye transfer can occur when wet clothing comes in contact with leather upholstery. If this occurs, the leather should be cleaned immediately to avoid permanent staining.

### UNDERBODY

Flush the complete underside of your vehicle frequently. Keep body and door drain holes free from packed dirt.

### FORD AND LINCOLN MERCURY CAR CARE PRODUCTS

Your Ford or Lincoln Mercury authorized dealer has many quality products available to clean your vehicle and protect its finishes. These quality products have been specifically engineered to fulfill your automotive needs; they are custom designed to complement the style and appearance of your vehicle. Each product is made from high quality materials that meet or exceed rigid specifications. For best results, use the following products or products of equivalent quality:

Motorcraft Bug and Tar Remover (ZC-42)

Motorcraft Car Care Kit (ZC-26)

Motorcraft Car Wash (Canada only) (CXC-21)

Motorcraft Custom Bright Metal Cleaner (ZC-15)

Motorcraft Custom Clear Coat Polish (ZC-8-A)

Motorcraft Custom Vinyl Protectant (U.S. only) (ZC-40-A)

Motorcraft Dash and Vinyl Cleaner (ZC-38-A)

Motorcraft Deluxe Leather and Vinyl Cleaner (U.S. only) (ZC-11-A)

Motorcraft Detail Wash (ZC-3-A)

Motorcraft Dusting Cloth (ZC-24)

## Cleaning

Motorcraft Engine Shampoo and Degreaser (U.S. only) (ZC-20)  
Motorcraft Engine Shampoo (Canada only) (CXC-66-A)  
Motorcraft One Step Wash and Wax Concentrate (ZC-6-A)  
Motorcraft Paint Sealant (ZC-45)  
Motorcraft Premium Car Wash Concentrate (U.S. only) (ZC-17-B)  
Motorcraft Premium Glass Cleaner (Canada only) (CXC-100)  
Motorcraft Premium Liquid Wax (ZC-53-A)  
Motorcraft Premium Windshield Washer Concentrate (ZC-32-A)  
Motorcraft Professional Strength Carpet & Upholstery Cleaner (ZC-54)  
Motorcraft Spot and Stain Remover (U.S. only) (ZC-14)  
Motorcraft Tire Clean and Shine (ZC-28)  
Motorcraft Triple Clean (U.S. only) (ZC-13)  
Motorcraft Ultra-Clear Spray Glass Cleaner (ZC-23)  
Motorcraft Vinyl Cleaner (Canada only) (CXC-93)  
Motorcraft Wheel and Tire Cleaner (ZC-37-A)

## Maintenance and Specifications

### SERVICE RECOMMENDATIONS

To help you service your vehicle we provide *scheduled maintenance information* which makes tracking routine service easy.

If your vehicle requires professional service, your authorized dealer can provide the necessary parts and service. Check your *Warranty Guide/Owner Information Guide* to find out which parts and services are covered.

Use only recommended fuels, lubricants, fluids and service parts conforming to specifications. Motorcraft parts are designed and built to provide the best performance in your vehicle.

### PRECAUTIONS WHEN SERVICING YOUR VEHICLE

- Do not work on a hot engine.
- Make sure that nothing gets caught in moving parts.
- Do not work on a vehicle with the engine running in an enclosed space, unless you are sure you have enough ventilation.
- Keep all open flames and other lit material away from the battery and all fuel related parts.

#### Working with the engine off

1. Set the parking brake and shift to P (Park).
2. Turn off the engine and remove the key.
3. Block the wheels.

#### Working with the engine on

1. Set the parking brake and shift to P (Park).
2. Block the wheels.



To reduce the risk of vehicle damage and/or personal burn injuries do not start your engine with the air cleaner removed and do not remove it while the engine is running.

## Maintenance and Specifications

### OPENING THE HOOD

1. Inside the vehicle, pull the hood release handle located under the bottom left corner of the instrument panel.

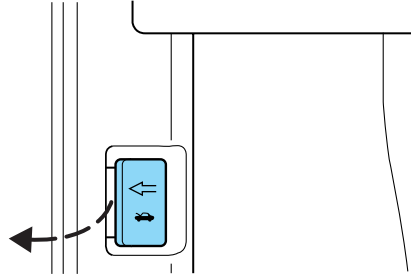

2. Go to the front of the vehicle and release the auxiliary latch that is located under the front center of the hood.

3. Lift the hood and secure it with the prop rod. Your vehicle's hood has two locations for the prop rod to be placed. These locations provide two different hood opening positions. Use the location which best suits your needs.

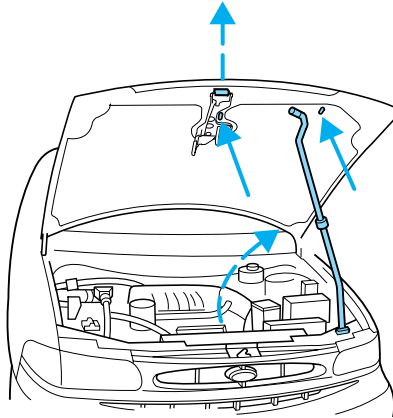

## Maintenance and Specifications

### IDENTIFYING COMPONENTS IN THE ENGINE COMPARTMENT

#### 3.9L/4.2L V6 engines

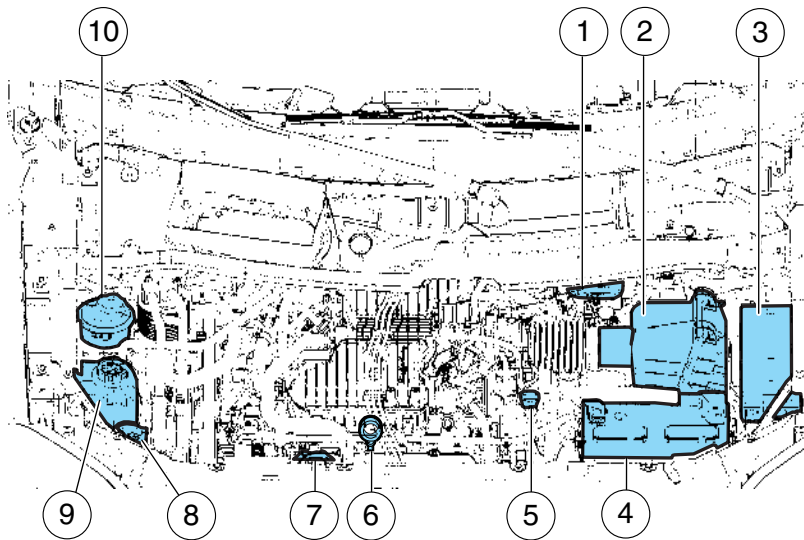

1. Brake fluid reservoir
2. Air filter assembly
3. Power distribution box
4. Battery
5. Automatic transmission fluid dipstick
6. Engine oil dipstick
7. Engine oil filler cap
8. Windshield washer fluid reservoir
9. Engine coolant reservoir
10. Power steering fluid reservoir

## Maintenance and Specifications

### WINDSHIELD WASHER FLUID

Add fluid to fill the reservoir if the level is low. In very cold weather, do not fill the reservoir completely.

Only use a washer fluid that meets Ford specification WSB-M8B16-A2. Do not use any special washer fluid such as windshield water repellent type fluid or bug wash. They may cause squeaking, chatter noise, streaking and smearing. Refer to the *Maintenance product specifications and capacities* section in this chapter.

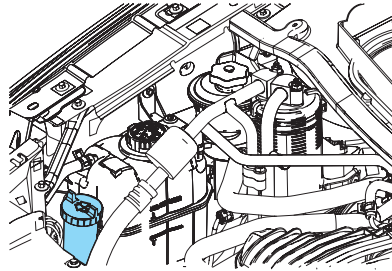

State or local regulations on volatile organic compounds may restrict the use of methanol, a common windshield washer antifreeze additive. Washer fluids containing non-methanol antifreeze agents should be used only if they provide cold weather protection without damaging the vehicle's paint finish, wiper blades or washer system.



If you operate your vehicle in temperatures below 40° F (4.5°C), use washer fluid with antifreeze protection. Failure to use washer fluid with antifreeze protection in cold weather could result in impaired windshield vision and increase the risk of injury or accident.

**Note:** Do not put washer fluid in the engine coolant reservoir. Washer fluid placed in the cooling system may harm engine and cooling system components.

### Checking and adding washer fluid for the liftgate

Washer fluid for the liftgate is supplied by the same reservoir as the windshield.

## Maintenance and Specifications

### CHANGING THE WIPER BLADES

To replace the wiper blades:

1. Pull the wiper arm away from the windshield and lock into the service position.
2. Turn the blade at an angle from the wiper arm. Push the lock pin manually to release the blade and pull the wiper blade down toward the windshield to remove it from the arm.
3. Attach the new wiper to the wiper arm and press it into place until a click is heard.

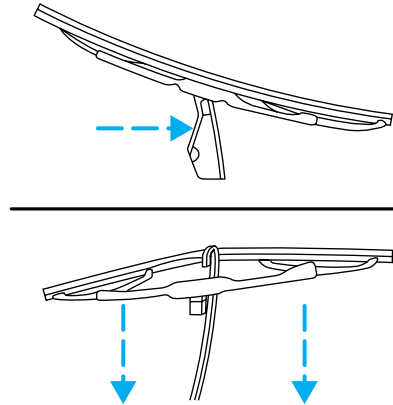

Replace wiper blades at least once per year for optimum performance.

Poor wiper quality can be improved by cleaning the wiper blades and windshield, refer to *Windows and wiper blades* in the *Cleaning* chapter.

To prolong the life of the wiper blades, it is highly recommended to scrape off the ice on the windshield before turning on the wipers. The layer of ice has many sharp edges and can damage the micro edge of the wiper rubber element.

### ENGINE OIL

#### Checking the engine oil

Refer to the *scheduled maintenance information* for the appropriate intervals for checking the engine oil.

1. Make sure the vehicle is on level ground.
2. Turn the engine off and wait a few minutes for the oil to drain into the oil pan.
3. Set the parking brake and ensure the gearshift is securely latched in P (Park).
4. Open the hood. Protect yourself from engine heat.

## Maintenance and Specifications

5. Locate and carefully remove the engine oil level indicator (dipstick).

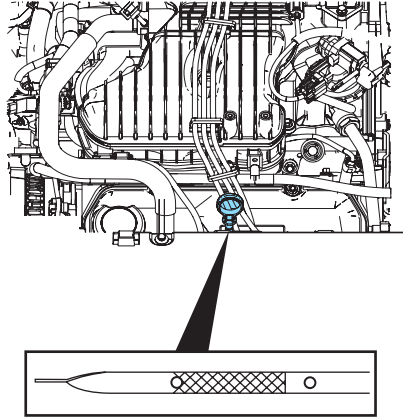

6. Wipe the indicator clean. Insert the indicator fully, then remove it again.

- If the oil level is **within this range**, the oil level is acceptable. **DO NOT ADD OIL.**

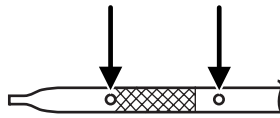

- If the oil level is **below this mark**, engine **oil must be added** to raise the level within the normal operating range.

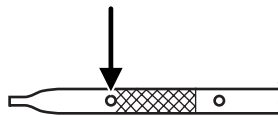

- If required, add engine oil to the engine. Refer to *Adding engine oil* in this chapter.

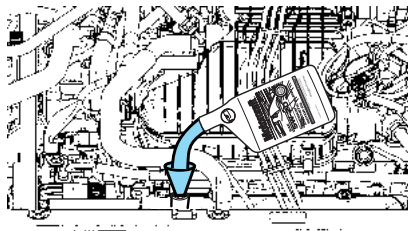



## Maintenance and Specifications

- **Do not overfill the engine with oil. Oil levels above this mark may cause engine damage.** If the engine is overfilled, some oil must be removed from the engine by an authorized dealer.

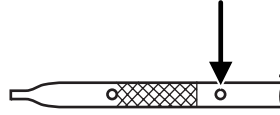

7. Put the indicator back in and ensure it is fully seated.

### Adding engine oil

1. Check the engine oil. For instructions, refer to *Checking the engine oil* in this chapter.
2. If the engine oil level is not within the normal range, add only certified engine oil of the recommended viscosity. Remove the engine oil filler cap and use a funnel to pour the engine oil into the opening.
3. Recheck the engine oil level. Make sure the oil level is not above the normal operating range on the engine oil level indicator (dipstick).
4. Install the indicator and ensure it is fully seated.
5. Fully install the engine oil filler cap by turning the filler cap clockwise 1/4 of a turn until three clicks are heard or until the cap is fully seated.

**To avoid possible oil loss, DO NOT operate the vehicle with the engine oil level indicator and/or the engine oil filler cap removed.**

### Engine oil and filter recommendations

Look for this certification trademark.

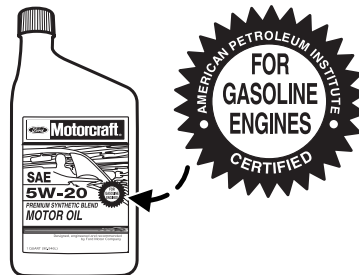

### Use SAE 5W-20 engine oil.

Only use oils “Certified For Gasoline Engines” by the American Petroleum Institute (API). An oil with this trademark symbol conforms to the current engine and emission system protection standards and fuel

## Maintenance and Specifications

economy requirements of the International Lubricant Standardization and Approval Committee (ILSAC), comprised of U.S. and Japanese automobile manufacturers.

To protect your engine's warranty use Motorcraft SAE 5W-20 or an equivalent SAE 5W-20 oil meeting Ford specification WSS-M2C930-A.

**SAE 5W-20 oil provides optimum fuel economy and durability performance meeting all requirements for your vehicle's engine.**

Do not use supplemental engine oil additives, cleaners or other engine treatments. They are unnecessary and could lead to engine damage that is not covered by Ford warranty.

Change your engine oil and filter according to the appropriate schedule listed in *scheduled maintenance information*.

Ford production and aftermarket (Motorcraft) oil filters are designed for added engine protection and long life. If a replacement oil filter is used that does not meet Ford material and design specifications, start-up engine noises or knock may be experienced.

It is recommended you use the appropriate Motorcraft oil filter (or another brand meeting Ford specifications) for your engine application.

### BATTERY

Your vehicle is equipped with a Motorcraft maintenance-free battery which normally does not require additional water during its life of service.

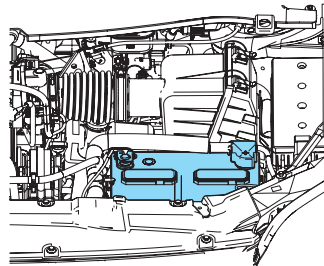

**If your battery has a cover/shield, make sure it is reinstalled after the battery has been cleaned or replaced.**

For longer, trouble-free operation, keep the top of the battery clean and dry. Also, make certain the battery cables are always tightly fastened to the battery terminals.

If you see any corrosion on the battery or terminals, remove the cables from the terminals and clean with a wire brush. You can neutralize the acid with a solution of baking soda and water.

274

## Maintenance and Specifications

It is recommended that the negative battery cable terminal be disconnected from the battery if you plan to store your vehicle for an extended period of time. This will minimize the discharge of your battery during storage.

 Batteries normally produce explosive gases which can cause personal injury. Therefore, do not allow flames, sparks or lighted substances to come near the battery. When working near the battery, always shield your face and protect your eyes. Always provide proper ventilation.

 When lifting a plastic-cased battery, excessive pressure on the end walls could cause acid to flow through the vent caps, resulting in personal injury and/or damage to the vehicle or battery. Lift the battery with a battery carrier or with your hands on opposite corners.

 Keep batteries out of reach of children. Batteries contain sulfuric acid. Avoid contact with skin, eyes or clothing. Shield your eyes when working near the battery to protect against possible splashing of acid solution. In case of acid contact with skin or eyes, flush immediately with water for a minimum of 15 minutes and get prompt medical attention. If acid is swallowed, call a physician immediately.

 Battery posts, terminals and related accessories contain lead and lead compounds. **Wash hands after handling.**

To account for customer driving habits and conditions, your automatic transaxle electronically controls the shift feel by using an adaptive learning strategy. This feature is designed to optimize shift smoothness. It is normal for your transaxle to shift abruptly during the first few hundred kilometers (miles) of operation until the adaptive strategy has been learned. The adaptive learning strategy is maintained by power from the battery. When the battery is disconnected or a new battery is installed, the transaxle must relearn its adaptive strategy. Optimal shifting will resume within a few hundred kilometers (miles) of operation.

Because your vehicle's engine is electronically controlled by a computer, some control conditions are maintained by power from the battery. When the battery is disconnected or a new battery is installed, the engine must

## Maintenance and Specifications

relearn its idle and fuel trim strategy for optimum driveability and performance. To begin this process:

1. With the vehicle at a complete stop, set the parking brake.
  2. Put the gearshift in P (Park), turn off all accessories and start the engine.
  3. Run the engine until it reaches normal operating temperature.
  4. Allow the engine to idle for at least one minute.
  5. Turn the A/C on and allow the engine to idle for at least one minute.
  6. With your foot on the brake pedal and with the A/C on, put the vehicle in D (Drive) and allow the engine to idle for at least one minute.
  7. Drive the vehicle to complete the relearning process.
- The vehicle may need to be driven 10 miles (16 km) or more to relearn the idle and fuel trim strategy.
  - **If you do not allow the engine to relearn its idle trim, the idle quality of your vehicle may be adversely affected until the idle trim is eventually relearned.**

If the battery has been disconnected or a new battery has been installed, the clock and the preset radio stations must be reset once the battery is reconnected.

If the battery has been discharged, disconnected or a new battery has been installed, the power sliding door may need to be reset. Refer to *Power Sliding Door-Resetting the PSD* in the *Driver Controls* chapter.

- Always dispose of automotive batteries in a responsible manner. Follow your local authorized standards for disposal. Call your local authorized recycling center to find out more about recycling automotive batteries.

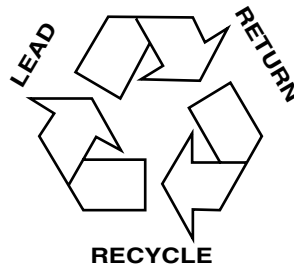

### ENGINE COOLANT

#### Checking engine coolant

The concentration and level of engine coolant should be checked at the intervals listed in *scheduled maintenance information*. The coolant

## Maintenance and Specifications

concentration should be maintained at 50/50 coolant and distilled water, which equates to a freeze point of  $-34^{\circ}\text{F}$  ( $-36^{\circ}\text{C}$ ). Coolant concentration testing is possible with a hydrometer or antifreeze tester (such as the Rotunda Battery and Antifreeze Tester, 014-R1060). The level of coolant should be maintained at the “FULL COLD” level or within the “COLD FILL RANGE” in the coolant reservoir. If the level falls below, add coolant per the instructions in the *Adding engine coolant* section.

Your vehicle was factory-filled with a 50/50 engine coolant and water concentration. If the concentration of coolant falls below 40% or above 60%, the engine parts could become damaged or not work properly. **A 50–50 mixture of coolant and water provides the following:**

- **Freeze protection down to  $-34^{\circ}\text{F}$  ( $-36^{\circ}\text{C}$ ).**
- **Boiling protection up to  $265^{\circ}\text{F}$  ( $129^{\circ}\text{C}$ ).**
- **Protection against rust and other forms of corrosion.**
- **Enables calibrated gauges to work properly.**

When the engine is cold, check the level of the engine coolant in the reservoir.

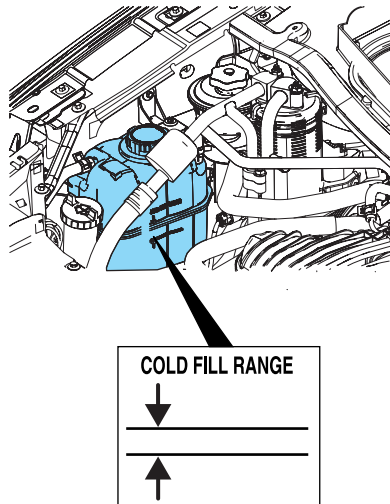

- The engine coolant should be at the “FULL COLD” level or within the “COLD FILL RANGE” as listed on the engine coolant reservoir (depending upon application).
- Refer to *scheduled maintenance information* for service interval schedules.

## Maintenance and Specifications

- Be sure to read and understand *Precautions when servicing your vehicle* in this chapter.

If the engine coolant has not been checked at the recommended interval, the engine coolant reservoir may become low or empty. If the reservoir is low or empty, add engine coolant to the reservoir. Refer to *Adding engine coolant* in this chapter.

**Note:** Automotive fluids are not interchangeable; do not use engine coolant, antifreeze or windshield washer fluid outside of its specified function and vehicle location.

### Adding engine coolant

When adding coolant, make sure it is a 50/50 mixture of engine coolant and distilled water. Add the mixture to the coolant reservoir, **when the engine is cool**, until the appropriate fill level is obtained.



Do not add engine coolant when the engine is hot. Steam and scalding liquids released from a hot cooling system can burn you badly. Also, you can be burned if you spill coolant on hot engine parts.



Do not put engine coolant in the windshield washer fluid container. If sprayed on the windshield, engine coolant could make it difficult to see through the windshield.

- **Add Motorcraft Premium Gold Engine Coolant or equivalent meeting Ford specification WSS-M97B51-A1.** Refer to *Maintenance product specifications and capacities* in this chapter.

**Note:** Use of Motorcraft Cooling System Stop Leak Pellets or an equivalent product meeting Ford specification WSS-M99B37-B6, may darken the color of Motorcraft Premium Gold Engine Coolant from yellow to golden tan.

- **Do not add/mix an orange-colored, extended life coolant such as Motorcraft Specialty Orange Engine Coolant, meeting Ford specification WSS-M97B44-D, with the factory-filled coolant.** Mixing Motorcraft Specialty Orange Engine Coolant or any orange-colored extended life product with your factory filled coolant can result in degraded corrosion protection.
- A large amount of water without engine coolant may be added, in case of emergency, to reach a vehicle service location. In this instance, the cooling system must be drained and refilled with a 50/50 mixture of engine coolant and distilled water as soon as possible. Water alone (without engine coolant) can cause engine damage from corrosion, overheating or freezing.

## Maintenance and Specifications

- **Do not use alcohol, methanol, brine or any engine coolants mixed with alcohol or methanol antifreeze (coolant).** Alcohol and other liquids can cause engine damage from overheating or freezing.
- **Do not add extra inhibitors or additives to the coolant.** These can be harmful and compromise the corrosion protection of the engine coolant.

For vehicles with overflow coolant systems with a non-pressurized cap on the coolant recovery system, add coolant to the coolant recovery reservoir when the engine is cool. Add the proper mixture of coolant and water to the “FULL COLD” level. For all other vehicles which have a coolant degas system with a pressurized cap, or if it is necessary to remove the coolant pressure relief cap on the radiator of a vehicle with an overflow system, follow these steps to add engine coolant.



To reduce the risk of personal injury, make sure the engine is cool before unscrewing the coolant pressure relief cap. The cooling system is under pressure; steam and hot liquid can come out forcefully when the cap is loosened slightly.

1. Before you begin, turn the engine off and let it cool.
2. When the engine is cool, wrap a thick cloth around the coolant pressure relief cap on the coolant reservoir (a translucent plastic bottle). Slowly turn cap counterclockwise (left) until pressure begins to release.
3. Step back while the pressure releases.
4. When you are sure that all the pressure has been released, use the cloth to turn it counterclockwise and remove the cap.
5. Fill the coolant reservoir slowly with the proper coolant mixture (see above), to within the “COLD FILL RANGE” or the “FULL COLD” level on the reservoir. If you removed the radiator cap in an overflow system, fill the radiator until the coolant is visible and radiator is almost full.
6. Replace the cap. Turn until tightly installed. (Cap must be tightly installed to prevent coolant loss.)

After any coolant has been added, check the coolant concentration (refer to *Checking engine coolant*). If the concentration is not 50/50 (protection to  $-34^{\circ}$  F/ $-36^{\circ}$  C), drain some coolant and adjust the concentration. It may take several drains and additions to obtain a 50/50 coolant concentration.

Whenever coolant has been added, the coolant level in the coolant reservoir should be checked the next few times you drive the vehicle. If

## Maintenance and Specifications

necessary, add enough 50/50 concentration of engine coolant and distilled water to bring the liquid level to the proper level.

If you have to add more than 1.0 quart (1.0 liter) of engine coolant per month, have your authorized dealer check the engine cooling system. Your cooling system may have a leak. Operating an engine with a low level of coolant can result in engine overheating and possible engine damage.

### Recycled engine coolant

Ford Motor Company does NOT recommend the use of recycled engine coolant in vehicles originally equipped with Motorcraft Premium Gold Engine Coolant since a Ford-approved recycling process is not yet available.



Used engine coolant should be disposed of in an appropriate manner. Follow your community's regulations and standards for recycling and disposing of automotive fluids.

### Coolant refill capacity

To find out how much fluid your vehicle's cooling system can hold, refer to *Maintenance product specifications and capacities* in this chapter.

Fill your engine coolant reservoir as outlined in *Adding engine coolant* in this section.

### Severe climates

If you drive in extremely cold climates (less than  $-34^{\circ}\text{F}$  [ $-36^{\circ}\text{C}$  ]):

- **It may be necessary to increase the coolant concentration above 50%.**
- **NEVER increase the coolant concentration above 60%.**
- **Increased engine coolant concentrations above 60% will decrease the overheat protection characteristics of the engine coolant and may cause engine damage.**
- **Refer to the chart on the coolant container to ensure the coolant concentration in your vehicle will provide adequate freeze protection at the temperatures in which you drive in the winter months.**

If you drive in extremely hot climates:

- **It is still necessary to maintain the coolant concentration above 40%.**



## Maintenance and Specifications

- **NEVER decrease the coolant concentration below 40%.**
- **Decreased engine coolant concentrations below 40% will decrease the corrosion protection characteristics of the engine coolant and may cause engine damage.**
- **Decreased engine coolant concentrations below 40% will decrease the freeze protection characteristics of the engine coolant and may cause engine damage.**
- **Refer to the chart on the coolant container to ensure the coolant concentration in your vehicle will provide adequate protection at the temperatures in which you drive.**

Vehicles driven year-round in non-extreme climates should use a 50/50 mixture of engine coolant and distilled water for optimum cooling system and engine protection.

### FUEL FILTER

For fuel filter replacement, see your authorized dealer. Refer to *scheduled maintenance information* for the appropriate intervals for changing the fuel filter.

**Replace the fuel filter with an authorized Motorcraft part. The customer warranty may be void for any damage to the fuel system if an authorized Motorcraft fuel filter is not used.**

### WHAT YOU SHOULD KNOW ABOUT AUTOMOTIVE FUELS

#### Important safety precautions



Do not overfill the fuel tank. The pressure in an overfilled tank may cause leakage and lead to fuel spray and fire.



The fuel system may be under pressure. If the fuel filler cap is venting vapor or if you hear a hissing sound, wait until it stops before completely removing the fuel filler cap. Otherwise, fuel may spray out and injure you or others.



If you do not use the proper fuel filler cap, excessive vacuum in the fuel tank may damage the fuel system or cause the fuel cap to disengage in a collision, which may result in possible personal injury.

## Maintenance and Specifications



Automotive fuels can cause serious injury or death if misused or mishandled.



Gasoline may contain benzene, which is a cancer-causing agent.

Observe the following guidelines when handling automotive fuel:

- Extinguish all smoking materials and any open flames before refueling your vehicle.
- Always turn off the vehicle before refueling.
- Automotive fuels can be harmful or fatal if swallowed. Fuel such as gasoline is highly toxic and if swallowed can cause death or permanent injury. If fuel is swallowed, call a physician immediately, even if no symptoms are immediately apparent. The toxic effects of fuel may not be visible for hours.
- Avoid inhaling fuel vapors. Inhaling too much fuel vapor of any kind can lead to eye and respiratory tract irritation. In severe cases, excessive or prolonged breathing of fuel vapor can cause serious illness and permanent injury.
- Avoid getting fuel liquid in your eyes. If fuel is splashed in the eyes, remove contact lenses (if worn), flush with water for 15 minutes and seek medical attention. Failure to seek proper medical attention could lead to permanent injury.
- Fuels can also be harmful if absorbed through the skin. If fuel is splashed on the skin and/or clothing, promptly remove contaminated clothing and wash skin thoroughly with soap and water. Repeated or prolonged skin contact with fuel liquid or vapor causes skin irritation.
- Be particularly careful if you are taking “Antabuse” or other forms of disulfiram for the treatment of alcoholism. Breathing gasoline vapors, or skin contact could cause an adverse reaction. In sensitive individuals, serious personal injury or sickness may result. If fuel is splashed on the skin, promptly wash skin thoroughly with soap and water. Consult a physician immediately if you experience an adverse reaction.



## Maintenance and Specifications



When refueling always shut the engine off and never allow sparks or open flames near the filler neck. Never smoke while refueling. Fuel vapor is extremely hazardous under certain conditions. Care should be taken to avoid inhaling excess fumes.



The flow of fuel through a fuel pump nozzle can produce static electricity, which can cause a fire if fuel is pumped into an ungrounded fuel container.

### Refueling



Fuel vapor burns violently and a fuel fire can cause severe injuries. To help avoid injuries to you and others:

- Read and follow all the instructions on the pump island;
- Turn off your engine when you are refueling;
- Do not smoke if you are near fuel or refueling your vehicle;
- Keep sparks, flames and smoking materials away from fuel;
- Stay outside your vehicle and do not leave the fuel pump unattended when refueling your vehicle — this is against the law in some places;
- Keep children away from the fuel pump; never let children pump fuel.

Use the following guidelines to avoid electrostatic charge build-up when filling an ungrounded fuel container:

- Place approved fuel container on the ground.
- DO NOT fill a fuel container while it is in the vehicle (including the cargo area).
- Keep the fuel pump nozzle in contact with the fuel container while filling.
- DO NOT use a device that would hold the fuel pump handle in the fill position.

### Fuel Filler Cap

Your fuel tank filler cap has an indexed design with a 1/4 turn on/off feature.

When fueling your vehicle:

1. Turn the engine off.

## Maintenance and Specifications

2. Carefully turn the filler cap counterclockwise 1/4 of a turn until it stops.
3. Pull to remove the cap from the fuel filler pipe.
4. To install the cap, align the tabs on the cap with the notches on the filler pipe.
5. Turn the filler cap clockwise 1/4 of a turn until it clicks.

If the “Check Fuel Cap” indicator comes on or if “Service Engine Soon/Check Engine” indicator comes on and stays on when you start the engine, the fuel filler cap may not be properly installed. Turn off the engine, remove the fuel filler cap, align the cap properly and reinstall it.

**If you must replace the fuel filler cap, replace it with a fuel filler cap that is designed for your vehicle. The customer warranty may be void for any damage to the fuel tank or fuel system if the correct genuine Ford or Motorcraft fuel filler cap is not used.**



The fuel system may be under pressure. If the fuel filler cap is venting vapor or if you hear a hissing sound, wait until it stops before completely removing the fuel filler cap. Otherwise, fuel may spray out and injure you or others.



If you do not use the proper fuel filler cap, excessive vacuum in the fuel tank may damage the fuel system or cause the fuel cap to disengage in a collision, which may result in possible personal injury.

FORD RECOMMENDS BP



### Choosing the right fuel

Use only UNLEADED fuel or UNLEADED fuel blended with a maximum of 10% ethyl alcohol. Your vehicle was not designed to run on E85 fuels that are blended with a maximum of 85% ethyl alcohol. The use of

284

## Maintenance and Specifications

leaded fuel is prohibited by law and could damage your vehicle. Do not use fuel containing methanol. It can damage critical fuel system components.

Your vehicle was not designed to use fuel or fuel additives with metallic compounds, including manganese-based additives. Studies indicate that these additives can cause your vehicle's emission control system to deteriorate more rapidly. In Canada, premium grade fuel generally contains more metallic additives than regular grade fuel. We recommend using regular grade fuel. In Canada, many fuels contain metallic additives, but fuels free of such additives may be available; check with your local fuel dealer.

Repairs to correct the effects of using a fuel for which your vehicle was not designed may not be covered by your warranty.

### Octane recommendations

Your vehicle is designed to use "Regular" unleaded gasoline with pump (R+M)/2 octane rating of 87. We do not recommend the use of gasolines labeled as "Regular" that are sold with octane ratings of 86 or lower in high altitude areas.

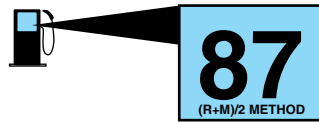

Do not be concerned if your engine sometimes knocks lightly. However, if it knocks heavily under most driving conditions while you are using fuel with the recommended octane rating, see your authorized dealer to prevent any engine damage.

### Fuel quality

If you are experiencing starting, rough idle or hesitation driveability problems, try a different brand of unleaded gasoline. "Premium" unleaded gasoline is not recommended for vehicles designed to use "Regular" unleaded gasoline because it may cause these problems to become more pronounced. If the problems persist, see your authorized dealer.

Do not add aftermarket fuel additive products to your fuel tank. It should not be necessary to add any aftermarket products to your fuel tank if you continue to use high quality fuel of the recommended octane rating. These products have not been approved for your engine and could cause damage to the fuel system. Repairs to correct the effects of using an aftermarket product in your fuel may not be covered by your warranty.

Many of the world's automakers approved the World-wide Fuel Charter that recommends gasoline specifications to provide improved

## Maintenance and Specifications

performance and emission control system protection for your vehicle. Gasolines that meet the World-wide Fuel Charter should be used when available. Ask your fuel supplier about gasolines that meet the World-wide Fuel Charter.

### Cleaner air

Ford endorses the use of reformulated “cleaner-burning” gasolines to improve air quality.

### Running out of fuel

Avoid running out of fuel because this situation may have an adverse effect on powertrain components.

If you have run out of fuel:

- You may need to cycle the ignition from off to on several times after refueling, to allow the fuel system to pump the fuel from the tank to the engine.
- The  indicator may come on. For more information on the “check engine” or the “service engine soon” indicator, refer to *Warning lights and chimes* in the *Instrument Cluster* chapter.

## ESSENTIALS OF GOOD FUEL ECONOMY

### Measuring techniques

Your best source of information about actual fuel economy is you, the driver. You must gather information as accurately and consistently as possible. Fuel expense, frequency of fill-ups or fuel gauge readings are NOT accurate as a measure of fuel economy. We do not recommend taking fuel economy measurements during the first 1,000 miles (1,600 km) of driving (engine break-in period). You will get a more accurate measurement after 2,000 miles-3,000 miles (3,000 km-5,000 km).

### Filling the tank

The advertised fuel capacity of the fuel tank on your vehicle is equal to the rated refill capacity of the fuel tank as listed in the *Maintenance product specifications and capacities* section of this chapter.

The advertised capacity is the amount of the indicated capacity and the empty reserve combined. Indicated capacity is the difference in the amount of fuel in a full tank and a tank when the fuel gauge indicates empty. Empty reserve is the small amount of fuel remaining in the fuel tank after the fuel gauge indicates empty.

286

## Maintenance and Specifications

**The amount of usable fuel in the empty reserve varies and should not be relied upon to increase driving range. When refueling your vehicle after the fuel gauge indicates empty, you might not be able to refuel the full amount of the advertised capacity of the fuel tank due to the empty reserve still present in the tank.**

For consistent results when filling the fuel tank:

- Turn the engine/ignition switch to the off position prior to refueling, an error in the reading will result if the engine is left running.
- Use the same filling rate setting (low — medium — high) each time the tank is filled.
- Allow no more than three automatic click-offs when filling.
- Always use fuel with the recommended octane rating.
- Use a known quality gasoline, preferably a national brand.
- Use the same side of the same pump and have the vehicle facing the same direction each time you fill up.
- Have the vehicle loading and distribution the same every time.

Your results will be most accurate if your filling method is consistent.

### Calculating fuel economy

1. Fill the fuel tank completely and record the initial odometer reading (in miles or kilometers).
2. Each time you fill the tank, record the amount of fuel added (in gallons or liters).
3. After at least three to five tank fill-ups, fill the fuel tank and record the current odometer reading.
4. Subtract your initial odometer reading from the current odometer reading.
5. Follow one of the simple calculations in order to determine fuel economy:

Calculation 1: **Divide total miles traveled by total gallons used.**

Calculation 2: **Multiply liters used by 100, then divide by total kilometers traveled.**

Keep a record for at least one month and record the type of driving (city or highway). This will provide an accurate estimate of the vehicle's fuel economy under current driving conditions. Additionally, keeping records during summer and winter will show how temperature impacts fuel economy. In general, lower temperatures give lower fuel economy.

## Maintenance and Specifications

### Driving style — good driving and fuel economy habits

Give consideration to the lists that follow and you may be able to change a number of variables and improve your fuel economy.

#### **Habits**

- Smooth, moderate operation can yield up to 10% savings in fuel.
- Steady speeds without stopping will usually give the best fuel economy.
- Idling for long periods of time (greater than one minute) may waste fuel.
- Anticipate stopping; slowing down may eliminate the need to stop.
- Sudden or hard accelerations may reduce fuel economy.
- Slow down gradually.
- Driving at reasonable speeds (traveling at 55 mph [88 km/h] uses 15% less fuel than traveling at 65 mph [105 km/h]).
- Revving the engine before turning it off may reduce fuel economy.
- Using the air conditioner or defroster may reduce fuel economy.
- You may want to turn off the speed control in hilly terrain if unnecessary shifting between third and fourth gear occurs. Unnecessary shifting of this type could result in reduced fuel economy.
- Warming up a vehicle on cold mornings is not required and may reduce fuel economy.
- Resting your foot on the brake pedal while driving may reduce fuel economy.
- Combine errands and minimize stop-and-go driving.

#### **Maintenance**

- Keep tires properly inflated and use only recommended size.
- Operating a vehicle with the wheels out of alignment will reduce fuel economy.
- Use recommended engine oil. Refer to *Lubricant specifications* in this chapter.
- Perform all regularly scheduled maintenance items. Follow the recommended maintenance schedule and owner maintenance checks found in *scheduled maintenance information*.

#### **Conditions**

- Heavily loading a vehicle or towing a trailer may reduce fuel economy at any speed.



## Maintenance and Specifications

- Carrying unnecessary weight may reduce fuel economy (approximately 1 mpg [0.4 km/L] is lost for every 400 lb [180 kg] of weight carried).
- Adding certain accessories to your vehicle (for example bug deflectors, rollbars/light bars, running boards, ski/luggage racks) may reduce fuel economy.
- Using fuel blended with alcohol may lower fuel economy.
- Fuel economy may decrease with lower temperatures during the first 8–10 miles (12–16 km) of driving.
- Driving on flat terrain offers improved fuel economy as compared to driving on hilly terrain.
- Transmissions give their best fuel economy when operated in the top cruise gear and with steady pressure on the gas pedal.
- Close windows for high speed driving.

### EPA window sticker

Every new vehicle should have the EPA window sticker. Contact your authorized dealer if the window sticker is not supplied with your vehicle. The EPA window sticker should be your guide for the fuel economy comparisons with other vehicles.

It is important to note the box in the lower left corner of the window sticker. These numbers represent the Range of MPG (L/100 km) expected on the vehicle under optimum conditions. Your fuel economy may vary depending upon the method of operation and conditions.

### EMISSION CONTROL SYSTEM

Your vehicle is equipped with various emission control components and a catalytic converter which will enable your vehicle to comply with applicable exhaust emission standards. To make sure that the catalytic converter and other emission control components continue to work properly:

- Use only the specified fuel listed.
- Avoid running out of fuel.
- Do not turn off the ignition while your vehicle is moving, especially at high speeds.
- Have the items listed in *scheduled maintenance information* performed according to the specified schedule.

The scheduled maintenance items listed in *scheduled maintenance information* are essential to the life and performance of your vehicle and to its emissions system.

## Maintenance and Specifications

If other than Ford, Motorcraft or Ford-authorized parts are used for maintenance replacements or for service of components affecting emission control, such non-Ford parts should be equivalent to genuine Ford Motor Company parts in performance and durability.



Do not park, idle, or drive your vehicle in dry grass or other dry ground cover. The emission system heats up the engine compartment and exhaust system, which can start a fire.

Illumination of the  indicator, charging system warning light or the temperature warning light, fluid leaks, strange odors, smoke or loss of engine power could indicate that the emission control system is not working properly.





Exhaust leaks may result in entry of harmful and potentially lethal fumes into the passenger compartment.

Do not make any unauthorized changes to your vehicle or engine. By law, vehicle owners and anyone who manufactures, repairs, services, sells, leases, trades vehicles, or supervises a fleet of vehicles are not permitted to intentionally remove an emission control device or prevent it from working. Information about your vehicle's emission system is on the Vehicle Emission Control Information Decal located on or near the engine. This decal identifies engine displacement and gives some tune up specifications.

Please consult your *Warranty Guide* for complete emission warranty information.

### On board diagnostics (OBD-II)

Your vehicle is equipped with a computer that monitors the engine's emission control system. This system is commonly known as the On Board Diagnostics System (OBD-II). This OBD-II system protects the environment by ensuring that your vehicle continues to meet government emission standards. The OBD-II system also assists your authorized dealer in properly servicing your vehicle. When the  indicator illuminates, the OBD-II system has detected a malfunction. Temporary malfunctions may cause the  indicator to illuminate. Examples are:

1. The vehicle has run out of fuel—the engine may misfire or run poorly.
2. Poor fuel quality or water in the fuel.

290



## Maintenance and Specifications

3. The fuel cap may not have been securely tightened. See *Fuel filler cap* in this chapter.

These temporary malfunctions can be corrected by filling the fuel tank with good quality fuel and/or properly tightening the fuel cap. After three driving cycles without these or any other temporary malfunctions present, the  indicator should turn off—A driving cycle consists of a cold engine startup followed by mixed city/highway driving. No additional vehicle service is required.

If the  indicator remains on, have your vehicle serviced at the first available opportunity.

### Readiness for Inspection/Maintenance (I/M) testing

In some localities, it may be a legal requirement to pass an I/M test of the on-board diagnostics system. If the  indicator is on, refer to the description in the *Warning lights and chimes* section of the *Instrument Cluster* chapter. Your vehicle may not pass the I/M test with the  indicator on.

If the vehicle's powertrain system or its battery has just been serviced, the on-board diagnostics system is reset to a "not ready for I/M test" condition. To ready the on-board diagnostics system for I/M testing, a minimum of 30 minutes of city and highway driving is necessary as described below:

- First, at least 10 minutes of driving on an expressway or highway.
- Next, at least 20 minutes driving in stop-and-go, city-type traffic with at least four idle periods.

Allow the vehicle to sit for at least eight hours without starting the engine. Then, start the engine and complete the above driving cycle. The engine must warm up to its normal operating temperature. Once started, do not turn off the engine until the above driving cycle is complete.

## Maintenance and Specifications

### POWER STEERING FLUID

Check the power steering fluid. Refer to the scheduled maintenance guide for the service interval schedules. If adding fluid is necessary, use only MERCON® ATF.

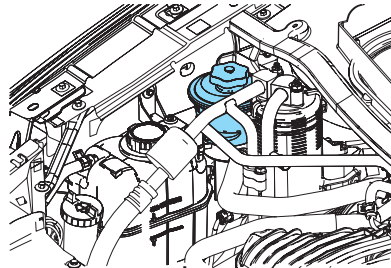

1. Start the engine and let it run until it reaches normal operating temperature (the engine coolant temperature gauge indicator will be near the center of the normal area between H and C).
2. While the engine idles, turn the steering wheel left and right several times.
3. Turn the engine off.
4. Check the fluid level in the reservoir. It should be between the MIN and MAX lines. Do not add fluid if the level is within this range.
5. If the fluid is low, add fluid in small amounts, continuously checking the level until it reaches the correct operating range. Be sure to put the cap back on the reservoir.

### BRAKE FLUID

The fluid level will drop slowly as the brakes wear, and will rise when the brake components are replaced. Fluid levels between the “MIN” and “MAX” lines are within the normal operating range; there is no need to add fluid. If the fluid levels are outside of the normal operating range the performance of your brake system could be compromised; seek service from your authorized dealer immediately.

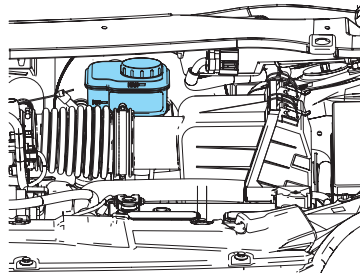

## Maintenance and Specifications

### TRANSMISSION FLUID

#### Checking automatic transmission fluid

Refer to your *scheduled maintenance information* for scheduled intervals for fluid checks and changes. Your transaxle does not consume fluid. However, the fluid level should be checked if the transaxle is not working properly, i.e., if the transaxle slips or shifts slowly or if you notice some sign of fluid leakage.

**Automatic transmission fluid expands when warmed. To obtain an accurate fluid check, drive the vehicle until it is warmed up (approximately 20 miles [30 km]). If your vehicle has been operated for an extended period at high speeds, in city traffic during hot weather or pulling a trailer, the vehicle should be turned off for about 30 minutes to allow fluid to cool before checking.**

1. Drive the vehicle 20 miles (30 km) or until it reaches normal operating temperature.
2. Park the vehicle on a level surface and engage the parking brake.
3. With the parking brake engaged and your foot on the brake pedal, start the engine and move the gearshift lever through all of the gear ranges. Allow sufficient time for each gear to engage.
4. Latch the gearshift lever in P (Park) and leave the engine running.
5. Remove the dipstick, wiping it clean with a clean, dry lint free rag. If necessary, refer to *Identifying components in the engine compartment* in this chapter for the location of the dipstick.
6. Install the dipstick making sure it is fully seated in the filler tube.
7. Remove the dipstick and inspect the fluid level. The fluid should be in the designated areas for normal operating temperature.

#### Low fluid level

Do not drive the vehicle if the fluid level is at the bottom of the dipstick and the outside temperatures are above 50°F (10°C).



#### Correct fluid level

The transmission fluid should be checked at normal operating temperatures 150°F-170°F (66°C-77°C) on a level surface. The normal operating temperature can be reached after approximately 20 miles (30 km) of driving.

## Maintenance and Specifications

The transmission fluid should be in this range if at normal operating temperature (150°F-170°F [66°C-77°C]).



### High fluid level

Fluid levels above the safe range may result in transaxle failure. An overfill condition of transmission fluid may cause shift and/or engagement concerns and/or possible damage.



High fluid levels can be caused by an overheating condition.

### Adjusting automatic transmission fluid levels

Before adding any fluid, make sure the correct type is used. The type of fluid used is normally indicated on the dipstick. Refer to *Maintenance product specifications and capacities* in this chapter.

### Use of a non-approved automatic transmission fluid may cause internal transaxle component damage.

If necessary, add fluid in 1/2 pint (250 mL) increments through the filler tube until the level is correct.

If an overfill occurs, excess fluid should be removed by a qualified technician.



### An overfill condition of transmission fluid may cause shift and/or engagement concerns and/or possible damage.

Do not use supplemental transmission fluid additives, treatments or cleaning agents. The use of these materials may affect transmission operation and result in damage to internal transmission components.

## AIR FILTER

Refer to *scheduled maintenance information* for the appropriate intervals for changing the air filter element.

When changing the air filter element, use only the Motorcraft air filter element listed. Refer to *Motorcraft part numbers* in this chapter.



To reduce the risk of vehicle damage and/or personal burn injuries do not start your engine with the air cleaner removed and do not remove it while the engine is running.

## Maintenance and Specifications

1. Disconnect the Mass Air Flow Sensor electrical connector from the air outlet tube.

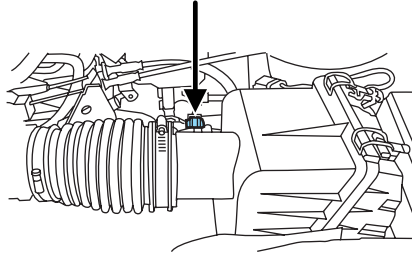

Reposition the locking clip (on the connector) and squeeze connector to remove.

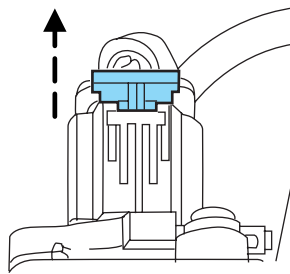

2. Loosen the hose clamp located closest to the air cleaner.

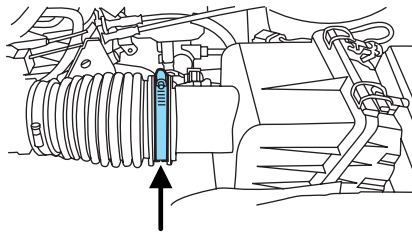

## Maintenance and Specifications

3. Remove the air cleaner assembly from the vehicle.

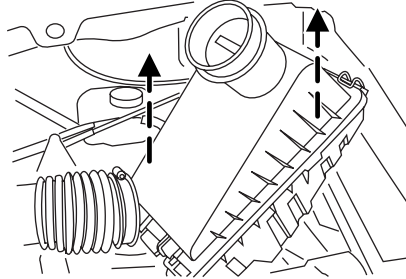

4. Release the two clamps that secure the cover to the air filter housing and place the cover aside.

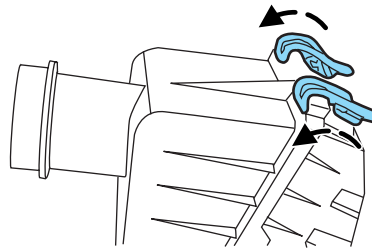

5. Remove the air filter element from the air filter housing.

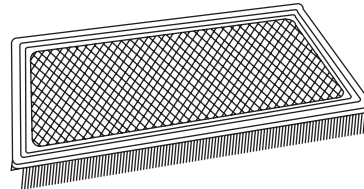

6. Wipe the air filter housing and cover clean to remove any dirt or debris and to ensure good sealing.

7. Install a new air filter element. Be careful not to crimp the filter element edges between the air filter housing and cover.



## Maintenance and Specifications

8. Replace the air filter housing cover and secure the clamps. Be sure all the tabs on the bottom edge are properly aligned.

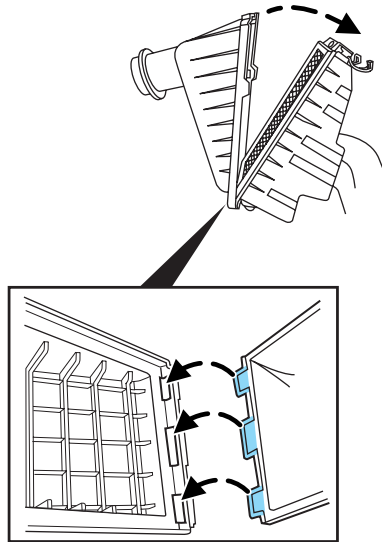

9. Reinstall the air cleaner assembly into the vehicle. Ensure the tabs on the inlet tube are secure in the sheet metal.

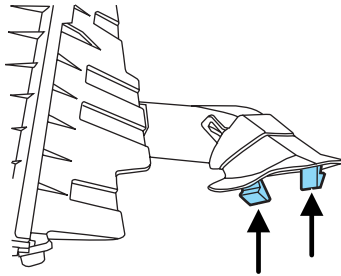

## Maintenance and Specifications

10. Ensure the pads on the bottom of the air cleaner assembly are properly seated.

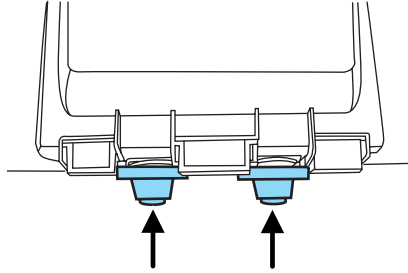

11. Reconnect the outlet tube to the air cleaner assembly and tighten the clamp.

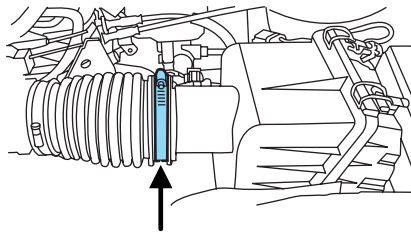

12. Reconnect the Mass Air Flow Sensor electrical connector to the outlet tube. Make sure the locking tab on the connector is in “locked” position.

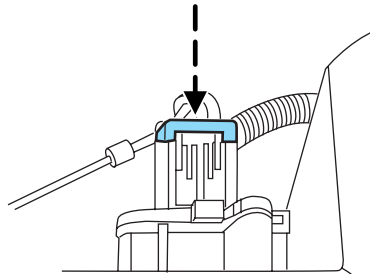

**Note:** If hose clamp is not secured properly or Mass Air Flow Sensor electrical connector is not properly installed the Check Engine light will illuminate when vehicle is operated.

**Note:** Do not use oil-impregnated air filter elements. Failure to use the correct air filter element may result in severe engine damage. The customer warranty may be voided for any damage to the engine if the correct air filter element is not used.

## Maintenance and Specifications

### MOTORCRAFT PART NUMBERS

Component	3.9L OHV V6 engine	4.2L OHV V6 engine
Air filter element	FA-1679	FA-1679
Battery	BXT-59	BXT-59
	BXT-65-750	BXT-65-750
Fuel filter	FG-986B	FG-986B
Oil filter	FL-400S	FL-400S
PCV valve	<sup>1</sup>	
Spark plugs	<sup>2</sup>	

<sup>1</sup>The PCV valve is a critical emission component. It is one of the items listed in *scheduled maintenance information* and is essential to the life and performance of your vehicle and to its emissions system.

For PCV valve replacement, see your authorized dealer. Refer to *scheduled maintenance information* for the appropriate intervals for changing the PCV valve.

**Replace the PCV valve with one that meets Ford material and design specifications for your vehicle, such as a Motorcraft or equivalent replacement part. The customer warranty may be void for any damage to the emissions system if such a PCV valve is not used.**

<sup>2</sup>For spark plug replacement, see your authorized dealer. Refer to the *scheduled maintenance information* for the appropriate intervals for changing the spark plugs.

**Replace the spark plugs with ones that meet Ford material and design specifications for your vehicle, such as Motorcraft or equivalent replacement parts. The customer warranty may be void for any damage to the engine if such spark plugs are not used.**

## Maintenance and Specifications

### MAINTENANCE PRODUCT SPECIFICATIONS AND CAPACITIES

Item	Capacity	Ford part name	Ford part number / Ford specification
Brake fluid	Fill to MAX line on reservoir	Motorcraft High Performance DOT 3 Motor Vehicle Brake Fluid <sup>1</sup>	PM-1 or PM-1-C / ESA-M6C25-A or WSS-M6C62-A
Door weatherstrips	—	Silicone Spray Lubricant	XL-6 / ESR-M13P4-A
Engine coolant without rear heater	14.8 quarts (14.0L)	Motorcraft Premium Gold Engine Coolant (yellow colored) <sup>3</sup>	VC-7-B / WSS-M97B51-A1
Engine coolant with rear heater	15.9 quarts (15.0L)		
Cooling system stop leak pellets	—	Motorcraft Cooling System Stop Leak Pellets	VC-6 / WSS-M99B37-B6
Engine oil	5.0 quarts (4.7L)	Motorcraft SAE 5W-20 Premium Synthetic Blend Motor Oil (US) Motorcraft SAE 5W-20 Super Premium Motor Oil (Canada) <sup>4</sup>	XO-5W20-QSP (US) CXO-5W20-LSP12 (Canada) / WSS-M2C930-A with API Certification Mark
Door latch, hood latch, auxiliary hood latch, door and liftgate hinges, striker plates, seat tracks, sliding door both sides (upper and lower track) and fuel filler door hinge.	—	Multi-Purpose Grease	XG-4 or XL-5 / ESB-M1C93-B

## Maintenance and Specifications

Item	Capacity	Ford part name	Ford part number / Ford specification
Lock cylinders	—	Motorcraft Penetrating and Lock Lubricant	XL-1 / None
Power steering fluid	Fill to line on reservoir	Motorcraft MERCON® ATF	XT-2-QDX / MERCON®
Automatic transaxle fluid	13.3 quarts (12.6L)	Motorcraft MERCON®V ATF <sup>2</sup>	XT-5-QM / MERCON®V
Windshield washer fluid	Fill to line on reservoir	Motorcraft Premium Windshield Washer Concentrate	ZC-32-A / WSB-M8B16-A2
Fuel tank	26.0 gallons (98.4L)	—	—

<sup>1</sup>Use only brake fluids certified to meet Ford specifications. DOT 3 fluid is recommended. However, if DOT 3 is not available, DOT 4 fluid can be used.

<sup>2</sup>Ensure the correct automatic transmission fluid is used MERCON® and MERCON®V are not interchangeable. DO NOT MIX MERCON® and MERCON®V. Refer to *scheduled maintenance information* to determine the correct service interval.

<sup>3</sup>Add the coolant type originally equipped in your vehicle.

<sup>4</sup>Use of synthetic or synthetic blend motor oil is not mandatory. Engine oil need only meet the requirements of Ford specification WSS-M2C930-A and the API Certification mark.

## Maintenance and Specifications

### ENGINE DATA

Engine	3.9 L OHV V6 engine	4.2L OHV V6 engine
Cubic inches	232	256
Required fuel	87 octane	87 octane
Firing order	1-4-2-5-3-6	1-4-2-5-3-6
Ignition system	EDIS	EDIS
Spark plug gap	0.052–0.056 inch (1.32–1.42mm)	0.052–0.056 inch (1.32–1.42mm)
Compression ratio	9.36:1	9.27:1

### Engine drivebelt routing

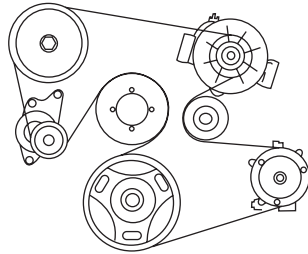

- 3.9L V6 and 4.2L V6 Engines

## Maintenance and Specifications

### IDENTIFYING YOUR VEHICLE

#### Safety Compliance Certification Label

The National Highway Traffic Safety Administration Regulations require that a Safety Compliance Certification Label be affixed to a vehicle and prescribe where the Safety Compliance Certification Label may be located. The Safety Compliance Certification Label is located on the structure (B-Pillar) by the trailing edge of the driver's door or the edge of the driver's door.

MFD. BY FORD MOTOR CO.				
DATE: XX/XX	GVWR: XXXXLB/ XXXXKG			
FRONT GAWR: XXXXL	REAR GAWR: XXXXLB			
XXXXKG	WITH	XXXXKG	WITH	
XXXX/XXXXXX	TIRES	XXXX/XXXXXX	TIRES	
XXXX.XX	RIMS	XXXX.XX	RIMS	
AT XXX kPa/XX	PSI COLD	AT XXX kPa/XX	PSI COLD	
THIS VEHICLE CONFORMS TO ALL APPLICABLE FEDERAL MOTOR VEHICLE SAFETY AND THEFT PREVENTION STANDARDS IN EFFECT ON THE DATE OF MANUFACTURE SHOWN ABOVE.				
VIN: XXXXXXXXXXXXXXXXX	XXXXX XXXXX			
TYPE: XXX				
				
EXT PNT: XX	RC: XX	DSO:		
WB <sup>1</sup> BRK <sup>2</sup>	INT TR <sup>3</sup>	P/PS <sup>4</sup>	R <sup>5</sup> AXLE <sup>6</sup> TR <sup>7</sup> SPR <sup>8</sup>	XXXXX
XXX X	XX	X	XX X XX	XXX
XXXXXXXXXXXXX XXX XXXX-XXXXXX-XX				

#### Vehicle identification number (VIN)

The vehicle identification number is attached to a metal tag and is located on the driver side instrument panel.

Please note that in the graphic, XXXX is representative of your vehicle identification number.

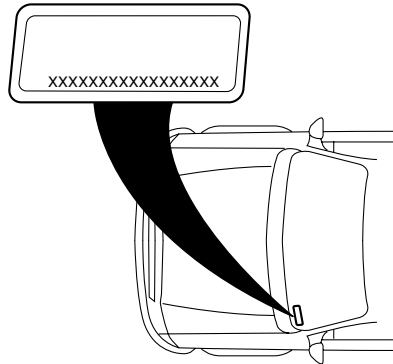

## Maintenance and Specifications

The Vehicle Identification Number (VIN) contains the following information:

1. World manufacturer identifier
2. Brake system / Gross Vehicle Weight Rating (GVWR) / Restraint System
3. Vehicle line, series, body type
4. Engine type
5. Check digit
6. Model year
7. Assembly plant
8. Production sequence number

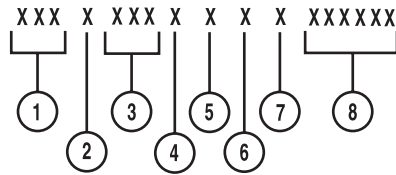

### TRANSMISSION/TRANSAXLE CODE DESIGNATIONS

You can find a transmission/transaxle code on the Safety Compliance Certification Label. The following table tells you which transmission or transaxle each code represents.

**MFD. BY FORD MOTOR CO.**

DATE: XX/XX      GVWR: XXXXLB/ XXXXKG  
 FRONT GAWR: XXXL      REAR GAWR: XXXLB  
 XXXXKG      WITH      XXXXKG      WITH  
 XXXX/XXXXXXXXX      TIRES:      XXXX/XXXXXXXXX      TIRES  
 XXXX.XX      RIMS:      XXXX.XX      RIMS  
 AT      XXX kPa/XX PSI COLD      AT      XXX kPa/XX PSI COLD

THIS VEHICLE CONFORMS TO ALL APPLICABLE FEDERAL MOTOR VEHICLE SAFETY AND THEFT PREVENTION STANDARDS IN EFFECT ON THE DATE OF MANUFACTURE SHOWN ABOVE.

VIN: XXXXXXXXXXXXXXXXX      XXXXX  
 TYPE: XXX      XXXXX

EXT PNT: XX      RC: XX      DSO:      XXXXX  
 WB<sup>1</sup> BRK<sup>1</sup> INT TR<sup>1</sup> TP/PS<sup>1</sup> R<sup>1</sup> AXLE<sup>1</sup> TR<sup>1</sup> SPR<sup>1</sup> XXXXX  
 XXX X      XX      X      XX      X XX      XXX

XXXXXXXXXXXXXX XX XXXX-XXXXXX-XX

Description	Code
Four-speed automatic (4F50N)	N



## Accessories

### **GENUINE FORD ACCESSORIES FOR YOUR VEHICLE**

A wide selection of Genuine Ford Accessories are available for your vehicle through your local Ford or Ford of Canada dealer. These quality accessories have been specifically engineered to fulfill your automotive needs; they are custom designed to complement the style and aerodynamic appearance of your vehicle. In addition, each accessory is made from high quality materials and meets or exceeds Ford's rigorous engineering and safety specifications. Ford Motor Company will repair or replace any properly dealer-installed Genuine Ford Accessories found to be defective in factory-supplied materials or workmanship during the warranty period, as well as any component damaged by the defective accessory. The accessories will be warranted for whichever provides you the greatest benefit:

- 12 months or 12,000 miles (20,000 km) (whichever occurs first), or
- the remainder of your new vehicle limited warranty.

This means that Genuine Ford Accessories purchased along with your new vehicle and installed by a dealer are covered for the full length of your New Vehicle's Limited Warranty — 3 years or 36,000 miles (60,000 km) (whichever occurs first). Contact your dealer for details and a copy of the warranty.

### **Not all accessories are available for all models.**

The following is a list of several Genuine Ford Accessories. Not all accessories are available for all models. For a complete listing of the accessories that are available for your vehicle, please contact your dealer or visit our online store at: [www.fordaccessoriesstore.com](http://www.fordaccessoriesstore.com).

#### **Exterior style**

Bug shields  
Deflectors  
Headlamps, fog lights and Daytime Running Lamps (DRLs)  
Splash guards

#### **Interior style**

Consoles  
Electrochromatic compass/temperature interior mirrors  
Floor mats

#### **Lifestyle**

Ash cup / smoker's package  
Cargo organization and management

## Accessories

### Peace of mind

Mobile-Ease<sup>™</sup> hands-free communication system

Remote start

Vehicle security systems

Wheel locks

For maximum vehicle performance, keep the following information in mind when adding accessories or equipment to your vehicle:

- When adding accessories, equipment, passengers and luggage to your vehicle, do not exceed the total weight capacity of the vehicle or of the front or rear axle (GVWR or GAWR as indicated on the Safety Compliance Certification label). Consult your authorized dealer for specific weight information.
- The Federal Communications Commission (FCC) and Canadian Radio Telecommunications Commission (CRTC) regulate the use of mobile communications systems — such as two-way radios, telephones and theft alarms - that are equipped with radio transmitters. Any such equipment installed in your vehicle should comply with FCC or CRTC regulations and should be installed only by a qualified service technician.
- Mobile communications systems may harm the operation of your vehicle, particularly if they are not properly designed for automotive use.
- To avoid interference with other vehicle functions, such as anti-lock braking systems, amateur radio users who install radios and antennas onto their vehicle should not locate the Amateur Radio Antennas in the area of the driver's side hood.
- Electrical or electronic accessories or components that are added to the vehicle by the authorized dealer or the owner may adversely affect battery performance and durability.

## Index

### A

Accessory delay .....68  
AdvanceTrac .....216  
Air cleaner filter .....294, 299  
Air filter, cabin .....44  
Airbag supplemental restraint system .....153, 162, 164  
    and child safety seats .....155  
    description .....153, 162, 164  
    disposal .....167  
    driver airbag .....155, 163, 165  
    indicator light .....161, 167  
    operation .....155, 163, 165  
    passenger airbag .....155, 163, 165  
    side airbag .....162  
Antifreeze  
    (see Engine coolant) .....276  
Anti-lock brake system  
    (see Brakes) .....214–215  
Anti-theft system .....109, 111  
    arming the system .....111  
    disarming a triggered system .....112  
Audio system  
    (see Radio) .....19, 21, 24, 27  
Automatic transaxle .....219  
    fluid, adding .....293  
    fluid, checking .....293  
    fluid, refill capacities .....300  
    fluid, specification .....300  
Automatic transmission  
    driving an automatic overdrive .....221  
Auxiliary power point .....66

### B

Battery .....274

acid, treating emergencies .....274  
battery saver .....47  
    jumping a disabled battery .....245  
    maintenance-free .....274  
    replacement, specifications .....299  
    servicing .....274  
BeltMinder® .....148  
Brakes .....214  
    anti-lock .....214–215  
    anti-lock brake system (ABS) warning light .....215  
    fluid, checking and adding .....292  
    fluid, refill capacities .....300  
    fluid, specifications .....300  
    lubricant specifications .....300  
    parking .....216  
    shift interlock .....219  
Bulbs .....51

### C

Capacities for refilling fluids .....300  
Cargo net .....91  
Cassette tape player .....19, 21, 24  
Cell phone use .....7  
Child safety restraints .....168  
    child safety belts .....168  
Child safety seats .....171  
    in front seat .....173  
    in rear seat .....173  
    tether anchorage hardware .....175  
Cleaning your vehicle  
    engine compartment .....262  
    instrument panel .....263  
    interior .....264  
    interior trim .....264  
    plastic parts .....262  
    washing .....260  
    waxing .....261

## Index

- wheels .....261
- wiper blades .....263
- Clock .....66
- Compass, electronic .....58
  - calibration .....60
  - set zone adjustment .....59
- Console .....65
  - overhead .....58
- Controls
  - power seat .....115
  - steering column .....74
- Coolant
  - checking and adding .....276
  - refill capacities .....280, 300
  - specifications .....300
- Cruise control  
(see Speed control) .....71
- Cupholder(s) .....118
- Customer Assistance .....225
  - Ford Extended Service Plan .....257
  - Getting assistance outside the U.S. and Canada .....258
  - Getting roadside assistance ...225
  - Getting the service you need .....253
  - Ordering additional owner's literature .....258
  - Utilizing the Mediation/Arbitration Program .....256
- D**
- Daytime running lamps  
(see Lamps) .....46
- Dipstick
  - automatic transmission fluid .....293
  - engine oil .....271
- Doors .....60
  - power sliding .....62
- Driving under special conditions .....222
  - through water .....224
- DVD system .....34
- E**
- Emergencies, roadside
  - jump-starting .....245
- Emission control system .....289
- Engine .....302
  - cleaning .....262
  - coolant .....276
  - idle speed control .....274
  - lubrication specifications .....300
  - refill capacities .....300
  - service points .....269–270
  - starting after a collision .....227
- Engine block heater .....214
- Engine oil .....271
  - change oil soon warning, message center .....271
  - checking and adding .....271
  - dipstick .....271
  - filter, specifications .....273, 299
  - recommendations .....273
  - refill capacities .....300
  - specifications .....300
- Exhaust fumes .....213
- F**
- Floor mats .....87
- Fluid capacities .....300
- Fuel .....281
  - calculating fuel economy .....286
  - cap .....283

308

## Index

- capacity .....300
- choosing the right fuel .....284
- comparisons with EPA fuel
- economy estimates .....289
- detergent in fuel .....286
- filling your vehicle
- with fuel .....281, 283, 286
- filter, specifications .....281, 299
- fuel pump shut-off switch .....227
- improving fuel economy .....286
- octane rating .....285, 302
- quality .....285
- running out of fuel .....286
- safety information relating
- to automotive fuels .....281
- Fuses .....227–228
- G**
- Gas cap (see Fuel cap) .....283
- Gas mileage
- (see Fuel economy) .....286
- Gauges .....16
- H**
- Hazard flashers .....226
- Head restraints .....113, 117
- Headlamps .....45
- aiming .....48
- autolamp system .....45
- bulb specifications .....51
- daytime running lights .....46
- flash to pass .....46
- high beam .....46
- replacing bulbs .....52
- turning on and off .....45
- Heating
- heating and air conditioning
- system .....35–36
- Homelink wireless control
- system .....74
- Hood .....268
- I**
- Ignition .....211, 302
- Illuminated visor mirror .....57
- Infant seats
- (see Safety seats) .....171
- Inspection/maintenance
- (I/M) testing .....291
- Instrument panel .....65
- cleaning .....263
- cluster .....10
- lighting up panel and
- interior .....47
- J**
- Jump-starting your vehicle .....245
- K**
- Keyless entry system .....106
- autolock .....96
- keypad .....107
- locking and unlocking
- doors .....108
- programming entry code .....107
- Keys .....95, 109–110
- positions of the ignition .....211
- L**
- Lamps
- autolamp system .....45
- bulb replacement
- specifications chart .....51
- daytime running light .....46

## Index

- headlamps .....45
- headlamps, flash to pass .....46
- instrument panel, dimming .....47
- interior lamps .....49–51
- replacing bulbs .....52, 55
- Lane change indicator  
(see Turn signal) .....49
- Liftgate .....87–88, 92
- remote release .....95, 101
- Lights, warning and indicator ....10
- anti-lock brakes (ABS) .....215
- Load limits .....200
- Locks
- autolock .....96
- childproof .....98
- doors .....95
- Lubricant specifications .....300
- Lug nuts .....245
- Luggage rack .....92
- Lumbar support, seats .....115
- M**
- Message center .....78–79
- english/metric button .....81
- system check button .....81
- warning messages .....82
- Mirrors .....69
- automatic dimming rearview
- mirror .....69
- fold away .....70
- heated .....70
- programmable memory .....102
- side view mirrors (power) .....69
- signal .....70
- Motorcraft parts .....265, 281, 299
- O**
- Octane rating .....285
- Oil (see Engine oil) .....271
- Overdrive .....220
- P**
- Parking brake .....216
- Parts (see Motorcraft parts) ....299
- Passenger Occupant  
Classification Sensor .....139
- Pedals (see Power  
adjustable foot pedals) .....71
- Power adjustable foot pedals .....71
- Power distribution box  
(see Fuses) .....231
- Power door locks .....95–96
- Power liftgate .....88, 101
- Power mirrors .....69
- Power point .....66
- Power steering .....218
- fluid, checking and adding ....292
- fluid, refill capacity .....300
- fluid, specifications .....300
- Power Windows .....67
- R**
- Radio .....19, 21, 24, 27
- Relays .....227
- Remote entry system .....98, 100
- illuminated entry .....104–105
- locking/unlocking
- doors .....100–101
- panic alarm .....102
- replacement/additional
- transmitters .....103
- replacing the batteries .....103
- Reverse sensing system .....222

## Index

- Roadside assistance .....225  
Roof rack .....92
- S**
- Safety Belt Maintenance .....147  
Safety belts (see Safety restraints) .....138, 141, 143–145  
Safety Canopy .....164  
Safety defects, reporting .....259  
Safety  
restraints .....138, 141, 143–145  
  BeltMinder® .....148  
  extension assembly .....146  
  for adults .....143–145  
  for children .....167–168  
  Occupant Classification  
  Sensor .....139  
  safety belt maintenance .....147  
  warning light and chime .....148  
Safety seats for children .....171  
Safety Compliance  
Certification Label .....303  
Seat belts  
(see Safety restraints) .....138  
Seats .....113  
  child safety seats .....171  
  front seats .....113–116  
  memory seat .....102, 117  
  second row  
  seats .....119–120, 123–124  
  third row  
  seats .....124, 131, 135–137  
SecuriLock passive  
anti-theft system .....109–110  
Servicing your vehicle .....267  
Spare tire (see Changing the Tire) .....238  
Spark plugs,  
specifications .....299, 302  
Specification chart,  
lubricants .....300  
Speed control .....71  
Starting your vehicle .....211–213  
  jump starting .....245  
Steering wheel  
  controls .....74  
  tilting .....57
- T**
- Tilt steering wheel .....57  
Tire Pressure Monitoring  
System (TPMS)  
  Tires, Wheels and Loading ....196  
  Warning Displays .....10  
Tires .....182–183  
  alignment .....190  
  care .....186  
  changing .....238, 240  
  checking the pressure .....186  
  inflating .....184  
  label .....195  
  replacing .....188  
  rotating .....190  
  safety practices .....189  
  sidewall information .....191  
  snow tires and chains .....200  
  spare tire .....236  
  terminology .....183  
  tire grades .....183  
  treadwear .....182, 187  
Towing .....206  
  recreational towing .....210  
  trailer towing .....206  
  wrecker .....251  
Transaxle  
  automatic operation .....219

## Index

- fluid, refill capacities .....300
- lubricant specifications .....300
- Transmission
  - brake-shift interlock (BSI) ....219
  - fluid, checking and adding (automatic) .....293
- Turn signal .....49
- V**
- Vehicle Identification Number (VIN) .....303
- Vehicle loading .....200
- Ventilating your vehicle .....214
- W**
- Warning lights (see Lights) .....10
- Washer fluid .....270
- Water, Driving through .....224
- Windows
  - power .....67
  - rear wiper/washer .....56
- Windshield washer fluid and wipers .....56
  - checking and adding fluid ....270
  - liftgate reservoir .....270
  - replacing wiper blades .....271
- Wrecker towing .....251