

Owner's Manual

Important!
Return your Warranty Registration
Card within 10 days. See why.

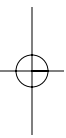

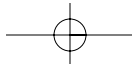

Return your Warranty Registration card today to ensure you receive all the benefits you're entitled to.

Once your PHILIPS MAGNAVOX purchase is registered, you're eligible to receive all the privileges of owning a PHILIPS MAGNAVOX product. So complete and return the Warranty Registration Card enclosed with your purchase at once. And take advantage of these important benefits.

Warranty Verification

Registering your product within 10 days confirms your right to maximum protection under the terms and conditions of your PHILIPS MAGNAVOX warranty.

Owner Confirmation

Your completed Warranty Registration Card serves as verification of ownership in the event of product theft or loss.

Model Registration

Returning your Warranty Registration Card right away guarantees you'll receive all the information and special offers which you qualify for as the owner of your model.

PHILIPS MAGNAVOX

Congratulations on your purchase, and welcome to the "family!"



Dear PHILIPS MAGNAVOX product owner:

Thank you for your confidence in PHILIPS MAGNAVOX. You've selected one of the best-built, best-backed products available today. And we'll do everything in our power to keep you happy with your purchase for many years to come.

As a member of the PHILIPS MAGNAVOX "family," you're entitled to protection by one of the most comprehensive warranties and outstanding service networks in the industry.

What's more, your purchase guarantees you'll receive all the information and special offers for which you qualify, plus easy access to accessories from our convenient home shopping network.

And most importantly you can count on our uncompromising commitment to your total satisfaction.

All of this is our way of saying welcome-and thanks for investing in a PHILIPS MAGNAVOX product.

Sincerely,



Robert Minkhorst
President and Chief Executive Officer

P.S. Remember, to get the most from your PHILIPS MAGNAVOX product, you must return your Warranty Registration Card within 10 days. So please mail it to us right now!

Know these

safety symbols



⚡ This "bolt of lightning" indicates uninsulated material within your unit may cause an electrical shock. For the safety of everyone in your household, please do not remove product covering.

⚠ The "exclamation point" calls attention to features for which you should read the enclosed literature closely to prevent operating and maintenance problems.

WARNING: TO PREVENT FIRE OR SHOCK HAZARD, DO NOT EXPOSE THIS EQUIPMENT TO RAIN OR MOISTURE.

CAUTION: To prevent electric shock, match wide blade of plug to wide slot, and fully insert.

ATTENTION: Pour éviter les chocs électriques, introduire la lame la plus large de la fiche dans la borne correspondante de la prise et pousser jusqu'au fond.

For Customer Use

Enter below the Serial No. which is located on the rear of the cabinet. Retain this information for future reference.

Model No. _____
Serial No. _____

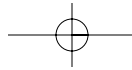

Introduction 3

Welcome to your VCR owner's manual.

This manual describes the VRZ344 and the VRZ364. The VRZ344 is a monaural (single sound source) system, while the VRZ364 is a stereo system. Otherwise, the two models are exactly the same. In this manual, the VRZ364 is illustrated. (The VRZ344 has single AUDIO IN/OUT Jacks. Otherwise, the VRZ344 looks exactly like the VRZ364.)

This manual has six sections: Setting Up Your VCR; Description of Controls; Basic Operations; Recording; Playing; and Information You May Need. The instructions explain all of the VCR's features, which are listed below.

Features

- Automatic Channel Setup
- Automatic Clock Setting
- Automatic Head Cleaner
- Daylight-Saving Time
- Hi-Fi Stereo Tape Playback (VRZ364 only)
- Index Search
- Multi-Channel Television Sound (MTS) System (VRZ364 only)
- 19 Micron Head
- On-Screen Menus in English, Spanish, or French
- Quick Programming
- Remote Control with Capability to Operate TV, Cable Box, and Direct Broadcast System (DBS)
- Repeat Play
- Skip Search
- VCR Plus+ Programming System

Safety Precautions

Warning: To prevent fire or shock hazard, do not expose this equipment to rain or moisture.

FCC Warning: Any unauthorized changes or modifications to this equipment void the user's authority to operate it.

This VCR, equipped with a High Quality (HQ) System, is compatible with existing Video Home System (VHS) equipment. This VCR is also equipped with S-VHS Quasi Playback (SQPB), allowing you to play S-VHS recordings with regular VHS resolution. However, you may not record on S-VHS tapes with this VCR.

This product has a 19 micron head which provides a better picture when you view tapes recorded in slow speed (SLP).

Philips Consumer Electronics Company recommends that you use only video cassette tapes that have been tested and inspected for use in two, four, six, and eight hour VCRs, and which are labeled with the **VHS** mark. The use of tapes that have not been inspected for use in two, four, six, and eight hour VCRs may result in poor picture quality and excessive deposits on the video heads, which may not be covered by the warranty if damage occurs.

Note to the Cable TV System Installer: This reminder is provided to call the Cable TV system installer's attention to Article 820-40 of the National Electrical Code, which provides guidelines for proper grounding – in particular, specifying that the cable ground shall be connected to the grounding system of the building, as close to the point of cable entry as possible.

Operation is subject to the following two conditions: (1) this device may not cause interference, and (2) this device must accept any interference, including interference that may cause undesired operation of the device.



Copyright 1998 Philips Consumer Electronics Company. All rights reserved.

VCR Plus+ and PlusCode are trademarks of Gemstar Development Corporation. The VCR Plus+ system is manufactured under license from Gemstar Development Corporation.



The ENERGY STAR® name and logo are registered marks of the U.S. Environmental Protection Agency. As an ENERGY STAR® Partner, Philips Consumer Electronics Company has determined that this product or product model meets the ENERGY STAR® guidelines for energy efficiency.

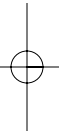
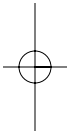

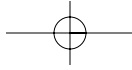

4 Table of Contents

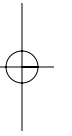
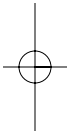



Before Using Your VCR 5

Removing the Plastic Cover from the Front Panel

A thin, plastic cover may protect the front panel of your VCR. Before using the VCR, lift a corner of the plastic, then peel it off.

Putting Batteries in the Remote Control

1

To open the battery compartment, push in the tab, then pull up the lid.

2

Place two AA batteries inside the battery compartment with their + and - ends aligned as indicated.

3

Close the battery compartment lid.

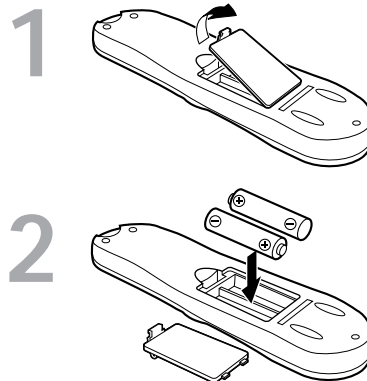

Using the Remote Control

- Do not put objects between the remote control and the VCR.
- Press the VCR button, then point the remote control at the VCR's remote sensor, before pressing other VCR operation buttons.
- Press the TV button, then point the remote control at the TV, before pressing other TV operation buttons.
- Press the CBL/DBS button, then point the remote control at the Cable Box/DBS, before pressing other Cable Box/DBS operation buttons.

Erase Protection

Video cassettes have record tabs to ensure that recordings are not erased accidentally.

1

To prevent accidental erasure, break off the tab with a screwdriver.

2

To record again, cover the hole with cellophane tape.

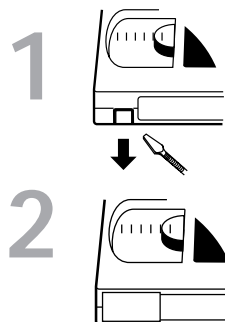

VCR Maintenance

- Remove any light adhesive stick-on notes from the video cassette before putting the cassette in the VCR. Removable labels can jam the VCR.
- Periodic maintenance is required to maintain your VCR's performance. Your VCR has an automatic head cleaner, but the video heads will eventually require cleaning or replacement. Cleaning or replacement of the video heads should be performed only by an authorized service center.

Helpful Hints

- The remote control and its batteries are supplied.
- Do not mix alkaline and manganese batteries.
- Do not mix old and new batteries.

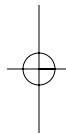
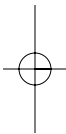

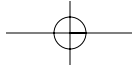

6 Hookups Without a Cable Box

The basic VCR/TV connection – antenna/cable to VCR to TV – is shown below. If you have a Cable Box or a Direct Broadcast System, please refer to pages 8 - 9. After you hook up the VCR, please go to page 10 to turn on the VCR. (The VRZ364 is illustrated here. The VRZ344 has single AUDIO IN/OUT Jacks.)

1

Disconnect the antenna or cable from your TV.

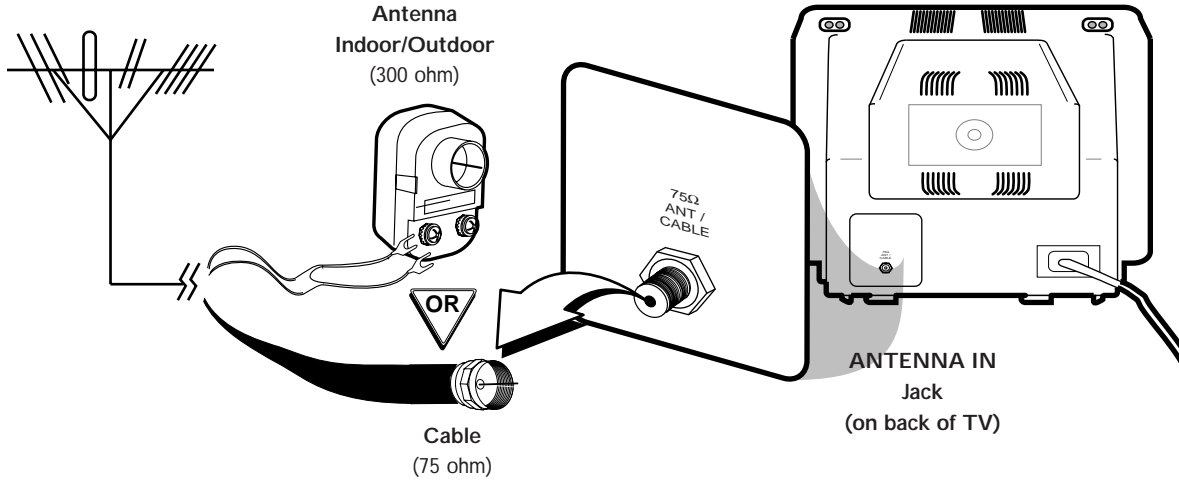

2

Connect the antenna or cable to the ANT(enna) IN Jack on the back of the VCR.

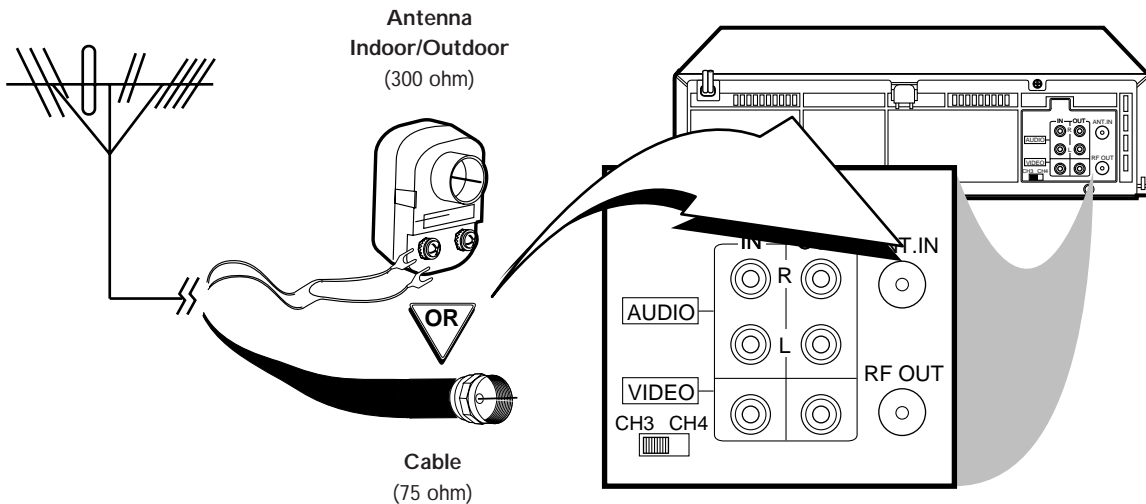

Hookups Without a Cable Box (cont'd) 7

3

Connect the RF coaxial cable (supplied) to the RF OUT Jack on the back of the VCR and to the ANTENNA IN Jack on the TV. (You may use either a snap-on type or screw-on type of coaxial cable, whichever you prefer. A snap-on type is supplied.)

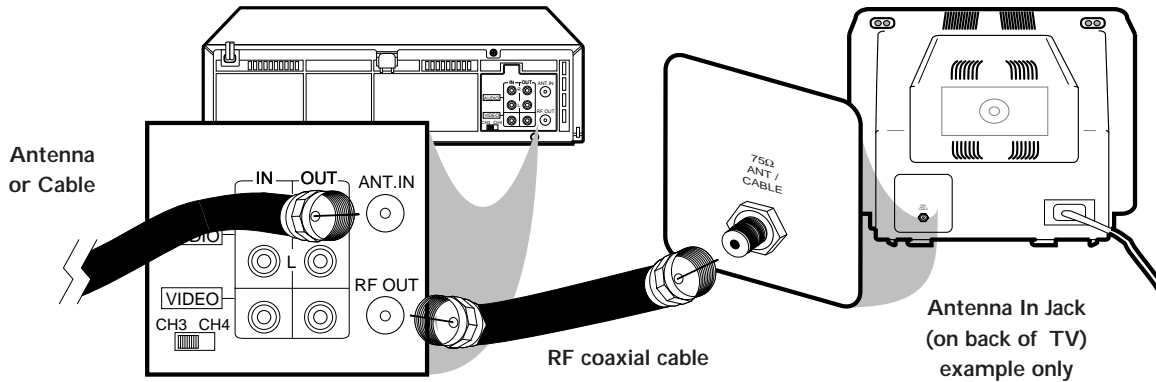

4

Plug in the TV and the VCR.

5

Set the CH3/CH4 switch on the back of the VCR to CH3 or CH4, whichever channel is not used or least used in your area. To operate your VCR with your TV, set the TV to the same channel. For example, when playing a tape, if the CH3/CH4 switch is set to CH3, the TV should be on channel 3.

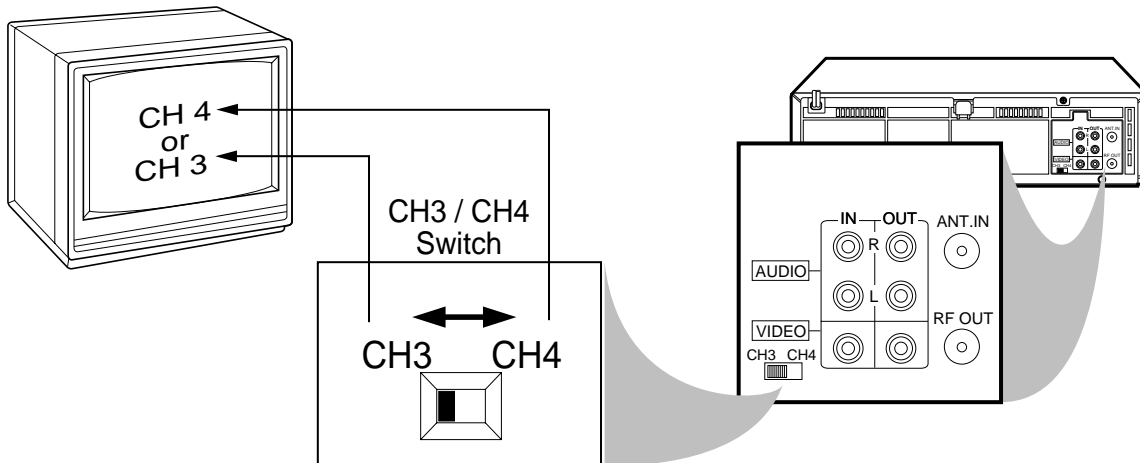

6

You are ready to turn on the VCR. Please go to page 10 before turning on the VCR.

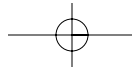

8 Hookups With a Cable Box/Direct Broadcast System

There are two ways to connect your Cable Box/DBS to the VCR. With this connection:

- You may view any channel.
- You must select channels at the Cable Box/DBS. Channels cannot be changed at the VCR.
- You may not view a channel other than the one you are recording.
- You may not set up channels at the VCR.
- You can only program a timer recording for one channel at a time. Set the TV and the VCR to the Cable Box/DBS output channel (channel 03 or 04), and set your Cable Box/DBS to the channel you want to record. When you enter the channel you want to record in a timer recording, select channel 03 or 04 (the Cable Box/DBS output channel). (This is step 3 on page 37.) Leave the Cable Box/DBS on for a timer recording.

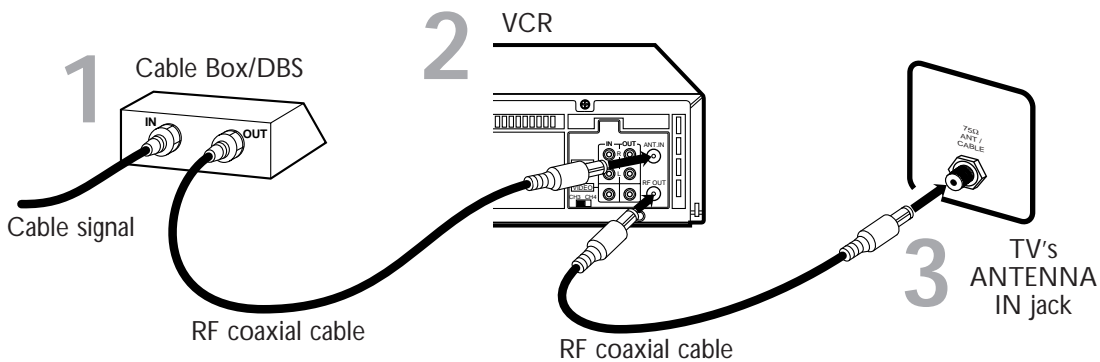

Connections

1

Connect a Cable signal to the IN jack on the Cable Box/DBS.

2

Use an RF coaxial cable (supplied) to connect the OUT jack on the Cable Box/DBS to the ANT(enna) IN jack on the VCR.

3

Use a second RF coaxial cable to connect the RF OUT jack on the VCR to the TV's ANTENNA IN jack.

Recording/Viewing Any Channel

1

With the VCR on and in VCR position (the VCR light will appear on the display panel), use the CH(annel) ▲/▼ buttons to set the VCR to the Cable Box/DBS output channel (channel 03 or 04).

2

Set the TV to the same channel to which you set the VCR.

3

Select the channel you want to view/record at the Cable Box/DBS.

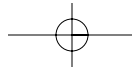

Hookups With a Cable Box/Direct Broadcast System (cont'd) 9

With this connection:

- You may watch one channel while recording another.
- You may not record scrambled channels.

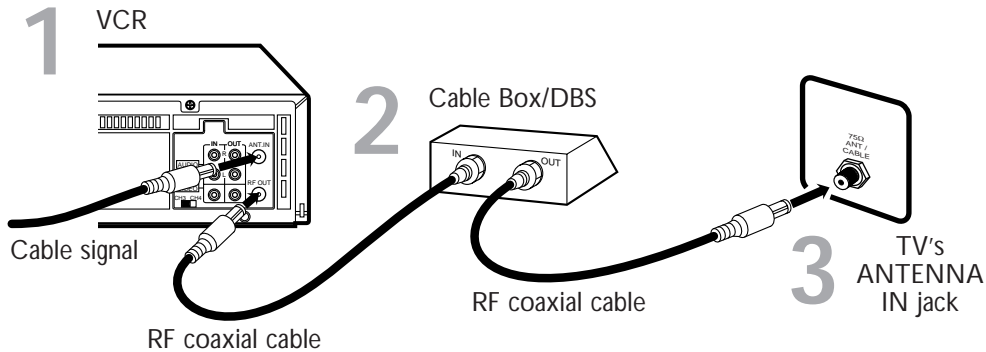

Connections

1

Connect a Cable signal to the VCR's ANT(enna) IN jack.

2

Use an RF coaxial cable (supplied) to connect the RF OUT jack on the VCR to the IN jack on the Cable Box/DBS.

3

Use a second RF coaxial cable to connect the OUT jack on the Cable Box/DBS to the TV's ANTENNA IN jack.

Recording One Channel/Watching Another

1

Put the Cable Box/DBS on the same channel as the VCR's CH3/CH4 switch. Then, with the VCR in VCR position (the VCR light will appear on the display panel), use the CH(annel) ▲/▼ buttons to select the channel you want to record at the VCR. Start the recording.

2

Press the VCR/TV button once to put the VCR in TV position. (The VCR light will disappear.)

3

Set the TV to the Cable Box/DBS output channel (03 or 04).

4

Select the channel you want to watch at the Cable Box/DBS.

Helpful Hint

- When you play a tape, make sure the Cable Box/DBS is set to the same channel as the CH3/CH4 switch on the VCR. Set the TV to the Cable Box/DBS output channel (03 or 04).



10 Turning on Your VCR

Before turning on your VCR, make sure there are batteries in the remote control and the VCR, TV, and Cable Box/DBS (if applicable) are connected and plugged in.

1

Press the VCR button, then press the POWER button.

2

Turn on the TV. Set it to channel 3 or 4, whichever the CH3/CH4 switch on the back of the VCR is set to. The menu shown below will appear.

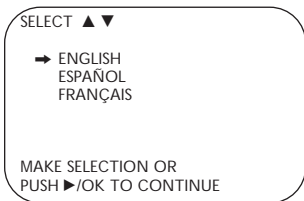

3

Press the PLAY ▲ or STOP ▼ button to select the on-screen display language.

4

Press the FF ►/OK button. The menu shown below will appear.

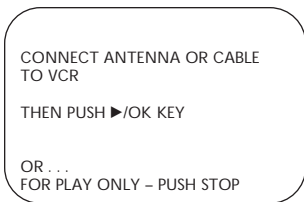

5

Press the FF ►/OK button to begin automatic channel setup. AUTO CH. SET PROCEEDING PLEASE WAIT will appear on-screen. The VCR will memorize all of the channels you receive, so when you scan through channels using the CH(annel) ▲/▼ buttons, you'll only scan through channels that you receive.

6

When channels are set up, AUTO CH. SET COMPLETED will appear briefly on screen.

2

Turn on the TV.

6

Wait for the VCR to set up channels.

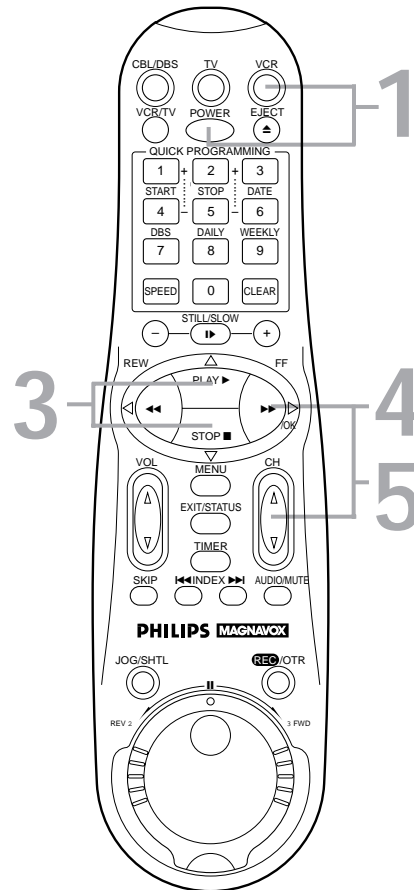

Helpful Hints

- Auto may appear on the display panel until the clock is set. After you connect the antenna/cable signal to the VCR and connect the VCR to a power source, the clock may set itself automatically. The current time may appear on the VCR display panel.
- If you do not want to set up channels now, press the STOP ▼ button at step 5. TUNER NOT SET will appear briefly on screen.
- You may not set up channels at step 5 if you are using a Cable Box/DBS.

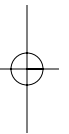
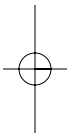

Automatic Channel Setup 11

Although your VCR may automatically memorize the channels you receive when you turn it on for the first time, this function lets you set up channels again. Make each entry within one minute of the previous entry.

1

Press the **VCR** button, then press the **MENU** button.

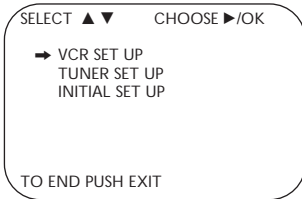

2

Press the **PLAY** ▲ or **STOP** ▼ button to select **TUNER SET UP**, then press the **FF** ►/OK button.

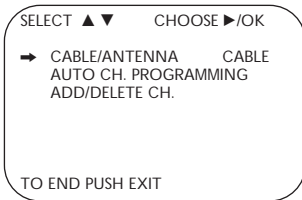

3

Press the **FF** ►/OK button repeatedly so that **ANT** (if you have an antenna) or **CABLE** (if you have a cable connection) appears beside **CABLE/AUTENNA**.

4

Press the **STOP** ▼ button to select **AUTO CH. PROGRAMMING**, then press the **FF** ►/OK button. **AUTO CH. SET PROCEEDING PLEASE WAIT** and a scale that shows the progress of channel setup will appear on screen. The VCR will memorize all the channels you receive.

5

Wait for a few minutes while the VCR sets up channels. When programming is complete, **AUTO CH. SET COMPLETED** will appear on screen. Then, the programming of the lowest channel number placed in the VCR's memory will appear on screen. Now when you press the **CH(annel)** ▲/▼ buttons, you will scan only through channels you receive.

5 Wait for the VCR to set up channels.

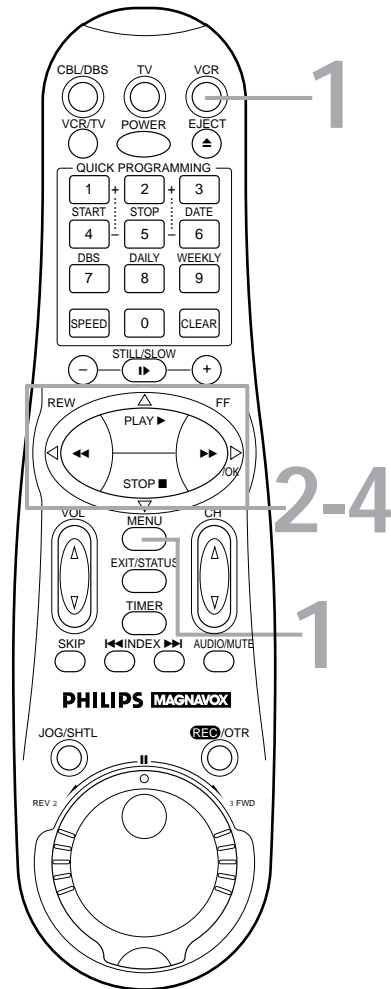

Helpful Hints

- If the channel you select has no broadcast, the screen will be solid blue.
- The two Line Input modes will always be stored in the VCR's memory at channel 00. To select **A/V IN FRONT** or **A/V IN REAR**, press 0,0, then press the **CH(annel)** ▲/▼ buttons so that **A/V IN FRONT** or **A/V IN REAR** appears briefly on screen. To exit Line Input mode, use the **CH(annel)** ▲/▼ buttons to select a channel other than 00.

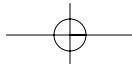

12 Automatic Channel Setup (cont'd)

Adding/Deleting Channels

1

Press the VCR button, then press the MENU button.

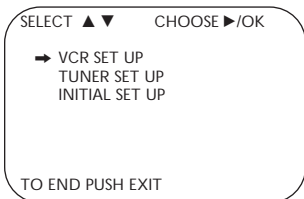

2

Press the PLAY ▲ or STOP ▼ button to select TUNER SET UP, then press the FF ►/OK button.

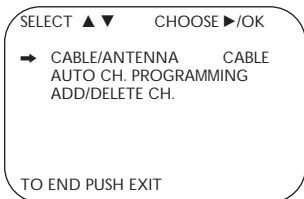

3

Press the PLAY ▲ or STOP ▼ button to select ADD/DELETE CH., then press the FF ►/OK button.

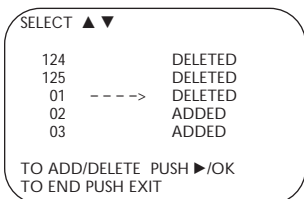

4

Use the Number buttons, the CH(annel) ▲/▼ buttons, or the PLAY ▲ or STOP ▼ buttons to select the channel you want to add or delete. An arrow will appear beside the selected channel.

5

Press the FF ►/OK button so that DELETED or ADDED appears beside the channel number.

6

Press the EXIT/STATUS button. Programming of the last channel you added or deleted will appear on screen.

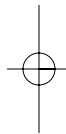
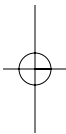
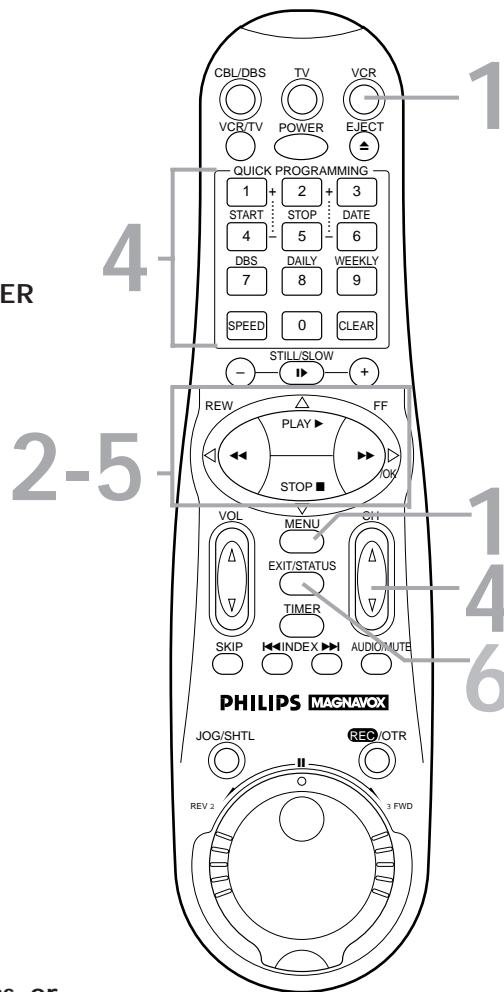

Setting the Clock 13

There are four ways to set the VCR's clock: Manually, with Time Zone Selection, with Manual PBS Channel Selection, or with Automatic PBS Channel Selection. Cable Box/DBS users must set the clock manually. Before you set the clock, make sure:

- The VCR power is on.
- The VCR light appears on the display panel. If it does not, press the VCR/TV button once.
- Channels are set up.
- You make each entry within one minute of the previous entry.

To set the clock manually, follow the steps on this page. To use Time Zone Selection, go to page 15. To use Manual PBS Channel selection, go to page 16. To use Automatic PBS Channel Selection, go to page 17.

Manual Clock Setting

1

Press the VCR button, then press the MENU button.

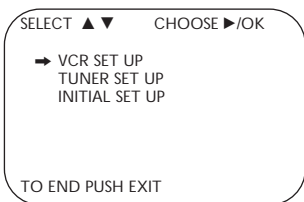

2

Press the PLAY ▲ or STOP ▼ button to select INITIAL SET UP, then press the FF ►/OK button.

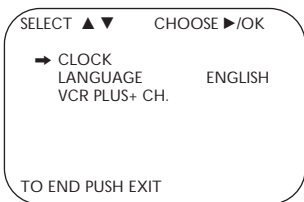

3

Press the PLAY ▲ or STOP ▼ button to select CLOCK, then press the FF ►/OK button.

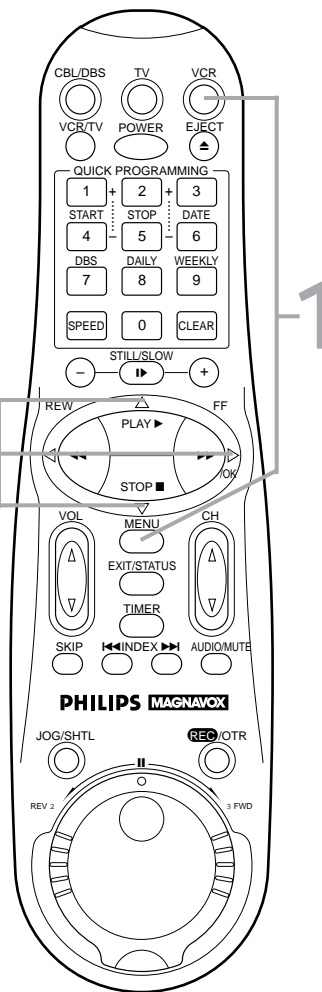
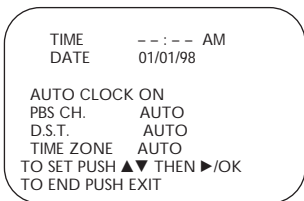

Helpful Hints

- To program the VCR so its clock will automatically move forward one hour in April and turn back one hour in October, see page 18.
- To make corrections, follow steps 1 - 3, then press the FF ►/OK button until the item you want to correct is flashing. Then press the PLAY ▲ or STOP ▼ button to enter the correct information. Press the EXIT/STATUS button.

Instructions continue on page 14.

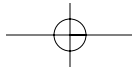

14 Setting the Clock (cont'd)

4

Press the **PLAY ▲** or **STOP ▼** button repeatedly to set the **TIME**. Every time you press the **PLAY ▲** or **STOP ▼** button, the time changes in one minute increments. If you press and hold the **PLAY ▲** or **STOP ▼** button, the time changes in 30 minute increments.

When the time is correct, press the **FF ►/OK** button.

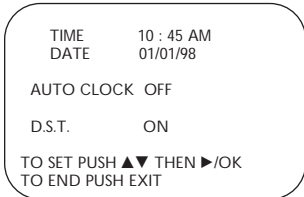

5

Press the **PLAY ▲** or **STOP ▼** button repeatedly to set the **DATE (month and day)**. Every time you press the **PLAY ▲** or **STOP ▼** button, the day changes in one day increments. If you press and hold the **PLAY ▲** or **STOP ▼** button, the day changes in 15 day increments.

When the month and day are correct, press the **FF ►/OK** button.

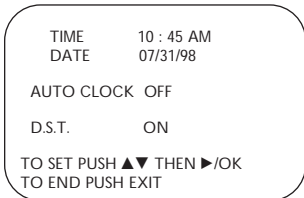

6

Press the **PLAY ▲** or **STOP ▼** button repeatedly to set the **YEAR**. When the year is correct, press the **FF ►/OK** button. The day of the week will appear automatically.

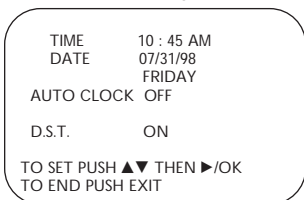

7

Press the **FF ►/OK** button once again to skip the "AUTO CLOCK" selection and go to "D.S.T." (Daylight Saving Time) selection. Press the **PLAY ▲** or **STOP ▼** button to set **D.S.T. to ON, OFF or AUTO**. If **AUTO CLOCK** is set to **OFF**, you may only set **D.S.T. to ON or OFF**. For more information, please see page 18.

8

Press the **EXIT/STATUS** button.

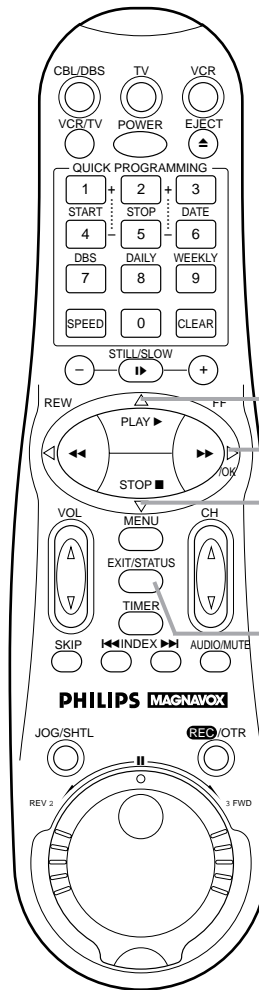

4-7

8

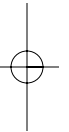
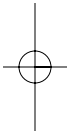

Setting the Clock (cont'd) 15

Time Zone Selection

1

Press the VCR button, then press the MENU button.

2

Press the PLAY ▲ or STOP ▼ button to select INITIAL SET UP, then press the FF ►/OK button.

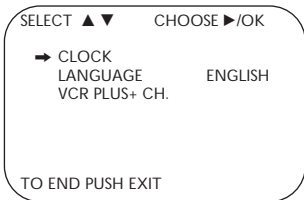

3

Press the PLAY ▲ or STOP ▼ button to select CLOCK, then press the FF ►/OK button.
(If AUTO CLOCK is set to OFF, TIME ZONE will not be available in the menu. If this happens, press the FF ►/OK button to select AUTO CLOCK, then press the PLAY ▲ or STOP ▼ button to set AUTO CLOCK to ON.)

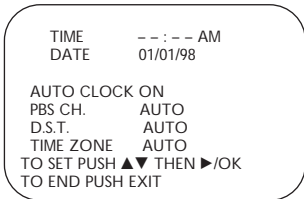

4

Press the FF ►/OK button repeatedly to select TIME ZONE.

5

Press the PLAY ▲ or STOP ▼ button repeatedly to select your Time Zone, then press the FF ►/OK button.

6

Press the EXIT/STATUS button.

7

An on-screen message will ask you to turn off the VCR, and ---:-- AM will appear on the display panel. Press the POWER button to turn off the VCR. Auto will flash in the display panel until the clock is set. Leave the VCR turned off until the time appears on the display panel. If ---:-- appears on the display panel after you turn off the VCR, the VCR could not find the time. Set the clock following the steps on pages 13 - 14.

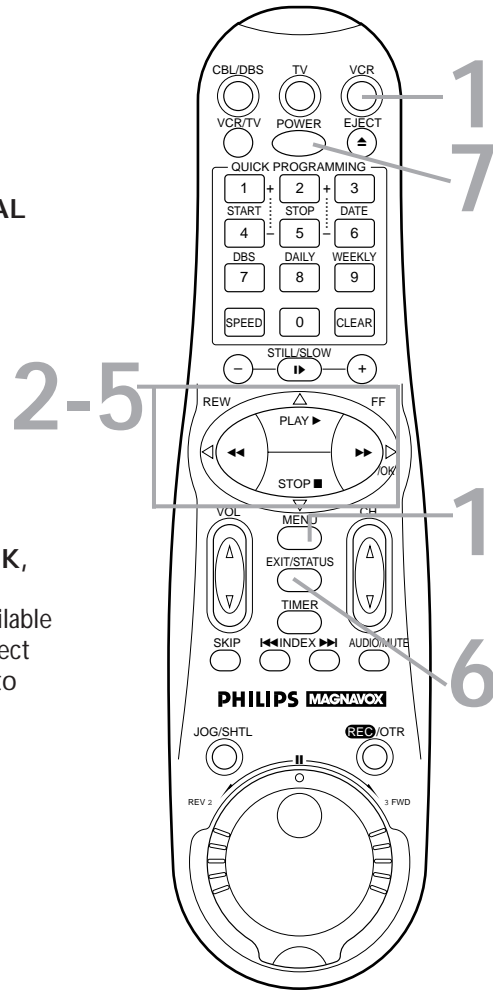

Helpful Hints

- When the power plug is connected to an AC outlet, the correct time will appear on the display panel of the VCR (when the power is off).
- If you live near the boundary of an adjacent time zone, your PBS channel may come from a different time zone. Select the time zone of your PBS channel at step 5.
- Press the EXIT/STATUS button repeatedly to make the time appear on the display panel when the VCR power is on.

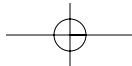

16 Setting the Clock (cont'd)

Manual PBS Channel Selection

1

Press the VCR button, then press the MENU button.

2

Press the PLAY ▲ or STOP ▼ button to select INITIAL SET UP, then press the FF ►/OK button.

3

Press the PLAY ▲ or STOP ▼ button to select CLOCK, then press the FF ►/OK button. (If AUTO CLOCK is set to OFF, PBS CH. will not be available in the menu. If this happens, press the FF ►/OK button to select AUTO CLOCK, then press the PLAY ▲ or STOP ▼ button to set AUTO CLOCK to ON.)

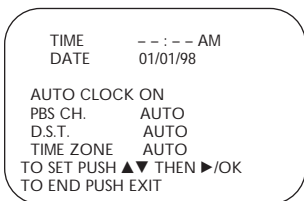

4

Press the FF ►/OK button to select PBS CH.

5

Press the PLAY ▲ or STOP ▼ button repeatedly to select the station number of your PBS channel, then press the FF ►/OK button.

6

Press the EXIT/STATUS button.

7

An on-screen message will ask you to turn off the VCR, and -- : -- AM will appear on the display panel.

Press the POWER button to turn off the VCR.

Auto will flash in the display panel until the clock is set. Leave the VCR power off until the clock is set.

If -- : -- appears on the display panel after you turn off the VCR, the VCR could not find the time. Repeat steps 1 - 6 above, entering a different PBS channel at step 5. Or, set the clock following the steps on page 17.

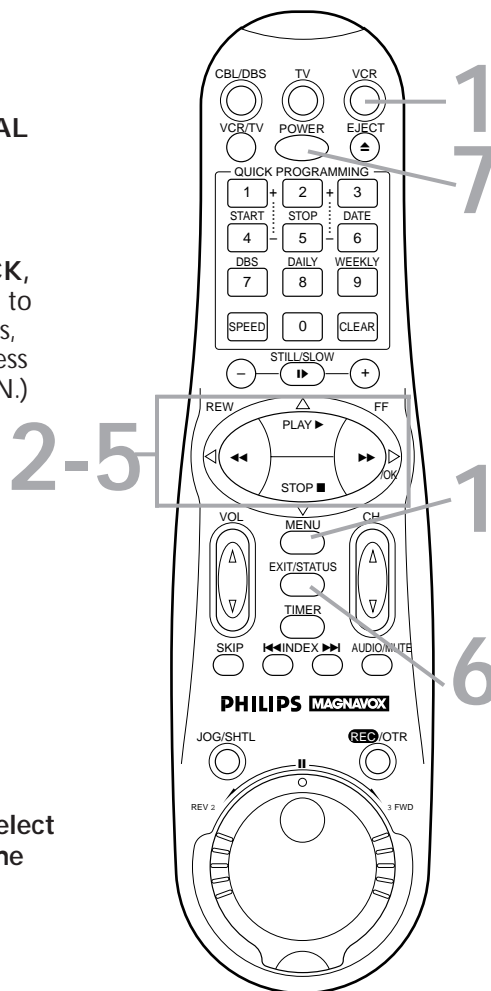

Helpful Hint

- The time will be updated at the top of each hour (except at 11 p.m., midnight, 1 a.m., and 2 a.m.).

Setting the Clock (cont'd) 17

Automatic PBS Channel Selection

1

Press the VCR button, then press the MENU button.

2

Press the PLAY ▲ or STOP ▼ button to select INITIAL SET UP, then press the FF ►/OK button.

3

Press the PLAY ▲ or STOP ▼ button to select CLOCK, then press the FF ►/OK button. (If AUTO CLOCK is set to OFF, PBS CH. will not be available in the menu. If this happens, press the FF ►/OK button to select AUTO CLOCK, then press the PLAY ▲ or STOP ▼ button to set AUTO CLOCK to ON.)

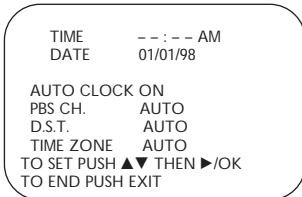

4

Press the FF ►/OK button repeatedly to select PBS CH.

5

Press the PLAY ▲ or STOP ▼ button repeatedly so that AUTO flashes beside PBS CH. Then press the FF ►/OK button.

6

Press the EXIT/STATUS button.

7

An on-screen message will ask you to turn off the VCR, and -- : -- AM will appear on the display panel.

Press the POWER button to turn off the VCR.

Auto will flash in the display panel until the clock is set. Leave the VCR power off until the clock is set. If -- : -- appears on the display panel after you turn off the VCR, the VCR could not find the time. You may need to tell the VCR the PBS channel from which to take the time. Follow the steps on page 16.

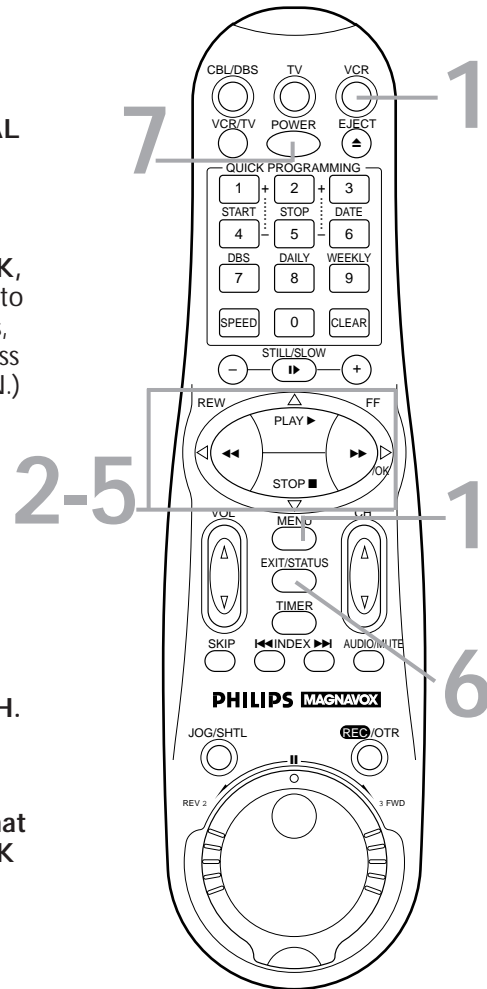

Helpful Hints

- The time will be updated at the top of each hour (except at 11 p.m., midnight, 1 a.m., and 2 a.m.).
- To display the time on-screen, press the EXIT/STATUS button. (ON SCREEN MODE can not be set to OFF.) Details are on page 26.

18 Daylight-Saving Time

Follow the steps below to program the VCR so its clock will automatically move forward one hour in April and turn back one hour in October.

1

Press the VCR button, then press the MENU button.

2

Press the PLAY ▲ or STOP ▼ button to select INITIAL SET UP, then press the FF ►/OK button.

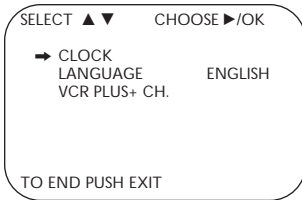

3

Press the PLAY ▲ or STOP ▼ button to select CLOCK, then press the FF ►/OK button. (If AUTO CLOCK is set to OFF, PBS CH. and TIME ZONE will not appear in the menu.)

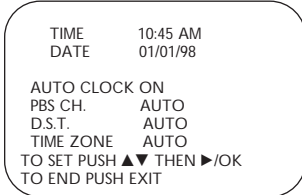

4

Press the FF ►/OK button repeatedly to select D.S.T.

5

Press the PLAY ▲ or STOP ▼ button so that ON, OFF, or AUTO appears beside D.S.T. Select ON to make the clock adjust itself according to the VCR's calendar. Select OFF to turn off the feature. Select AUTO to make the clock adjust itself according to the signal it receives from the PBS channel. If AUTO CLOCK is set to OFF, you may only set D.S.T. to ON or OFF.

6

Press the EXIT/STATUS button.

7

An on-screen message will ask you to turn off the VCR if you set D.S.T. to ON or AUTO. Press the POWER button to turn off the VCR. Auto will flash in the display panel until the clock is set. Leave the VCR power off until the clock is set. If -- : -- appears on the display panel after you turn off the VCR, the VCR could not find the time. You may need to tell the VCR the PBS channel from which to take the time. Follow the steps on page 16.

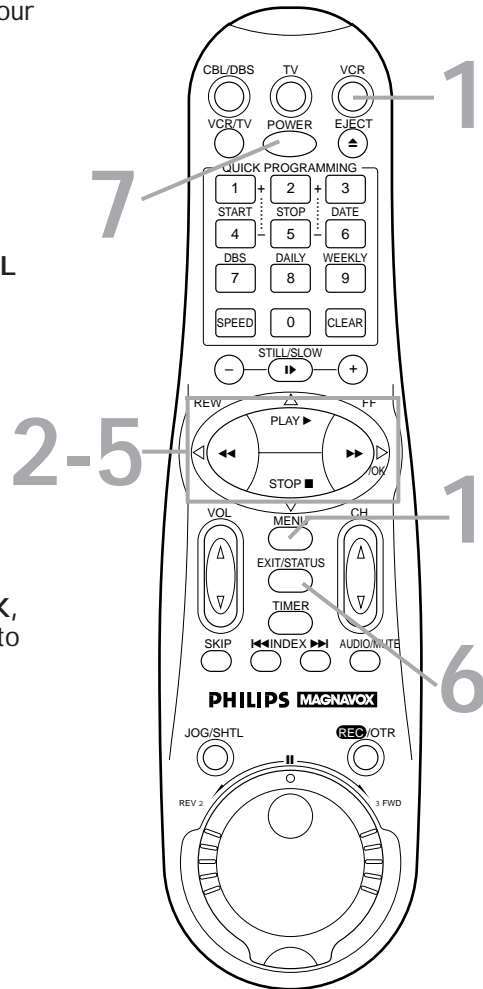

Language Selection 19

Follow the steps below to change the language of the on-screen displays.

1

Press the VCR button, then press the MENU button.

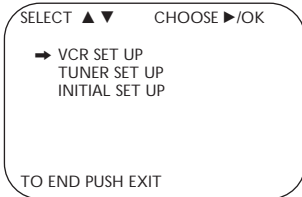

2

Press the PLAY ▲ or STOP ▼ button to select INITIAL SET UP, then press the FF ►/OK button.

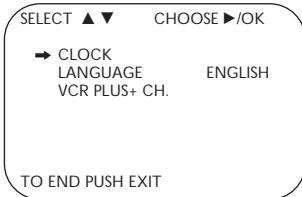

3

Press the STOP ▼ button to select LANGUAGE.

4

Press the FF ►/OK button repeatedly so that the language you want to select appears on-screen.

5

Press the EXIT/STATUS button.

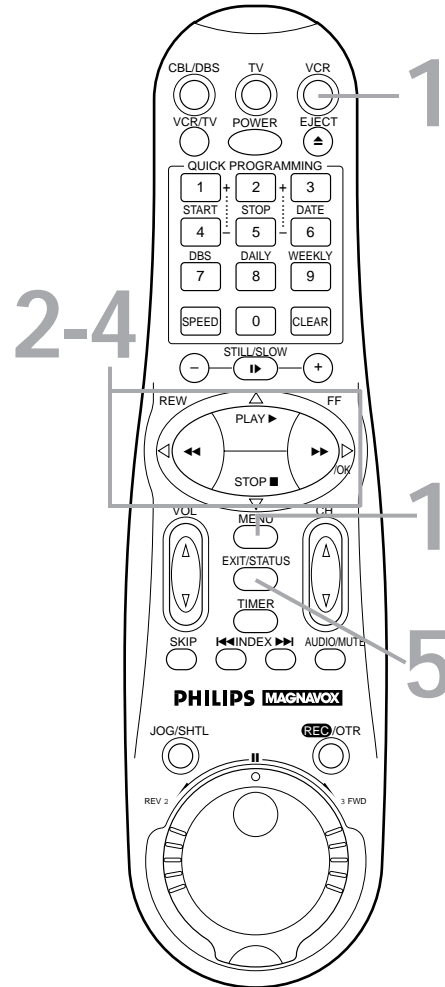

Helpful Hint

- If you accidentally select Spanish or French on-screen displays and need English on-screen displays, follow these steps. 1) Press the VCR button, then press the MENU button. 2) Press the PLAY ▲ or STOP ▼ button to select SISTEMA INICIAL or PROGRAMM. INITIALE, then press the FF ►/OK button. 3) Press the PLAY ▲ or STOP ▼ button to select LENGUAJE or LANGUE. 4) Press the FF ►/OK button repeatedly so that the English menu appears. 5) Press the EXIT/STATUS button.

20 Remote Control Buttons

TV Button

Press this button before pressing other TV operation buttons.

CBL/DBS Button

Press this button before pressing Cable box/DBS operation buttons.

VCR/TV Button

Press to select the signal that your TV receives.

• VCR Position

Use to watch a tape, to watch a program while recording it, or to watch a TV broadcast using the CH(annel) ▲/▼ or Number buttons to change channels at the VCR. The VCR light will appear on the display panel when the VCR is in VCR position.

• TV Position

Use to watch TV (selecting channels at the TV) or to watch one program while recording another.

Details are on page 32. The VCR light will not appear when the VCR is in TV position.

PLAY ▲ Button

In VCR mode, press to play a tape. Also, press to release Slow, Still, or Search mode and to return to normal playback. *Details are on pages 49-50.* In TV mode, press to move up or forward one row or selection in the TV menu.

REW(ind) ◀ Button

When tape playback is stopped, press to rewind the tape at high speed. During tape playback, press to rewind the tape while the picture stays on screen. *Details are on page 49.* Press to adjust (decrease) the picture controls or to change a menu setting at the TV menu.

JOG/SHTL (shuttle) Button

Press to use the Jog Dial or the Shuttle Ring.

Shuttle Ring

While in the Play or Still mode, turn this ring in either direction. The farther the ring is rotated, the faster the search speed. Releasing the ring stops the picture in the Still mode.

For details, see page 50.

VCR Button

Press this button before pressing VCR operation buttons.

EJECT Button

Press to eject the tape.

POWER Button

After pressing the CBL/DBS, VCR, or TV button, press to turn on or off the Cable Box/DBS, VCR, or TV.

Number Buttons

After pressing the CBL/DBS, TV, or VCR button, press to select a channel at the Cable Box/DBS, TV, or VCR. To select channels 1-9, press 0, then the channel you want. For example, to select channel 7, press 0, 7.

CLEAR Button

Press to reset the real-time counter to zero.

FF (Fast Forward) ▶/OK Button

When tape playback is stopped, press to advance the tape at high speed. During tape playback, press to advance the tape while the picture stays on screen. *Details are on page 49.* Or, press to adjust (increase) the picture controls or to change a menu setting at the TV menu.

STOP ▼ Button

Press to stop the tape. Or press to move down or backward one row or selection in the TV menu.

REC(ord)/OTR Button

Press once to start a recording. *Details are on page 30.* Or, press repeatedly to start a One-Touch Recording. *Details are on page 31.*

Jog Dial

Turn this dial while in the Still mode for jog control. The tape moves backward or forward frame-by-frame at the speed with which the dial is turned. *For details, see page 50.*

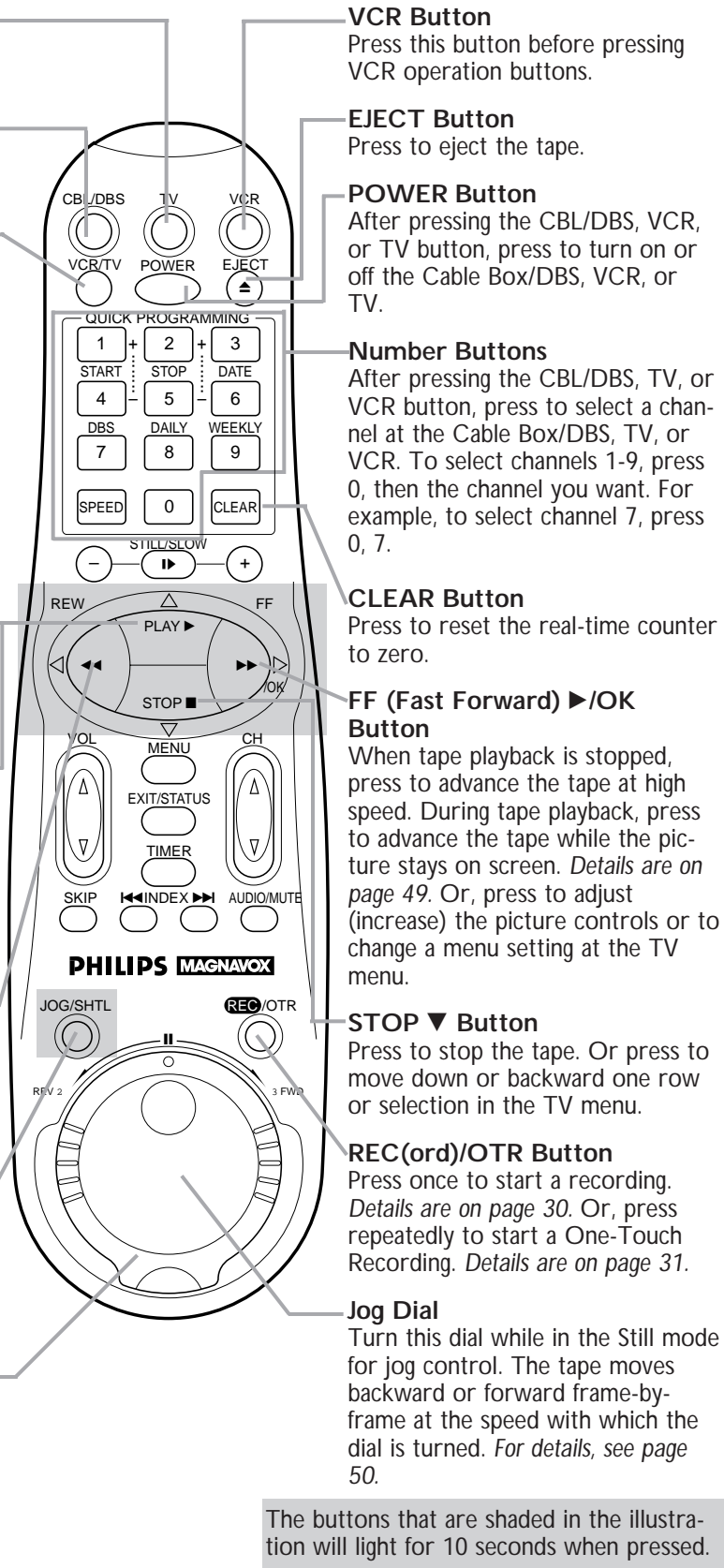

The buttons that are shaded in the illustration will light for 10 seconds when pressed.

Remote Control Buttons (cont'd) 21

SPEED Button

Press to select the recording speed (SP or SLP). *Details are on pages 38 and 52.*

STILL/SLOW +/- Buttons

During slow motion tape playback, press to adjust the playback speed. *Details are on page 49.*

MENU Button

Press to access the main VCR menu. Or, press the TV button, then the MENU button, to access the TV menu.

VOL(ume) ▲/▼ Buttons

Press to increase or decrease the TV's volume.

SKIP Button

Press during tape playback to fast forward 30 seconds of a tape. This feature will only work with tape segments recorded in SP or SLP speed.

EXIT/STATUS Button

Press to exit on-screen menus. Press to bring up the status display for five seconds. *Details are on page 26.* When tape playback is stopped, press repeatedly to see the time, real-time counter, or current channel number on the display panel. During tape playback, press repeatedly to see the time or the real-time counter on the display panel. Or, press the TV button, then press the EXIT/STATUS button, to access the TV on-screen displays or to exit the TV menu.

The buttons that are shaded in the illustration will light for 10 seconds when pressed.

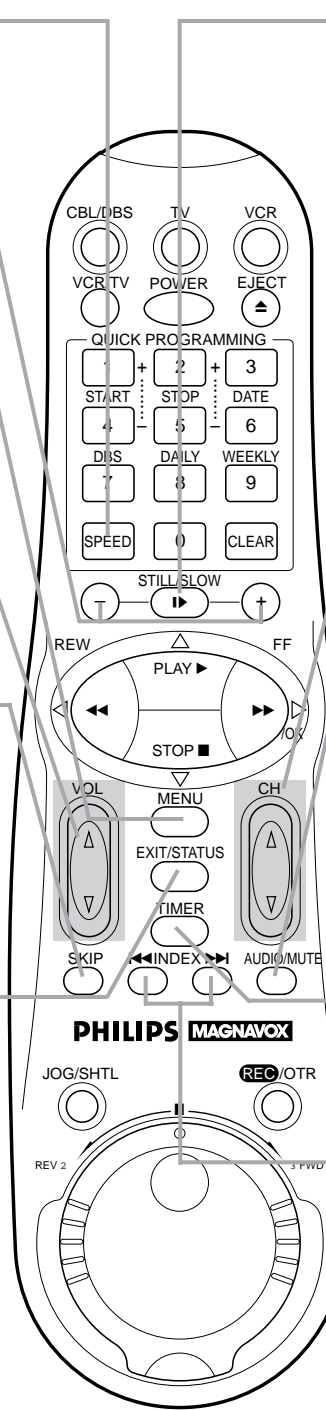

STILL/SLOW Button

While recording, press to temporarily stop the recording. Press a second time to resume normal recording. *Details are on page 30.* During tape playback, press once to freeze the picture. Press repeatedly to advance the Still picture frame by frame. *Details are on page 49.* During tape playback, press and hold for more than three seconds to play the tape in slow motion. *Details are on page 49.*

CH(annel) ▲/▼ Buttons

After pressing the CBL/DBS, TV, or VCR button, press to scan through the channels of the Cable Box/DBS, TV, or VCR.

AUDIO/MUTE Button

Press the TV button, then press the AUDIO/MUTE button to eliminate the TV's sound. Press again to restore the sound. Or, press the VCR button, then press the AUDIO/MUTE button, to select MONO or HIFI. *Details are on pages 44 - 46.*

TIMER Button

Press to access the timer recording menu. *Details are on pages 35 - 40.*

INDEX Buttons

When tape playback is stopped, press to search for index codes recorded on the tape. *Details are on page 43.*

Helpful Hint

- This remote control may or may not operate your TV or Cable Box/DBS. Or, it may only work some features of this equipment. See pages 27 - 28 for details.

22 Display Panel

VCR Display Panel

Information about VCR operations appears here. Different information appears at different times. The display is brighter when the VCR power is on. The display dims automatically when you turn off the VCR power.

Remote Sensor

Receives a signal from your remote control so you can operate your VCR from a distance. Press the VCR button on the remote control before pressing other VCR operation buttons.

Cassette Compartment

Insert a tape here.

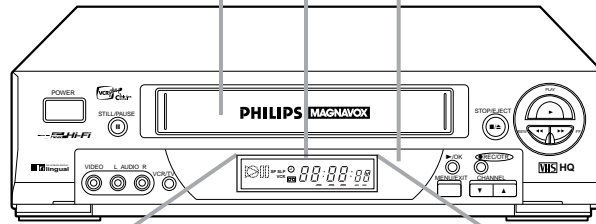

TIMER Light

This light appears when a timer recording is programmed or is in progress. *Details are on pages 35 - 40.* This light blinks rapidly if the VCR is turned off to set a Timer Recording but a tape is not in the VCR.

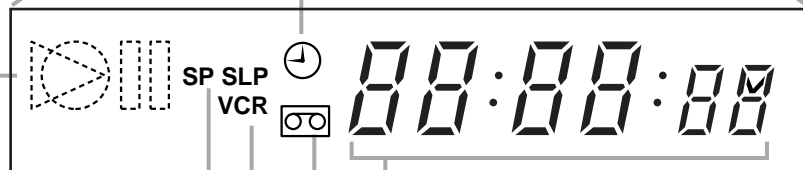

Operation indicators

These indicators tell you the current operation of the VCR.

- ▷: Play, Forward and Reverse Searching
- : Record
- : Record Pause
- ▷□□: Still Picture

Tape Speed Lights

This light indicates the current tape speed. This VCR will play tapes recorded in LP speed, but LP will not appear on the display panel. This VCR will not record in LP speed. *Details on tape speeds are on pages 38 and 52.*

VCR Light

This light appears when the VCR is in VCR position.

Cassette Inside Light

This light appears when a tape is in the VCR. It blinks when a tape is being ejected. This light blinks rapidly if the VCR is turned off to set a Timer Recording but there is not a tape in the VCR.

Clock/Counter/Channel Display

Each time you press the EXIT/STATUS button, information on the display panel will change. When tape playback is stopped, press the EXIT/STATUS button repeatedly to see: the current time (when the clock is set); the real-time counter; and the current channel number. During tape playback, press the EXIT/STATUS button repeatedly to see the real-time counter or the current time.

Line Input Mode Light

When L appears here, the VCR is in Line Input mode. When L-F appears, you have selected A/V IN FRONT. Your audio and video cables should be connected to the AUDIO/VIDEO jacks on the front of the VCR if you are dubbing tapes. When L-1 appears here, you have selected A/V IN REAR. Your audio and video cables should be connected to the AUDIO/VIDEO jacks on the back of the VCR if you are dubbing tapes. To select A/V IN FRONT or A/V IN REAR, press 0,0, then press the CH(annel) ▲/▼ buttons so that A/V IN FRONT or A/V IN REAR appears on-screen briefly. To exit Line Input mode, press the Number buttons or the CH(annel) ▲/▼ buttons to select another channel.

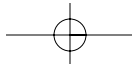

Front Panel 23

REC(ord)/OTR Button

Press once to record. *Details are on page 30.* Press repeatedly to start a One-Touch Recording. *Details are on page 31.*

▶/OK Button

During menu operation press to settle the settings or to go to the next step.

POWER Button

Press to turn the VCR power on and off.

STILL/PAUSE Button

During tape playback, press once to freeze the picture. Press repeatedly to advance the Still picture frame by frame. *Details are on page 49.* During recording, press to temporarily stop the recording. Press a second time to resume recording. *Details are on page 30.*

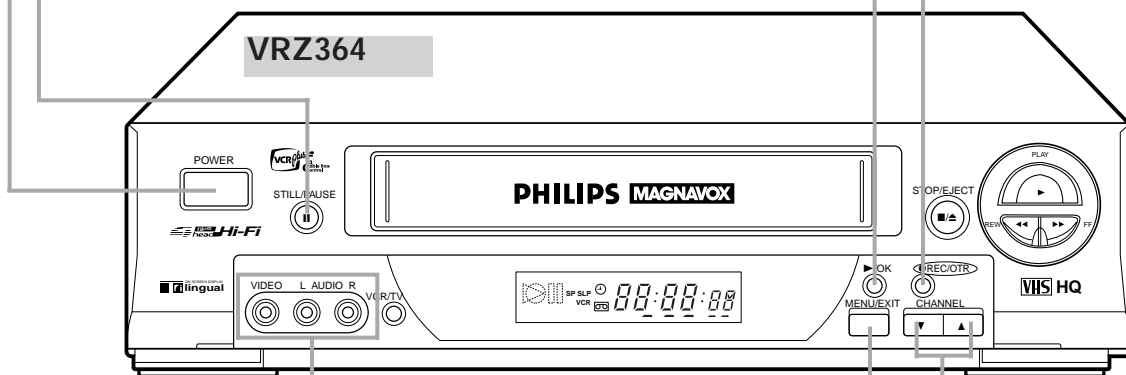

Front VIDEO/AUDIO In Jacks

Connect cables coming from the VIDEO and AUDIO OUT Jacks of another VCR or a camcorder here. *Details are on page 42.* The VRZ364 is shown here. The VRZ344 has only one AUDIO In Jack.

MENU/EXIT Button

Press to access the main VCR menu. Press to exit on-screen menus. Press to bring up the status display for five seconds *Details are on page 26.*

CHANNEL ▲/▼ Buttons

Press to scan through the VCR's channels. During tape playback, press to manually adjust the tracking. *Details are on page 51.* During menu operation, press to select the item or change the setting.



24 Front Panel (cont'd)

FF (Fast Forward) Button

When tape playback is stopped, press to fast forward the tape at high speed. During tape playback, press to fast forward the tape while the picture stays on-screen. *Details are on page 49.*

PLAY Button

Press to play a tape. Also, press to release Slow, Still, or Search mode and return to normal playback. *Details are on page 49.*

REW(ind) Button

When tape playback is stopped, press to rewind the tape at high speed. During tape playback, press to rewind the tape while the picture stays on-screen. *Details are on page 49.*

POWER Button

Press to turn the VCR power on and off.

STOP/EJECT Button

Press once to stop the tape. When tape playback is stopped, press to eject the tape.

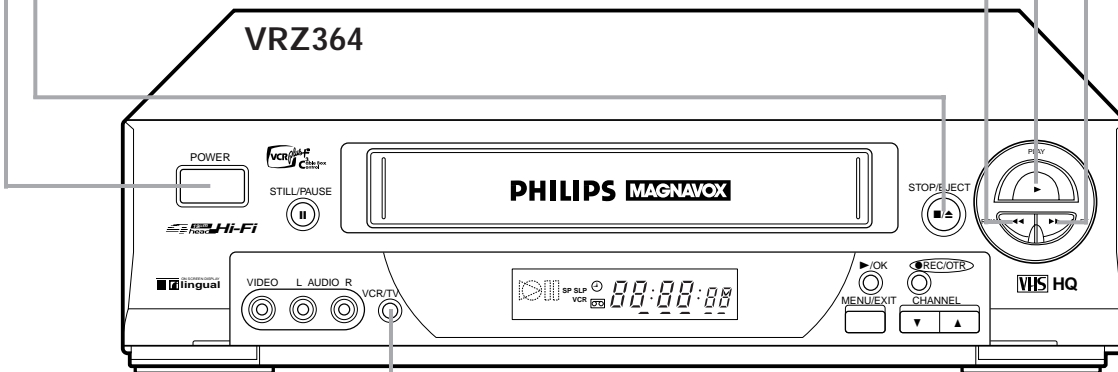

VCR/TV Button

Press to select the signal that your TV receives.

VCR Position:

Use to watch a tape, to watch a program while recording it, or to watch a TV broadcast using the CH(annel) ▲/▼ or Number buttons to change channels at the VCR. The VCR light will appear on the display panel when the VCR is in VCR position.

TV Position:

Use to watch TV or to watch one program while recording another. *Details are on page 32.* The VCR light will not appear on the display panel when the VCR is in TV position.

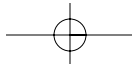

Rear Panel 25

ANT(enna) IN Jack

Connect your antenna or cable here. *Details are on pages 6 - 9.*

AUDIO OUT Jacks

Connect cables going to the AUDIO IN jacks of a camcorder, another VCR, or an audio source here. *Details are on pages 42 and 45.*
The VRZ364 is shown here. The VRZ344 has only one AUDIO OUT Jack.

AUDIO IN Jacks

Connect cables coming from the AUDIO OUT jacks of a camcorder, another VCR, or an audio source here. *Details are on page 42.*
The VRZ364 is shown here. The VRZ344 has only one AUDIO IN Jack.

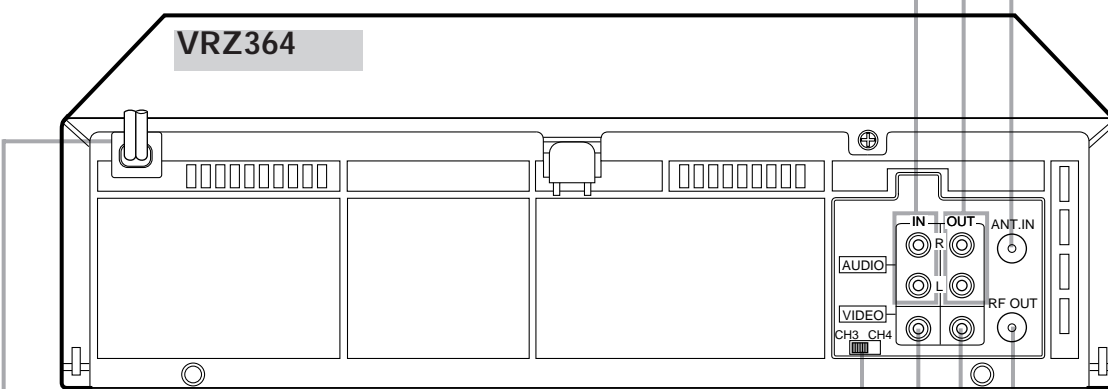

CH3/CH4 Switch

Set to channel 3 or 4 to use your TV with your VCR. Set your TV to the same channel. *Details are on pages 6 - 9.*

VIDEO IN Jack

Connect a cable coming from the VIDEO OUT jack of a camcorder or another VCR here. *Details are on page 42.*

VIDEO OUT Jack

Connect a cable going to the VIDEO IN jack of a camcorder or another VCR here. *Details are on pages 42 and 45.*

AC Power Cord

Connect to a wall outlet (120 V) to supply power to the VCR.

RF OUT Jack

Use the supplied RF coaxial cable to connect this jack to the ANTENNA IN Jack on your TV or to the IN Jack on your Cable Box/DBS (if applicable). *Details are on pages 6 - 9.*

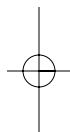
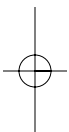



26 On-Screen Status Displays

An on-screen status display, which includes the current time, channel, and other information (see illustration of the status display at right), will appear when you press the EXIT/STATUS button or certain function buttons. The contents of the status display may vary.

ON SCREEN MODE ON:

- Whenever you press the PLAY ▲ button or the STOP ▼ button to stop playback, some of the contents of the status display will appear for five seconds.

ON SCREEN MODE COUNTER:

- The tape counter will appear on-screen at all times. Whenever you press the PLAY ▲ button or the STOP ▼ button to stop playback, some of the contents of the status display will appear for five seconds. After five seconds, only the counter will remain on the screen.

ON SCREEN MODE OFF:

- No status display will appear when you press function buttons or the EXIT/STATUS button.

To select a status display mode, follow these steps.

1

Press the VCR button, then press the MENU button.

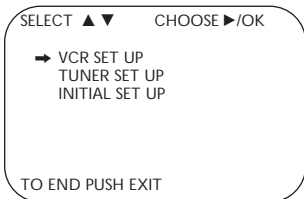

2

Press the PLAY ▲ or STOP ▼ button to select VCR SET UP, then press the FF ►/OK button.

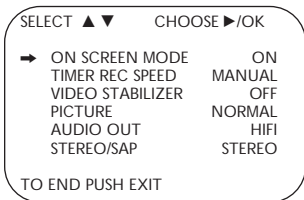

3

Press the PLAY ▲ or STOP ▼ button to select ON SCREEN MODE, if necessary.

4

Press the FF ►/OK button repeatedly so that ON, COUNTER, or OFF appears beside ON SCREEN MODE.

5

Press the EXIT/STATUS button.

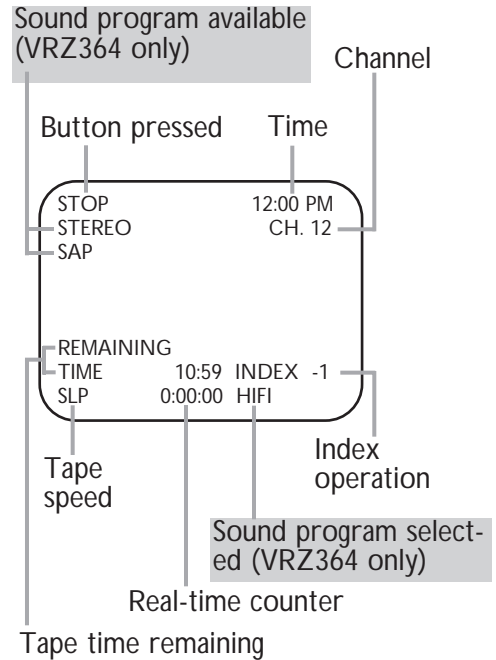

Helpful Hints

- If ON SCREEN MODE is set to ON or COUNTER:
 - You may bring up the status display at any time by pressing the EXIT/STATUS button. (The exception is during Slow, Search, or Still mode.) The display will appear for about five seconds.
 - Channel numbers (when tuned) will appear for a few seconds.
- When tape playback is stopped, press the EXIT/STATUS button to see the time, real-time counter, or current channel number on the display panel. During tape playback, press the EXIT/STATUS button to see the time or real-time counter on the display panel. The channel will not appear.
- Depending on the type of tape used, the tape time remaining may not appear right away, or may not be correct. Also, “- - : - -” may appear, or the display may flash.

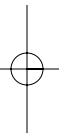
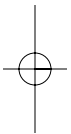

Setting the Remote Control to Operate a TV 27

Your VCR remote control may operate your TV. Follow these steps to set the remote control code.

1

Point the remote control at your TV. Press the **TV** button, then press the **POWER** button. If your TV turns on or off, try the CH(annel) ▲/▼ buttons. If your remote control operates the TV, you're finished. If your TV doesn't turn on or off, or if the CH(annel) ▲/▼ buttons don't work, go to step 2.

2

Find the brand of your TV on the list below, and remember the two-digit number beside it.

TV CODES	
EMERSON14	RCA10
GOLDSTAR04	SAMSUNG18
HITACHI12	SANYO11
JVC05	SHARP16
MAGNAVOX01, 02, 03	SONY09
MITSUBISHI13	TOSHIBA08
PANASONIC07, 17	ZENITH06, 15
PHILIPS01	
PHILIPS MAGNAVOX	
.01, 02, 03	

3

While you press and hold the **TV** button, use two **Number** buttons to enter the two-digit code for your TV. For example, if you have a Zenith TV, press Number buttons 1, 5. Then, still holding the **TV** button, press the **STOP ▼** button.

4

Repeat step 1. If the remote control works your TV, you're finished. If the remote control still doesn't work your TV, repeat steps 2 - 3, using a different code for your brand.

2 Find the code for your TV.

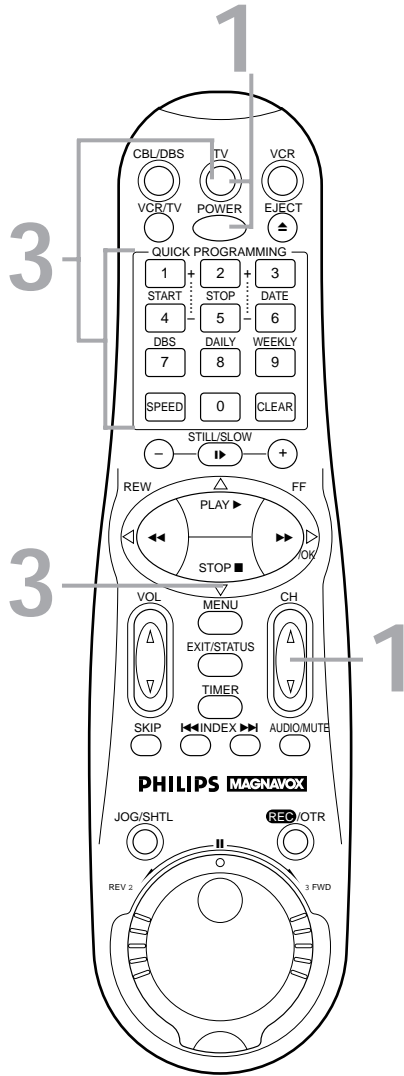

Helpful Hints

- If you had to program the remote control to operate your TV, whenever you replace the batteries in the remote control, you will have to program the remote control again.
- There is no guarantee that the remote control will work your TV.
- The remote control may only operate some features of your TV.

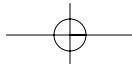

28 Setting the Remote Control to Operate a Cable Box/DBS

Your VCR remote control may operate your Cable Box/DBS. Follow these steps to set the remote control code.

1

Point the remote control at your Cable Box/DBS. Press the **CBL/DBS** button, then press the **POWER** button. If your Cable Box/DBS turns on or off, try the **CH(annel) ▲/▼** buttons. If the remote control operates the Cable Box/DBS, you're finished. If your Cable Box/DBS does not turn on or off, or if the **CH(annel) ▲/▼** buttons don't work, go to step 2.

2

Find the brand of your Cable Box/DBS on the list below and remember the two-digit number beside it.

CABLE BOX/DBS CODES	
ARCHER01, 05, 17	REGAL10, 18, 19, 23
CABLETENNA01, 17	REGENCY19
CABLEVIEW 15, 16, 17, 21, 25	REMBRANDT01, 16, 17
CITIZEN . . .15, 16, 17, 21, 25	SAMSUNG05, 16, 24
CURTIS02, 08	SCIENTIFIC ATLANTA 02, 08
DIAMOND01, 17	SIGMA07, 20
EASTERN19	SL MARX . .05, 16, 17, 24, 25
GC BRAND 15, 16, 17, 21, 25	SPRUCER13, 14
GEMINI15	STARGATE . . .05, 15, 16, 17,
GENERAL INSTRUMENTS21, 24, 25
.01, 04, 06, 11, 12, 15	TELEVIEW05, 16, 24
HAMLIN10, 18, 19, 23	TOCOM01, 04, 16
JASCO15	UNIKA01, 17
JERROLD	UNIVERSAL16, 17, 25
.01, 04, 06, 11, 12, 15	VIDEOWAY03, 09, 22
NOVAVISION02, 08	ZENITH03, 09, 22
OAK07, 20	
PANASONIC13, 14	MAGNAVOX DBS . . .42, 43
PULSAR . . .15, 16, 17, 21, 25	RCA DBS40, 44
RCA13, 14	SONY DBS41

3

While you press and hold the **CBL/DBS** button, use two **Number** buttons to enter the two-digit code for your **Cable Box/DBS**. For example, if you have a Zenith Cable Box, press **Number** buttons 0, 3. **Then, still pressing the CBL/DBS button, press the STOP ▼ button.**

4

Repeat step 1. If the remote control still does not work your Cable Box/DBS, repeat steps 2 - 3 using a different code for your brand.

2

Find the code for your Cable Box/DBS.

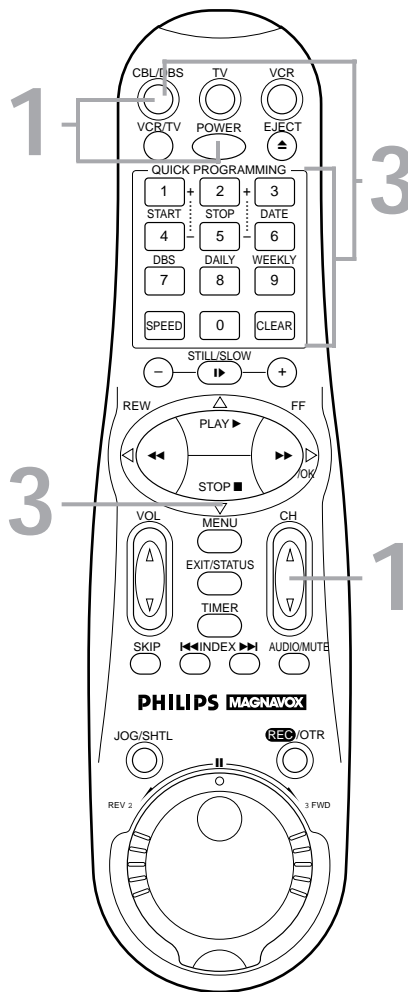

Helpful Hints

- If you had to program the remote control to operate your Cable Box/DBS, whenever you replace the batteries in the remote control, you must program the remote control again.
- The remote control may only operate some features of your Cable Box/DBS.
- Some Cable Boxes/DBSs can only be turned on at the Cable Box/DBS.
- There is no guarantee that the remote control will operate your Cable Box/DBS.

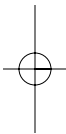

Playing 29

Read and follow the steps below to play a tape.

1

Turn on the TV and set it to channel 3 or 4, whichever the CH3/CH4 switch on the back of the VCR is set to.

2

Insert a tape in the VCR. The power will come on. The VCR will place itself in VCR position automatically (the VCR light will appear on the display panel of the VCR). If the VCR light does not appear, press the VCR/TV button once. If the tape's record tab has been removed, playback will start automatically.

3

If playback does not start automatically, press the **PLAY** button. The \triangleright light will appear on the VCR display panel.

4

Press the **STOP** button to stop playback.

5

Press the **REW(ind)** button to rewind the tape.

6

When the tape has finished rewinding, press the **EJECT** button to remove the tape.

1

Turn on the TV.

2

Insert a tape.

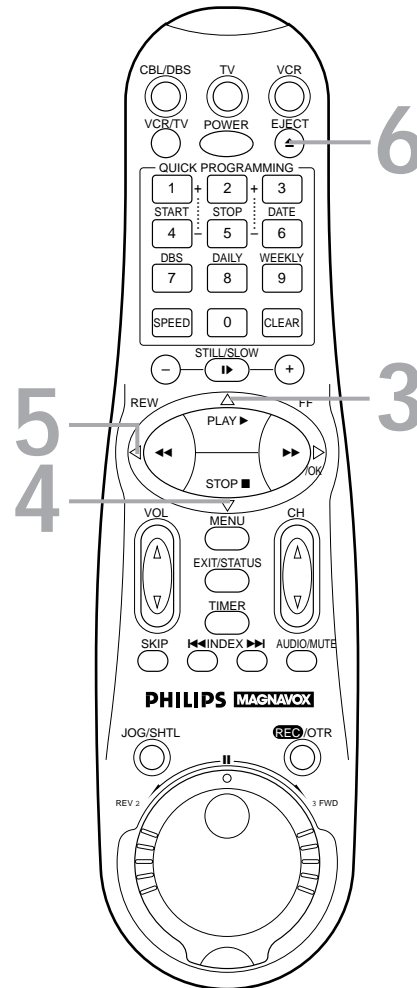

Helpful Hint

- Playback options and features are discussed on pages 43 - 50.
- This VCR is equipped with SQPB (S-VHS Quasi Playback) that lets you watch tapes recorded in the S-VHS format with regular VHS resolution.
 - SQPB does not deliver Super VHS resolution.
 - S-VHS recording is not possible with this VCR.

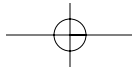

30 Recording

Read and follow the steps below to record a television program.

1

Turn on the TV and set it to channel 3 or 4, whichever the CH3/CH4 switch on the back of the VCR is set to.

2

Insert a tape with its record tab intact (details are on page 5) in the VCR. The power will come on.

3

Press the VCR button.

4

If the VCR light appears on the display panel of the VCR, go to step 5. If the VCR light does not appear, press the VCR/TV button once.

5

Press the SPEED button until the desired tape speed appears on-screen. The VCR will only record in SP or SLP. Details about tape speed are on pages 38 and 52.

6

Use the CH(annel) ▲/▼ buttons or the Number buttons to select the channel to be recorded.

7

Press the REC(ord)/OTR button to start recording. The ○ light will appear on the VCR display panel.

8

To pause the recording (for example, during commercials), press the STILL/SLOW button on the remote control. The ○□□ light will appear on the display panel.

To resume recording, press the STILL/SLOW button again. The ○ light will appear on the display panel.

9

Press the STOP ▼ button to stop recording. The ○ light will disappear from the display panel.

1

Turn on the TV.

2

Insert a tape.

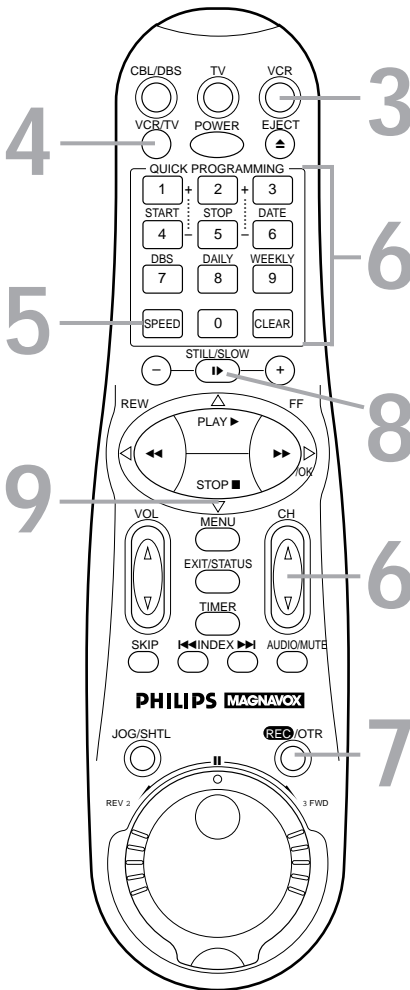

Helpful Hints

- If the REC(ord)/OTR button is pressed while a tape without a record tab is in the VCR, PROTECTED CASSETTE CANNOT RECORD will appear briefly on screen. The VCR will eject the tape.
- The VCR records in a preset volume.
- If the end of the tape is reached while recording, the VCR will stop recording, rewind the tape, then stop. Details are on page 51.

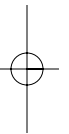
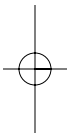

One-Touch Recording 31

The One-Touch Recording (OTR) function allows you to start an immediate timed recording 30 minutes to nine hours long of the channel you are watching. Before you begin, make sure:

- Channels are set up. *Details are on pages 11 - 12.*
- The desired recording speed (SP or SLP) has been selected with the SPEED button. *Details are on pages 38 and 52.*
- There is a tape in the VCR. Make sure the tape's record tab is intact (see page 5) and the tape is long enough to record the program(s). If the end of the tape is reached during an OTR, recording will stop. The VCR will eject the tape and turn itself off.
- The VCR is in VCR position. (The VCR light will appear on the display panel of the VCR when the VCR is in VCR position. If the VCR light does not appear, press the VCR/TV button once.)

Starting an OTR

1

Press the VCR button.

2

Use the CH(annel) ▲/▼ buttons or the Number buttons to select the channel you want to record.

3

Press the REC(ord)/OTR button repeatedly, until the desired recording length appears briefly on screen and on the display panel. The ○ light will flash on the display panel.

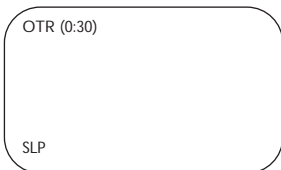

Stopping an OTR

To stop an OTR before recording is finished, press the STOP ▼ button.

To cancel the OTR but continue recording, press the REC(ord)/OTR button until REC appears in the upper left corner of the TV screen. (ON SCREEN MODE cannot be set to OFF. *Details are on page 26.*) The ○ light will remain on the display panel.

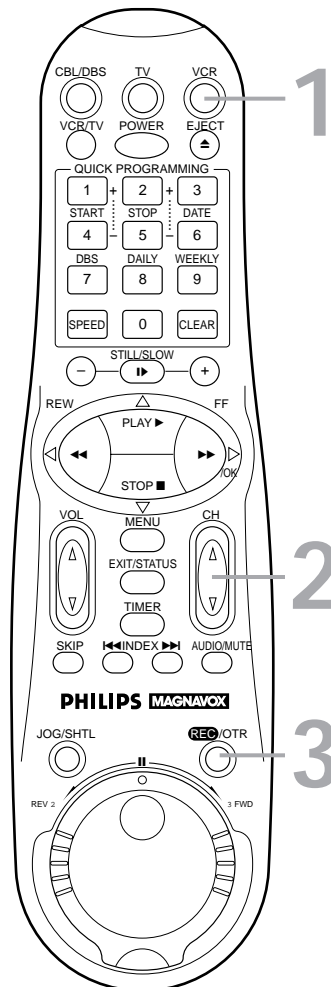

Helpful Hints

- To check the time remaining for an OTR after the OTR is in progress, press the EXIT/STATUS button.
- To change the recording length while an OTR is in progress, press the REC(ord)/OTR button until the desired length appears on screen.
- If the preset time for a timer recording comes up during an OTR, the OTR has priority.

32 Recording One Channel/Watching Another

1

Press the VCR button.

2

Press the REC(ord)/OTR button to start a recording.
Details are on page 30.

3

Press the VCR/TV button to put the VCR in TV position.
 The VCR light will disappear from the display panel.

4

Use the TV remote control to select the channel you want to watch. Or, if the VCR remote control operates your TV, press the TV button, then use the CH(annel) ▲/▼ buttons to select the channel you want to watch. The channel selected with the TV controls will appear on-screen while the channel you previously selected to record is being recorded. (The ○ light will appear on the display panel.)

5

To return to the channel being recorded, use the TV remote control to select channel 03 or 04 (whichever channel the CH3/CH4 switch on the back of the VCR is set to). Or, if the VCR remote control operates your TV, press the TV button, then use the CH(annel) ▲/▼ buttons to select channel 03 or 04.

6

Press the VCR button.

7

Press the VCR/TV button to put the VCR in VCR position. (The VCR light will appear on the display panel.) The channel being recorded will appear on-screen.

8

To stop the recording, press the STOP ▼ button.

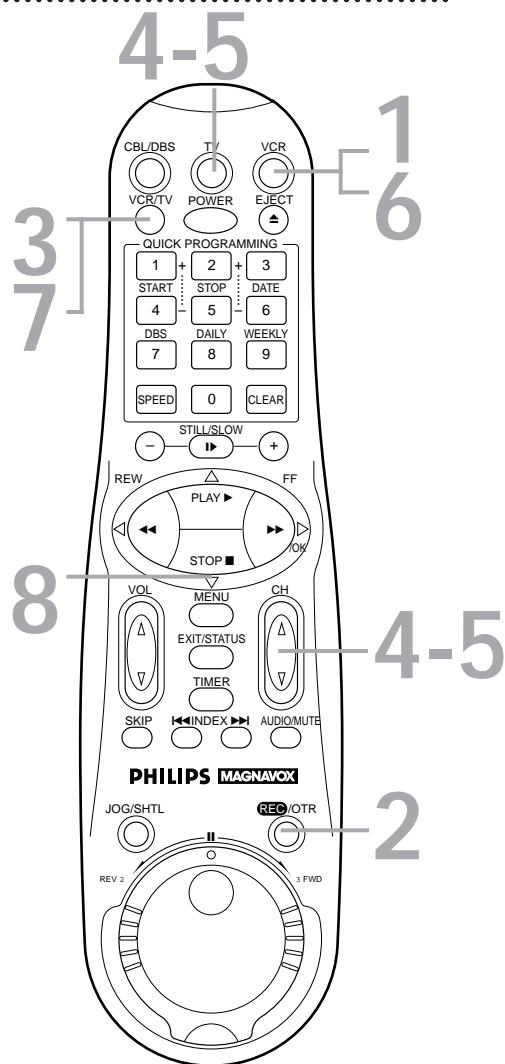

Helpful Hint

- If you use a Cable Box/DBS, you may not be able to watch one channel while recording another. See pages 8 - 9 for details.

34 Setting Up the VCR Plus+ Programming System (cont'd)

2

Now, compare the channel numbers you have written into the VCR PLUS+ CH. and CABLE/TV CH. columns. You'll notice that some stations have VCR Plus+ and Cable/TV channel numbers that are the same, and other stations have channel numbers that do not match. You must tell the VCR Plus+ and Cable/TV channel numbers according to the following steps.

3

Press the VCR button, then press the MENU button.

4

Press the PLAY ▲ or STOP ▼ button to select INITIAL SET UP, then press the FF ►/OK button.

5

Press the PLAY ▲ or STOP ▼ button to select VCR PLUS+ CH., then press the FF ►/OK button.

SET VCR PLUS+ CH.	VCR PLUS+ CH.	CABLE/TV
	99	---
	01	---
	02	---->
	03	---
	04	---

SELECT ▲▼ OR ENTER VCR+ CH. NO. THEN PUSH ►/OK TO END PUSH EXIT

6

While the VCR PLUS+ channel is flashing, press the PLAY ▲ or STOP ▼ button repeatedly or press the Number buttons to select a VCR PLUS+ channel number. The arrow will appear beside the VCR PLUS+ channel. Press the FF ►/OK button.

7

While the space for the CABLE/TV channel is flashing, press the PLAY ▲ or STOP ▼ button repeatedly or press the Number buttons to enter the CABLE/TV channel number. Press the FF ►/OK button.

Repeat steps 6 - 7 until you have entered all the channels on your list.

8

Press the EXIT/STATUS button.

2 Examine the lists on page 32.

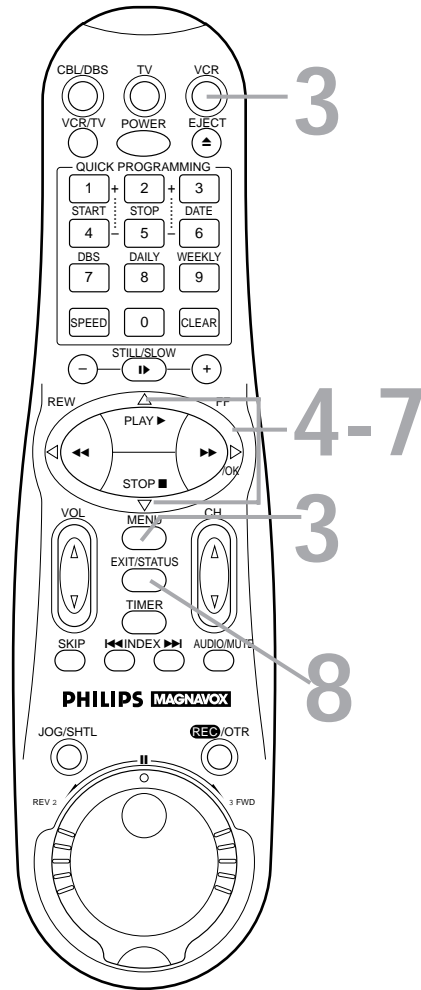

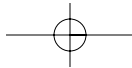

Timer Recording With the VCR Plus+ Programming System 35

Follow the steps below to program a timer recording using PlusCode programming numbers. Before you begin make sure:

- Channels are set up. *Details are on pages 11 - 12.*
- The clock is set. *Details are on pages 13 - 17.*
- There is a tape in the VCR. Make sure the tape's record tab is intact and the tape is long enough to record the program(s).
- The VCR is in VCR position (the VCR light will appear on the display panel). If the VCR light does not appear, press the VCR/TV button once.
- You have programmed the VCR Plus+ and Cable/TV channel numbers. *Details are on pages 33 - 34.*

Complete each step within 60 seconds of completing the previous step. If you don't, you may start again at step 1.

1

Press the VCR button.

2

Press the TIMER button.

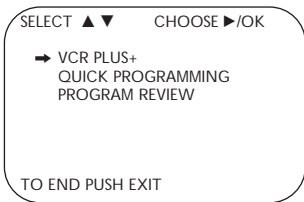

3

Press the PLAY ▲ or STOP ▼ button to select VCR PLUS+, then press the FF ►/OK button.

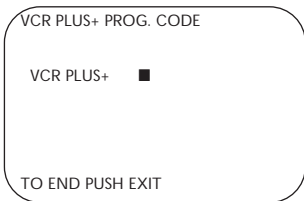

4

Use the Number buttons to enter the PlusCode programming number of the program you wish to record. (This number is different for every program, and it can be four to eight digits long.)

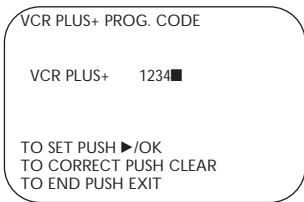

Instructions continue on page 36.

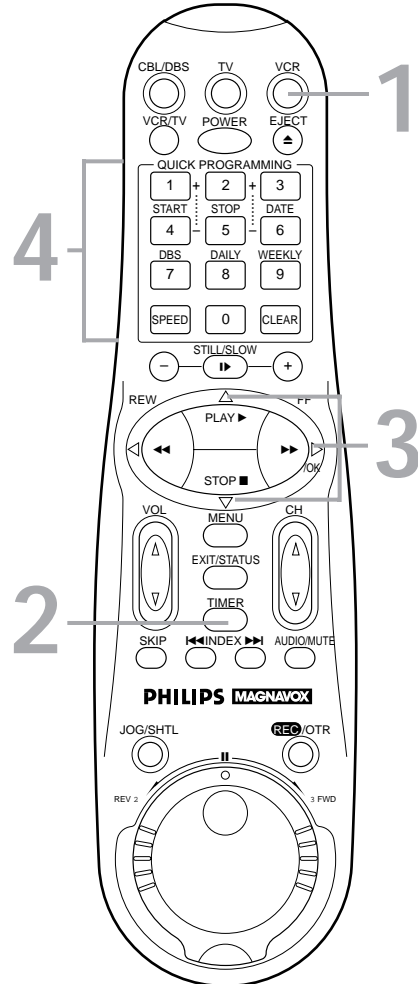

Helpful Hint

- If you enter an incorrect PlusCode programming number at step 4, ERROR-RE-ENTER CODE will flash on-screen. Enter the correct PlusCode programming number.

36 Timer Recording With the VCR Plus+ Programming System (cont'd)

5

Press the **FF ►/OK** button. If the VCR PLUS+ and CABLE/TV channel lists appear on screen, the CABLE/TV channel has not been set for the VCR PLUS+ channel of the program you have set in step 4. Complete steps 6 - 7 on page 34.

6

- If you want to record the program one time only, go to step 7. You may also press the Number 8/DAILY or 9/WEEKLY button repeatedly to select a ONE TIME PROGRAM.
- If you want to record the program daily, press the **Number 8/DAILY** button. The VCR will record a program every day from Monday through Friday, starting at the same time and recording for the same length of time.
- If you want to record the program every week, press the **Number 9/WEEKLY** button. The VCR will record a program on the same day, at the same time, for the same length of time every week.

DAILY PROGRAM (MON-FRI)	
PROGRAM	1
CHANNEL +/-	12
START +/-	08:00 PM
STOP +/-	10:00 PM
REC SPEED	SP
DATE +/-	07/31/98
	FRIDAY
SET DAILY=8 OR WEEKLY=9	
TO END PUSH EXIT	



7

Press the **SPEED** button to select the tape speed. The selected tape speed, SP or SLP, will appear beside REC SPEED.

8

Press the **EXIT/STATUS** button. PROGRAM WAS COMPLETED/PLEASE TURN OFF VCR FOR TIMER RECORDING should appear on the screen. (If PROGRAM NOT COMPLETED appears, begin again from step 1.) After five seconds, the on-screen display will disappear.

9

Press the **POWER** button to turn off the VCR. The VCR must be turned off for a timer recording to take place. The  light will appear on the display panel. The  light and the Cassette-Inside light will flash when you turn off the VCR if there is not a tape in the VCR.

**The VCR must be off for a timer recording to take place!
Make sure a tape is in the VCR.**

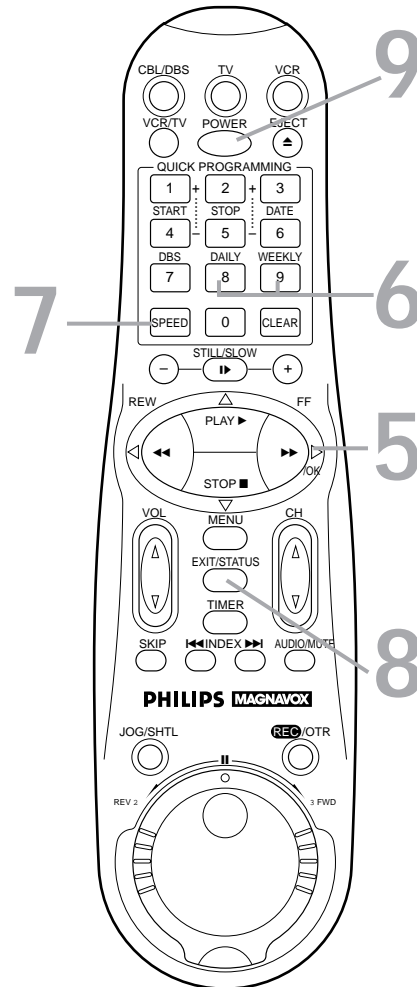

Helpful Hints

- Do not select DAILY at step 6 if the VCR Plus+ recording you chose is on a Saturday or Sunday. The recording will not occur, even though the VCR may accept the way you programmed the recording.
- To exit the VCR Plus+ programming system at any step, press the EXIT/STATUS button.
- PROGRAM NOT COMPLETED/CLASH may appear on-screen for five seconds at step 8 if the timer recording you programmed overlaps with another timer recording. To cancel the overlapping timer recording, follow the steps on page 40.



Quick Programming 37

Follow the steps below to program your VCR to record TV programs while you're away from home. The VCR will turn itself on, record, and turn itself off automatically.

Before you begin make sure:

- Channels are programmed. *Details are on pages 11 - 12.*
- The clock is set. *Details are on pages 13 - 17.*
- There is a tape in the VCR. Make sure the tape's record tab is intact and the tape is long enough to record the program(s).
- The VCR is in VCR position. The VCR light will appear on the display panel when the VCR is in VCR position. If the VCR light does not appear, press the VCR/TV button once.
- When you use a Cable Box/DBS, timer recordings are programmed differently. Read pages 8 - 9 before proceeding.
- Complete each step within 60 seconds of the previous step.

1

Press the VCR button, then press the TIMER button.

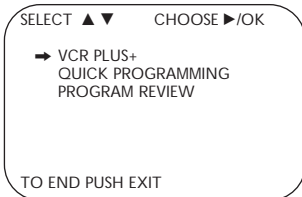

2

Press the PLAY ▲ or STOP ▼ button to select QUICK PROGRAMMING, then press the FF ►/OK button.

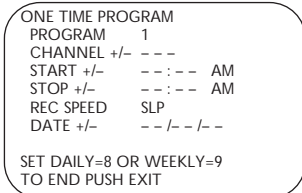

3

Press the CH(annel) ▲/▼ buttons to enter the channel you want to record.

- If you are using a standard antenna or cable to VCR to TV hookup (as shown on pages 6 - 7), enter the channel of the TV program you want to record.
- If you are using a Cable Box/DBS, enter the Cable Box/DBS output channel (03 or 04). Leave the Cable Box/DBS on for a timer recording.

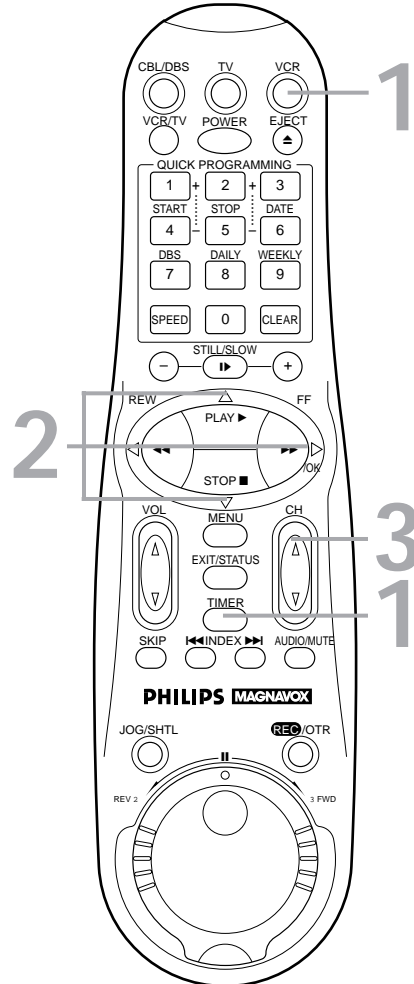
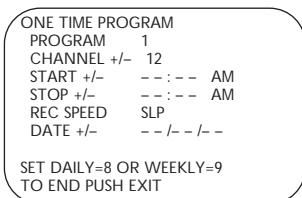

Instructions continue on page 38.

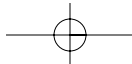

38 Quick Programming (cont'd)

4

Press the Number 1/START + or Number 4/START- button to set the recording's start time. Every time you press a button, the start time changes in one-minute increments. If you press and hold a button, the start time changes in 30-minute increments.

ONE TIME PROGRAM
 PROGRAM 1
 CHANNEL +/- 12
 START +/- 08:00 PM
 STOP +/- --:-- AM
 REC SPEED SLP
 DATE +/- --/--/--

SET DAILY=8 OR WEEKLY=9
 TO END PUSH EXIT

5

Press the Number 2/STOP+ or Number 5/STOP- button to set the recording's stop time. Every time you press a button, the stop time changes in one-minute increments. If you press and hold a button, the stop time changes in 30-minute increments.

ONE TIME PROGRAM
 PROGRAM 1
 CHANNEL +/- 12
 START +/- 08:00 PM
 STOP +/- 10:00 PM
 REC SPEED SLP
 DATE +/- --/--/--

SET DAILY=8 OR WEEKLY=9
 TO END PUSH EXIT

6

Press the SPEED button to select the tape speed (SP or SLP). Details about tape speed are given below.

ONE TIME PROGRAM
 PROGRAM 1
 CHANNEL +/- 12
 START +/- 08:00 PM
 STOP +/- 10:00 PM
 REC SPEED SLP
 DATE +/- --/--/--

SET DAILY=8 OR WEEKLY=9
 TO END PUSH EXIT

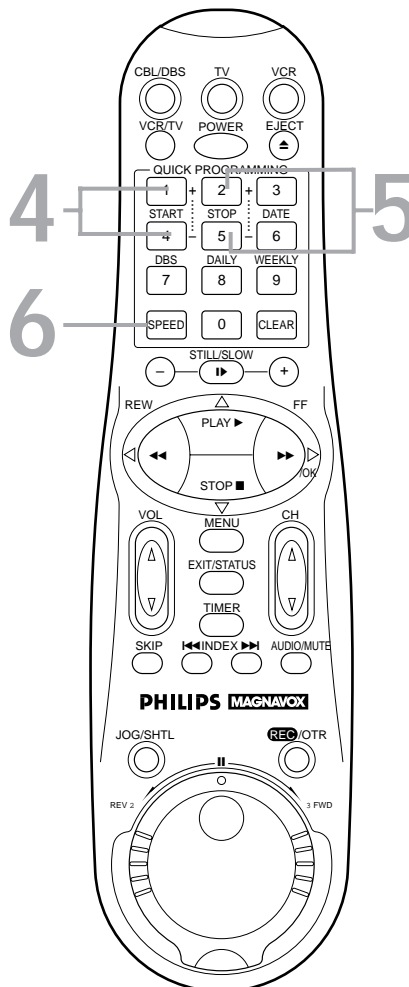

Instructions continue on page 39.

Tape Speeds	Tape Speed	Maximum Record/Playback Time		
		T160	T120	T60
This chart shows the recording/playback time for T160, T120, and T60 video cassettes. There are three playback speeds: SP, LP, and SLP. This VCR will play tapes recorded in LP, but LP will not appear on the display panel. This VCR will only record in SP and SLP.	SP (Standard Play)	2 hrs. 40 mins.	2 hrs.	1 hr.
	LP (Long Play)	5 hrs. 20 mins.	4 hrs.	2 hrs.
	SLP (Super Long Play)	8 hrs.	6 hrs.	3 hrs.

Quick Programming (cont'd) 39

7

Press the Number 3/DATE+ or Number 6/DATE- button to set the recording date. Every time you press a button, the date changes in one-day increments. If you press and hold a button, the date changes quickly. The day of the week will appear automatically. (You cannot program the VCR to record more than one year in advance.)

ONE TIME PROGRAM
 PROGRAM 1
 CHANNEL +/- 12
 START +/- 08:00 PM
 STOP +/- 10:00 PM
 REC SPEED SLP
 DATE +/- 07/31/98
 FRIDAY
 SET DAILY=8 OR WEEKLY=9
 TO END PUSH EXIT

8

- If you want to record the program one time only, go to step 9. You may also press the Number 8/DAILY or 9/WEEKLY button repeatedly to select a ONE TIME PROGRAM.
- If you want to record the program daily, press the Number 8/DAILY button. The VCR will record a program every day from Monday through Friday, starting at the same time and recording for the same length of time.
- If you want to record the program every week, press the Number 9/WEEKLY button. The VCR will record a program on the same day at the same time and for the same length of time, every week.

DAILY PROGRAM (MON-FRI)
 PROGRAM 1
 CHANNEL +/- 12
 START +/- 08:00 PM
 STOP +/- 10:00 PM
 REC SPEED SLP
 DATE +/- 07/31/98
 FRIDAY
 SET DAILY=8 OR WEEKLY=9
 TO END PUSH EXIT

9

Press the EXIT/STATUS button. PROGRAM WAS COMPLETED/PLEASE TURN OFF VCR FOR TIMER RECORDING will appear on-screen. If PROGRAM NOT COMPLETED appears, try again from step 1.

10

Press the POWER button to turn off the VCR. The \odot light will appear on the display panel. (The \odot light and the Cassette Inside light will flash when you turn off the VCR if there is not a tape in the VCR.) The VCR must be turned off for a timer recording to take place. If you forget to turn off the VCR, PLEASE TURN OFF VCR FOR TIMER RECORDING flashes on your TV screen two minutes before a timer recording starts. To remove the message, press the CLEAR button.



Helpful Hints

- If the preset time for a timer recording comes up during a One-Touch Recording, the OTR has priority.
- If you leave the VCR on past the scheduled start time of a timer recording, you will not be asked again to turn off the VCR. When you turn off the VCR, the timer recording will not take place. The VCR may reprogram the recording for the same day and time in the next year.
- If the end of the tape is reached during a timer recording, recording will stop. The VCR will eject the tape, then turn itself off.
- If PROGRAM NOT COMPLETED/CLASH appears at step 9, the timer recording you just programmed overlaps another timer recording. The time recording you just programmed will not take place. The time recording menu will reappear. To cancel a timer recording, see page 40.

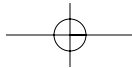

40 Quick Programming (cont'd)

Checking, Editing, or Clearing Timer Recordings

1

Press the VCR button, then press the TIMER button.

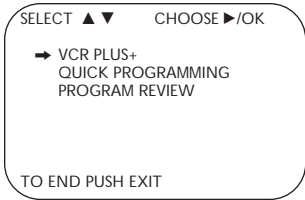

2

Press the PLAY ▲ or STOP ▼ button to select PROGRAM REVIEW, then press the FF ►/OK button. The list of programmed timer recordings will appear.

PR	CH	START	STOP	DATE
1	12	08:00P	10:00	D07/31
2	36	10:00A	10:45	08/01
3	24	11:30P	01:00	08/10
4	45	03:00P	03:15	W10/15
5				
6				
7				
8				

NEXT=► END=EXIT

← D indicates a Daily recording.

← W indicates a Weekly recording.

3

Press the FF ►/OK button. Information for the first program will appear. (If no timer recordings are set, NO PROGRAM SET will appear briefly.)

ONE TIME PROGRAM	
PROGRAM	1
CHANNEL +/-	12
START +/-	08:00 PM
STOP +/-	10:00 PM
REC SPEED	SLP
DATE +/-	07/31/98
	FRIDAY
TO ERASE PROGRAM = CLEAR	
NEXT = ►	PREV = ◀
END = EXIT	

4

Press the FF ►/OK button repeatedly to review all programmed timer recordings. Or, press the REW(ind) ◀ button to return to the previous screen.

5

You may change any of the information, except the program number. Follow the steps on pages 37 - 39.

6

To cancel the timer recording, press the CLEAR button. You will either see the next timer recording or the menu will disappear.

7

Press the EXIT/STATUS button.

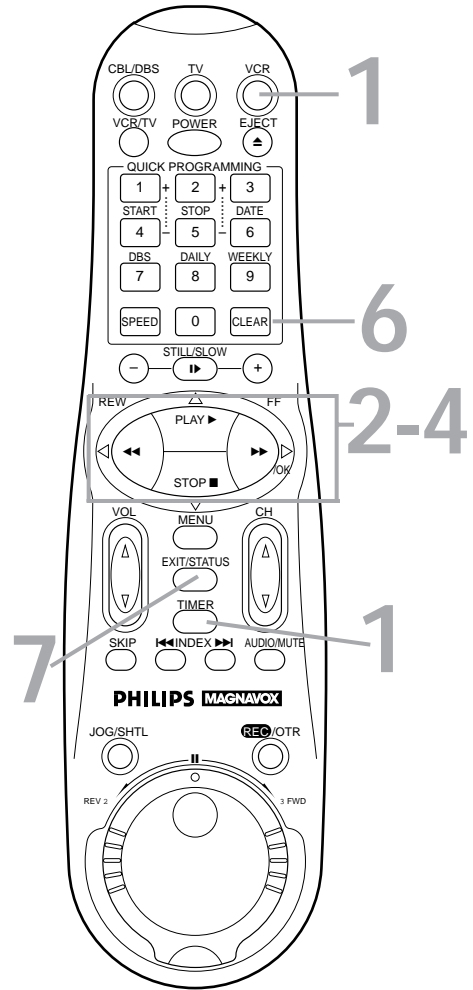

Helpful Hint

- To stop a started timer recording, press the POWER button on the VCR.
- See pages 54 - 55 for more hints.

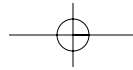

Timer Recording Speed Setting 41

.....

If a program is recorded in SP and there is not enough tape to record the entire program, the VCR automatically switches to SLP to allow complete recording if **TIMER REC SPEED** is set to **AUTO**. This feature is especially useful when you record a program that is more than two hours long.

For example, to record a program of 140 minutes in length onto a 120-minute tape, the program is recorded in SP for about 110 minutes and in SLP for about 30 minutes.

Approximately 110 minutes	Approximately 30 minutes
SP	SLP

Follow the steps below to set **TIMER REC SPEED** to **AUTO**.

1

Press the **VCR** button, then press the **MENU** button.

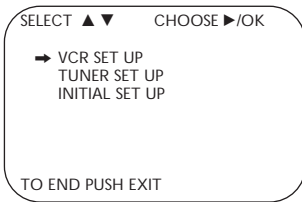

2

Press the **PLAY ▲** or **STOP ▼** button to select **VCR SET UP**, then press the **FF ►/OK** button.

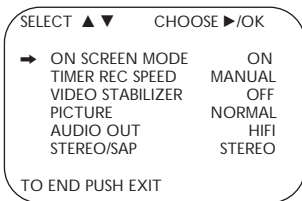

3

Press the **PLAY ▲** or **STOP ▼** button to select **TIMER REC SPEED**, then press the **FF ►/OK** button so that **AUTO** appears beside **TIMER REC SPEED**.

4

Press the **EXIT/STATUS** button.

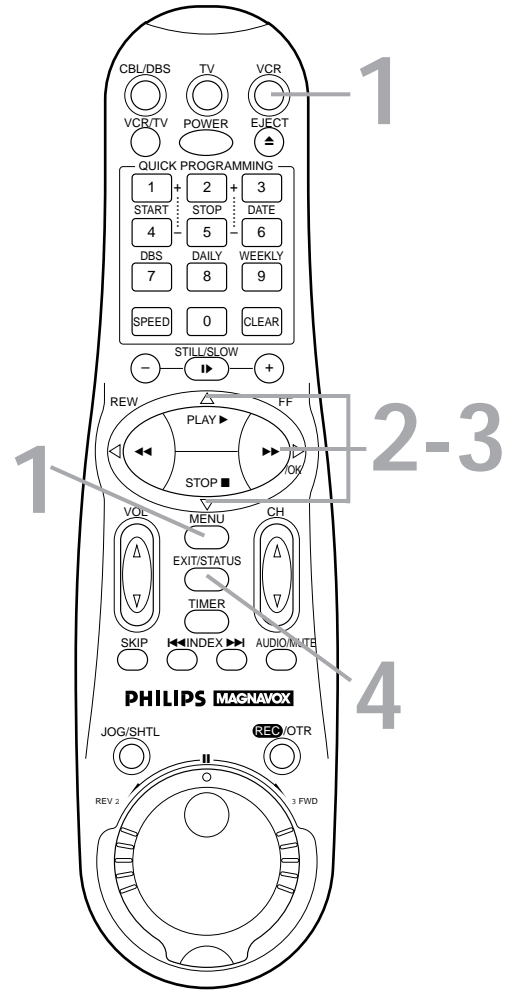



42 Rerecording (Tape Duplication)

The instructions on this page show you how to copy tapes. The illustration uses two VRZ364 VCRs. Different VCRs may operate differently. To duplicate a tape, make the connections shown, then follow steps 1 - 6. (You may use the AUDIO and VIDEO In jacks on the front of VCR 2 instead if you prefer.)

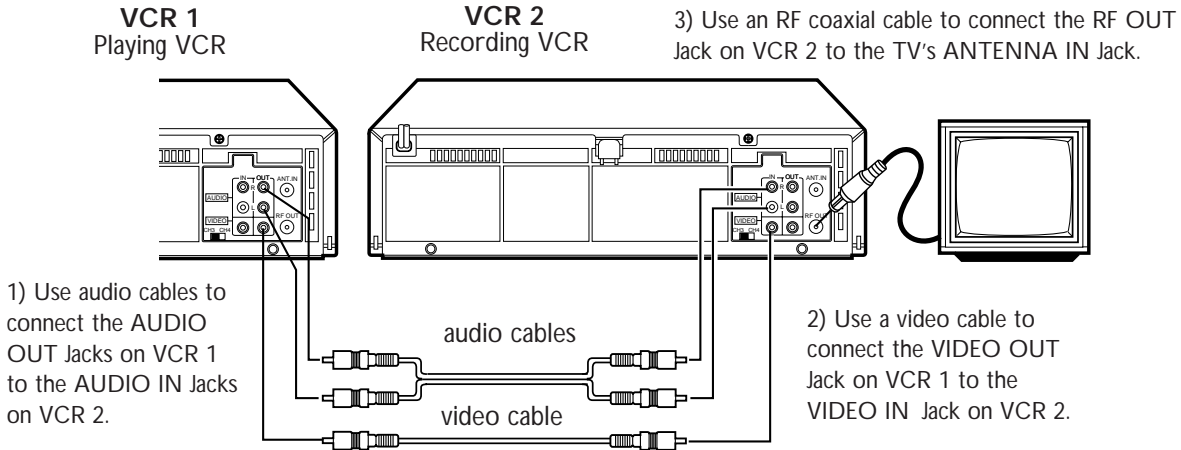

1

VCR 1 will play your tape. **Insert a prerecorded tape in VCR 1.** If the tape does not have a record tab, playback begins. If this happens, press the STOP/EJECT button on VCR 1 once.

2

VCR 2 will record your tape. **Insert a blank tape in VCR 2. Make sure the VCR power is on and the VCR is in VCR position.** (The VCR light will appear on the display panel. If it does not, press the VCR/TV button once.)

3

Turn on the TV; set it to channel 3 or 4, whichever channel the CH3/CH4 switch on VCR 2 is set to.

4

Point the remote control at VCR 2. Press the VCR button, then press the Number buttons 0, 0. L-1 will appear on the display panel.

5

Point the remote control at VCR 2. Press the SPEED button to select SP or SLP.

6

Press the PLAY button on VCR 1 and the REC(ord)/OTR button on VCR 2 at the same time. The \odot light will appear on the VCR 2 display panel.

Helpful Hints

- *Unauthorized recording of copyrighted television programs, video tapes, or other materials may infringe on the rights of copyright owners and violate copyright laws.*
- *Audio and video cables are not included.*
- *The VCR in the figure above is the VRZ364. If you have the VRZ344, use a single-plug audio cable to connect the AUDIO OUT Jack on VCR 1 to the AUDIO IN Jack on VCR 2.*
- *To stop copying tapes, press the STOP/EJECT button on VCR 2, then press the STOP/EJECT button on VCR 1.*
- *If you connect the audio and video cables to the AUDIO/VIDEO In jacks on the front of VCR 2, you must select A/V IN FRONT at step 4. To do so, press Number buttons 0,0, then press the CH(annel) ▼ button so that A/V IN FRONT appears on-screen and L-F appears on the display panel.*

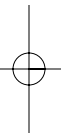
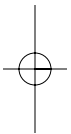

Index Search 43

When you make a recording, the VCR automatically places an index code at the beginning of the recording. Essentially, an index code is a type of "bookmark" for your tape. This feature is useful if you have several different programs recorded on a single tape.

Fast forward or rewind to the next or previous index code on the tape by following the steps below.

1

Press the VCR button.

2

Make sure the VCR is in VCR position. (The VCR light will appear on the display panel when the VCR is in VCR position.) **If the VCR light does not appear, press the VCR/TV button once.**

3

Insert a tape in the VCR.

4

Press the STOP ▼ button to stop tape playback, if necessary.

5

Press the INDEX ►► button to fast forward to the next index code on the tape. Or, press the INDEX ◄◄ button to rewind to the previous index code on the tape. Wait for the VCR to fast forward or rewind the tape. When the index code is reached, tape playback will begin automatically.

NOTE: You may press an INDEX button repeatedly to skip over multiple recordings. For example, if you want to fast forward past four recordings, press the INDEX ►► button four times. INDEX 4 will appear in the bottom right corner of the screen.

3 Insert a tape.

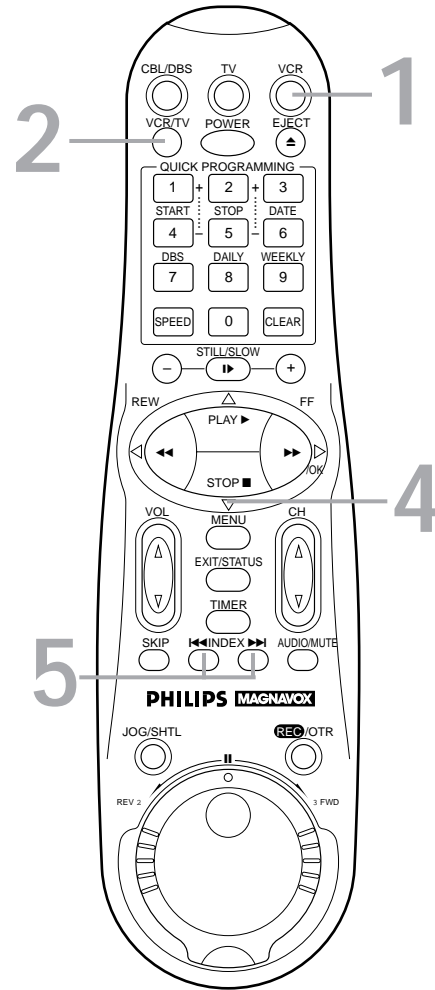

Helpful Hints

- The VCR does not place an index code at the point where a recording is paused, then resumed.
- INDEX may flash briefly on screen when you begin a recording.



44 Multi-Channel Television Sound System (VRZ364 only)

Your VCR can receive and record programs broadcast in stereo or second audio. It can also play back tapes recorded in stereo or second audio.

- **Second Audio** You can program your VCR so that you can hear a program that is being broadcast in second audio or a tape that was recorded in second audio. (A second audio broadcast is usually a program in a second language.) Follow the steps on page 45 to receive or record this type of program.
- **Hi-Fi Stereo Playback** If a tape is recorded in stereo, you can program your VCR to play a tape in Hi-Fi (high fidelity) stereo. Follow the steps on page 46.
- **Hi-Fi Stereo Recording** If a TV program is broadcast in stereo, you can program your VCR to receive and record the program in Hi-Fi stereo. You must program the VCR and make the appropriate stereo hookups. Follow the steps on page 45. To playback this type of program, follow the steps on page 46.

Receiving a Stereo Broadcast

When a TV program is being broadcast in stereo, STEREO will appear in the status display. You still have to program your VCR to receive and record the stereo broadcast. Follow the steps on page 45.



Receiving a Second Audio Program

If a program is being broadcast in second audio, SAP (Second Audio Program) will appear in the status display. You still have to program your VCR to receive and record the second audio program. Follow the steps on page 45.





Multi-Channel Television Sound System (VRZ364 only) (cont'd) 45

To receive and record programs broadcast in second audio, follow steps 1 - 6. To receive and record a program broadcast in stereo, make one of the connections shown, then follow steps 1 - 6.

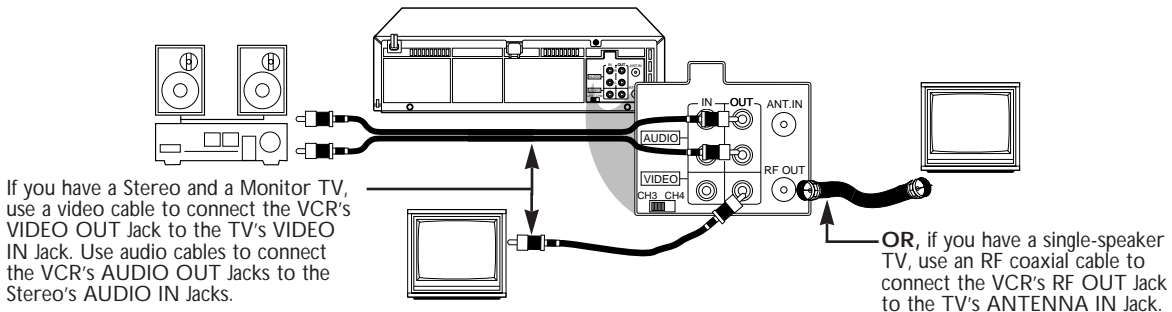

1

Press the VCR button, then press the MENU button.

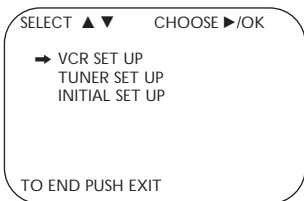

2

Press the PLAY ▲ or STOP ▼ button to select VCR SET UP, then press the FF ►/OK button.

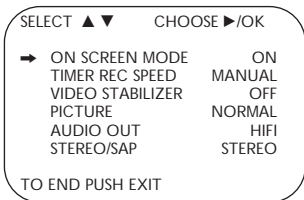

3

Press the PLAY ▲ or STOP ▼ button to select STEREO/SAP, then press the FF ►/OK button to select SAP or STEREO, whichever you prefer.

4

Press the EXIT/STATUS button.

5

Use the CH(annel) ▲/▼ buttons to select a channel.

6

Press the SPEED button to select the tape speed.

7

Press the REC(ord)/OTR button to start recording.

Helpful Hints

- If you want to connect the VCR to a Stereo TV, follow these steps.
 - 1) Connect the antenna or cable signal to the VCR's ANT(enna) IN Jack.
 - 2) Use stereo audio cables to connect the VCR's AUDIO OUT Jacks to the TV's AUDIO IN Jacks.
 - 3) Use a video cable to connect the VCR's VIDEO OUT Jack to the TV's VIDEO IN Jack.
- Make sure the TV and the Stereo (if applicable) are in Line Input or Auxiliary mode. Please refer to your TV or Stereo owner's manual for details.

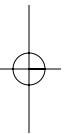
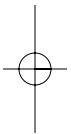

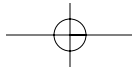

46 Hi-Fi Stereo Tape Playback (VRZ364 only)

If a tape is recorded in Hi-Fi stereo, follow the steps below to play the tape in Hi-Fi stereo.

1

Press the VCR button, then press the MENU button.

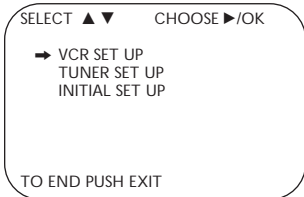

2

Press the PLAY ▲ or STOP ▼ button to select VCR SET UP, then press the FF ►/OK button.

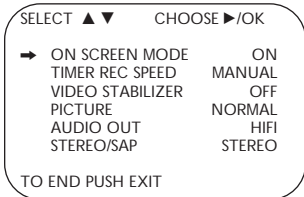

3

Press the PLAY ▲ or STOP ▼ button to select AUDIO OUT, then press the FF ►/OK button to select HIFI.

4

Press the EXIT/STATUS button.

5

Press the PLAY ▲ button to start tape playback.

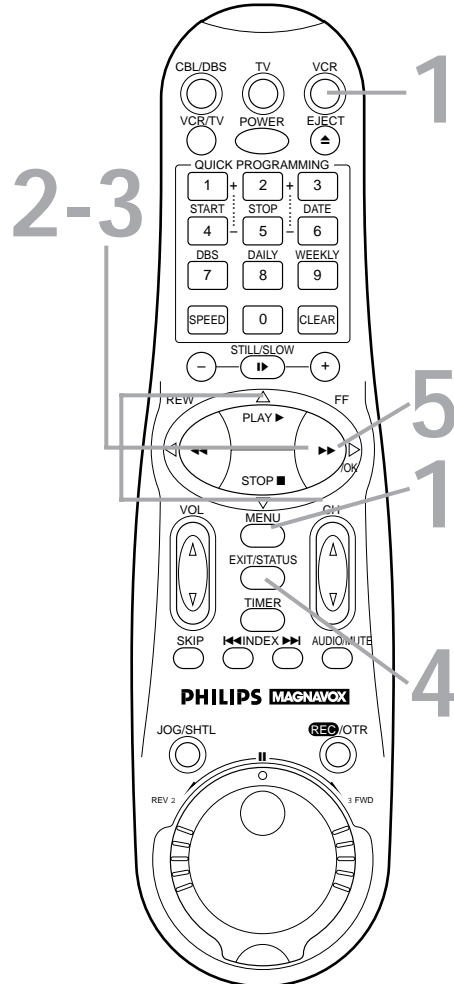

Helpful Hints

- During playback, Hi-Fi stereo may temporarily revert to normal audio when you adjust tracking. This is normal.
- If Hi-Fi stereo continually reverts to normal audio during playback, you may want to press the FF ►/OK button to select MONO at step 3.
- Only tapes recorded in Hi-Fi stereo will play in Hi-Fi stereo. Tapes recorded in normal audio will play in normal audio.
- You may also select HIFI or MONO by repeatedly pressing the AUDIO/MUTE button on the remote control.

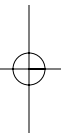
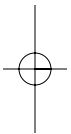

Video Stabilizer 47

You can correct vertical vibration when playing back tapes recorded in SLP speed. When VIDEO STABILIZER is set to ON, vertical vibration will be corrected automatically. VIDEO STABILIZER is set to OFF when you receive the VCR.

Follow the steps below to set VIDEO STABILIZER to ON.

1

Press the VCR button, then press the MENU button.

SELECT ▲▼	CHOOSE ►/OK
→ VCR SET UP	
TUNER SET UP	
INITIAL SET UP	
TO END PUSH EXIT	

2

Press the PLAY ▲ or STOP ▼ button to select VCR SET UP, then press the FF ►/OK button.

SELECT ▲▼	CHOOSE ►/OK
→ ON SCREEN MODE	ON
TIMER REC SPEED	MANUAL
VIDEO STABILIZER	OFF
PICTURE	NORMAL
AUDIO OUT	HIFI
STEREO/SAP	STEREO
TO END PUSH EXIT	

3

Press the PLAY ▲ or STOP ▼ button to select VIDEO STABILIZER, then press the FF ►/OK button so that ON appears beside VIDEO STABILIZER.

SELECT ▲▼	CHOOSE ►/OK
ON SCREEN MODE	ON
TIMER REC SPEED	MANUAL
→ VIDEO STABILIZER	ON
PICTURE	NORMAL
AUDIO OUT	HIFI
STEREO/SAP	STEREO
TO END PUSH EXIT	

4

Press the EXIT/STATUS button.

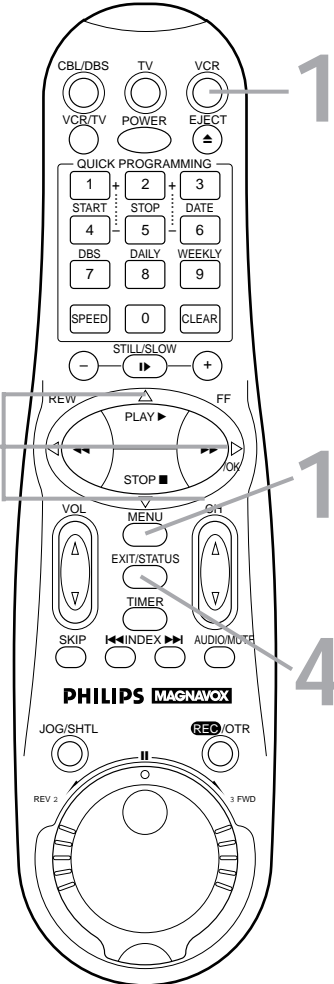

Helpful Hints

- Regardless of the setting, this function has no effect on tapes recorded in SP speed, during recording, and during special effects playback.
- To set VIDEO STABILIZER to OFF, follow steps 1 - 2 above. At step 3, press the FF ►/OK button so that OFF appears beside VIDEO STABILIZER. Press the EXIT/STATUS button.
- The on screen status display may jitter vertically when VIDEO STABILIZER is set to ON.

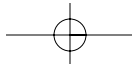

48 Incredible Picture

You can make the picture sharper or enhance a picture when playing back tapes recorded in SLP speed. PICTURE is set to NORMAL when you receive the VCR. Follow the steps below to set PICTURE to INCREDIBLE or ENHANCER.

1

Press the VCR button, then press the MENU button.

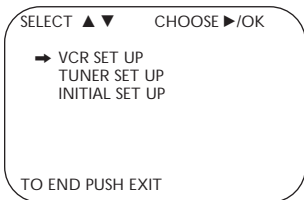

2

Press the PLAY ▲ or STOP ▼ button to select VCR SET UP, then press the FF ►/OK button.

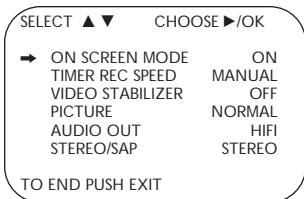

3

Press the PLAY ▲ or STOP ▼ button to select PICTURE, then press the FF ►/OK button repeatedly to select ENHANCER for an enhanced picture or INCREDIBLE for a sharper picture.

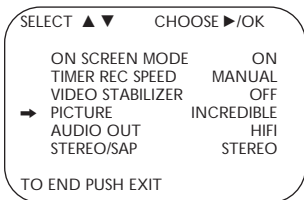

4

Press the EXIT/STATUS button.

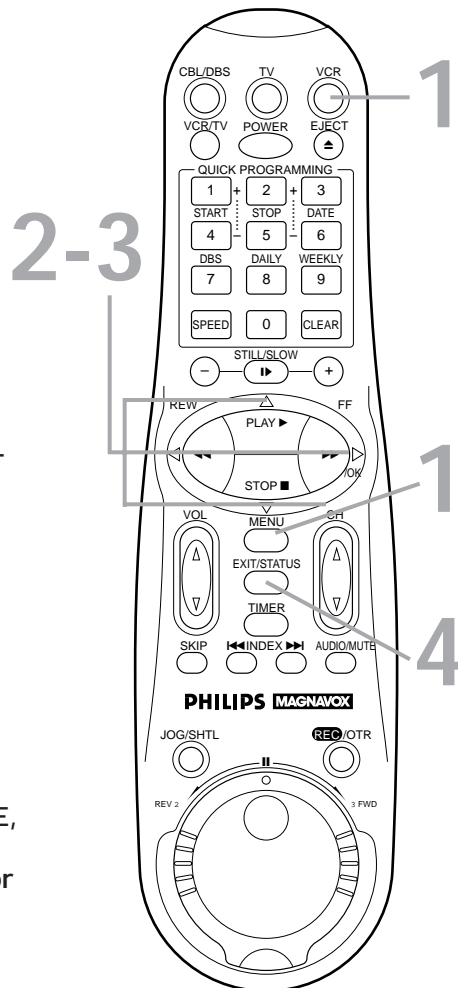

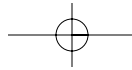

Playback Options 49

Forward and Reverse Searching

1

During tape playback, press and release the **FF ►/OK** button or the **REW(ind) ◀** button. A fast forward or reverse picture search will begin.

2

To return to playback, press the **PLAY ▲** button.

Viewing a Still Picture

1

During tape playback, press the **STILL/SLOW** button. A still picture will appear on screen.

2

To advance the still picture frame-by-frame, press the **STILL/SLOW** button repeatedly.

3

To return to playback, press the **PLAY ▲** button.

Viewing a Slow Motion Picture

1

During tape playback, press and hold the **STILL/SLOW** button for three seconds. The tape will play in slow motion.

2

Press the **STILL/SLOW -/+** buttons to adjust the speed of slow motion playback.

3

To return to playback, press the **PLAY ▲** button.

Repeat Playback

1

Press and hold the **PLAY ▲** button until the **▷** light flashes on the display panel. Now, when a tape has finished playing, the VCR will rewind it and start playback again. The VCR will play the tape 50 times. The **▷** light on the display panel will flash during tape playback and while rewinding. TV programming will appear while the tape is rewinding.

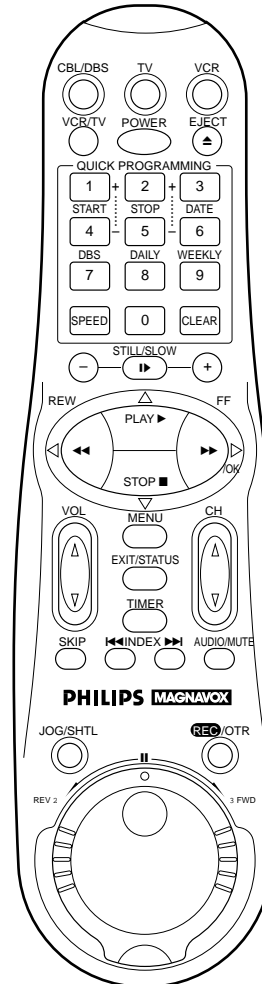

Helpful Hints

- During Search, Slow, and Still modes, there will be no sound.
- Slow and Still modes automatically switch to Stop mode after five minutes to protect the VCR and the tape from damage.
- During Forward or Reverse Searching, noise bars will appear on screen.
- You may only view a tape in Slow Motion if the tape is recorded in SP or SLP speed.

50 Playback Options (cont'd)

Viewing Pictures in Slow to Fast Motion

1

First, press the JOG/SHTL (shuttle) button while in the Play or Still mode. The JOG/SHUTTLE button will light.

2

Next, turn the outer ring (the Shuttle ring) in either direction. The farther the ring is rotated, the faster the search speed. Releasing the ring stops the picture in the Still mode.

3

Or, turn the inner dial (the Jog Dial) in either direction. The tape will move frame-by-frame at the speed with which the dial is turned.

4

Press the PLAY button to release the Still mode.

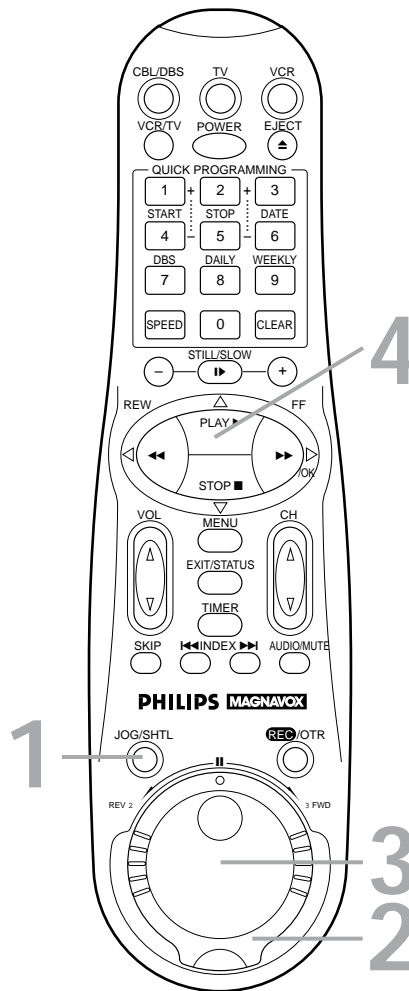

Helpful Hints

- The Jog/Shuttle Light goes off after 60 seconds if no buttons are pressed.

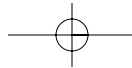

Automatic Operation Features 51

Automatic Playback

When you put a tape in the VCR, the power will come on automatically. If the tape's record tab is missing, playback will begin.

Automatic Rewind

When a tape is played, fast forwarded, or recorded to its end, the VCR will rewind the tape to the beginning, then stop.

Memory Rewind, Power Off

When the POWER button is pressed while the VCR is rewinding a tape, REWIND→POWER OFF will appear on screen. When the tape has finished rewinding, the VCR will stop, then turn itself off.

Tape Eject

A tape can be ejected with the VCR power on or off (but the VCR must be plugged in).

If a timer recording is programmed, the ⊖ and Cassette Inside lights will flash on the VCR's display panel when you eject a tape with the VCR power turned off.

Counter Reset

The counter will automatically reset to 0:00:00 when you insert a cassette.

To reset the counter to 0:00:00 at anytime, press the CLEAR button on the remote control.

Automatic Tracking Adjustment

The VCR continually adjusts tracking to give you the best possible picture quality. With some recordings, however, you may get a better picture by adjusting the tracking manually (see below).

Manual Tracking Adjustment

- Press the CHANNEL ▲/▼ buttons **on the VCR** to remove jitter in a still picture.
- You can return to Automatic Tracking Adjustment by pressing the CHANNEL ▲/▼ buttons **on the VCR at the same time**.
- The CHANNEL ▲/▼ buttons **on the VCR** also adjust tracking during normal tape playback.
- The VCR returns to Automatic Tracking Adjustment whenever a tape is inserted.

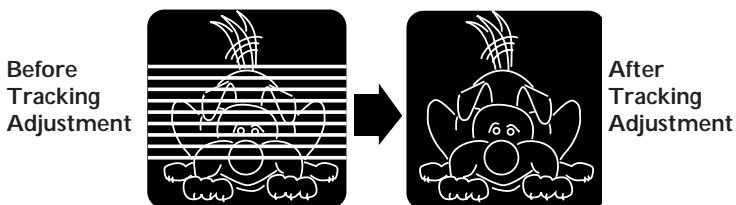



52 Glossary

AUDIO IN/OUT Jacks: jacks located on the front and back of the VCR which are used to record audio from another source (IN) or to send audio to another source (OUT). The VRZ344 has single AUDIO IN/OUT Jacks on the front and back of the VCR. The VRZ364 has Right and Left AUDIO IN/OUT Jacks on the front and back of the VCR.

Automatic Channel Programming: process in which the VCR scans all available channels and places the ones you receive in its memory. Then, when you press the CH(annel) ▲/▼ buttons, you only scan through channels you receive.

Bands: settings that allow you to tune channels.

- **Antenna** – VHF (very high frequency; channels 2 - 13) and UHF (ultra high frequency; channels 14 - 69).
- **Cable** – standard channels can be received without a Cable Box.

Cable Box/DBS Output Channel: channel 03 or 04.

DBS: Direct Broadcast System.

Dubbing: copying a tape using a second VCR.

Frame: a single still picture.

HQ: high quality; a feature in the VCR circuitry which provides enhanced picture detail.

OTR: one-touch recording; programming a timer recording that starts immediately and records for 30 minutes to nine hours, whichever you specify.

Remote Control: the small electronic unit that came with your VCR; allows you to operate your VCR from a distance. The remote control may also operate some features of your TV, Cable Box, or DBS.

RF coaxial cable: the cable supplied with your VCR. Use it to connect your VCR to your TV (or Cable Box/DBS, if applicable). The supplied cable is a snap-on type. However, you may also use a screw-on type if you prefer.

Special Effects: forward and reverse searching; viewing a still picture; or viewing a slow motion picture.

Tape Speeds: how fast the tape travels during a recording or playback.

- **LP (long play)** – average tape speed (playback time for a T120 tape is approximately four hours); available for playback only. Although the VCR will play tapes recorded in LP, LP will not appear on the display panel or in the on-screen status display.
- **SLP (super long play)** – slowest tape speed (recording/playback time for a T120 tape is approximately six hours).
- **SP (standard play)** – fastest tape speed (recording/playback time for a T120 tape is approximately two hours); best picture quality.

VCR: video cassette recorder.

VIDEO IN/OUT Jacks: jacks located on the front and back of the VCR which are used to record video from another source (IN) or to send video to another source (OUT).

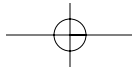

Specifications 53

Video Heads

Four heads (VRZ344)
Four heads with Hi-Fi stereo (VRZ364)

Video Signal

EIA standards; NTSC color

Antenna

VHF/UHF – 75 ohm external antenna terminal

VHF Output Signal

Channel 3 or 4 (switchable)
75 ohms unbalanced

Power Requirement

120V AC; 60 Hz

Power Consumption

20W (VRZ344)
22W (VRZ364)

Operating Temperature

41°F (5°C) to 104°F (40°C)

Relative Humidity

10% to 80%

Weight

7.3 lbs. (3.3 kg.)

Dimensions

14-15/16" (W) x 3-3/4" (H) x 10-1/2" (D)
(400mm x 94mm x 265mm)

Tuner Broadcast Channels

VHF: 2-13
UHF: 14-69

Cable TV Channels

VHF: 2 - 13
Midband: A - 1
Superband: J - W
Hyperband: A-5 - A-1
Special Channel: 5A
Ultraband: 37 - 94, 100 - 125

NOTE: Designs and specifications are subject to change without notice.

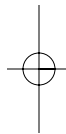
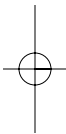

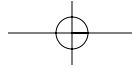

54 Helpful Hints

.....
 If you are having problems with your VCR, check the following list of problems and possible solutions before requesting service. You may be able to solve the problem yourself.

If you need to call a customer service representative, please know the model number and serial number of your product before you call. This information is displayed on the back of the product. Also, please take a moment to identify the problem you are having, and be prepared to explain this to the representative. If you believe the representative will need to help you with operations, please stay near the product. Our representatives will be happy to assist you.

The VCR has no power.

- Make sure the power plug is completely connected to an AC (alternating current) outlet.
- Make sure the power is turned on.

A power failure occurred.

- Select a language and set up channels, if prompted to do so. *Details are on pages 11 - 12 and 19.* Reset the clock. *Details are on pages 13 - 17.* You may also need to reprogram your timer recordings. *Details are on pages 35 - 40.*

The VCR cannot be controlled with the remote control.

- Aim the remote control directly at the VCR's remote sensor. *Details are on pages 5 and 22.*
- Remove all obstacles between the remote control and the VCR.
- Inspect and/or replace the batteries in the remote control. *Details are on page 5.*
- Press the VCR button, then try the other buttons.

The VCR does not respond normally to the remote control. (For example, the VCR may change channels multiple times when you press the CH(annel) ▲ button once.)

- Install new batteries (preferably alkaline) in the remote control.

The VCR will not perform a timer recording.

- Make sure the recording start and stop times are set correctly. *Details are on pages 35 - 40.*
- Make sure there is a tape in the VCR.
- Make sure the tape has a record tab. *Details are on page 5.*
- Make sure the VCR power is off.
- Make sure the clock is set. *Details are on pages 13 - 17.*
- The VCR may not perform or continue a timer recording if a power interruption of more than 10 minutes occurs, even if the power comes back on. If timer recordings are lost, - - : - - should appear on the display panel. But, even if you do not see this indication and the VCR operates normally, check programmed timer recordings. *Details are on page 40.*
- When you turn on the VCR after a power failure, this on-screen message may appear: POWER FAILURE OCCURRED/TIMER MEMORY CLEARED (IF PROGRAMMED)/PLEASE SET PROGRAMS TO BE RECORDED/TO END PUSH EXIT. First, reset the clock. *Details are on pages 13 - 17.* Then, set up channels. *Details are on pages 11 - 12.* Finally, program the timer recordings again. *Details are on pages 35 - 40.*
- Finish programming a timer recording at least five minutes before the recording is scheduled to begin.
- If two timer recordings overlap, CLASH will appear on-screen. The earlier program has priority; the later program will not be recorded.
- If the VCR power is turned off for a timer recording and there isn't a tape in the VCR, the ⊕ and Cassette Inside lights will blink on the display panel.
- If the record tab on a tape is missing and you turn off the VCR to set a timer recording, the VCR will eject the tape. The ⊕ and Cassette Inside lights will blink on the display panel.
- Noon is 12 p.m.; midnight is 12 a.m.
- Enter the Cable Box/DBS output channel (03 or 04) at step 3 on page 37, then select the channel to be recorded at the Cable Box/DBS. Leave the Cable Box/DBS on for the timer recording.

Tape can't be inserted.

- Insert the tape window side up, with the record tab facing you.
- Make sure a tape isn't already in the VCR by pressing the STOP/EJECT button on the VCR or the EJECT button on the remote control.
- Gently push the center of the tape as you put it in the VCR. Never force a tape into the VCR.

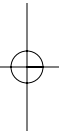
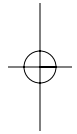

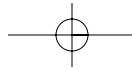

Helpful Hints (cont'd) 55

Tape can't be removed.

- Make sure the power plug is completely connected to an AC (alternating current) outlet.

The motor (cylinder) rotates even when the VCR is in Stop mode.

- To enable the quick play mechanism, the cylinder will rotate for about five minutes. This is normal. The quick play mechanism enables the tape mechanism to switch from Stop mode to Play mode in one second.

There is no playback picture, or the playback picture is noisy or contains streaks.

- Make sure the TV is on the same channel as the VCR's CH3/CH4 switch. *Details are on pages 6 - 9.*
- Make sure the VCR is in VCR position. *Details are on pages 20, 22, and 23.*
- Make sure channel 3 or 4 is properly adjusted at the TV.
- Adjust the tracking. *Details are on page 51.*

The Number buttons won't work for channels above 69; channels above 13 cannot be received.

- Select CABLE at the TUNER SET UP menu, then let the VCR set up the channels. *Details are on pages 11 - 12.*

A TV program cannot be recorded.

- Check the connections between the VCR, TV, antenna/cable, and Cable Box/DBS (if applicable). *Details are on pages 6 - 9.*
- Make sure channels are programmed correctly. *Details are on pages 11 - 12.*
- Make sure the tape has a record tab. *Details are on page 5.*

TV programs cannot be watched normally.

- Put the VCR in TV position. *Details are on pages 20, 22, and 24.*
- Check the connections between the VCR, TV, antenna/cable, and Cable Box/DBS (if applicable). *Details are on pages 6 - 9.*

Line Input mode is selected.

- If you accidentally enter Line Input mode (L-1 or L-F will appear on the display panel), use the CH(annel) ▲/▼ buttons or the Number buttons to select another channel.

Multi-Channel Television Sound System (VRZ364 only)

- You can only receive and record in stereo or second audio programs that are broadcast in stereo or second audio. You can only play in stereo or second audio tapes that were recorded in stereo or second audio. *Details are on pages 44 - 46.*
- If you select second audio when second audio is not available, the VCR will record normal audio.
- When you program your VCR to record in stereo, broadcasts are recorded in Hi-Fi stereo.
- You will only get stereo sound if you use audio cables to connect the AUDIO OUT Jacks on the VCR to the AUDIO IN Jacks on your TV. The TV must be in Line Input mode. See your TV owner's manual for details.
- When you connect the AUDIO OUT Jacks on your VCR to the AUDIO IN Jacks on your TV, the stereo light on the TV might not glow. This is normal. If the VCR indicates you are receiving a stereo broadcast, you are. (STEREO will appear in the status display.)

The VCR ejects the tape when the REC(ord)/OTR button is pressed or when the VCR power is turned off to set a timer recording.

- Make sure the tape has a record tab. *Details are on page 5.*

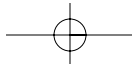

56 Limited Warranty

VIDEO CASSETTE RECORDER

90 Days Free Labor/One Year Parts Exchange. This product must be carried in for repair.

WHO IS COVERED?

You must have proof of purchase to receive warranty service. A sales receipt or other document showing that you purchased the product is considered proof of purchase.

WHAT IS COVERED?

Warranty coverage begins the day you buy your product. For 90 days thereafter, all parts will be repaired or replaced, and labor is free. From 90 days to one year from the day of purchase, all parts will be repaired or replaced, but you pay for all labor charges. After one year from the day of purchase, you pay for the replacement or repair of all parts, and for all labor charges.

All parts, including repaired and replaced parts, are covered only for the original warranty period. When the warranty on the product expires, the warranty on all replaced and repaired parts also expires.

WHAT IS EXCLUDED?

Your warranty does not cover:

- labor charges for installation or setup of the product, adjustment of customer controls on the product, and installation or repair of antenna systems outside of the product.
- product repair and/or part replacement because of misuse, accident, unauthorized repair or other cause not within the control of Philips Consumer Electronics Company.
- reception problems caused by signal conditions or cable or antenna systems outside the unit.
- a product that requires modification or adaptation to enable it to operate in any country other than the country for which it was designed, manufactured, approved and/or authorized, or repair of products damaged by these modifications.
- incidental or consequential damages resulting from the product. (Some states do not allow the exclusion of incidental or consequential damages, so the above exclusion may not apply to you. This includes, but is not limited to, prerecorded material, whether copyrighted or not copyrighted.)
- damage caused by the use of non-VHS tapes or tapes that have not been tested and labeled for use in two, four, six, and eight hour VHS recorders.
- a product that is used for commercial or institutional purposes (including but not limited to rental purposes).

WHERE IS SERVICE AVAILABLE?

Warranty service is available in all countries where the product is officially distributed by Philips Consumer Electronics Company. In countries where Philips Consumer Electronics Company does not distribute the product, the local Philips service organiza-

tion will attempt to provide service (although there may be a delay if the appropriate spare parts and technical manual(s) are not readily available).

MAKE SURE YOU KEEP...

Please keep your sales receipt or other document showing proof of purchase. Attach it to this owner's manual and keep both nearby. Also keep the original box and packing material in case you need to return your product.

BEFORE REQUESTING SERVICE...

Please check your owner's manual before requesting service. Adjustments of the controls discussed there may save you a service call.

TO GET WARRANTY SERVICE IN U.S.A., PUERTO RICO OR U.S. VIRGIN ISLANDS...

Take the product to a Philips factory service center (see enclosed list) or authorized service center for repair. When the product has been repaired, you must pick up the unit at the center. Centers may keep defective parts.

(In U.S.A., Puerto Rico and U.S. Virgin Islands, all implied warranties, including implied warranties of merchantability and fitness for a particular purpose, are limited in duration to the duration of this express warranty. Because some states do not allow limitations on how long an implied warranty may last, this limitation may not apply to you.)

TO GET WARRANTY SERVICE IN CANADA...

Please contact Philips at:

- 1-800-661-6162 (French Speaking)
- 1-800-363-7278 (English Speaking)

(In Canada, this warranty is given in lieu of all other warranties. No other warranties are expressed or implied, including any implied warranties of merchantability or fitness for a particular purpose. Philips is not liable under any circumstances for any direct, indirect, special, incidental, or consequential damages, howsoever incurred, even if notified of the possibility of such damages.)

REMEMBER...

Please record below the model and serial numbers found on the product. Also, please fill out and mail your warranty registration card promptly. It will be easier for us to notify you if necessary.

MODEL # _____
 SERIAL # _____

This warranty gives you specific legal rights. You may have other rights which vary from state to state.

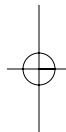
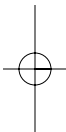

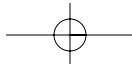

Index 57

ac power cord	25	hookups	38, 52
accessories	60	with a cable box/dbs	8 - 9
ant(enna) in jack	6 - 9, 25	without a cable box/dbs	6 - 7
audio in/out jacks	23, 25, 42, 45, 52	incredible picture	48
audio/mute button	21	index buttons	21, 43
automatic		index search feature	43
playback	51	language selection	19
rewind	51	limited warranty	56
batteries	5	line input mode	22, 42
cable box		line input mode light	22
code	28	long play	38, 52
connections	8 - 9	lp	38, 52
output channel	8 - 9, 52	maintenance	5
cable/tv channels	33 - 34	menu button	21
cassette compartment	22	mts broadcast	44 - 45
cassette inside light	22	number buttons	20
cbl/dbs button	20	on screen mode	26
ch3/ch4 switch	25	one-touch recording	31
channel		operation indicators	22
adding	12	output channel	8 - 9, 52
deleting	12	pbs channel selection	
display	22	automatic	17
setup	11	manual	16
▲/▼ buttons	23, 51	picture enhancer	48
clear button	20	play button	20, 24, 29
clock		playback	29
display	22	options	49
setting	13 - 17	pluscode programming number	35
automatically	16 - 17	power button	20, 23
manually	13 - 14	program review	40
time zone selection	15	quick programming	37 - 40
connections	6 - 9, 42, 45	real-time counter	22
contents, table of	4	rear panel	25
controls		rec(ord)/otr button	20, 23, 30 - 31
remote	20 - 21	record tab	5
vcr	22 - 25	recording	
daily button	36	basic	30
date button	39	one channel/watching	32
daylight-saving time	18	remote control	
dbs		buttons	20 - 21
code	28	sensor	22
connections	8 - 9	using	5
display panel	22	repeat playback	49
duplication	42	rerecording	42
eject button	20	reverse searching	49
erase protection	5	rew(ind) ◀ button	20, 24, 49
exit/status button	21	rf coaxial cable	6 - 9
fast forward searching	49	rf out jack	6 - 9, 25
ff (fast forward) ▶/OK		safety precautions	3
button	20	second audio broadcast	44 - 45
frame advance	49	skip button	21
front panel	23 - 24	slow motion	49
glossary	52	slp	38, 52
helpful hints	54 - 55	sp	38, 52
hi-fi stereo playback	46	specifications	53
		speed button	21
		sqpb	29
		standard play	38, 52
		start +/- button	38
		stereo broadcast	44
		still/pause button	23
		still/slow button	21
		still/slow +/- buttons	21
		still picture	49
		stop ▼ button	20
		stop +/- button	38
		stop/eject button	24
		super long play	38, 52
		table of contents	4
		tape	
		duplication	42
		eject	20, 51
		speed	38, 52
		speed lights	22
		time remaining	26
		time zone selection	15
		timer	
		button	21
		light	22
		recording	35 - 40
		checking	40
		clearing	40
		helpful hints	54
		programming	35 - 40
		reviewing	40
		speed setting	41
		with vcr plus+ program-	
		ming system	33 - 36
		tracking adjustment	51
		tv	
		button	20
		controls	27
		hookups	6 - 9
		position	20, 24
		remote control code	27
		variable slow motion	49
		vcr	
		light	22
		position	20, 24
		vcr plus+ channels	33 - 34
		vcr plus+ programming system	
		setting up	33 - 34
		timer recording	35 - 36
		vcr/tv button	20, 24
		video	
		in/out jacks	23, 25, 52
		stabilizer	47
		tapes	5, 38
		vol(ume) ▲/▼ buttons	21
		warranty	56
		weekly button	36

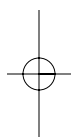

SUPPLIED ACCESSORIES

Check to be sure the items on this page are packed with your VCR. These accessories are provided to help you use or set up your VCR.

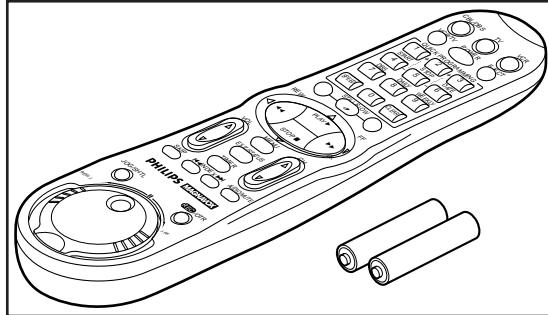

**Remote Control 4835 218 37221
Two "AA" Batteries 4835 138 17012**

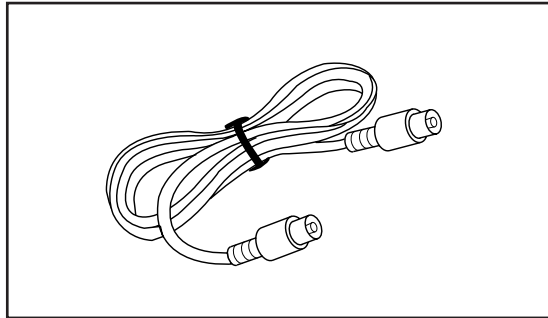

RF Coaxial Cable 4835 321 27302

If any of these items are not included, or if you need to replace an item, contact Philips Service Solutions Group at the address below.

***Philips Service Solutions Group
P.O. Box 967
Greeneville, TN 37744-0967***

Or, call 1-800-851-8885.