

NT 773 I / 993 I

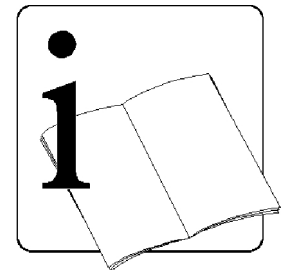



Inhaltsverzeichnis	Seite
Inbetriebnahme	5
Betriebsanleitung	6
Kärcher-Niederlassungen	85
Technische Daten / Schaltplan / Ersatzteilliste	86/87/88
Zubehör / Filtersysteme	89/90

Vor erster Inbetriebnahme Betriebsanleitung und Sicherheitshinweise Nr. 5.956-249 unbedingt lesen! Dieses Gerät ist für den gewerblichen Gebrauch geeignet, z.B. in Hotels, Schulen, Krankenhäusern, Fabriken, Läden, Büros und Vermietergeschäften.

Lists of contents	Page
Commissioning	5
Operating Instructions	10
Kärcher branches	85
Technical Data / Wiring diagram / Spare Parts List	86/87/88
Accessories / Filter systems	89/90

Prior to initial startup, operating manual and safety instructions no.. 5.956-249 must be consulted! This machine is suitable for industrial use, for instance in hotels, schools, hospitals, factories, shops, offices and on hire.

Tables des matières	Page
Mise en service	5
Notice d'instructions	14
Filiales Kärcher	85
Caractéristiques techniques / Schéma de câblage / Liste des pièces de rechange	86/87/88
Accessoires / Systèmes de filtres	89/90

Avant la première mise en service, lire absolument le mode d'emploi et les 5.956-249 remarques de sécurité! Cet appareil est adapté à l'usage professionnel, p. ex. dans les hôtels, les écoles, les hôpitaux, les usines, les magasins, les bureaux et les locations.

Indici	Pagina
Messa in funzione	5
Istruzioni per l'uso	18
Filiali Kärcher	85
Dati tecnici / Schema elettrico / Elenco pezzi di ricambio	86/87/88
Accessori	89/90

Prima della prima messa in funzione leggere assolutamente . le istruzioni per l'uso e le avvertenze per la sicurezza n. 5.956-249! Questo apparecchio è adatto per settori commerciali, per es. hotel, scuole, ospedali, fabbriche, negozi, uffici e noleggi

Inhoudsopgave	Pagina
Inbedrijfstelling	5
Gebruiksaanwijzing	22
Kärcher – filialen	85
Technische gegevens / Schakelschema / Reserveonderdelenlijst	86/87/88
Accessoires / Filtersystemen	89/90

Vóór de eerste ingebruikneming de gebruiksaanwijzing en de veiligheidsinstructies nr.: 5.956-249 beslist lezen!
Dit apparaat is geschikt voor professioneel gebruik, bijv. in hotels, scholen, ziekenhuizen, winkels, kantoren en verhuurbedrijven.

Índices	Paginación
Puesta en servicio	5
Instrucciones de servicio	26
Filiales de Kärcher	85
Datos técnicos / Diagrama de conexiones / Lista de piezas de requesto	86/87/88
Accesorios / Sistemas de filtros	89/90

Las instrucciones de servicio y las indicaciones de seguridad núm.. 5.956-249 se deben leer imprescindiblemente antes de la primera puesta en servicio!
Este aparato es apropiado para el uso a escala industrial, p. ej. en hoteles, centros escolares, hospitales, fábricas, tiendas comerciales, oficinas y empresas dedicadas al alquiler.

Índices	Página
Colocação em funcionamento	5
Manual de instruções	30
Filiais da Kärcher	85
Dados técnicos / Esquema de ligações / Lista de peças sobresselentes	86/87/88
Accessórios / Sistemas de Filtro	89/90

Antes da primeira colocação em funcionamento, ler atentamente. o manual de instruções e as indicações de segurança nº5.956-249!
Este aparelho destina-se ao uso industrial, nomeadamente em hotéis, escolas, hospitais, fábricas, lojas, escritórios e empresas de alugar.

Πίνακες περιεχομένων	σελίδα
Θέση σε λειτουργία	5
Οδηγίες λειτουργίας	34
Αντιπροσωπείες Kärcher	85
Τεχνικά χαρακτηριστικά/Κυκλωματικό διάγραμμα / ανταλλακτικά εξαρτήματα / Συστήματα φίλτρων	86/87/88
89/90	

Πριν από την πρώτη θέση λειτουργίας διαβάστε οπωσδήποτε τις Οδηγίες χρήσης και Υποδείξεις ασφάλειας . αρ. 5.956-249!
Αυτή η συσκευή είναι κατάλληλη για την επαγγελματική χρήση, π.κ. σε ξενοδοχεία, σχολεία, νοσοκομεία, εργοστάσια, καταστήματα, γραφεία και εταιρείες δανεισμού συσκευών.



Indholdfortegnelser	Side
Idrifttagning	5
Driftsvejledning	38
Kärcher agenturer	85
Tekniske data / Strømskema / Reservedeliste	86/87/88
Tilbehør / Filtersystemer	89/90

Inden første idrifttagning skal driftsvejledningen og sikkerhedshenvisningerne nr. 5.956-249 læses!

Dette apparat er beregnet til erhvervs-mæssig brug, f.eks. i hoteller, skoler, sygehuse, fabrikker, forretninger, kontorer og udlejningsforretninger.

Innholdsfortegnelser	Side
Igangsetting	5
Bruksanvisning	42
Kärcher filialer	85
Tekniske data / Kopplingskjema / Reservedeliste	86/87/88
Tilbehør / Filtersystemer	89/90

Før første gangs bruk må bruksanvisning og sikkerhetsanvisning nr. 5.956-249 ubetinget leses!

Denne maskinen er egnet til bruk i næringslivet, f.eks. i hoteller, skoler, sykehus, fabrikker, butikker, kontorer og utleiebutikker.

Innehållsförteckningar	Sid
Idrifttagning	5
Driftinstruktion	46
Kärcher filialer	85
Tekniska data / Kopplingsschema / Reservdelista	86/87/88
Tillbehör / Filtersystem	89/90

Läs noga instruktionsboken och säkerhetsanvisningarna nr. 5.956-249 innan aggregatet tas i bruk!

Denna apparat är lämplig för användning inom näringslivet, t.ex. hotell, skolor, sjukhus, fabriker, butiker, kontor och uthyringsaffärer.

Sisällysluettelo	Sivu
Käyttöönnotto	5
Käyttöohje	50
Kärcher-toimipisteet	85
Tekniset tiedot / Kytentäkaavio / Varaosalista	86/87/88
Lisävarusteet / Suodatinjärjestelmät	89/90

Ennen ensimmäistä käyttöönottoa on käyttöohje ja turvallisuusohjeet numero. 5.956-249 ehdottomasti luettava!

Tämä laite soveltuu ammattimaiseen käyttöön esim. hotelleissa, kouluissa, sairaaloissa, tehtaissa, myymälätiloissa, toimistoissa ja vuokrausliikkeissä.

Tartalomjegyzék	Oldal
Üzembevétele	5
Üzemeltetési utasítás	54
Kärcher telephelyek	85
Műszaki adatok / Kapcsolási rajz / Cserealkatrészlista	86/87/88
Kellékek / Szűrőrendszerek	89/90

Az első üzembevétele előtt Üzemeltetési utasítást és a számú biztonsági utalást. 5.956-249 feltétlenül elolvasni!

E készülék ipari célra készült, például szállodákban, iskolákban, kórházakban, gyárakban, raktárakban, irodákban és üzletekben használható

Obsah	Strana
Uvedení do provozu	5
Návod k obsluze	58
Zastoupení Kärcher	85
Technické údaje / Schéma zapojení / Seznam náhradních dílů	86/87/88
Príslušenství / Filtrační systémy	89/90

Před prvním uvedením do provozu si bezpodmínečně přečtěte návod k obsluze. a bezpečnostní upozornění č. 5.956-249!

Tento přístroj je vhodný pro komerční použití, např. v hotelech, školách, nemocnicích, továrnách, obchodech, kancelářích a půjčovnách.

Kazalo	Stran
Zagon	5
Navodila za obratovanje	62
Kärcher-poslovalnice	85
Tehnični podatki / vezalni načrt / seznam nadomestnih delov	86/87/88
Oprema / Filtrirni sistemi	89/90

Pred prvim zagonom je potrebno prebrati navodila za obratovanje in varnostne napotke št. 5.956-249!

Ta naprava je primerna za gospodarsko rabo, npr. v hotelih, šolah, bolnišnicah, tovarnah, trgovinah, pisarnah in najemnih prostorih.



Spis treści	Strona
Uruchomienie	5
Instrukcja obsługi	66
Filie firmy Kärcher	85
Dane techniczne / Schemat ideowy / Lista części zamiennych	86/87/88
Wyposażenie dodatkowe / systemy filtracyjne	89/90

Przed pierwszym uruchomieniem należy koniecznie przeczytać. 5.956-249 instrukcję obsługi i wskazówki dotyczące bezpieczeństwa nr I do zasysania substancji płynnych.

Urządzenie to przeznaczone jest do użytku przemysłowego, np. w hotelach, szkołach, szpitalach, fabrykach, sklepach, biurach i wypożyczalniach.

Cuprins	Pagina
Luare în exploatare	5
Instrucțiuni de folosire	70
Sucursale Kärcher	85
Date tehnice / Planul de conexiuni / Listă de piese de schimb	86/87/88
Accesorii / Sisteme de filtrare	89/90

Înainte de prima luare în exploatare, instrucțiunile de folosire și indicațiile de siguranță nr. 5.956-249 trebuie citite neapărat!

Acest aparat este adecvat folosirii profesionale, de ex. în hoteluri, școli, spitale, fabrici, magazine, birouri și spații comerciale închiriate.

İçindekiler	Sayfa
Servise koyma	5
Kullanma Kılavuzu	74
Kärcher şubeleri	85
Teknik özellikler / Tevzi planı/Yedek parça listesi	86/87/88
Aksesuar / Filtre Sistemleri	89/90

Cihazı ilk kez çalıştırmadan önce kullanım kılavuzu güvenli bilgilerini No. 5.956-249 mutlaka okuyun!

Bu cihaz ticari kullanım için uygundur; örn. otellerde, okullarda, hastanelerde, fabrikalarda, dükkanlarda, satış merkezlerinde, bürolarda ve kiralamaya işletmelerinde kullanılabilir.

Cihazın kullanım ömrü 10 yıldır.

Содержание	Страница
Ввод в эксплуатацию	5
Руководство по эксплуатации	78
Филиалы фирмы Kärcher	85
Технические характеристики/ Электрическая схема/ запасные части	86/87/88
Принадлежности / Фильтровальные системы	89/90

Перед первым пуском руководство по эксплуатации и указания по безопасности №. 5.956-249 следует обязательно прочитать!

Этот прибор предназначен для промышленного применения, например, в гостиницах, школах, больницах, фабриках, магазинах, бюро, арендных помещениях.

Zoznam	Strana
Uvedenie do prevádzky	5
Návod k prevádzke	82
Zastúpenie Kärcher	85
Technické údaje / Schéma zapojenia / Zoznam náhradných dielov	86/87/88
Príslušenstvo / Filtračné systémy	89/90

Pred prvým zapojením do prevádzky je bezpodmienečne nutné prečítať si Návod k prevádzke a Bezpečnostné pokyny č. 5.956-249. Tento prístroj je určený na použitie v nebytových priestoroch, napr. v hoteloch, školách, nemocniciach, továrňach, obchodoch, kanceláriách a je možné ho za týmto účelom prenajímať.

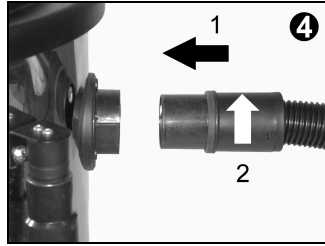
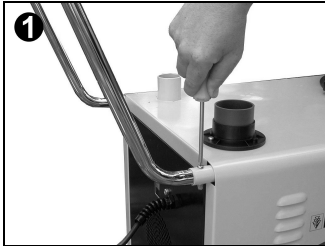

Contents

Commissioning	10
Mains connection	10
Dry suction	10
Fitting the paper filter bag (only NT 773 I, optional)	10
Empty the container	11
Wet-vacuuuming	11
Empty the container	11
Care and maintenance	12
Fault instructions	12
EC conformity declaration	12

Commissioning

Mains connection

See technical data and rating plate for connected load

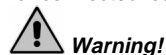

Warning!

Check suction turbine's direction of rotation whenever changing to a different plug socket. The suction connection piece of the unit must be under partial vacuum. If direction of rotation is wrong: interchange terminals at unit plug. When an extension cable is used it should always be completely unwound and have an adequate cross-section.

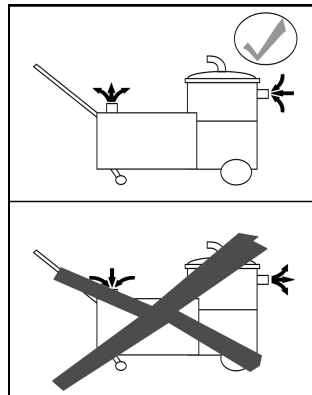
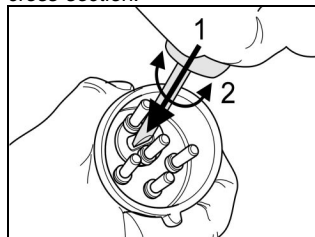

Dry suction



Warning!

Never remove the cartridge filter during vacuuming. A paper filter bag or a membrane filter can also be used when sucking up fine dust.

Fitting the paper filter bag (only NT 773 I, optional)

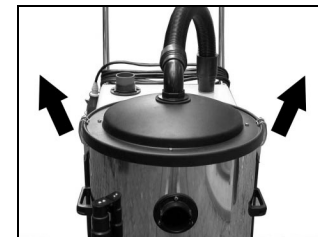

- Remove the suction hose at the suction head
- Unlock and remove the suction head

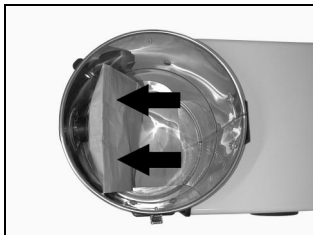

- Insert the paper filter bag
- Replace the suction head and lock it in place
- Fit the suction hose back on the suction head

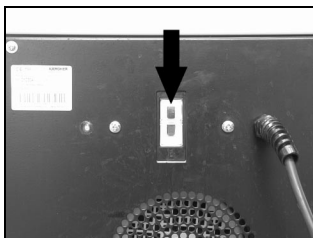

- Insert power plug
- Switch on the machine and start using it.
- Note the suction turbine's direction of rotation

Empty the container



- Switch off the unit
 - Remove the suction hose at the suction head
 - Unlock and remove the suction head
 - Lift the container vertically at the two grips (1)
- The container is nested at item (2)

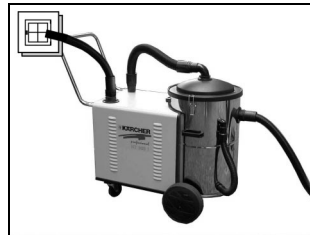

Note:

The exhaust can be discharged with an additional hose (Ø at least 50 mm)

Wet-vacuuming



Warning!

Always remove the paper filter bag or the membrane filter prior to vacuuming wet dirt.

- Remove paper filter bag or membrane filter
- Insert power plug
- Switch on the machine and start using it
- Note the suction turbine's direction of rotation

Empty the container



- Switch off the unit
- Drain dirty water using the drain hose

Note:

Clean and dry container after finishing wet vacuuming.

Care and maintenance



Danger!

Always pull out the mains plug when working on the suction machine



Cleaning the protective gratings in the hose to the suction head and at the appliance

Fault instructions

The suction turbine does not run

- Check the cable, plug, fuse and socket.
- Switch on the machine.

The suction power decreases

- Empty the container.
- Remove obstructions out of the suction nozzle, the suction tube, the suction hose or the suction hose to the suction head.
- Clean/replace cartridge filter.
- Replace paper filter bag or membrane filter.

Dust ejects when sucking

- Check fit of cartridge filter.
- Lock the suction head.

No suction power

- Empty the container.
- Switch the appliance off and on again after 10 seconds.
- Clean float system in cartridge filter.

EC conformity declaration

We hereby declare that due to its concept and workmanship as well as the marketed design, the machine specified below complies with the relevant fundamental safety and health requirements of the EC directives listed below.

Modification of the machine without our approval invalidates this declaration.

Product: Wet/Dry Vacuum Cleaner
Type: 1.294-xxx 1.297-xxx

Relevant EC directives

EC machine directive (98/37/EC)
EC low voltage directive (73/23/EEC) amended by 93/68/EEC
EC directive on electromagnetic compatibility (89/336/EEC) amended by 91/263/EEC, 92/31/EEC, 93/68/EEC

Applied harmonised standards

DIN EN 60335-1
DIN EN 60335-2-69
DIN EN 61000-3-2:1995
DIN EN 61000-3-3:1995
DIN EN 55014-1:1999
DIN EN 55014-2:1997
Internal company measures ensure that standard units always comply with the requirements of current EC directives and applied standards. The signatories act for and in authority of management.

5.957-624 (06/01)
Alfred Kärcher Limited
Partnership.
Registered office: Winnenden.
Company Register: Waiblingen, HRA 169.
Personally liable partner. Kärcher Reinigungstechnik GmbH.
Registered office Winnenden, 2404 Waiblingen Company Register, HRB

Managing directors:
Dr. Bernhard Graf,
Hartmut Jenner,
Herbert Konhäusner, Georg Metz,
Thomas Schöbinger

Alfred Kärcher GmbH & Co.
Cleaning Systems
Alfred-Kärcher-Straße 28-40
P.O.Box 160
D-71349 Winnenden, Germany
Phone: ++49 7195 14-0
Fax :++49 7195 14-2212



(Graf Reiser Schöbinger)

NT 773 I / NT 993 I

A
 Alfred Kärcher Ges. m.b.H.
 Lichtblaustraße 7
 A-1220 Wien

AUS
 Kärcher (Pty.) Ltd.
 2/158 Browns Road
 Noble Park 3174
 Melbourne, Vict.

B, L, NL
 Kärcher Benelux
 Industrieweg 12
 2320 Hoogstraden

BR
 Kärcher Industria e Comércio Ltda.
 Av. Prof. Benedito Montenegro
 nº419
 Paulinia – Estado de Sao Paulo
 CEP 13.140-000

CDN
 Kärcher Cleaning Systems Inc.
 1770 Alstep Drive
 Mississauga, Ontario L5S1W1

CH
 Kärcher Variorapid AG
 Industriestr. 16
 CH - 8101 Dällikon

CZ
 Kärcher spol. S. r. a.
 Za Mototschnou
 155 00 Praha – Stodůlky

D
**Alfred Kärcher GmbH & Co
 Vertrieb Deutschland
 Friedrich - List - Straße 4
 D - 71364 Winnenden**

DK
 Kärcher A/S
 Gejihavegaard 5
 DK – 6000 Kolding

E
 Kärcher S.A.
 Pol. Industrial Font del Radium
 Calle Doctor Trueta 6-7
 E - 08400 Granollers (Barcelona)

F
 Kärcher S.A.
 Z.A. des Petits Carreaux
 5, avenue des Coquelicots
 F - 94865 Bonneuil s.
 Marne/CEDEX

FIN
 Kärcher Oy
 Yrittäjätie 17
 FIN - 01800 Klaukkala

GB
 Kärcher (U.K.) Ltd.
 Kärcher House
 Beaumont Road
 Banbury Oxon, OX 16 7TB

GR
 Kärcher S.A.
 Cleaning Systems
 99 Aristoutelous & Ioanninon
 GR - 136 71 Aharnes

H
 Kärcher Hungaria KFT
 Budapest XXI
 Gyepsor u. 1
 P.O. Box 83
 1751 Budapest

HK
 Kärcher Ltd.
 Unit 10, 17/FL. APEC Plaza
 49 Hoi Yuen Road
 Kwun Tong, Kowloon

I
 Kärcher S.p.A.
 Via Elvetia 4
 I - 25050 Cantello (VA)

J
 Kärcher (Japan) Co., Ltd.
 Irene Kärcher Building
 No. 2, Matsusaka-Daira 3-chome
 Taiwa-cho, Kurokawa-gun
 Miyagi, 981-34, Japan

N
 Kärcher A/S
 Gjerdrumsvei 4
 Postboks 94, Grefsen
 N - 0409 Oslo

P
 Neoparts
 Comercio e Indústria Automovel,
 Lda
 Largo Vitorino Damásio. 10
 1200 Lisbon

PL
 Kärcher Poland Ltd.
 Sp. zo. o.
 Ul. Godlewskiego 22
 30-198 Kraków

S
 Kärcher AB
 Box 24
 S - 42502 Hisings - Kärra

USA
 Alfred Kärcher Inc.
 P.O. Box 6510
 1600 Cottontail Lane
 Somerset, NJ 08875

ZA
 Kärcher (Pty.) Ltd.
 P.O. Box 2417
 Kempton Park 1620

NT 773 I / NT 993 I

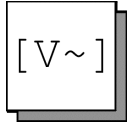

EUR: 400 V / 3~50 Hz



10 m
H07RN-F4G x 1,5
EUR: 6.641-148
(Meterware)
(To order as cut goods)
(Commande comme marchandise
au metre)



NT 773 I 72 dB (A)
NT 993 I 76 dB (A)

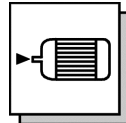

NT 773 I
P norm: 1850 W
P max: 2100 W
NT 993 I
P norm: 3500 W
P max: 4000 W

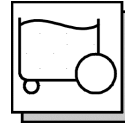

NT 773 I: 81 l
NT 993 I: 105 l

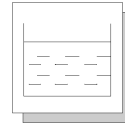

NT 773 I: 54 l
NT 993 I: 75 l

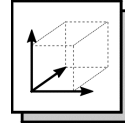

NT 773 I 1170mm x 590 mm x 1030 mm
NT 993 I 1170mm x 590 mm x 1070 mm

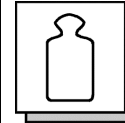

NT 773 I 70 kg
NT 993 I 80 kg



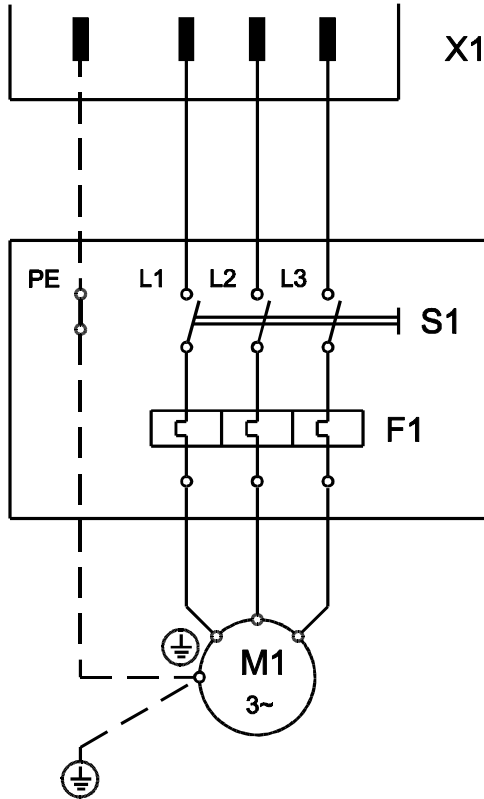





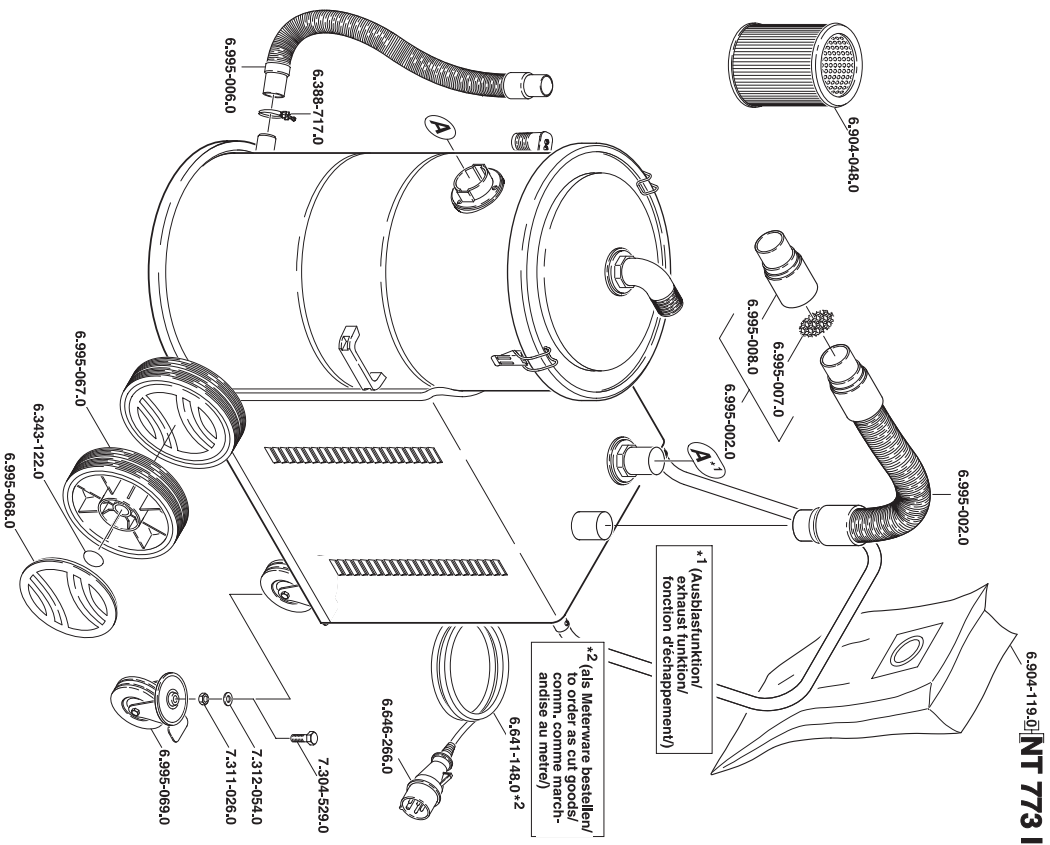

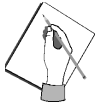
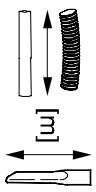
400V / 3~ 50HZ

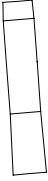
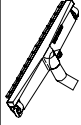

- M1 Saugturbine
Suction turbine
- S1 Turbine d'aspiration
Schalter Turbine
Switch suction turbine
Interrupteur de turbine
- X1 Stecker
Plug
Fiche
- F1 Sicherung
Fuse
Fusible

NT 773 I | **NT 993 I**
 1.294-101.0 | 1.297-101.0

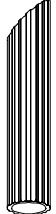

		<p>4.440-263 4.440-303 OL 4.440-612 OL 4.440-613 OL 4.440-614 OL 4.440-615 SP 4.440-616 EL 4.440-617 EL</p>	<p>40 40 40 40 50 50 50 50</p>	<p>4,0 4,0 10,0 4,0 10,0 10,0 4,0 10,0</p>		
		<p>6.900-276 M 6.902-011 M / M 6.902-080 RS</p>	<p>40 50 50</p>			
		<p>6.900-275 M 6.902-013 M 6.902-082 RS</p>	<p>40 50 50</p>	<p>0,5 0,5 0,5</p>		
		<p>6.903-051 ALU 6.903-018 ALU 6.903-038 ALU</p>	<p>40 40 50</p>			<p>450 370 500</p>
		<p>6.903-063 6.903-062 6.903-081 OL 6.906-066</p>				<p>450 370 370 500</p>
		<p>6.903-065 6.904-064 6.903-067</p>				<p>450 370 500</p>
		<p>6.903-033 6.900-222 6.900-926</p>	<p>40 50 50</p>	<p>290 370 200</p>		
		<p>6.900-226 6.900-927 ALU 6.903-233 (Δ) K</p>	<p>50 50 50</p>			<p>176 x 126 200 x 70 152 (Δ)</p>
		6.903-360 RS	50			115 x 35
		<p>6.902-105 G 6.902-106 G</p>	<p>40 50</p>	<p>220 220</p>		
		4.783-057 G	40	200		

EL = elektrisch leitend
electrical conductive
conducteur électrique

K = Kunststoff
plastic
plastique

SP = Mit Stahlspirale
with steel spiral
et acier spirale





OL = ölbeständig
oil resistant
résistant à l'huile

M = Metall
metal
métal

RS = rostfreier Stahl
stainless steel
acier inoxydable

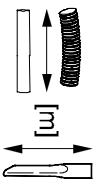
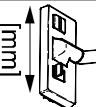
G = Gummi
rubber
caoutchouc

ALU = Aluminium
aluminium
aluminium

		<p>Ø [mm]</p>	 <p>[m]</p>	 <p>[mm]</p>
	<p>6.906-105</p>			
	<p>6.904-119 (NT 773 I)</p>			
	<p>6.904-048</p>			
	<p>2.639-780</p>			
<p>EL = elektrisch leitend electrical conductive conducteur électrique</p> <p>M = Metall métal</p>	<p>K = Kunststoff plastic</p> <p>RS = rostfreier Stahl stainless steel acier inoxydable</p>	<p>SP = Mit Stahlspirale with steel spiral et acier spirale</p>	<p>OL = ölbeständig oil resistant résistant à l'huile</p>	<p>ALU = Aluminium aluminium</p>