A large, stylized letter 'M' in a light gray color, centered on a black background. The 'M' is composed of thick, solid lines. The text 'user guide' is written in a white, lowercase, sans-serif font, following the diagonal slope of the right-hand side of the 'M'.

user guide

Meridian 596 DVD Player

Meridian 596 DVD Player User Guide

Sales and service in the UK

Meridian Audio Ltd
Stonehill
Stukeley Meadows
Cambs
PE29 6EX
England

Tel (01480) 52144
Fax (01480) 459934

World Wide Web
<http://www.meridian-audio.com>

Part no: 596

Sales and service in the USA

Meridian America Inc
3800 Camp Creek Parkway
Building 2400
Suite 122
Atlanta
GA 30331

Tel (404) 344 7111
Fax (404) 346 7111

Designed and manufactured in the UK by

Meridian Audio Ltd
Stonehill
Stukeley Meadows
Cambs
PE29 6EX
England

Copyright © 2000 Meridian Audio Ltd

Dolby, Dolby Digital, Pro Logic, AC-3, and the double-D symbol are trademarks of Dolby Laboratories Licensing Corporation. BoothroydStuart Meridian, Meridian, and Meridian Digital Theatre are registered trademarks of Meridian Audio Ltd.

This product incorporates copyright protection technology that is protected by method claims of certain U.S. patents and other intellectual property rights owned by Macrovision Corporation

and other rights owners. Use of this copyright protection technology must be authorized by Macrovision Corporation, and is intended for home and other limited viewing uses only unless otherwise authorized by Macrovision Corporation. Reverse engineering or disassembly is prohibited.

This guide was produced by Human-Computer Interface Ltd,
<http://www.interface.co.uk>

Contents

Introduction **1**

Introduces the 596 DVD player, and gives examples of two suggested configurations using it in conjunction with other Meridian products.

The Meridian 500 Series	2
Sample configurations	3
Specification and accessories	5

Using the DVD player **7**

Provide step-by-step instructions on operating the DVD player, using either the front panel or the Meridian System Remote.

Front panel	8
Meridian System Remote	9
Playing a disc	10
Locating a specific title, chapter, or track	12
Stopping, pausing, and resuming play	14
Disc information	15

Advanced features **17**

Describes the more advanced features of the DVD player.

Selecting options from a menu	18
Fast and slow-motion play	19
Playing repeatedly	20
Selecting a playback audio setting	21
Displaying subtitles	22
Selecting the camera angle	23
Setting the parental lock	24

Setting default options 27

Explains how to set up the default options using the DVD player's Setup menu.

Setting default options	28
Selecting the default languages	30
Selecting the display settings	32
Selecting the audio settings	38

Setting up the DVD player 41

Describes how to unpack and install the DVD player.

Unpacking	42
Positioning the DVD player	43
Back panel	44
Connecting video	47
Connecting audio	48
Connecting to other Meridian equipment	50

Configuring the DVD player 51

Explains how to configure the DVD player to suit the other equipment in your system.

Choosing standard settings	52
Configuring the 596 DVD Player	53

Troubleshooting 55

Provides suggested solutions to typical problems.

Troubleshooting	56
Maintenance	59
Service and guarantee	60
Index	61



Introduction

The 596 DVD video player combines Meridian's extensive experience of producing audiophile CD players with their close involvement in the development of DVD formats, resulting in an outstanding DVD player that takes full advantage of the capabilities of DVD.

The 596 uses a precision DVD-ROM drive, with the audio and video data read asynchronously and then triple buffered to isolate output timing from the mechanics of the drive. The audio is also dejittered using very precise master oscillators to give a clear, open, authoritative sound.

The 596 provides a range of component and composite video output options, and switches automatically between NTSC and PAL. It uses advanced video circuitry and a studio-grade video encoder to produce an extremely clear picture with low noise and remarkable clarity.

For instructions on setting up the unit turn to *Setting up the DVD player*, page 41. Once the DVD player has been set up refer to the next chapter, *Using the DVD player*, for information about playing discs.

The Meridian 500 Series

The Meridian 500 Series is a unique system of digital, analogue, and video components designed to meet the demand for absolute quality, ease of use, and lasting value.

The flexibility of the Meridian 500 Series is such that you can assemble a system as simple or as complex as you need, perfectly suited to your musical and environmental requirements, and which can be added to or changed at a later date should your requirements change.

Each Meridian 500 Series component is housed in a matching slim line case. Front panel controls provide access to the most important functions, and the full range of functions is available from the appropriate remote control using a simple and intuitive control interface.

500 Series communications

The Meridian 500 Series includes a sophisticated communications link, to ensure that any configuration of units will work together as a fully integrated system.

The 500 Series communications system allows you to control any combination of units using a single remote, and ensures that your commands from the remote are interpreted unambiguously. The communications system also allows you to extend your hi-fi system into two or three rooms, with the ability to control the sources in one room from the controller in another room.

Professional features

The 500 Series also includes features for professional users, including RS232 computer control and balanced connections.

The following pages give examples of two suggested configurations incorporating the 596 DVD Player, to illustrate the flexibility of the Meridian 500 Series.

Sample configurations

Meridian Digital Theatre™

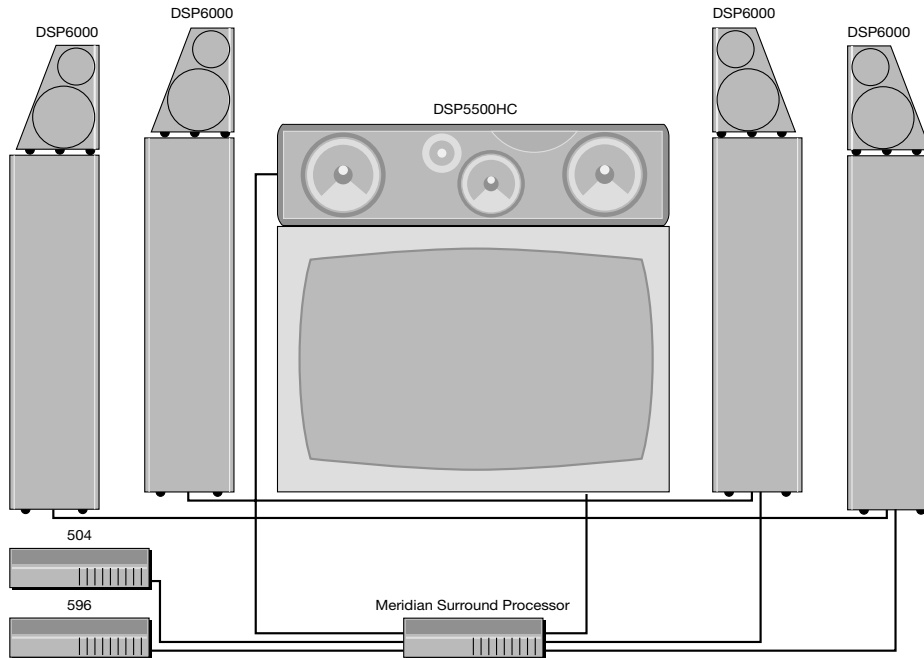

The Meridian 596 DVD Player is ideal for use with a Meridian Surround Processor as the heart of a Meridian Digital Theatre system.

The Meridian Surround Processor can decode Dolby Digital (AC-3), MPEG Surround, DTS Audio, and Dolby Surround soundtracks.

Meridian Digital Music System

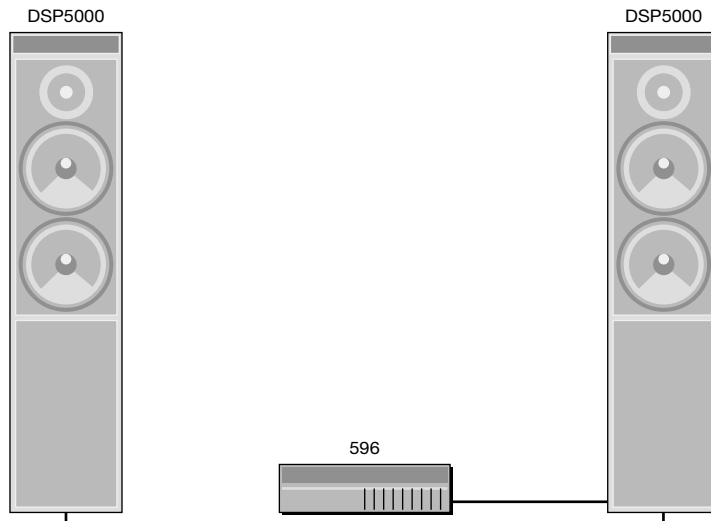

The 596 DVD Player can be connected directly to Meridian DSP loudspeakers, as these include DSP volume and tone controls.

By careful design Meridian have achieved a sound quality with audio CDs which approaches that of their dedicated CD players.

In addition to playing DVD discs, the 596 can play audio CDs, VCD, CVCD, and MP3 files on CD-ROM.

Specification and accessories

Specification

THD	Less than -93dBFS.
Noise	Less than -93dBFS.
Mechanism	Dual-lens pickup with red laser.
Formats	DVD-Video, CD Audio (CD-DA), CD-R, Video CD (VCD), CVCD, and MP3.
Processing	DSP software provides error correction and on-board decoding for Dolby Digital and MPEG Audio.
Conversion	24-bit Delta Sigma.
Display	12-character dot-matrix display. Indicators for CD, DVD, MP3, and Repeat. Switchable custom on-screen display allows instant review of disc status.
Finish	Black textured enamel and glass.
Dimensions	88mm x 321mm x 332mm (3.46" x 12.64" x 13.07").
Weight	6.4kg (14lbs).

Audio outputs

1 x digital coax SPDIF/IEC1937/MHR for transferring PCM up to 96kHz 24-bit Dolby Digital (AC-3) or DTS bitstreams.

1 x stereo analogue direct-coupled design featuring 192kHz 24-bit conversion. All audio outputs use FIFO and relocking to give extremely low jitter.

Video outputs

PAL or NTSC encoded as Composite or S-Video. Component or RGB. Black-level setup adjustable as 0 or 7.5IRE (Extended Black function). 16:9 and 4:3 displays supported. Screen saver programmable by user.

Communications

Two 5 pin 240° DIN sockets. Full RS232 control and status for custom integration or automation.

Power

Universal supply 100-240V, 50-60Hz, 25W. Normally off automatic low-noise fan cooling.

Available accessories

The following accessories are available from your dealer:

- Power cord Europe.
- Power cord Canada and USA.

If you have problems purchasing these items, you can order them direct from Meridian Audio Limited, who can also supply a range of cables suitable for connecting the 596 DVD Player to other equipment.

Using the DVD player

This chapter provides a summary of the functions of the DVD player in order to identify the controls which you use to operate the unit.

It also describes the basic aspects of using the DVD player to play DVD video discs and audio CDs.

Unless otherwise specified, each function is available from the front panel or the Meridian System Remote.

Front panel

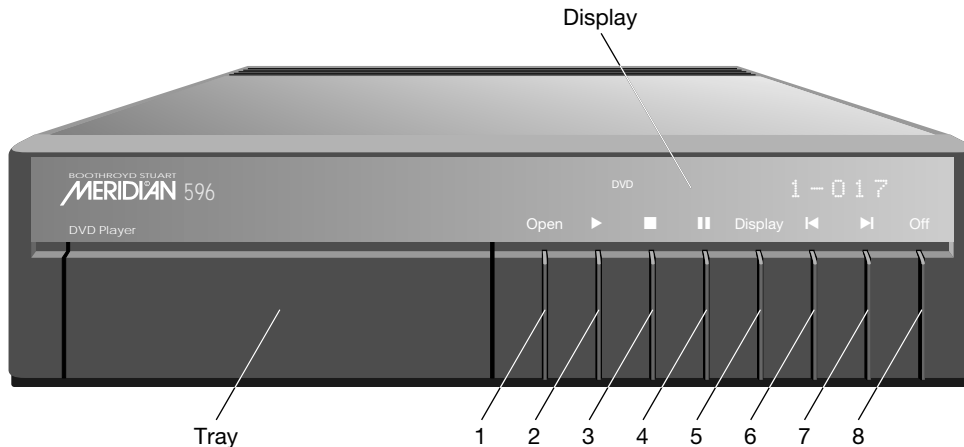

- 1 Open**
Opens and closes the disc tray.
- 2 ► (Play)**
Plays a selected chapter/track.
- 3 ■ (Stop)**
Stops the disc.
- 4 || (Pause)**
Pauses the disc.
- 5 Display**
Selects the information displayed.
- 6 ◀ (Previous)**
Selects the previous chapter/track.
- 7 ▶ (Next)**
Selects the next chapter/track.
- 8 Off**
Switches to standby.

Meridian System Remote

- | | | | | |
|--|--|---|--|---|
| <p>1 ◀◀ (Fast reverse)
Scans in reverse.
◀ Page
Previous DVD-A page.</p> <p>2 ◀ (Previous)
Selects the previous chapter/track.
Angle
Changes the camera angle.</p> <p>3 ■ (Stop)
Stops the disc.
+Function
Opens/closes the disc tray.</p> <p>4 ▶ (Play)
Plays the disc.
Audio
Changes the audio track.</p> <p>5 ▶▶ (Scan forward)
Scans forward.
Slow/Page ▶
Plays in slow motion, or next DVD-A page.</p> <p>6 ▶ (Next)
Selects the next chapter/track.
OSD
On-screen display.</p> | <p>7 (Pause)
Pauses the disc.</p> <p>8 Subtitle
Turns subtitles on/off.
+Function
Subtitle language.</p> <p>9 Source keys
Select a source.</p> | <p>10 Number keys
Select a title, chapter, or track by number.</p> <p>11 Repeat/A-B
Repeats a chapter/track or section.</p> | <p>12 Off
Switches to standby.</p> <p>13 Volume keys
Change the volume.</p> <p>14 Mute
Mutes or restores the sound.</p> | <p>15 Clear
Clears an entry.</p> <p>16 Function
Selects a special function.</p> <p>17 Top Menu
Displays the top menu.
#
Title/timecode entry.</p> <p>18 Return
Returns from a menu.</p> <p>19 Menu keys
Select or change parameters.</p> <p>20 Enter
Confirms a menu selection.</p> <p>21 Menu
Displays the disc menu.
Setup
Displays the Setup menu.</p> <p>22 Display
Changes the front-panel display.</p> |
|--|--|---|--|---|

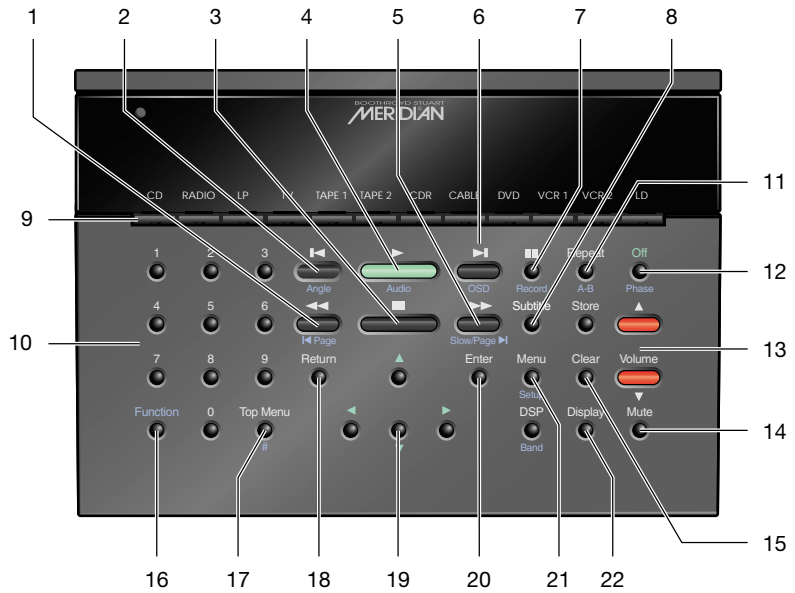

Hold down **Function** to access the functions shown in blue on the remote.

Playing a disc

During normal use the DVD player should be left in the standby state. This uses a negligible amount of electricity, but ensures that the components of the DVD player operate at maximum efficiency from the moment you start playing a disc.

If you are not going to use the DVD player for a period of several days you should switch the unit completely off, at the back panel, and disconnect it from the AC power supply.

To switch on from standby

- Press **Open**, **■**, or **▶** (front panel), or select a source on the remote.
- Switch on any other equipment connected to the CD player which is not part of the Meridian 500 Series.

The display will flash for a few seconds. The DVD player is then ready for use.

To insert a disc

- Press **Open** (front panel) or **Function ■** (remote) to open the tray.

- Place your disc, label side up, in the tray as shown below.
- Press **Open** (front panel), **Function ■** (remote) or **▶** to close the tray.

Most DVD videos start playing automatically when you close the tray.

Some DVD videos are double-sided, and need to be turned over during play.



To play the disc

- Press **▶** (front panel or remote).



The on-screen display shows  and the front-panel display shows the title and chapter, or track number:

For example, on chapter 1 of title 2:



To move to the next or previous chapter or track

- Press **▶|** or **|◀** (front panel or remote).

The on-screen display shows  or .



Note: These functions are normally disabled while the disc's copyright notice is being displayed.

To step between the pages of text or graphics on a DVD-A disc

- Press **|◀Page** (Function **◀◀** on the remote) or **Page▶|** (Function **▶▶** on the remote).

To move to the next or previous album (MP3 discs only)

- Press **▼** or **▲** (remote).

The on-screen display shows  or .

Note: Pause and fast forward/back are not available for MP3 discs.

To switch to standby

- Press **Off** (front panel or remote).

The display will show:



If you have other Meridian 500 Series equipment connected to the DVD player, these units will also switch to standby.

If a disc is currently playing, switching to standby will stop the disc, and the disc can safely be left in the unit.

Locating a specific title, chapter, or track

Normally, DVD video discs are divided into one or more titles, and the titles are subdivided into chapters. Audio CDs are divided into tracks.

The DVD player allows you to play an entire disc, or start playing from any chapter or track number. While a disc is playing you can go back to the start of the chapter or track or skip to the start of the next chapter or track.



You can also enter a specific title, chapter, or track number to locate the appropriate title or chapter/track directly.

To play starting from a particular chapter or track

- Press **▶** or **◀** (front panel or remote) to step through the track numbers until the display shows the track you want to play:

For example, to play chapter 23:



The on-screen display shows  or .

After a short delay the chapter or track you have selected will start to play.

To locate a chapter or track by number

- Press **#** (**Function Top Menu** on the remote) twice.

The on-screen display prompts for you to enter the chapter or track number:

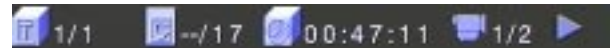

- Enter the number of the chapter (DVD) or track (audio CD) using the number keys (remote).

The number is displayed as you enter it:



- Press **▶** or **Enter** (remote).

The DVD player starts playing from the chapter or track number you specified.

To locate a title by number

- Press # (Function Top Menu on the remote).

The on-screen display prompts you to enter the title number:



- Enter the title number using the number keys (remote).
- Press ► or Enter (remote) to play from the title number you have specified.

To play from a specified timecode

- Press # (Function Top Menu on the remote) three times until the on-screen display prompts for a timecode:



- Enter the timecode using the number keys (remote).
- Press ► or Enter (remote) to play from the timecode you have specified.

Stopping, pausing, and resuming play

You can stop or pause a disc, and then resume play at the same position.

To stop play

- Press ■ (front panel or remote).

The on-screen display shows .

To resume after stopping

- Press ► (front panel or remote).

The disc will resume playing from the position where you stopped playback, and the on-screen display shows .

To pause play

- Press || (front panel or remote).

The on-screen display shows .

To step forward frame by frame

If you are playing a DVD video disc you can step forward, frame by frame, while it is paused:

- Press ||| (front panel or remote).

The on-screen display shows .

To continue after pausing

- Press ► (front panel or remote).

To return to the start of the disc

- Press ■ (front panel or remote) while the disc is stopped.

The on-screen display shows  and the disc is reset to the start.

Disc information

You can display information about a disc on the front panel or on-screen display.

To change the front panel display

- Press **Display** (front panel, or remote if the 596 is controller *).

The display will step between the following options:

<i>Display</i>	<i>Example</i>
Title and chapter numbers (DVD video disc) or track number (audio CD).	1-37
Chapter number and elapsed disc time.	37 1:17:54
Chapter number and elapsed track time.	37 0:02:54
Chapter number and remaining disc time.	37 2:31:19
Blank. Blanks all Meridian displays if the 596 is controller *.	

* To set up the 596 as controller see *To set configuration options*, page 53.

To display disc information on screen

- Press **OSD** (remote).

For a DVD video disc this shows the following information:



For an audio CD this shows the following information:



For an MP3 audio CD this shows the following information:

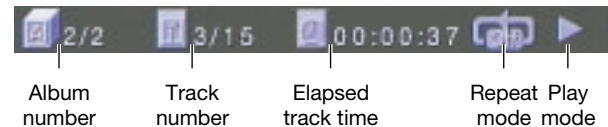

The album number is not displayed if there is only one album.

To display information about DVD video disc features

- Press OSD (remote) twice while a DVD disc is playing.

This shows the following information about DVD features:

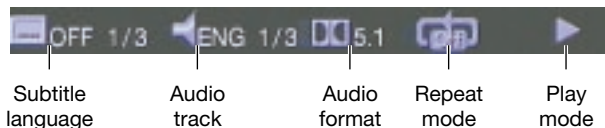

To turn off the on-screen display

- Press OSD (remote) again.

Advanced features

This chapter describes the more advanced features of the 596 DVD Player. These features are not essential if you simply want to enjoy DVD video discs or audio CDs, but they allow you to take full advantage of the range of options available with the DVD format.

Note: Many of the advanced features depend on the content of the particular DVD disc you are playing.

The advanced features described in this chapter are only available using the Meridian System Remote.

Selecting options from a menu

Many DVD video discs provide additional sections of video or special options, which you can select from an on-screen menu.

Some DVD video discs which contain several titles also provide a title menu, from which you can select one of the titles.

To select an option from the disc menu

- Press **Menu** to display the disc menu on the screen.

A typical disc menu looks like this:



- Press **▲**, **▼**, **◀**, or **▶** to highlight an option, and press **Enter** to select it.

To select a title using the title menu

- Press **Top Menu** to display the title menu on the screen.
- Press **▲**, **▼**, **◀**, or **▶** to highlight a title, and press **Enter** to select it.

The DVD player starts playback from chapter 1 of the title you selected.

Fast and slow-motion play

You can play back DVD video discs faster than normal, at between twice and eight times normal speed, or in slow motion, at between one-half and one-sixteenth of normal speed.

You can also play back audio CDs faster than normal.

Note: The sound is muted when playing back DVD video discs faster or slower than normal.

To play DVD video discs or audio CDs faster than normal

- Press **▶▶** or **◀◀** during playback.

Each time you press the key the speed switches between twice and eight times normal speed, as shown by the on-screen display: .

To play DVD video discs in slow motion

- Press **Slow (Function ▶▶)** during playback.

The speed switches between one-half, one-quarter, one-eighth, and one-sixteenth normal speed, as shown by the on-screen display: .

To resume normal speed

- Press **▶**.

Playing repeatedly

You can play back a specified title, chapter, track, or section of a disc repeatedly.

To repeat a title, chapter, or track

- Select the title, chapter, or track you want to repeat.
- Press **Repeat** to switch between **Ch.** (chapter repeat), **Title** (title repeat), and **Off** (no repeat).

The current repeat mode is displayed on the on-screen display:

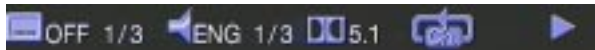

To repeat a specific section of a disc

- Press **A-B (Function Repeat)** at the beginning of the section you want to play back repeatedly.

The on-screen display shows **A-**:

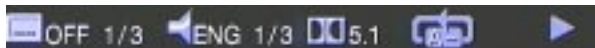

- Press **A-B** again at the end of the section.

The on-screen display shows **A-B**:

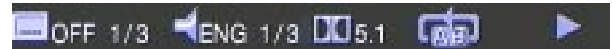

The DVD player automatically returns to the start of the section and plays it back repeatedly.

To cancel the repeat press **A-B** a third time.

Selecting a playback audio setting

You can select one of the audio soundtracks from those included on a DVD video disc during playback.

To display the current audio setting

- Press **OSD (Function ►)** twice to display the second on-screen display bar:

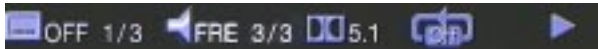

This gives the following information:

<i>Information</i>	<i>Examples</i>
Soundtrack language (when available)	ENG, FRE, GER, SPA.
Soundtrack number, and total number of soundtracks	2/3
Recording system	DD 5.1, PCM, DTS.

To select the audio setting

- Press **Audio (Function ►)**.

Each time you press **Audio** the next available soundtrack is selected.

Displaying subtitles

Many DVD video discs include subtitles in up to 32 different languages. While you are playing a disc you can turn the subtitles on or off, and select the subtitle language from those provided on the DVD video disc.

To display the current subtitle setting

- Press **OSD (Function ►)** twice to display the second on-screen display bar:

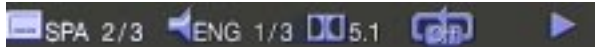

This gives the following information:

<i>Information</i>	<i>Examples</i>
Subtitle language when available	ENG, FRE, GER, SPA, OFF.
Subtitle number, and total number of languages	2/3

To select the subtitle language

- Press **Function Subtitle**.

Each time you press **Function Subtitle** the next subtitle language is selected.

To turn subtitles on or off

- Press **Subtitle**.

The on-screen displays shows the current subtitle setting:

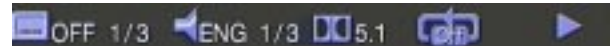

Selecting the camera angle

Some DVD video discs include scenes recorded from up to nine different camera angles, and you can select the camera angle while you are playing the disc.

To display the camera angle

- Press **OSD (Function ►)** to display the first on-screen display bar.

The camera angle icon shows the current camera angle and the total number of angles:

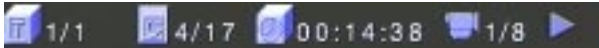

To select or change the camera angle

- Press **Angle (Function ◀)**, while viewing a scene with multiple camera angles.

Each time you press **Angle** the next camera angle is selected.

Setting the parental lock

Some DVD video discs are provided with a parental lock function to allow you to lock out playback of scenes whose content exceeds a specified rating.

To set the parental lock

- Press **Setup** (Function Menu) while the disc is stopped.

The **Setup** menu is displayed on the on-screen display:



- Press **Enter** to select **Playback options**.

The **Playback options** menu appears.

- Press **▼** to highlight **Rating** and press **Enter** to select it:

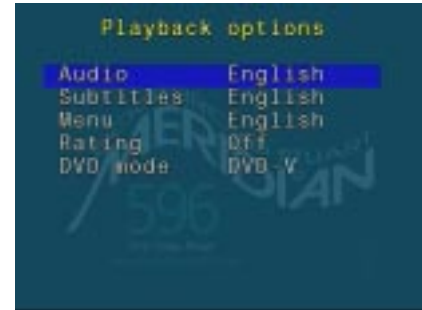

The following screen prompts you to enter the password:



- Enter your four-digit password and press **Enter**.

Initially the password is set to 7890, but you can change it to any password you choose as described in *To change the password*, opposite.

The following screen then allows you to set the rating level:



- Press ▲ or ▼ to highlight the rating level you want to set, or highlight **Off** to turn the parental lock off, and press **Enter** to select it.

Level 1 corresponds to general viewing, level 3 is equivalent to the USA movie rating PG, and level 8 corresponds to adult viewing.

The rating level you have set will be displayed in the **Playback options** menu.

To change the password

- Highlight **Change password** on the **Set rating level** screen and press **Enter** to select it.

The following screen allows you to specify the new password:



- Enter the four-digit password you want to use and press **Enter** to select it.

Note: The password cannot start with a zero.

Take care not to forget your password, or you will need to contact your Meridian dealer to reset it for you.



Setting default options

The DVD format allows disc manufacturers to provide a wide range of options on DVD video discs, and the 596 DVD Player allows you to choose between these options.

Which of these features is available depends on the DVD video disc you are playing. For information about changing these options refer to the chapter *Advanced features*, page 17.

For convenience the 596 DVD Player allows you to set a default choice for most of these options, so that when you first insert a disc it starts playing with your preferred settings. This chapter explains how to set up the default options using the DVD player's Setup menu.

The options described in this chapter are only available using the Meridian System Remote.

Setting default options

The default options are divided into the following five menus of settings:

<i>Menu</i>	<i>Description</i>
Playback options	The audio, subtitle, and menu languages.
Video setup	The display settings.
Audio setup	The sound format.
Meridian setup	Product configuration options.
Information	The region code and engineering information.

You choose the menu of settings you want from the main **Setup** menu.

To display the Setup menu

- If necessary switch on the DVD player and press **■** if a disc is currently playing.
- Press **Setup**.

The main **Setup** menu will be displayed:



To select an option from a menu

- Press ▲ or ▼ to highlight the option you want:



- Press Enter to select the option.

To return to the previous menu

- Press Return.

To exit from the setup menus

- Press Setup.

Selecting the default languages

The **Playback options** menu lets you change the default language for the audio soundtrack, subtitles, and on-screen menus, and the parental rating:

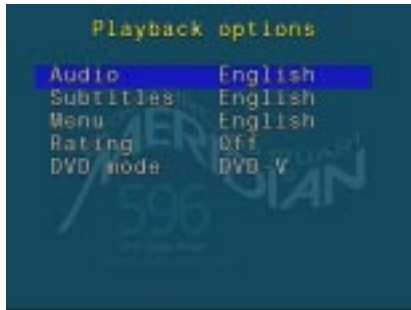

To select the default soundtrack language

Most DVD video discs include a selection of soundtrack languages. English is usually the default soundtrack language, but you can use the **Audio language** menu to set a different default language if you prefer.

- Highlight **Audio** in the **Playback options** menu, and press **Enter**.

The **Audio language** menu is displayed:

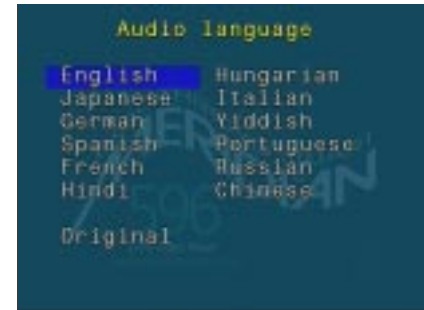

- Press **◀**, **▶**, **▲**, or **▼** to highlight the default soundtrack language you want to use, or select **Original** to choose the original soundtrack language, and press **Enter**.

To set the default subtitle language

DVD video discs can include subtitles in up to 32 different languages.

The 596 DVD Player allows you to select whether subtitles are displayed by default, and specify the preferred language if it is available on the disc.

- Highlight **Subtitles** in the **Playback options** menu, and press **Enter**.

The **Subtitle language** menu is displayed:

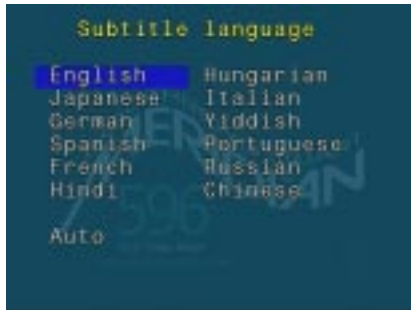

- Press **◀**, **▶**, **▲**, or **▼** to highlight the language you want to use, and press **Enter**.

Alternatively, select **Auto** to automatically display subtitles in the specified audio language if no soundtrack is available for that language.

To select the disc menu language

The 596 DVD Player allows you to choose the language for the disc menus.

- Highlight **Menu** in the **Playback options** menu and press **Enter**.

The **Menu language** menu is displayed:

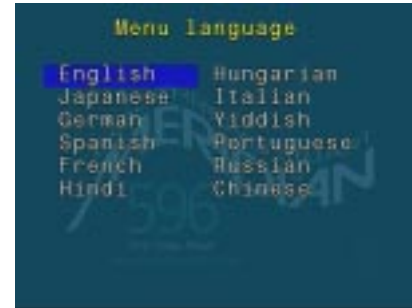

- Use **▲** or **▼** to highlight the language you want to use, and press **Enter**.

Selecting the display settings

The **Video setup** menu lets you change the video and operational settings of the 596 DVD Player:



Note: The **SCART switch** option only appears with the SCART version of the 596.

To set the default picture format

Some DVD video discs allow you to choose between the 4:3 (normal television) or 16:9 (widescreen) picture formats.

If you have a standard 4:3 television you also have the choice of displaying widescreen pictures cropped to fill your television screen (pan-scan), or with black bars above and below the picture (letterbox).

- Highlight **Display aspect** in the **Video setup** menu, and press **Enter**.

The **Display aspect ratio** menu is displayed:

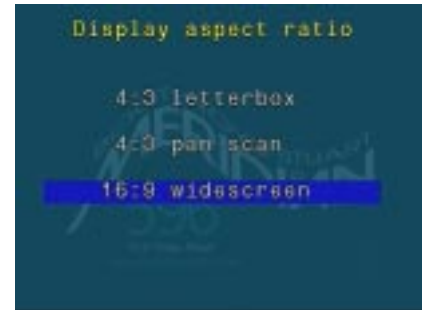

- Press **▼** or **▲** to select the format of your TV, and press **Enter**.

Note: The pan-scan feature is not available on some discs, in which case letterbox format will be used.

To select the video output format

This option should be set according to which of the S-video or COMPONENT video outputs you are using.

- Highlight **Video output** in the **Video setup** menu, and press **Enter**.

The **Video output** menu is displayed. The options depend on which version of the 596 you have; see below.

- Press **▼** or **▲** to highlight the appropriate option, and press **Enter**.

Note: The option you select will not affect the composite output, which is always available.

Component version



Choose **S**, **Y**, **RGB**, or **RGBs** to use the corresponding output.

SCART version



Choose **CVBS** or **S** to provide a composite video or S-video signal to the SCART socket. S-video is also available on the S-VIDEO OUT socket.

Choose **RGB**, **Y**, or **EURO** to provide the corresponding component video, and composite video on the SCART socket. S-video is not available with these options.

Note: The composite output is monochrome when **EURO** is selected.

NoSC is equivalent to **S** without the function select line, for two-room operation.

To select the black level

- Highlight **Black level** in the **Video output** menu, and press **Enter**.

The **Black level** menu is displayed:

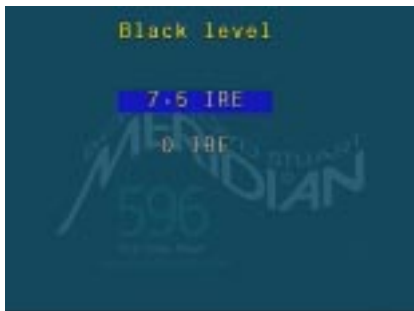

- Press **▼** or **▲** to highlight the appropriate option, and press **Enter**.

If you are using the Composite or S-video outputs of the DVD player select the 7.5 IRE option.

If you are using the Y, RGB, or SCART video outputs select the option that matches your display.

To select closed caption subtitles

Some DVD videos include closed caption subtitles, which provide a description of sound effects for the hard of hearing; for example "door creaks".

- Highlight **Closed caption** in the **Video setup** menu, and press **Enter**.

The **Closed captions** menu is displayed:



- Press **▼** or **▲** to highlight **On** or **Off**, and press **Enter**.

To select the TV standard

DVD movies are produced in both PAL and NTSC television formats. The 596 DVD Player is capable of converting between formats, to allow you to view DVD movies in either format even if your television is not capable of displaying that format. However the conversion process introduces some picture degradation, and may disable disc menu operation on some discs.

- Highlight **TV standard** in the **Video setup** menu, and press **Enter**.

The **TV standard** menu is displayed:

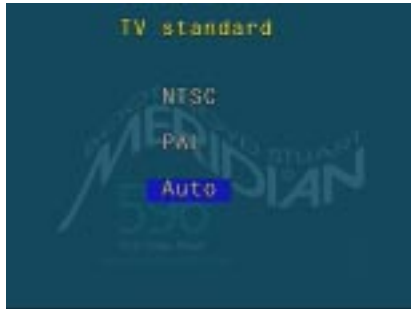

- Press **▼** or **▲** to highlight the option you want, and press **Enter**.

Choose **Auto** if your television can display both PAL and NTSC video, or choose **NTSC** or **PAL** to match the format supported by your television.

If your television is capable of displaying both formats the recommended setting is **Auto**, which supplies the unconverted video signal to the television.

A separate **Powerup std** option lets you specify the standard to be selected when you bring the 596 out of standby:



- Press **▼** or **▲** to highlight the option you want, and press **Enter**.

To select the screensaver timeouts

- Highlight **Stop timeout** or **Pause timeout** in the **Video setup** menu, and press **Enter**.

The appropriate menu is displayed:



- Press **▼** or **▲** to select the timeout delay, and press **Enter**.

The pause timeout automatically switches the 596 from pause into stop mode if no key is pressed for the specified time.

The stop timeout automatically fades the screen to black if the 596 is left in stop mode and no key is pressed for the specified time.

To set up SCART switching

This option determines how the 596 controls the SCART switch output (pin 8), which usually switches a television or monitor to display the SCART output.

- Highlight **SCART switch** in the **Video setup** menu, and press **Enter**.

The **SCART switch** menu is displayed:



- Press **▼** or **▲** to highlight the appropriate option, and press **Enter**.

When playing activates the output when the 596 plays a video disc or is put into setup, and it remains active until the 596 is put into standby.

By Source activates the output for sources which have the **SCART switch** option set to **On** in the **Source configuration** menu. This allows you to set up a separate CD source which does not affect the television or monitor. For more information see *To set configuration options*, page 53.

Selecting the audio settings

The **Audio setup** menu lets you select the 596 audio settings:



The **Digital audio format** menu is displayed:



To select the digital audio format

- Highlight **Digital format** in the **Audio setup** menu, and press **Enter**.

- Press **▼** or **▲** to highlight the format you want, and press **Enter**.

Choose **Bitstream** if you are connecting the 596 DVD Player to an external digital surround processor.

Choose **PCM** to use the 596 on-board decoder to provide two channel PCM audio on the digital output, suitable for feeding to a digital preamplifier or DSP loudspeakers.

Note: The analogue outputs are not affected by this setting.

To select the audio output rate

- Highlight **96kHz enable** in the **Audio setup** menu, and press **Enter**.

The following menu is displayed:



- Press **▼** or **▲** to highlight the option you want, and press **Enter**.

Only choose **Yes** if your digital surround processor is capable of decoding a 96kHz input.

To select Meridian High Resolution

- Highlight **MHR** in the **Audio setup** menu, and press **Enter**.

The following menu is displayed:



- Press **▼** or **▲** to highlight the option you want, and press **Enter**.

If you are using the 596 with other Meridian equipment that supports MHR, the recommended setting is **On**, which uses MHR for all sources. Otherwise you should select **Off**.



Setting up the DVD player

This chapter explains how to install the DVD player. It describes what you should find when you unpack the DVD player, how you should connect it to your other audio equipment, and the siting constraints.

You should not make any connections to the DVD player or to any other component in your system whilst the AC power supply is connected and switched on.

Unpacking

The 596 DVD Player comes in a box containing the following components:

- Meridian 596 DVD Player.
- Meridian System Remote.
- Meridian comms lead.
- Power cord.
- This manual.

If any of these items are missing please contact your dealer. We suggest that you retain the packing in case you need to transport the unit.

Radio interference

FCC Warning: This equipment generates and can radiate radio frequency energy and if not installed and used correctly in accordance with our instructions may cause interference to radio communications or radio and television reception. It has been type-tested and complies with the limits set out in Subpart J, Part 15 of FCC rules for a Class B computing device. These limits are intended to provide reasonable protection against such interference in home installations.

EEC: This product has been designed to comply with the limits set out in EN55013 and EN55020C.



Positioning the DVD player

Safety warnings

- Do not expose the unit to dripping or splashing.
- Do not place any object filled with liquid, such as a vase, on the unit.
- Do not place naked flame sources, such as lighted candles, on the unit.

To avoid overheating

Do not position the DVD player:

- In direct sunlight.
- Near heat sources, such as a radiator.
- Directly on top of heat producing equipment, such as a power amplifier.

Ensure that air can flow through the cooling slots on the base and top cover.

To avoid interference

Do not position the DVD player:

- Near strong magnetic radiation, such as near a power amplifier.
- Near to a television, or where connecting cables may be subject to or cause interference.

Back panel

Component version

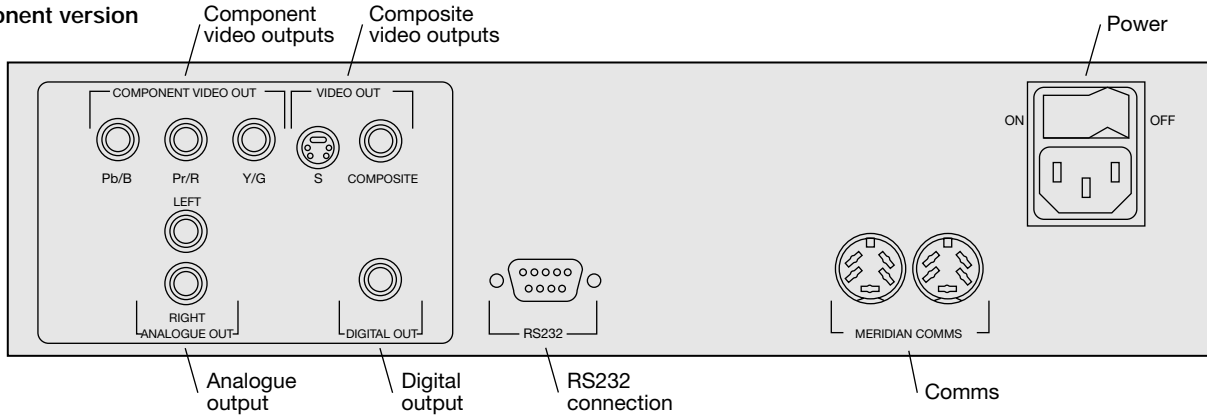

SCART version

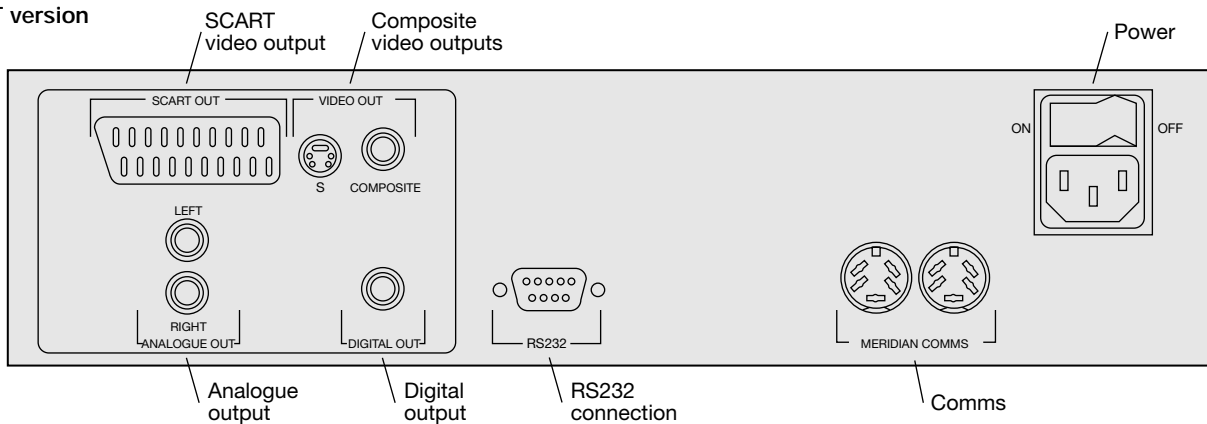

Video connections

The DVD player provides three alternative video outputs to provide flexibility in connecting it to other equipment.

If your other equipment provides component video inputs, use these to produce the highest possible video quality.

The video connections should be made using suitable video cables, which are available from your dealer.

<i>Use this output</i>	<i>To connect to this</i>
COMPONENT	Component version only: A monitor or projection television with component video inputs.
SCART	SCART version only: Component, S-video, or composite video inputs, depending on the option selected in the Video output menu.
S-VIDEO OUT	A monitor or television with an S-video input, or a Meridian 562V.2 Multimedia Controller.
COMPOSITE	A television or monitor with a composite video input, or the composite video input on a Meridian 562V or 562V.2.

Audio connections

The following table gives details of the two alternative audio outputs:

<i>Use this output</i>	<i>To connect to this</i>
DIGITAL OUT	A surround processor such as the Meridian 561 Digital Surround Processor, a digital preamplifier such as the Meridian 562V, or Meridian DSP loudspeakers.
ANALOGUE OUT	A television, analogue preamplifier such as the Meridian 502, or an analogue surround processor such as the Meridian 541 Surround Controller.

The digital connections should be made with high quality 75Ω screened cable. Suitable cables are available from Meridian. We do not recommend using audio cables which do not have adequate shielding or the correct impedance, or cables intended for UHF applications, as these do not provide adequate shielding in the 1–30MHz region.

The analogue connections should be made using high-quality screened cable, taking care to connect the left and right channels correctly.

Communications connections

The following table gives details of the communications connections:

<i>Use this connection</i>	<i>To connect to this</i>
COMMS	Other Meridian 500 series equipment, or Meridian DSP loudspeakers.
RS232 connection	For future expansion, to allow the 596 to be interfaced to a computer. Contact your dealer for more information.

Connecting video

Connecting using component video

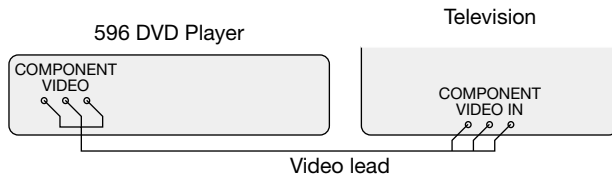

If your television, monitor, or projection system includes component video inputs, these will give the highest possible quality from DVD videos.

- Connect the appropriate component outputs from the 596 DVD Player to the component video inputs, using suitable video cables.
- Set the **Video output** menu option to the appropriate option; see *To select the video output format*, page 32.

Connecting using S-video

- Connect the S-video output to a corresponding input on a television, monitor, or video control unit, using a suitable S-video cable.

The S-video output is recommended if your other equipment provides a choice of both S-video and composite inputs.

- Leave the **Video output** menu option set to **S**; see *To select the video output format*, page 32.

Connecting using composite video

- Connect the composite video output to a corresponding input on a television, monitor, or video control unit using a suitable cable.

The composite video output is always active, irrespective of the **Video output** setting.

Connecting audio

To connect to a Meridian 561 Digital Surround Processor

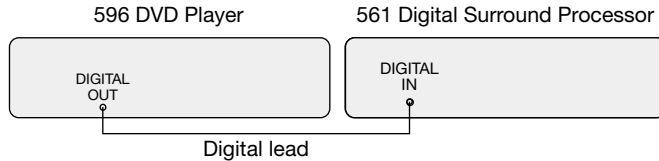

- Connect the DIGITAL OUT on the 596 to the DIGITAL IN on the 561.
- Set the **Digital format** menu option to **Bitstream**; see *To select the digital audio format*, page 38.

To connect to a preamplifier (eg Meridian 502 Analogue Controller)

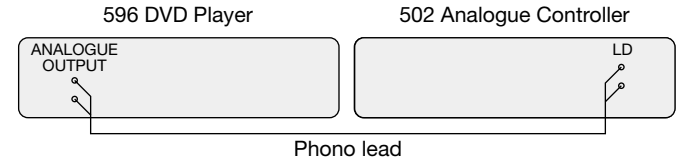

- Connect the ANALOGUE OUT connections from the 596 DVD Player to a suitable pair of audio inputs on the preamplifier, such as the CD or LD inputs.

To connect to Meridian DSP loudspeakers

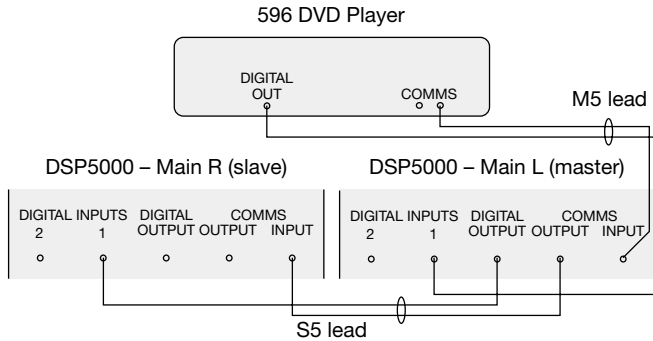

- Connect the DIGITAL OUT from the 596 DVD Player to DIGITAL INPUT 1 on the master DSP loudspeaker.
- Connect the DIGITAL and COMMS output from the left DSP loudspeaker to the DIGITAL and COMMS INPUTS on the slave DSP loudspeaker, using an S5 lead.
- Leave the **Digital format** menu option set to **PCM**; see *To select the digital audio format*, page 38.

Connecting to other Meridian equipment

To connect to other Meridian 500 Series equipment

- Connect one of the COMMS sockets on the back panel of the DVD player to one of the COMMS sockets on another 500 Series unit, using the 500 comms lead provided with the 596 DVD Player.

The sequence in which you connect the units is not important.

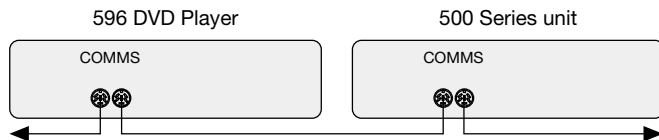

Then configure the units with the following automatic setup procedure:

- Switch all the units to standby.
- Press Clear (remote).

Each unit will display:

Auto

One unit will then be designated as the controller, and display:

Controller

This is the unit that will respond to the remote.

All the other units will be configured as non-controllers, and display:

Not Con.

Your system is now set up and ready for use.

- If for any reason the automatic setup does not give the configuration you want, restore the default operation by selecting one of the standard types; see *Choosing standard settings*, page 52.

Note: Do not, under any circumstances, connect any equipment other than Meridian 500, 600, or 200 Series to the socket marked COMMS on the back of the DVD player.

Configuring the DVD player

Many advanced aspects of the 596 DVD Player can be configured to alter the way it operates with the other Meridian equipment in your system.

These settings are initially set to standard values, which are suitable for most situations, and this chapter describes how to restore the standard settings.

It then gives details of the more advanced settings and explains how to change them.

Choosing standard settings

The DVD player provides three standard settings, called Types, which configure the 596 into the most commonly needed configurations.

Choosing one of the three Types overrides any other configuration you may have performed, and so can be used to reset the configuration of the unit.

The types are summarised in the following table:

<i>Type</i>	<i>Video</i>	<i>Audio</i>	<i>MHR</i>
0	S-video	PCM 96kHz	Auto
1	S-video	Bitstream 96kHz	Auto
2	S-video	Bitstream 96kHz	On

To restore the standard settings

- Switch the 596 to standby.
- Hold down **Off** (front panel).

After a short delay the display will show:



- Press **◀** or **▶** on the front panel to change the Type number.

For example, if you select Type 1 the display shows:



- Wait until the display shows:



The display then shows:



- Press **Off** to switch back to standby.
- Switch on again to use the 596 with the standard setting you have selected.

Configuring the 596 DVD Player

To configure specific options

- Highlight **Meridian setup** in the **Setup** menu, and press **Enter**.

The **Meridian setup** menu will be displayed:



To set configuration options

The configuration options are generally set to an appropriate value when you reset the 596 to the standard settings, and you should not normally need to alter them; see *Choosing standard settings*, page 52.

The options are summarised in the following table for advanced use:

<i>Option</i>	<i>Default</i>	<i>Description</i>
Diagnostics	No	Set to Yes for a diagnostic display on the front-panel display.
System address	1	Set to a value from 1 to 8.
Product address	1	Set to a value from 1 to 8.
Controller	Auto	Specifies whether the DVD player is controller, not controller, or set automatically.
Start source	DVD	Specifies which source is selected when switching on from standby.
Vol display	No	Specifies whether the DVD player displays the volume for the system.
Fan	As required	Set to Always to keep the fan permanently on, or As required to use it when necessary.
Source config		Allows you to configure the sources; see below.

To configure the sources

If you are using the 596 DVD Player as the controller in your Meridian system, you can use the **Source config** option on the Meridian **Setup** menu to configure each of the sources in your system.

- Highlight **Source config** in the Meridian **Setup** menu, and press **Enter**.

The **Source configuration** menu is displayed:



For each source you want to configure:

- Press the source key on the remote corresponding to the source you want to configure.

The **Category**, **Address**, and **SCART switch** options show the current values defined for that source. The **SCART switch** option only appears with the SCART version of the 596.

To change any option:

- Highlight the corresponding option in the **Source configuration** menu and press **Enter**, select the value you want to use, and press **Enter** to select it.

The **Category** identifies the type of Meridian product selected by the corresponding source. Specify **-C** for the current product, **1C** for a Meridian CD player, **2C** for a Meridian tuner, **3C** for another Meridian DVD player, or **NC** for a non Meridian product such as a TV.

Normally the **Address** should be set to 1A. However if you have more than one Meridian product of the same type in your system you can use different source keys to select between them by assigning them different addresses. For example if you have two Meridian DVD players, assign one of them address 1A and the other address 2A.

For information about using the **SCART switch** option see *To set up SCART switching*, page 36.

Troubleshooting

This chapter provides suggested solutions to typical problems that may occur when setting up or using the DVD player.

If you are still not able to resolve a difficulty with the help of this guide and the suggestions in the following pages, please contact your Meridian dealer or Meridian Audio Ltd.

Troubleshooting

No lights are displayed when switching on

- Check that your AC power supply is connected correctly.
- Check that the ON/OFF switch on the back panel is in the ON position.

There is no sound when playing a disc

- Check that your preamplifier is switched on, and the volume is at an appropriate level.
- Check that the DVD player is connected correctly to the other components of your system; see *Setting up the DVD player*, page 41.
- Check that the correct source has been selected on your preamplifier.
- Try playing another disc. If this disc works, check the problem disc for signs of dirt or damage.
- If you are using the DVD player with a preamplifier or active loudspeakers check that the **Digital audio format** menu option is set to **PCM**; see *To select the digital audio output format*, page 38.

There is interference on the radio and/or television when the DVD player is switched on

Before following the steps below, ensure all units are switched off.

If this equipment does cause or suffer from interference to/from radio or television reception then the following measures should be tried:

- Reorient the receiving aerial (or antenna) or route the antenna cable of the receiver as far as possible from the 596 DVD Player and its cabling.
- Ensure that the receiver uses well-screened antenna cable.
- Relocate the receiver with respect to the DVD player.
- Connect the receiver and this product to different AC outlets.

The video picture is monochrome

If you are using the S-Video output, make sure that **S** is selected in the **Video output** menu

Otherwise, check your video cabling.

The video picture is bright blue or pink

If you are using the Component outputs, check that the **Y** option is selected in the **Video output** menu; see *To select the video output format*, page 32.

Otherwise, check your video cabling.

Picture whites appear green

- Check that **RGB** is selected in the **Video output** menu; see *To select the video output format*, page 32.

The on-screen display shows PLEASE CHECK DISC when attempting to play a disc

- Check that the disc is positioned correctly in the drawer; see *To insert a disc*, page 10.
- If it is a single-sided disc check that the label is uppermost.
- Try playing another disc. If this disc works, check the problem disc for signs of dirt or damage.

The on-screen display shows WRONG REGION CODE

This screen is displayed if you attempt to play a DVD video disc encoded for a region that is not supported by your DVD player:



A question-mark symbol is displayed on the on-screen display

This indicates that the function you have selected is not available on the disc you are playing.

The pause timeout automatically switches the 596 from pause into stop mode if no key has been pressed for the specified time.

The stop timeout automatically fades the screen to black if the 596 is left in stop mode and no key has been pressed for the specified time.

Creating MP3 discs

MP3 discs can be created from a computer using appropriate MP3 encoding software and a CD-ROM writer.

Generate the MP3 files with a data rate of at least 128 Kbits per second. Group the tracks into folders to create separate albums on the disc. Do not create folders within the folders.

Tracks and albums are played in the order in which they are recorded onto the CD-ROM. Usually this will be in alphabetical order of filename.

Maintenance

Cleaning

When cleaning the DVD player bear in mind that the front of the DVD player is plastic, and the display panel and lid are glass.

Disconnect the power cord before cleaning the unit.

Note: Do not use abrasive cleaners on any part of the DVD player.

To clean the case, display panel, and keypad

- Use a slightly damp cloth.

Ensure that no water is allowed to get inside the case, and do not reconnect the power until you are certain that the DVD player is completely dry.

To clean the audio and video connections

The audio and video sockets on the back of the DVD player are gold-plated and need no cleaning if gold-plated phono plugs are

used. Otherwise, it is recommended that you unplug and reconnect the plugs at least once a year. A proprietary contact cleaner can be used to some advantage.

The electrical digital output should be treated in a similar way.

To change the mains fuse

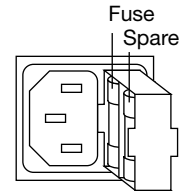

- Remove the mains connector, and pull out the drawer next to the power input to access the fuses.

Before replacing a blown fuse, it is best to ascertain the cause of the failure.

The fuse drawer includes a spare fuse. This should be replaced by a fuse of the same rating.

Service and guarantee

Service

The Meridian 500 Series of hi-fi components have been carefully designed to give years of untroubled service. There are no user-serviceable parts inside the case, nor do the units require any form of maintenance.

In the unlikely event that your DVD player fails to function correctly, it should be returned, in its original packaging, to your Meridian dealer.

In case of difficulty within the UK or USA please contact the appropriate sales and service address shown on page ii.

In case of difficulty outside the UK or USA, contact the importing agent for the territory. A list of Meridian agents outside the UK is available from Meridian Audio.

No responsibility can be accepted for the DVD player whilst in transit to the factory or an agent, and customers are therefore advised to insure the unit. When seeking service under guarantee, proof of the date of purchase will be required.

Guarantee

The 596 DVD Player is guaranteed against defects in material and workmanship for 2 years from the date of purchase.

The guarantee is void if the 596 DVD Player has been subject to misuse, accident, or negligence, or has been tampered with or modified in any way without the written authorisation of Meridian Audio Limited. Note that connecting anything other than the correct network lead to the COMMS sockets may cause damage to the 596 DVD Player which will not be covered by this guarantee. Attempted servicing by unauthorised people may also invalidate this guarantee. Labour and carriage charges are not covered unless by local agreement.

Outside the UK, local warranty liability is restricted to equipment purchased within the territory. Our agents outside the UK are only under contractual obligation to service under-guarantee equipment sold through them. They are entitled to make a non-refundable charge for any service carried out on other equipment.

This guarantee does not limit your statutory rights within the United Kingdom.

Index

- A**
 - A-B (remote) 20
 - accessories 6
 - advanced features 17
 - ANALOGUE OUT 46
 - audio CDs 12
 - on-screen display 15
 - audio connections 46, 48
 - Audio language menu 30
 - audio output rate, selecting 39
 - audio settings 21
 - Audio setup menu 38
 - automatic setup 50
- B**
 - back panel 44
 - Bitstream option 38
 - Black level menu 34
- C**
 - camera angle, selecting 23
 - changing the display 15
 - chapters 12
 - moving to next/previous 12
 - selecting by number 12
 - choosing standard settings 52
 - cleaning 59
 - closing the tray 10
- COMMS connection** 46
- communications connections** 46
- COMPONENT outputs** 45
- component video, connecting** 47
- components** 42
- composite output** 45
- composite video, connecting** 47
- configuring the DVD player** 53
- connecting**
 - audio 48
 - to Meridian 500 Series equipment 50
 - video 47
- connections**
 - audio 46
 - communications 46
 - video 45
- continuing after pausing** 14
- controller mode config option** 53
- Controller, setting** 50
- D**
 - default options, setting 27
 - digital audio formats 38
 - Digital audio format menu 38
 - DIGITAL OUT 46
 - disc information 15
 - Disc menu 18
 - display
 - flashing 10
 - front panel 15
 - on-screen 16
 - Display aspect ratio menu 32
 - displaying disc information 15
 - DVD information, displaying 16
 - DVD video discs 12, 18
 - camera angle 23
 - on-screen display 15
- F**
 - fast play 19
 - flashing display 10
 - front panel controls 8
 - front panel display 15
 - fuse, replacing 59
- G**
 - guarantee 60
- I**
 - Information menu 28
 - inserting a disc 10
 - introduction 1

-
- L** language
 - screen displays 31
 - subtitles 30
 - letterbox format 32
 - locating a specific title, chapter, or track 12
 - M** maintenance 59
 - Menu language menu 31
 - menu, on-screen 18
 - Meridian 500 Series 2
 - 562V Multimedia Controller 4
 - communications 2
 - Meridian 500 Series operation, setting 50
 - Meridian 565 Digital Surround Processor, connecting 48
 - Meridian Digital Music System 4
 - Meridian Digital Theatre™ 3
 - Meridian DSP loudspeakers, connecting to 49
 - Meridian setup menu 28
 - Meridian System Remote 7
 - MHR option 39
 - MP3 discs** 11
 - moving between albums 11
 - creating 58
 - O** on-screen display 15, 16
 - disc information 15
 - DVD information 16
 - opening the tray 10
 - outputs 44
 - audio 46
 - SCART 44, 45
 - video 45
 - P** pan-scan 32
 - parental lock, setting 24
 - pausing play 14
 - PCM option 38
 - picture format 32
 - Playback options menu 30
 - playing 11
 - a specific chapter or track 12
 - a specific title 13
 - faster than normal 19
 - from a specified timecode 13
 - in slow motion 19
 - preamplifier, connecting to 48
 - R** radio interference 42
 - repeating
 - a specific section of a disc 20
 - a title, chapter, or track 20
 - RS232 connection 46
 - S** S-video
 - connecting 47
 - output 45
 - safety warnings 43
 - sample configurations
 - Meridian Digital Music System 4
 - Meridian Digital Theatre™ 3
 - SCART
 - output 44, 45
 - switching 36, 54
 - screensaver timeouts 36
 - service 60
 - setting up the DVD player 41
 - Setup menu 28
 - slow-motion play 19
 - soundtracks
 - language 30

-
- soundtracks (*continued*)
 - selecting 21
 - specification 5
 - standard settings 52
 - choosing 52
 - standby 10
 - switching on from 10
 - switching to 11
 - stepping forward frame by frame 14
 - stopping play 14
 - Subtitle language menu 31
 - subtitles
 - closed caption 34
 - default language 30
 - displaying 22
 - turning on or off 22
 - switching on from standby 10
 - switching to standby 11
 - T** timecode, playing from 13
 - titles 12
 - locating by number 13
 - selecting from the Title Menu 18
 - Top menu 18
 - tracks 12
 - locating by number 12
 - moving to next/previous 12
 - tray, opening and closing 10
 - troubleshooting 55
 - TV standard, selecting 35
- U** unpacking 42
- V** ventilation 43
- video connections 45, 47
 - Video setup menu 28, 32
- W** WRONG REGION CODE 57

