



OPERATOR'S MANUAL



21" MULCHING PUSH
MOWER
MODEL NO:
LC-436

IMPORTANT: READ SAFETY RULES AND INSTRUCTIONS CAREFULLY

Warning: This unit is equipped with an internal combustion engine and should not be used on or near any unimproved forest-covered, brush-covered or grass-covered land unless the engine's exhaust system is equipped with a spark arrester meeting applicable local or state laws (if any). If a spark arrester is used, it should be maintained in effective working order by the operator. In the State of California the above is required by law (Section 4442 of the California Public Resources Code). Other states may have similar laws. Federal laws apply on federal lands. A spark arrester for the muffler is available through your nearest engine authorized service dealer or contact the service department, P.O. Box 361131 Cleveland, Ohio 44136-9722.

WHITE OUTDOOR PRODUCTS COMPANY P.O. BOX 361131 CLEVELAND, OHIO 44136-9722

PRINTED IN U.S.A.

FORM NO. 770-10059
(10/98)

Table of Contents

Content	Page
Finding Model Number	2
Warranty	2
Safe Operation Practices	3
Slope Gauge	5
Unpacking	6
Setting Up Mower	6
Controls	9
Operation	10
Lubrication	11
Maintenance	11
Service & Adjustments	12
Off-Season Storage	15
Trouble-Shooting Guide	16
Parts List	17

SECTION 1: FINDING MODEL NUMBER

This Operator's Manual is an important part of your new lawn mower. It will help you assemble, prepare and maintain your lawn mower. Please read and understand what it says.

Before you start to prepare your lawn mower for its first use, please locate the model plate and copy the information from it in this Operator's Manual. The information on the model plate is very important if you need help from your dealer or the Customer Dealer Referral Line.

- Every lawn mower has a model plate. You can locate it by standing behind the unit in the operating position and looking down at the cutting deck. A sample model plate is shown below.

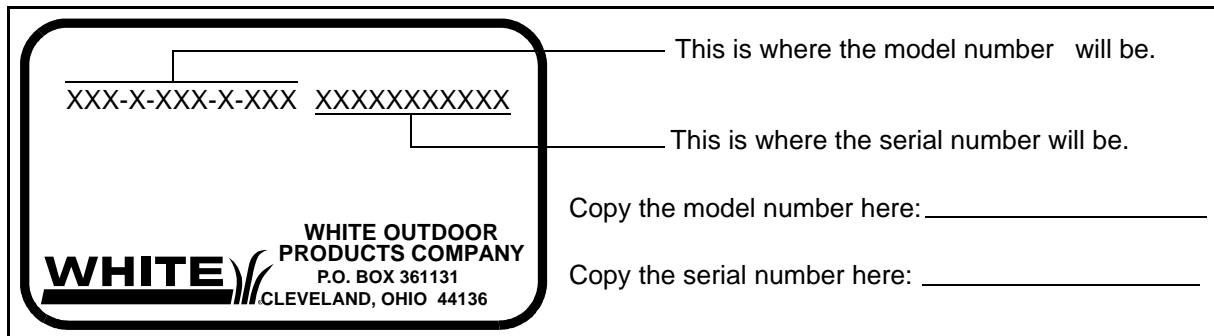

SECTION 2: CALLING WARRANTY SERVICE

- **Locate your rider's model number and serial number** — Record this information in the space provided above. To find your unit's specific model number and serial number, see previous section.
- If you are having difficulty assembling this product or if you have any question regarding the controls, operation or maintenance of this unit, please call the Customer Dealer Referral Line. You can reach them by calling:

1-800-949-4483

- Before calling your local dealer, make sure that you have your unit's model and serial numbers ready. By having this information handy, you help your local dealer give you faster service. To find your unit's model and serial number, see previous section.

SECTION 3: IMPORTANT SAFE OPERATION PRACTICES



This symbol points out important safety instructions which, if not followed, could endanger the personal safety and/or property of yourself and others. Read and follow all instructions in this manual before attempting to operate your lawn mower. Failure to comply with these instructions may result in personal injury. When you see this symbol—**heed its warning.**



DANGER: Your lawn mower was built to be operated **according to the rules for safe operation in this manual.** As with any type of power equipment, carelessness or error on the part of the operator can result in serious injury. **If the operator violates any of these rules, he/she may cause serious injury to himself/herself or others.**

1. GENERAL OPERATION

- Read this owner's guide carefully in its entirety before attempting to assemble this machine. Read, understand, and follow all instructions on the machine and in the manual(s) before operation. Be completely familiar with the controls and the proper use of this machine before operating it. Keep this manual in a safe place for future and regular reference and for ordering replacement parts.
- Your rotary mower is a precision piece of power equipment, not a plaything. Therefore, exercise extreme caution at all times. Your unit has been designed to perform one job: to mow grass. Do not use it for any other purpose.
- Never allow children under 14 years old to operate a power mower. Children 14 years old and over should only operate mower under close parental supervision. Only responsible individuals who are familiar with these rules of safe operation should be allowed to use your mower.
- Keep the area of operation clear of all persons, particularly small children and pets. Stop engine when they are in the vicinity of your mower to help prevent blade contact or thrown object injury. Although the area of operation should be completely cleared of foreign objects, an object may have been overlooked and could be accidentally thrown by the mower in any direction and cause serious personal injury to the operator or any others allowed in the area.
- Thoroughly inspect the area where the equipment is to be used. Remove all stones, sticks, wire, bones, toys and other foreign objects which could be picked up and thrown by the mower in any direction and cause serious personal injury to the operator or any others allowed in the area. Plan your mowing pattern to avoid discharge of material toward roads, sidewalks, bystanders and the like. To help avoid a thrown object's injury, keep children, bystanders and helpers at least 75 feet from the mower while it is in operation.
- Always wear safety glasses or safety goggles during operation or while performing an adjustment or repair, to protect eyes from foreign objects that may be thrown from the machine in any direction.
- Wear sturdy, rough-soled work shoes and close-fitting slacks and shirts. Shirts and pants that cover the arms and legs and steel-toed shoes are recommended. Do not wear loose fitting clothes or jewelry. They can be caught in moving parts. Never operate a unit in bare feet, sandals, or sneakers.
- Do not put hands or feet near or under rotating parts. Keep clear of discharge opening at all times as the rotating blade can cause injury.
- Many injuries occur as a result of the mower being pulled over the foot during a fall. Do not hang on to the mower if you are falling; release the handle immediately.
- Never pull the mower toward you while you are walking. If you must back the mower away from a wall or obstruction first look down and behind, and then follow these steps:
 - Step back from the mower to fully extend your arms.
 - Be sure you are well balanced with sure footing.
 - Pull the mower back slowly, no more than half way toward you.
 - Repeat these steps as needed.
 - Do not operate the mower while under the influence of alcohol or drugs.
 - The blade control handle is a safety device. Never attempt to bypass its operation. Doing so makes the safety device inoperative and may result in personal injury through contact with the rotating blade. The blade control handle must operate easily in both directions and automatically return to the disengaged position when released.
 - Never operate the mower in wet grass. Always be sure of your footing. A slip and fall can cause serious personal injury. Keep a firm hold on the handle and walk, never run. Mow only in daylight or in good artificial light.
 - Stop the blade when crossing gravel drives, walks or roads.
 - If the equipment should start to vibrate abnormally, stop the engine and check immediately for the cause. Vibration is generally a warning of trouble.
 - Shut the engine off and wait until the blade comes to a complete stop before removing the grass catcher or unclogging the chute. The cutting blade continues to rotate for a few seconds after the engine is shut off. Never place any part of the body in the blade area until you are sure the blade has stopped rotating.
 - Never operate mower without proper guards, grass catcher, plates or other safety protective devices in place.
 - Muffler and engine become hot and can cause a burn. Do not touch.
 - Only use accessories approved for this machine by the manufacturer. Read, understand, and follow all instructions provided with the approved accessory.
- If situations occur which are not covered in this manual, use care and good judgment. Contact your dealer for assistance.
- Do not adjust the throttle control with the engine running.

2. SLOPE OPERATION

For your safety, use the slope gauge included as part of this manual to measure slopes before operating this unit on a sloped or hilly area. If the slope is greater than 15 degrees as shown on the slope gauge, do not operate this mower.

DO:

- Mow across the face of slopes; never up and down. Exercise extreme caution when changing direction on slopes.
- Watch for holes, ruts, hidden objects, or bumps. Tall grass can hide obstacles.
- Always be sure of your footing. A slip and fall can cause serious personal injury. If you feel you are losing your balance release the blade control handle immediately and the blade will stop in less than 3 seconds.

DO NOT:

- Do not mow near drop-offs, ditches or embankments. The operator could lose footing or balance.
- Do not mow slopes greater than 15 degrees as shown on the slope gauge.
- Do not mow on wet grass. Reduced footing could cause slipping.

3. CHILDREN

Tragic accidents can occur if the operator is not alert to the presence of children. Children are often attracted to the mower and the mowing activity. Never assume that children will remain where you last saw them.

- Keep children out of the mowing area and under the watchful care of a responsible adult other than the operator.
- Be alert and turn mower off if a child enters the area.
- Before and while moving backwards, look behind and down for small children.
- Never allow children under age 14 to operate the mower.
- Use extreme care when approaching blind corners, shrubs, trees, or other objects that may obscure your vision of a child or hazard.

4. SERVICE

- Use extreme care in handling gasoline and other fuels. They are extremely flammable and the vapors are explosive.
- Use only an approved gasoline container.
- Never remove gas cap or add fuel while the engine is running. Allow engine to cool at least two minutes before refueling.
- Replace gasoline cap securely and wipe off any spilled gasoline before starting the engine as it may cause a fire or explosion.
- Extinguish all cigarettes, cigars, pipes and other sources of ignition.
- Never refuel machine indoors because flammable vapors will accumulate in the area.
- Never store the machine or fuel container inside where there is an open flame or spark such as a gas water heater, space heater, or furnace.
- Never run an engine inside a closed area.
- To reduce fire hazard, keep mower free of grass, leaves, or other debris build-up. Clean up oil or fuel spillage. Allow mower to cool at least 5 minutes before storing.
- Before cleaning, repairing, or inspecting, make certain the blade and all moving parts have stopped. Disconnect the spark plug wire, and keep the wire away from the spark plug to prevent accidental starting.
- Check the blade and engine mounting bolts at frequent intervals for proper tightness. Also, visually inspect blade for damage (e.g., bent, cracked). Replace with blade which meets original equipment specifications.

- Keep all nuts, bolts, and screws tight to be sure the equipment is in safe working condition.
- Never tamper with safety devices. Check their proper operation regularly.
- After striking a foreign object, stop the engine, remove the wire from the spark plug, and thoroughly inspect the mower for any damage. Repair the damage before starting and operating the mower.
- Never attempt to make a wheel or cutting height adjustment while the engine is running.
- Grass catcher components are subject to wear, damage and deterioration, which could expose moving parts or allow objects to be thrown. For safety protection, frequently check components and replace with manufacturer's recommended parts, when necessary.
- Mower blades are sharp and can cut. Wrap the blade(s) or wear gloves, and use extra caution when servicing them.
- Do not change the engine governor setting or overspeed the engine. Excessive engine speeds are dangerous.

Your Responsibility

- Restrict the use of this power machine to persons who read, understand and follow the warnings and instructions in this manual and on the machine.
- Following are representations of the safety labels on your lawn mower. Maintain safety while operating the mower.



SECTION 4: SLOPE GAUGE

Use this page as a guide to determine slopes where you may not operate safely.

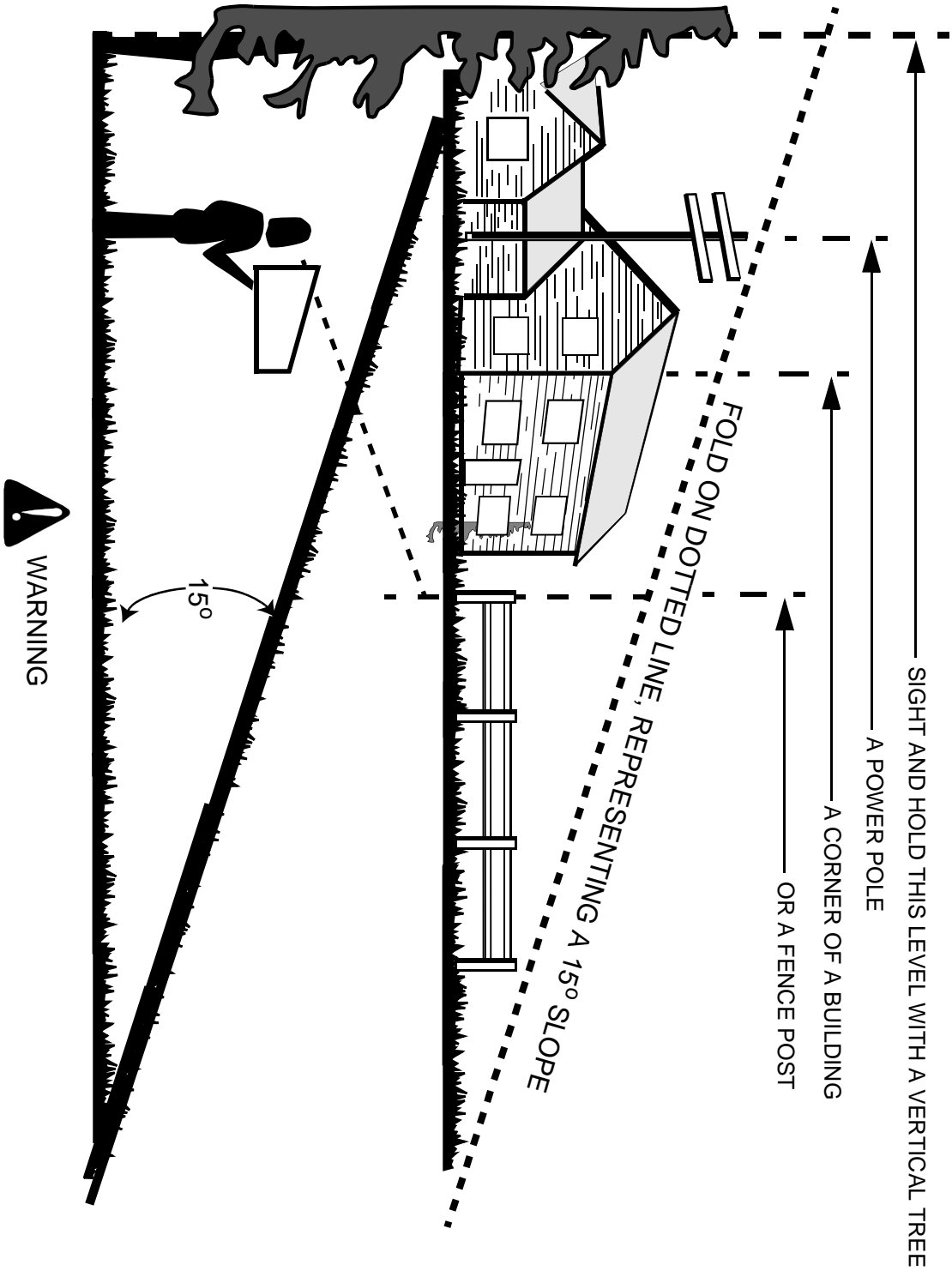

Do not mow on inclines with a slope in excess of 15 degrees (a rise of approximately 2-1/2 feet every 10 feet). A riding mower could overturn and cause serious injury. If operating a walk-behind mower on such a slope, it is extremely difficult to maintain your footing and you could slip, resulting in serious injury.

Operate RIDING mowers up and down slopes, never across the face of slopes.

SECTION 5: UNPACKING

Removing Unit From Carton

- Remove staples, break glue on top flaps, or cut tape at carton end and peel along top flap to open carton.
- Remove loose parts if included with unit (i.e., owner's manual, etc.). See Figure 1.

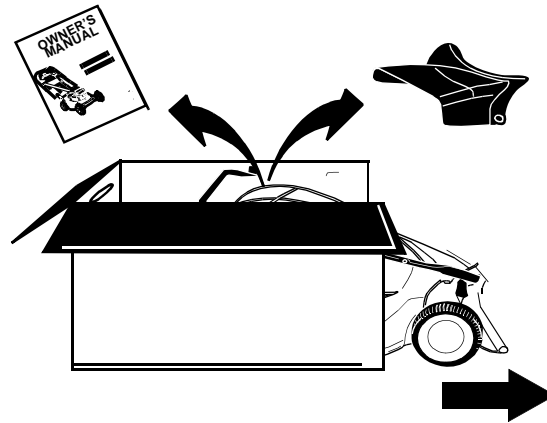

FIGURE 1

- Cut along dotted lines and lay carton down flat. Remove packing material.
- Roll or slide unit out of carton. Check carton thoroughly for loose parts. See Figure 1.

NOTE: Make sure not to crimp the cables while removing the loose parts or the entire unit from the carton.

NOTE: Reference to right or left hand side of the mower and/or front or behind the mower is observed from the operating position.

SECTION 6: SETTING UP MOWER

Tools Required

- Pair of Pliers
- Funnel

Disconnecting Spark Plug

- Before setting up your lawn mower, disconnect the spark plug wire from the spark plug, and ground it against the engine. See Figure 2.
- Attach rubber boot to a bolt on the engine to ground.

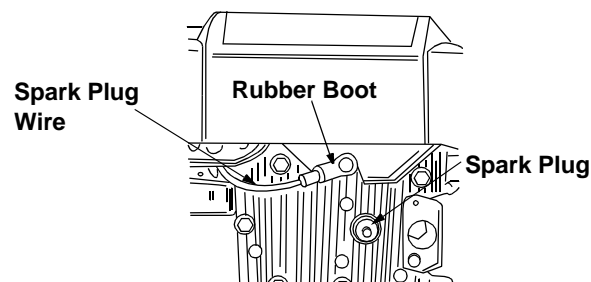

FIGURE 2

Assembling Handle

- Raise the lower handle in the direction shown in Figure 3 till it snaps into place.

Note: Make sure to route the cables inside the lower handle. Also do not crimp the cables while lifting the handle up.

For shipping purposes, the hairpin clip is placed in the outer hole of the weld pin on the lower handle.

- Remove the hairpin clip from the outer hole of the weld pin.
- Using a pair of pliers, insert the hairpin clip into the inner hole in the weld pin. Repeat on other side. See Figure 3 inset A.
- Raise the upper handle in the direction shown in Figure 3. Tighten the wing nuts which are already on the handle.
- Attach the cables to the lower handle with the two cable ties already on the lower handle. Pull tight the cable ties and cut off the extra. See inset B below.

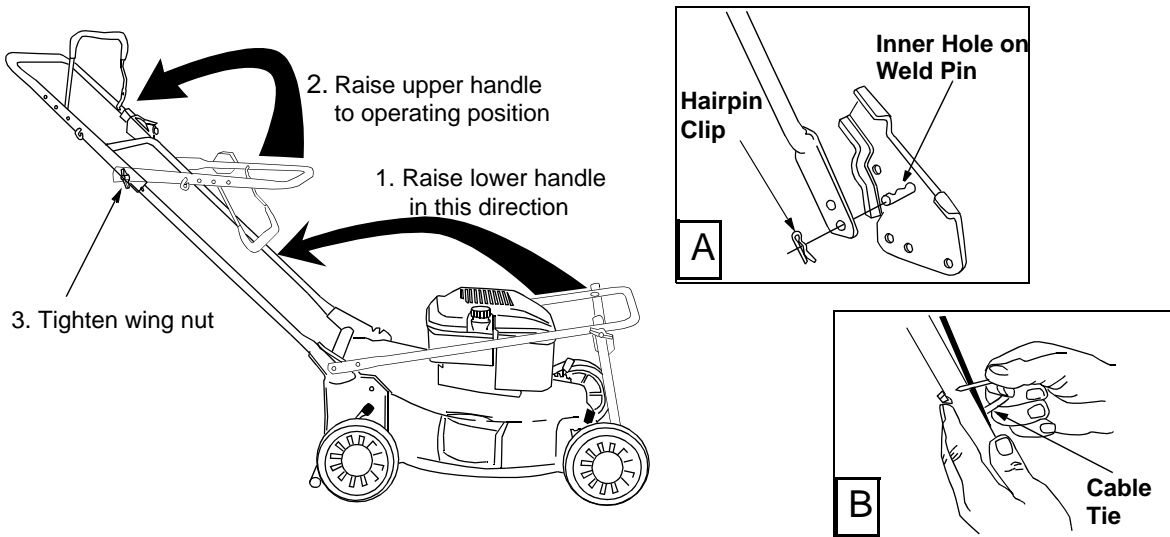

FIGURE 3

Attaching Starter Rope

The rope guide is already attached to the right side of the upper handle of your mower. See Figure 4.

- With the spark plug wire disconnected and grounded, hold the blade control handle against the upper handle, and pull the starter rope out of the engine.
- Slip the rope through the rope guide. Tighten the wing nut holding the rope guide to the upper handle. See Figure 4.

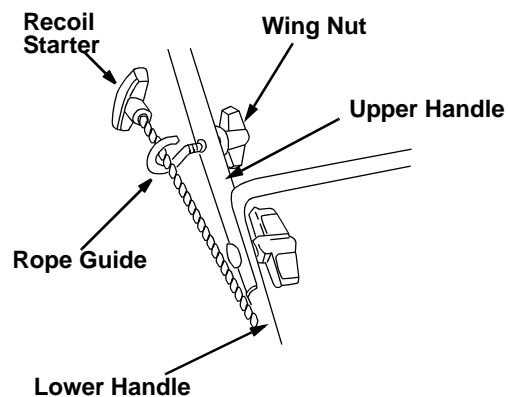

FIGURE 4

Attaching Side-Discharge Chute

Your lawn mower was shipped as a mulcher. Remove the mulching cover and attach the side-discharge chute to discharge grass clippings.

- Lift the hinged mulching plug. Slide the two hooks on the side discharge deflector under the hinge pin on the mulching plug assembly. See Figure 5. Lower the mulching plug.

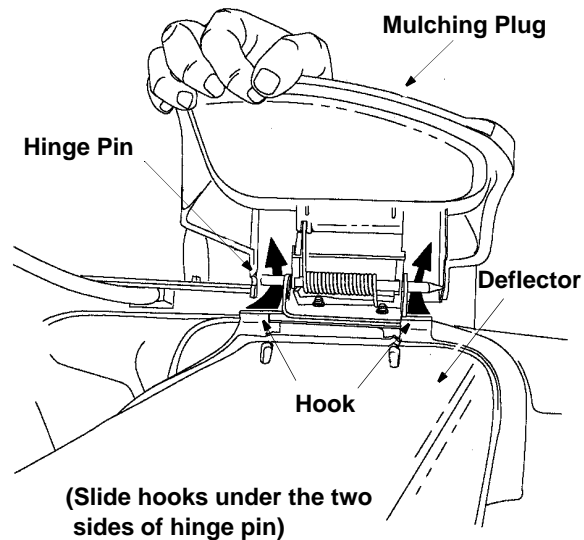

FIGURE 5

IMPORTANT: This unit is shipped WITHOUT GASOLINE or OIL. Be certain to service engine with gasoline and oil as instructed in the separate engine manual before operating your mower.

Attaching Rear Bagger

- To convert your mower from a mulcher to a rear bagger, remove side-discharge and lower the side mulching plug. For location of side mulching plug, see Figure 7.
- Lift the chute door on the mower. Remove the rear mulching plug. Place hooks, located on two sides of the grass catcher frame, over the chute door pivot rod on the back of the unit. See Figure 6. Release chute door.

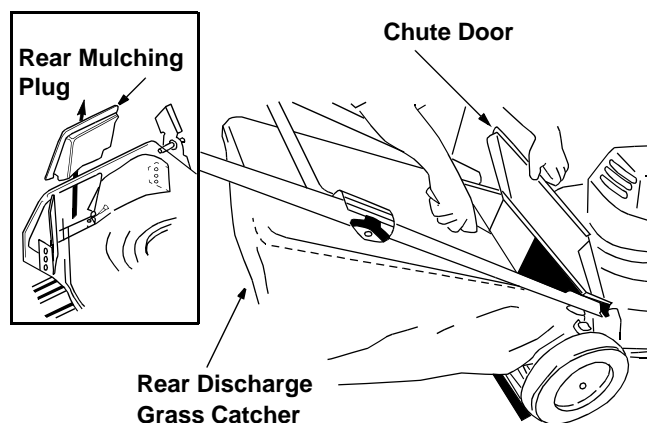

FIGURE 6

- To remove the grass catcher, lift the chute door on the mower. Lift the grass catcher up, and off of the pivot rod. Release the chute door.

SECTION 7: CONTROLS

Read this owner's manual and safety rules before operating your lawn mower. Compare the illustrations in Figure 7 with your lawn mower to familiarize yourself with the location of various controls and adjustments. Save this manual for future reference.

The operation of any lawn mower can result in foreign objects being thrown into the operator's eyes thus causing severe eye damage. **Always wear safety glasses** while operating the mower, or while performing any adjustments or repairs on it.

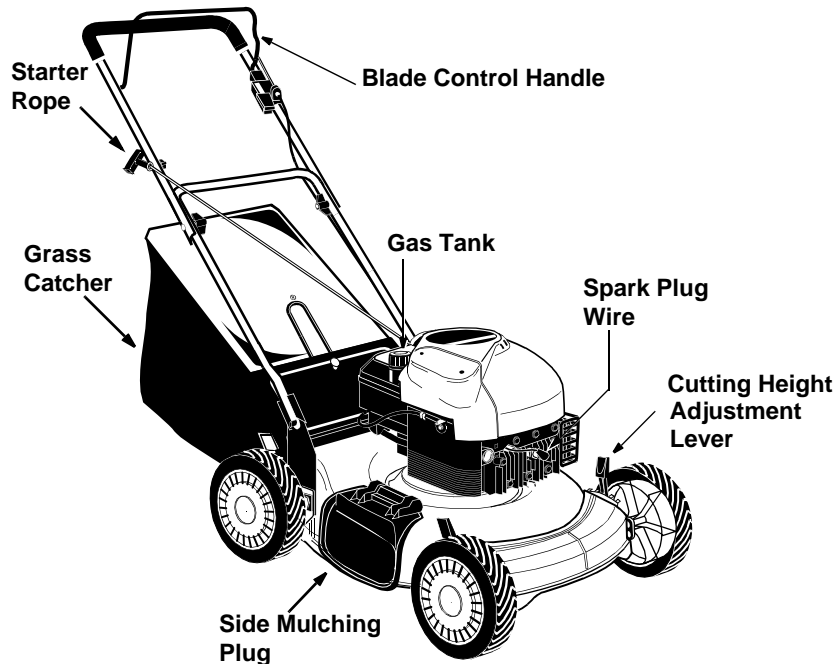

FIGURE 7

Recoil Starter

The recoil starter is attached to the handle. Stand behind the unit and pull the recoil starter to start the unit.

Primer

The primer is used to pump gas into the carburetor. Use it to start a cold engine, but do not use it to restart a warm engine after short shutdown. Refer to engine manual for illustration.

Blade Control Handle



WARNING: This control mechanism is a safety device. Never attempt to bypass its operations.

The blade control handle is located on the upper handle of the mower. The blade control handle must be depressed in order to operate the unit. Release the blade control handle to stop the engine and the blade.

Throttle Control

The throttle control is located on the engine and is used to regulate engine speed.



WARNING: The throttle control cannot be used to stop the engine. Do not adjust the throttle control with the engine running.

SECTION 8: OPERATION

Gas And Oil Fill-Up

Oil:

- Only use high quality detergent oil rated with API service classification SF, SG or SH. Use SAE30 oil; *do not use 10W40 oil.*
- Fill oil sump and check the oil level following steps below.
 - a. Position the mower on level ground and clean area around oil fill plug.
 - b. Remove oil fill plug and dipstick. Wipe dipstick clean, insert it into oil fill hole and tighten securely.
 - c. Remove dipstick and check oil level. If the oil is not upto FULL mark on the dipstick, pour recommended oil through the oil fill and check the level again. Install oil fill plug and dipstick, tighten securely.

NOTE: Although multi-viscosity oils (5W30, 10W30, etc.) improve starting in cold weather, these multiviscosity oils will result in increased oil consumption when used above 32°F. Check the oil level more frequently to avoid possible engine damage from running low on oil.

Gasoline



WARNING: Never fill fuel tank indoors, or when engine is running or hot. Do not smoke when filling up the fuel tank.

- Clean area around fuel cap. Remove cap. Use a funnel to prevent spillage.
- Pour approximately 1.5 quarts of fresh, regular grade, unleaded gasoline slowly to the fuel tank.

IMPORTANT: Never mix engine oil with gasoline.

- Fill tank to 1/2" below the bottom of the filler neck. Wipe any fuel spillage. **Do not fill** fuel tank completely. Provide space for fuel expansion.

Starting Engine



WARNING: Be sure no one other than the operator is standing near the lawn mower while starting engine or operating mower.

Never run engine indoors or in enclosed, poorly ventilated areas. Engine exhaust contains carbon monoxide, an odorless and deadly gas.

Keep hands, feet, hair and loose clothing away from any moving parts on engine and lawn mower.

- To prevent the unit from sliding, place your foot firmly against the tire.
- Attach spark plug wire to spark plug. Make certain the metal cap on the end of the spark plug wire is fastened securely over the metal tip on the spark plug.
- Move throttle control to FAST (rabbit) position.
- Push primer three times. Wait about two seconds between each push. In cold weather around 55° F or below, prime five times. Do not prime to restart a warm engine after a short shutdown.
- Grasp starter handle and pull rope out slowly until engine reaches the start of compression cycle (rope will pull slightly harder at this point). Let the rope rewind slowly. Pull rope with a rapid, continuous, full arm stroke. Keeping a firm grip on the starter handle, let the rope return to the starter slowly.

Stopping Engine

- Release blade control handle to stop the engine and the blade.
- Disconnect spark plug wire and move away from spark plug to prevent accidental starting. Do not use the throttle control to stop the engine.

Using Your Lawn Mower

Your mower is designed to operate as a rear bagger, mulching or a side-discharge unit.

- To convert from a mulcher to a side-discharge or a rear bagger unit, refer to instructions on page 8. **Do not** operate the mower without the mulching cover or the discharge chute properly installed and tightly secured.

- Be sure that the lawn is clear of stones, sticks, wire, or other objects which could damage lawn mower or engine. Such objects could be accidentally thrown by the mower in any direction and cause serious personal injury to the operator and others.
- *For best results, do not cut wet grass* because it tends to stick to the underside of the mower, preventing proper discharge of grass clippings, and could cause you to slip and fall. New grass, thick grass or wet grass may require a narrower cut. Blade speed should be adjusted to the condition of the lawn.
- The *best mowing pattern* is one that allows the clippings to discharge towards the uncut part of the lawn. This permits recutting of the clippings to further pulverize them. When cutting high weeds, discharge towards cut portion, then recut at right angles to first direction.
- For a *healthy lawn*, always cut off one-third or less of the total length of the grass. Lawn should be trimmed in fall as long as there is growth.
- This mower is designed to run at full throttle to give you the *best cut* and do the most effective job of bagging the cut grass.



WARNING: If you strike a foreign object, stop the engine. Remove spark plug wire from spark plug, thoroughly inspect the mower for any damage. Repair the damage before restarting and operating the mower. Extensive vibration of the mower during operation is an indication of damage. The unit should be promptly inspected and repaired.

Height Adjustment

Refer to height adjustments section of this manual on page 13 for instruction on how to adjust the cutting height and the handle height.

- For best results in mowing, keep the cutting height position high until it is determined which height is best for your lawn.

SECTION 9: MAINTENANCE



WARNING: Always stop the engine and disconnect the spark plug wire before performing any maintenance or adjustments.

Lubrication

For complete lubrication chart, see Figure 8.

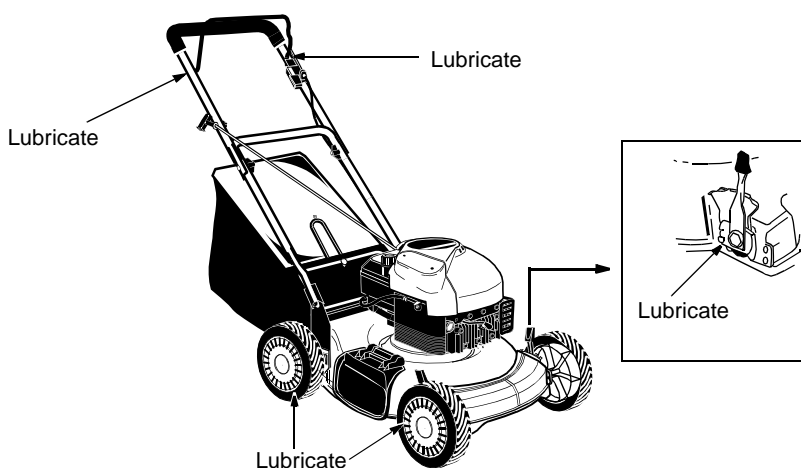

FIGURE 8

Wheels

- Lubricate the wheels and bearings, if so equipped, at least once a season with light oil or engine oil. Also, if the wheels are removed for any reason, lubricate the surface of the axle bolt and the inner surface of the wheel with light oil.

Pivot Points

- Lubricate the pivot points on the blade control handle, brake cable and the cutting height adjustment lever at least once a season with light oil. The blade control handle must operate freely in both directions. The cutting height adjustment lever should be able to move easily.

Engine

- Follow the engine manual instructions and recommended schedule for lubricating engine components.

Cleaning Mower

The underside of the mower deck should be cleaned after each use to prevent any build-up of grass clippings, leaves, dirt, or other debris. If this debris is allowed to accumulate, it will result in rust and corrosion.

- Disconnect spark plug wire.
- Drain the gasoline from the lawn mower, or place a piece of plastic under the gas cap.
- Tip the mower so that it rests on the housing. Keep the side with the air cleaner facing up. Hold the mower firmly.
- Scrape clean the underside of the deck with a suitable tool.
- Put the mower back on its wheels on the ground. If you had put plastic under the gas cap, make sure to remove it now.



WARNING: Never tip the mower more than 90 degrees and do not leave the mower tipped for any length of time. Oil can drain into the upper part of the engine causing a starting problem.

Engine Maintenance

- A list of key maintenance jobs required for good performance by the mower is given below. Follow the accompanying engine manual for detailed list and instructions.
- Change engine oil after the first two operating hours and every 25 operating hours thereafter. Check the oil level before starting the engine every time.
- Service foam filter in the air cleaner every 25 hours of use and replace the paper filter component every 100 hours. You may have to service the air filter more frequently if you are operating the mower under extremely dusty conditions.
- Clean the engine periodically. Remove dirt and debris with a cloth or brush. We do not recommend using a garden hose to clean mower unless the muffler, air filter and the carburetor are covered to keep water out. Water in engine can shorten engine life.
- Clean the spark plug and reset the gap to .030" at least once a season or every 50 hours of operation. Spark plug replacement is recommended at the start of each season. Refer to the engine manual for correct spark plug type.
- Inspect muffler periodically, and replace if necessary. Damaged mufflers or spark arresters can create a fire hazard. Make sure to avoid muffler and surrounding areas while the mower engine is hot because temperature of these areas of the engine may exceed 150° F.

SECTION 10: SERVICE & ADJUSTMENTS

Blade Care

Periodically inspect the blade adapter for cracks, especially if you strike a foreign object. Replace when necessary.



WARNING: When removing the cutting blade for sharpening or replacement, protect hands by using heavy gloves or a rag to grasp the cutting blade.

- Disconnect spark plug wire from spark plug.
- Turn mower on its side making sure that the air filter and the carburetor are up.

To Remove Blade

- Remove the bolt and blade bell support which hold the blade and adapter to the engine crankshaft. See Figure 9A.

- Remove the blade and adapter from the crankshaft.

To Replace Blade:

- Before reinstalling the blade and the blade adapter to the unit, lubricate the engine crankshaft and the inner surface of the blade adapter with light oil.
- Install the blade adapter on the crankshaft with the “star” away from the engine. See Figure 9A.

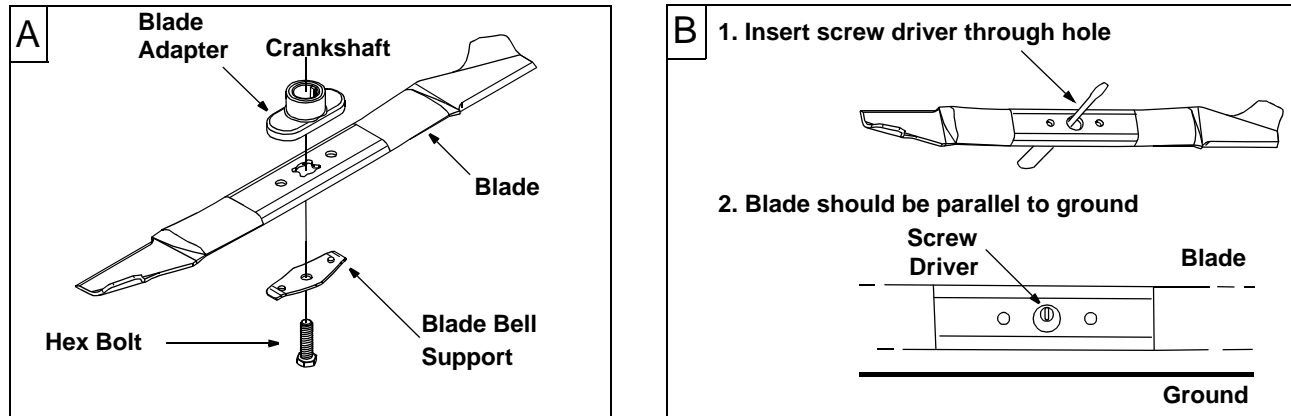

FIGURE 9

- Place the new blade with the side marked bottom (or with part number) facing away from the adapter.
- Place the bell support next. Make sure to align the tabs in the holes of the blade with the hole in the bell support.
- Insert the hex bolt through the blade assembly. Figure 9A shows the correct order of assembly.
- Use block of wood to hold blade again while you tighten the bolt clockwise. Follow the recommended torque for the bolt which is 450-600 in.-lbs.

IMPORTANT: The bolt, used to secure the blade to the engine, is specially heat-treated. **Do not substitute.** To order replacement bolt, refer to the Parts List section of this manual.



WARNING: To ensure safe operation of your unit, all nuts and bolts must be checked periodically for correct tightness.

To Sharpen Blade:

- The blade can be sharpened with a file or on a grinding wheel. Do not attempt to sharpen while operator is on the mower.
- Follow the original angle of grind as a guide. Make sure that each cutting edge receives an equal amount of grinding to prevent an unbalanced blade.

NOTE: An unbalanced blade will cause excessive vibration when rotating at high speeds, may cause damage to the mower and could break, causing personal injury.

- Test the blade by balancing it on a round shaft screwdriver or a blade balancer. See Figure 9B.
- If the blade is not balanced, remove metal from the heavy side until it balances evenly.

Adjusting Handle Height

Your mower is shipped with the handle in the higher height position. To lower the handle height, proceed as follows.

- Remove the starter rope from the rope guide.
- Remove the upper handle by removing the hand knobs and carriage bolts. Lay the upper handle out of the way, being careful not to bend or kink the cables.
- Remove the hairpin clips from the weld pins on the handle brackets. Refer to Figure 3 inset. Press out on the legs of the lower handle. Remove lower handle from the mower.

- Turn the lower handle around so the notch on the bottom of the lower handle is facing forward as shown in Figure 10. Reassemble, placing the bottom holes in the handle over the weld pins in the handle mounting bracket.

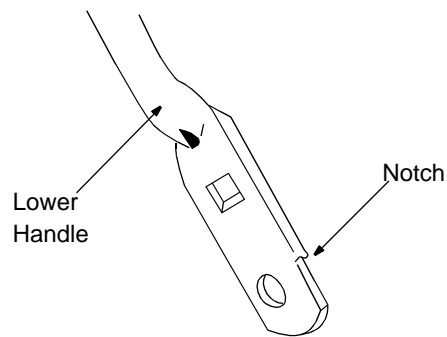

FIGURE 10

- Reassemble the upper handle to the lower handle.
- Place the hairpin clips in the inner holes in the weld pins and attach the starter rope as instructed in the Assembly section.

Adjusting Cutting Height

IMPORTANT: All wheels must be placed in the same relative position. For rough or uneven lawns, move the height adjustment lever to a higher position. This will help stop scalping of the grass.

An adjusting plate and thumb lever at each wheel position provides cutting height adjustment. Each adjusting plate has nine height positions. Height of cut will be changed when the thumb lever is moved from one hole to another.

- Simply depress the lever towards wheel and move lever assembly to desired position. See Figure 11.
- For rough or uneven lawns, move the height adjustment handles to higher cutting height position.

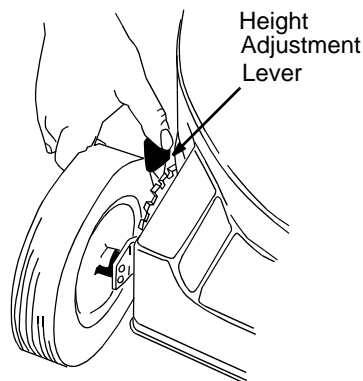

FIGURE 11

- Remove the screw shown in Figure 11. Remove the cable clamp from the cable.
- Push the throttle control lever on the handle all the way forward as far as it will go, then back it off one "click". Make certain the throttle control lever remains in this position.
- Push the control lever on the engine as far toward the rear of the engine as it will go.
- Secure the cable in this position with the cable clamp and screw.

SECTION 11: OFF-SEASON STORAGE

Prepare your lawn mower for storage at the end of the season or **if the unit will not be used for 30 days** or more. Store the mower in a **clean, dry area**.

Mower

- Clean underside of the mower following instructions in the Maintenance section of this manual.
- Inspect and replace/sharpen blade, if required. Refer to the Maintenance section of this manual for blade care instructions.
- Lubricate mower following the lubrication chart in Figure 8 on page 11.
- You can fold your mower's handle for convenient storage as shown in Figure 12.
 - a. Remove the starter rope from the rope guide.
 - b. Loosen the two hand knobs on the sides of the handle, and let the upper handle fold down to the rear.
 - c. Move the hairpin clips to the outer hole in the weld pins on the handle mounting brackets.
 - d. Spread the sides of the lower handle, and push it forward and down.

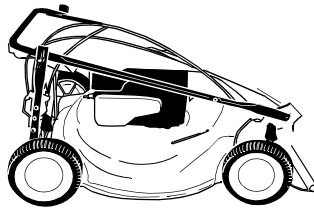

FIGURE 12

NOTE: When folding the handle for storage or transportation, be careful not to bend or kink the cables.

Engine

- Follow recommendations in the accompanying engine manual for off-season storage of the engine.
- Change oil if it has not been changed in the last three months. For instructions on how to change oil, refer to the engine manual.
- Clean engine and remove any grass clippings, dirt, or chaff from the exterior of the engine.
- Remove any dirt or debris from cooling fins, air intake screen, levers, and linkage.

Other

- Do not store gasoline from one season to another.
- Replace your gasoline can if it starts to rust. Rust and/or dirt in the gasoline will cause problems. Store unit in a clean, dry area. Do not store next to corrosive materials, such as fertilizer.

NOTE: If storing in an unventilated or metal storage shed, be certain to rustproof the equipment by coating with a light oil or silicone.

SECTION 12: TROUBLE-SHOOTING GUIDE

PROBLEM	POSSIBLE CAUSE	CORRECTIVE ACTION
Engine fails to start	<ol style="list-style-type: none"> 1. Blade control handle disengaged 2. Spark plug wire disconnected 3. Throttle control lever not in starting position 4. Fuel tank empty, or stale fuel 5. Blocked fuel line 6. Faulty spark plug 7. Engine flooded 	<ol style="list-style-type: none"> 1. Engage blade control handle. 2. Connect wire to spark plug. 3. Move throttle lever to starting position. 4. Fill tank with fresh, clean fuel. 5. Clean fuel line. 6. Clean, adjust gap or replace. 7. Crank engine with throttle in FAST position.
Engine runs erratic	<ol style="list-style-type: none"> 1. Spark plug wire loose 2. Blocked fuel line or stale fuel 3. Vent in gas cap plugged 4. Water or dirt in fuel system 5. Dirty air cleaner 	<ol style="list-style-type: none"> 1. Connect and tighten spark plug wire. 2. Clean fuel line, fill tank with clean, fresh gasoline. 3. Clear vent. 4. Drain fuel tank. Refill with fresh fuel. 5. Clean air cleaner. Refer to engine manual.
Engine overheats	<ol style="list-style-type: none"> 1. Engine oil level low 2. Air flow restricted 	<ol style="list-style-type: none"> 1. Fill crankcase with proper oil. 2. Clean lawn mower engine.
Occasional skip (hesitates) at high speed	<ol style="list-style-type: none"> 1. Spark plug gap too close 	<ol style="list-style-type: none"> 1. Adjust gap to .030 inches.
Idles poorly	<ol style="list-style-type: none"> 1. Spark plug fouled, faulty, or gap too wide 2. Dirty air cleaner 	<ol style="list-style-type: none"> 1. Reset gap to .030 inches or replace spark plug. 2. Clean air cleaner .
Excessive vibration	<ol style="list-style-type: none"> 1. Cutting blade loose or unbalanced 2. Bent cutting blade 3. Bent engine crankshaft 	<ol style="list-style-type: none"> 1. Tighten blade and adapter, balance blade. 2. Replace blade. 3. Contact your nearest White dealer
Mower will not mulch grass	<ol style="list-style-type: none"> 1. Engine speed too low 2. Wet grass 3. Excessively high grass 4. Dull blade 	<ol style="list-style-type: none"> 1. Move throttle lever to FAST position. 2. Wait until later to cut. 3. Mow once at a high cutting height, then mow again at desired height. Make a narrower cutting swath (1/2) width. Do not cut off more than 1/3 of the total length. 4. Sharpen or replace blade.
Uneven cut	<ol style="list-style-type: none"> 1. Wheels not in same height position 2. Dull blade 	<ol style="list-style-type: none"> 1. Place all four wheels in same relative height position. 2. Sharpen or replace blade.



For repairs beyond the minor adjustments listed above, please contact your nearest White Outdoor dealer.

SECTION 12: REPAIR PARTS

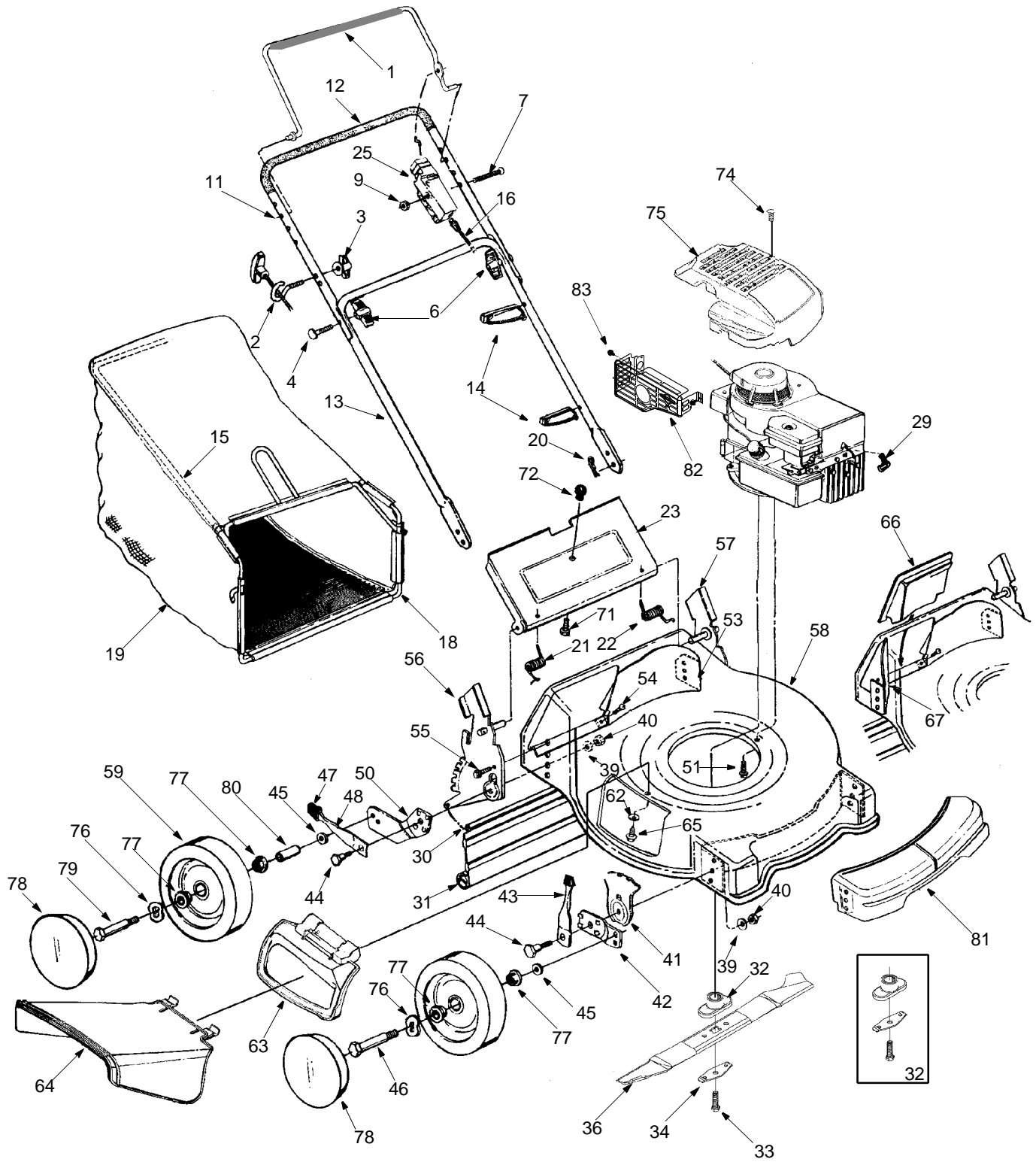

Ref. No.	Part No.	Code	Description	Ref. No.	Part No.	Code	Description
1	647-0004		Control Handle Assembly	49	14578		Height Adj. Assy—R.H.
2	710-1205		Rope Guide		14579		Height Adj. Assy—L.H.
3	720-0279		Handle Knob 1/4-20 Thd.				(not shown)
4	710-1174		Curved Hd. Bolt 5/16-18 x2"	50	14765		Pivot Bar
				51	782-5002		Front Baffle
6	720-0276		Hand Knob	52	710-0654A		Hex Lock Washer Hd.
7	710-1270		Oval C-Sunk Mach. Scr.				Scr. 3/8-16 x 1"
9	712-0324		Hex Lock Nut *	53	782-5003		Rear Baffle
11	749-0538C		Upper Handle	54	710-1017		Torx Mach. AB-Tap. Scr.
12	720-0295		Foam Grip				1/4 x .62"
13	749-0928		Lower Handle	55	710-1652	N	Hex Lock Washer Hd.
14	726-0240		Cable Tie				AB-Tap Scr.
15	764-0310		Rear Catcher Frame	56	682-0516		Handle Bracket
16	746-0553		Control Cable				Assembly—R.H.
18	764-0311		Front Catcher Frame	57	682-0515		Handle Bracket
19	764-0476A		Grass Bag 21" Soft Top	58	782-0047A-	N	Deck
20	714-0104		Internal Cotter Pin		0662		
21	732-0678		Door Spring—R.H.	59	734-1978	N	Wheel Assembly Comp.
22	732-0677		Door Spring—L.H.	62	736-0270		Bell Washer 1/4" I.D.
23	782-7000		Chute Door: Rear Discharge	63	682-7000		Hinged Mulching Plug
				64	731-1409		Chute Deflector: side discharge
25	746-0883		Control Housing				
27	—		Engine	65	710-0599		Hex Hd. Self-Tap. Scr.
29	735-0639		Spark Plug Boot				1/4-20 x .5
30	732-0700		Wire Rod	66	782-5007A	N	Mulching Baffle Plug
31	731-1236		Rear Flap	67	782-5004		Mulching Baffle—Rear
32	753-0588		Blade Adapter Kit	68	731-1405		Deflector (Optional)
33	710-1044		Hex Bolt 3/8-24 x 1.5"	69	711-0996		Rod (Optional)
34	736-0524A		Blade Bell Support	70	726-0201		Push Speed Nut (Optional)
36	742-0741		Mulching Blade 21"				
37	736-0169		Lock Washer 3/8 I.D. *	71	710-0192		Truss Scr. #10-24 x .38
38	712-0241		Hex Nut 3/8-24 Thd. *	72	720-0275		Knob: Chute Door
39	736-0356		Bell Washer *	74	710-1256		Hi-Lo Scr. #10 x 1.25
40	712-0798		Hex Nut 3/8-16 Thd. *	75	751B281451		XTL Gray Shroud
41	15261A		Height Adj. Plate	76	736-0504		Wave Washer
42	15262B		Pivot Bar	77	741-0180		Ball Bearings
43	14832		Spring Lever Assembly w/Knob	78	731-0981A		Hub Cap: Radial Spoke Gray
44	738-0507B		Shoulder Bolt	79	738-0213		Rear Axle Bolt
45	736-0105		Bell Washer .38" I.D. x .88"	80	750-0535		Spacer
				81	731-1950		Cover: Front Deck Gray
46	738-0102		Front Axle Bolt	82	751B224437	N	Muffler Guard
47	720-0190		Spring Lever Knob	83	710-1268	N	Hex Washer Head Screw
48	732-0417A		Spring Lever				

* For faster service, please obtain standard fasteners locally. If these are not available, please order at White Outdoor by the part number given here.

NOTE: Specifications subject to change without notice or obligation

MANUFACTURER'S LIMITED WARRANTY FOR:



For TWO YEARS from the date of retail purchase within the United States of America, its possessions and territories, White Outdoor Products Company will, at its option, repair or replace, for the original purchaser, free of charge, any part or parts found to be defective in material or workmanship. This warranty covers units which have been operated and maintained in accordance with the operating instructions furnished with the unit, and which have not been subject to misuse, abuse, neglect, accident, improper maintenance or alteration.

NORMAL WEAR PARTS or components thereof are subject to separate terms as noted below in the "No Fault Ninety Day Consumer Warranty" clause. Commercial use is subject to the terms listed above, and is covered for a period of 90 days from the date of purchase.

TWO YEAR CONSUMER WARRANTY ON NORMAL WEAR PARTS WITH NINETY DAY NO FAULT PROTECTION: All normal wear parts failures will be covered on this product for a period of 90 days regardless of cause. After 90 days, but within the two year period, normal wear parts failures will be covered if caused by defects in material or workmanship. Normal wear parts are defined as belts, blades, blade adapters, grass bags, rider deck wheels, seats, snow thrower skid shoes, shave plates and tires.

HOW TO OBTAIN SERVICE: Warranty service is available, with proof of purchase, through your local authorized service dealer. To locate the dealer in your area, please check the yellow pages or contact the Customer Service Department of White Outdoor Products Company, P O Box 361131, Cleveland, Ohio 44136-0019. Phone (330) 225-8883. The return of a complete unit will not be accepted by the factory unless prior written permission has been extended by the Service Department of White Outdoor Products Company.

TRANSPORTATION CHARGES: Transportation charges for the movement of any power equipment unit or attachment are the responsibility of the purchaser. Transportation charges for any parts submitted for replacement under this warranty must

be paid by the purchaser unless such return is requested by White Outdoor Products Company.

UNITS EXPORTED OUT OF THE UNITED STATES: White Outdoor Products Company does not extend any warranty for products sold or exported outside of the United States of America, its possessions and territories, except those sold through White Outdoor Products Company's authorized channels of export distribution.

OTHER WARRANTIES:

1. The engine or component parts thereof carry separate warranties from their manufacturers. Please refer to the applicable manufacturer's warranty on these items.
2. Batteries are covered by a 90-day replacement warranty.
3. Log splitter pumps, valves and cylinders or component parts thereof are covered by a one year warranty.
4. All other warranties, express or implied, including any implied warranty of merchantability or fitness for a particular purpose, are hereby expressly disclaimed in their entirety.
5. The provisions as set forth in this warranty provide the sole and exclusive remedy of White Outdoor Products Company's obligations arising from the sales of its products. White Outdoor Products Company will not be liable for incidental or consequential loss or damage.

HOW STATE LAW RELATES TO THIS WARRANTY: This limited warranty gives you specific legal rights, and you may also have other rights which vary from state to state. Certain disclaimers are not allowed in some states and therefore they may not apply to you under all circumstances.

NOTE: This warranty does not cover set-up, routine maintenance items such as lubricants, filters, blade sharpening and tune-ups, or adjustments such as brake adjustments. Nor does this warranty cover normal deterioration of the exterior finish due to use or exposure.



WARNING: The engine exhaust from this product contains chemicals known to the State of California to cause cancer, birth defects or other reproductive harm.