

Color TV with built-in VCR
Owner's Manual

CCC133AT
CCC193AT



Read this manual first!

*Congratulations on purchasing this Philips product.
We've included everything you need to get started.*

*If you have any problems, Philips Representatives can
help you get the most from your new product by explaining:*

- Hookups,
- First Time Setup, and
- Feature Operation.

Do not attempt to return this product to the store.

**For fast help, call us first!
1-800-531-0039**

Thank you for making Philips a part of your home!

Let's make things better.



PHILIPS

Return your Warranty Registration card today to ensure you receive all the benefits you're entitled to.

Once your PHILIPS purchase is registered, you're eligible to receive all the privileges of owning a PHILIPS product. So complete and return the Warranty Registration Card enclosed with your purchase at once. And take advantage of these important benefits.

Warranty Verification

Registering your product within 10 days confirms your right to maximum protection under the terms and conditions of your PHILIPS warranty.

Owner Confirmation

Your completed Warranty Registration Card serves as verification of ownership in the event of product theft or loss.

Model Registration

Returning your Warranty Registration Card right away guarantees you'll receive all the information and special offers which you qualify for as the owner of your model.

PHILIPS

Congratulations on your purchase, and welcome to the "family!"

Dear PHILIPS product owner:

Thank you for your confidence in PHILIPS. You've selected one of the best-built, best-backed products available today. And we'll do everything in our power to keep you happy with your purchase for many years to come.

As a member of the PHILIPS "family," you're entitled to protection by one of the most comprehensive warranties and outstanding service networks in the industry.

What's more, your purchase guarantees you'll receive all the information and special offers for which you qualify, plus easy access to accessories from our convenient home shopping network.

And most importantly you can count on our uncompromising commitment to your total satisfaction.

All of this is our way of saying welcome-and thanks for investing in a PHILIPS product.

Sincerely,



Robert Minkhorst
President and Chief Executive Officer

P.S. Remember, to get the most from your PHILIPS product, you must return your Warranty Registration Card within 10 days. So please mail it to us right now!



Know these safety symbols



⚡ This "bolt of lightning" indicates uninsulated material within your unit may cause an electrical shock. For the safety of everyone in your household, please do not remove product covering.

⚠ The "exclamation point" calls attention to features for which you should read the enclosed literature closely to prevent operating and maintenance problems.

WARNING: TO PREVENT FIRE OR SHOCK HAZARD, DO NOT EXPOSE THIS EQUIPMENT TO RAIN OR MOISTURE.

CAUTION: To prevent electric shock, match wide blade of plug to wide slot, fully insert.

ATTENTION: Pour éviter les choc électriques, introduire la lame la plus large de la fiche dans la borne correspondante de la prise et pousser jusqu'au fond.

For Customer Use

Enter below the Serial No. which is located on the rear of the cabinet. Retain this information for future reference.

Model No. _____
Serial No. _____



PHILIPS

Visit our World Wide Web Site at <http://www.philips.com>

Welcome to your TV/VCR owner's manual.

This manual describes two models: CCC133 and CCC193. The models may look different, but they operate exactly the same. The CCC133 is illustrated in this manual. The features described in this manual apply to both models unless otherwise specified.

Features

- A-B Repeat Play
- Automatic Channel Setup
- Automatic Head Cleaner
- Automatic Tracking Adjustment
- Blue Background
- Closed Caption
- Daylight-Savings Time
- English or Spanish displays
- Front Panel menu access
- FM Radio
- High Quality (HQ) System
- 19 micron head - provides a better picture when you view SLP tapes
- One-Touch Recording
- Real-Time Counter
- Remote Control
- Repeat Play
- ShowGuard™ - Indefinite Timer Recording memory
- Sleep Timer
- SmartClock™
- SmartLock™
- Special Effects: Forward and Reverse Searching; Still; Slow; Frame Advance
- S-VHS Quasi Play Back (SQPB)
- Timer Recording
- Wake Up Timer

Safety Precautions

Warning: To prevent fire or shock hazard, do not expose this equipment to rain or moisture.

Federal Communications Commission (FCC) Warning: Any unauthorized changes or modifications to this equipment void the user's authority to operate it.

This equipment has been tested and found to comply with the limits for a Class B digital device, pursuant to Part 15 of the FCC Rules. These limits are designed to provide reasonable protection against harmful interference in a residential installation. This equipment generates, uses, and can radiate radio frequency energy and, if not installed and used in accordance with the instructions, may cause harmful interference to radio communications.

However, there is no guarantee that interference will not occur in a particular installation. If this equipment does cause harmful interference to radio or television reception, which can be determined by turning the equipment off and on, the user is encouraged to try to correct the interference by one or more of the following measures:

1. Reorient or relocate the receiving antenna.
2. Increase the separation between the equipment and receiver.
3. Connect the equipment into an outlet on a circuit different from that to which the receiver is connected.
4. Consult the dealer or an experienced radio/TV technician for help.

Philips Consumer Electronics recommends you use only video cassette tapes that have the **VHS** mark. Other tapes may cause poor picture quality and excessive deposits on the video heads that the warranty may not cover if damage occurs.

This TV/VCR has a High Quality (HQ) system and is compatible with existing Video Home System (VHS) equipment.

Note to the Cable TV System Installer: This reminder calls the Cable TV system installer's attention to Article 820-40 of the National Electrical Code, which provides guidelines for proper grounding – in particular, specifying that the cable ground shall be connected to the grounding system of the building, as close to the point of cable entry as possible.

Declaration of Conformity

Model Numbers: CCC133AT, CCC193AT
Trade Name: Philips
Responsible Party: Philips Consumer Electronics
P.O. Box 14810
Knoxville, TN 37914-1810
(865) 521-4316



As an ENERGY STAR® Partner, Philips Consumer Electronics has determined that this product meets the ENERGY STAR® guidelines for energy efficiency. ENERGY STAR® is a U.S. registered mark. Using products with the ENERGY STAR® label can save energy. Saving energy reduces air pollution and lowers utility bills.

SmartClock™, SmartLock™, and ShowGuard™ are trademarks of Philips Consumer Electronics. Copyright 2001 Philips Consumer Electronics. All rights reserved.

4 Table of Contents

Setting Up Your TV/VCR

Introduction	3
Table of Contents	4
Before Using the TV/VCR	5
Hooking Up the TV/VCR	6-7
Turning On the TV/VCR	8
Language Selection	9
Automatic Channel Setup	10-11
Setting the Clock	12-17
Daylight-Savings Time	18
Time Zone	19

Description of Controls

Front Panel	20
Rear Panel	21
Remote Control Buttons	22-23
Adjusting the Picture Controls	24-25
On-Screen Status Displays	26
Reminder	27

Basic Operations

Playing	28
Recording	29

Recording Options

One-Touch Recording	30
Rerecording (Tape Duplication)	31
Timer Recording	32-35
Defeat Recording	36

Playing Options

Repeat Play	37
A-B Repeat Play	38-39
Real-Time Counter Memory	40
Playback Options	41

Additional Features

SmartLock	42-45
Blue Background	46
Sleep Timer	47
Wake Up Timer	48
Volume Bar	49
Closed Caption	50-51
FM Radio	52
Automatic Operation Features	53

Information You May Need

Helpful Hints	54-55
Glossary	56
Specifications	57
Limited Warranty	58
Index	59
Accessories	60

Before Using the TV/VCR 5

Putting Batteries in the Remote Control

1

Remove the battery compartment lid on the bottom of the remote control by pressing the tab, then lifting the lid.

2

Place two AA batteries inside the battery compartment with their + and - ends aligned as indicated.

3

Replace the battery compartment lid.

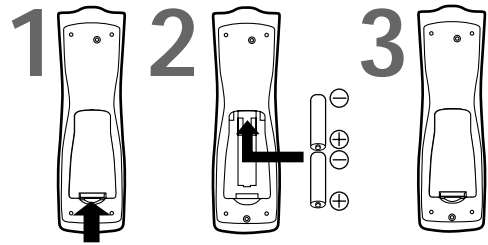

Battery Safety

- Battery Usage CAUTION - To prevent battery leakage that may result in bodily injury or damage to the unit: Install ALL batteries correctly, with the + and - markings on the battery aligned as indicated on the unit; Do not mix batteries, for example, old with new or carbon with alkaline; and Remove batteries when the unit will not be used for a long time.

Recording Prevention

Video cassette tapes have record tabs to ensure you do not erase recordings accidentally.

1

To prevent accidental recording, break off the tab with a screwdriver.

2

To record again, cover the hole with cellophane tape.

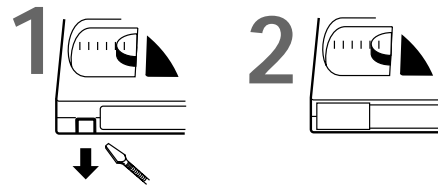

Using the Remote Control

- Point the remote control at the TV/VCR's remote sensor.
- Do not put objects between the remote control and the TV/VCR.

TV/VCR Maintenance

- In this TV/VCR, use only tapes with the **VHS** mark.
- Remove any light adhesive stick-on notes from the video cassette tape before putting the tape in the TV/VCR. Removable labels can jam the TV/VCR.
- The TV/VCR requires periodic maintenance to maintain its excellent performance. This TV/VCR has an automatic head cleaning system. However, the video heads will eventually require cleaning or replacement. Only an authorized service center should perform this service.

Helpful Hints

- Before doing anything else, record the TV/VCR's model and serial numbers in the spaces provided on page two. These numbers will help us assist you if you ever call for help.
- Your new product, its packaging, and this manual contain materials that can be recycled and reused. Specialized companies can recycle your product to increase the amount of reusable materials and to minimize the amount that needs to be properly disposed. Your product uses batteries that should not be thrown away when depleted but should be disposed of as small chemical waste. Please find out about the local regulations on disposal of your old product, batteries, manual, and packaging when you replace existing equipment.

6 Hooking Up the TV/VCR

1

Hook up your TV/VCR using one of the connections shown.

A.

Hooking Up Your TV/VCR With a Cable Signal or Outdoor Antenna

Connect a Cable signal or an antenna to the ANT(enna) Jack.

CCC133

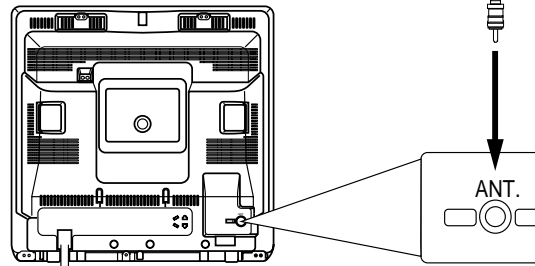

B.

Hooking Up Your TV/VCR With a Cable Box

To view any channel, set the TV/VCR to the Cable Box output channel (channel 03 or 04). Then, select channels at the Cable Box.

Connect the Cable signal to the IN Jack on the Cable Box.

Connect an RF coaxial cable (75-ohm, not supplied) to the OUT Jack on the Cable Box and to the ANT(enna) Jack on the TV/VCR.

CCC133

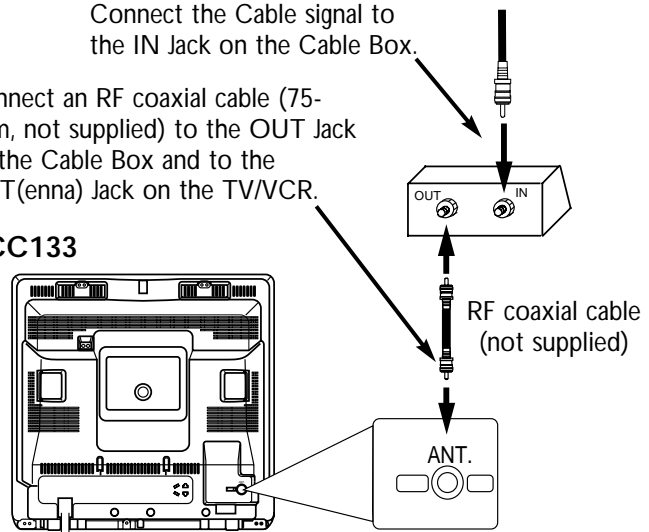

C.

Hooking Up Your TV/VCR With an Indoor Antenna

To install a rod antenna (not supplied), push the stem of the antenna into the antenna hole on the top of the TV/VCR. Connect the antenna wire to the ANT(enna) Jack on the back of the TV/VCR as shown. Extend the antenna and adjust its length, direction, and angle for the clearest picture.

Rod Antenna (not supplied)

CCC133

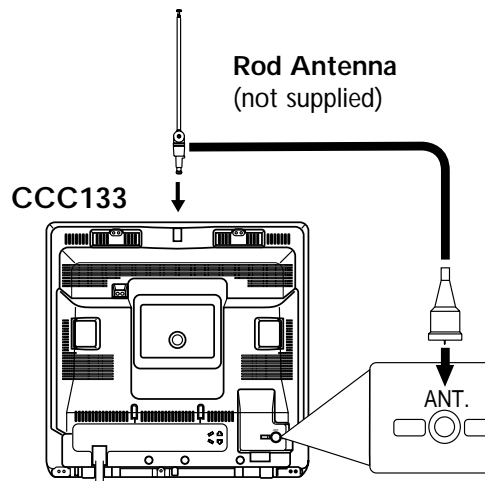

D.

Hooking Up Your TV/VCR to Another Video Source (VCR, DVD Player, Camcorder, etc.)

You may need this connection if you want to copy tapes or view tapes or discs that you are playing on the VCR, camcorder, or DVD Player. Select channel 00 (A/V IN) at the TV/VCR when viewing tapes or discs that are playing on the VCR, camcorder, DVD Player, etc. *Details are on page 31.*

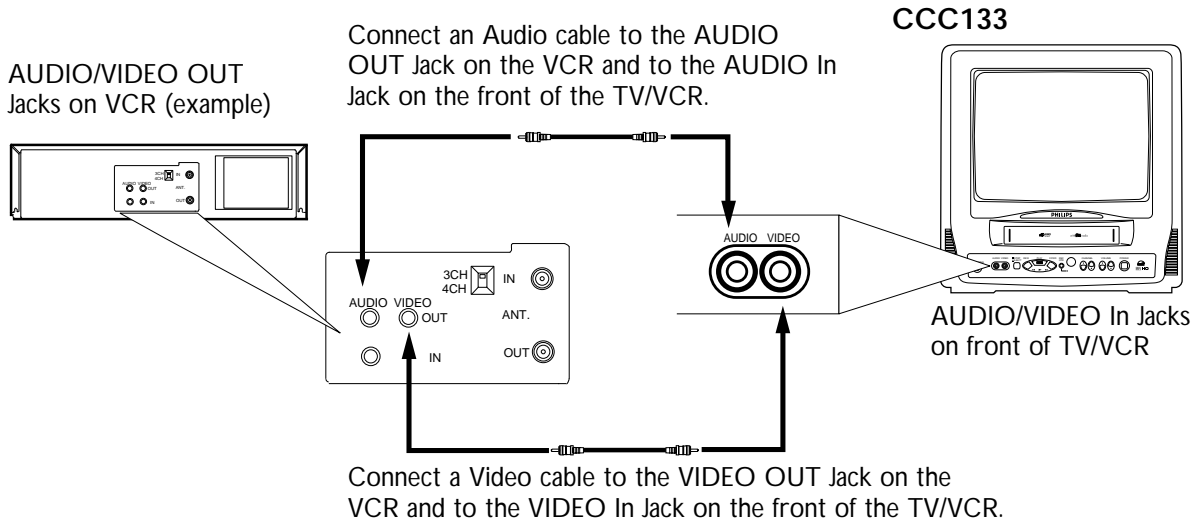

2

When all other connections are complete, plug in the TV/VCR's power cord.

3

Before you turn on the TV/VCR, go to page eight.

Helpful Hints

- Before connecting an antenna or cable signal to the ANT(enna) Jack, make sure the pin is not bent. If the pin is bent, straighten it as illustrated, then connect the antenna or cable signal to the ANT(enna) Jack.
- A rod antenna (not supplied) is available from Philips Service Solutions Group. The part number is 4835 303 37006. To order, call 1-800-851-8885. (This antenna will fit the CCC133 only.)
- Audio and video cables are not supplied.



8 Turning On the TV/VCR

Before you turn on the TV/VCR, make sure batteries are in the remote control and you have connected the TV/VCR correctly. The instructions on this page work only when you turn on the TV/VCR for the first time.

1

Press the **POWER** button. The TV/VCR will come on and the screen shown below will appear.

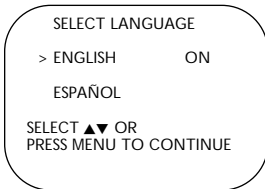

2

Press the **PLAY/▲** button or the **STOP/▼** button to select English or Spanish on-screen displays and menus.

3

Press the **MENU** button. The screen shown below will appear.

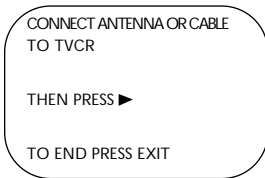

4

Press the **F.FWD/►** button to begin automatic channel setup. The TV/VCR will memorize all available channels. When channels are set, CHANNELS ARE SET will appear on the screen briefly. Then the TV/VCR will go to the lowest available channel. If you try to set up channels when there is no antenna or cable connected to the TV/VCR, programming will appear to take place, but eventually a NO TV SIGNALS ... message will appear on the screen. Connect an antenna or cable to the ANT(enna) jack on the TV/VCR, then press the F.FWD/► button again. You may need to follow the steps on page 10 instead.

5

Use the **CH(annel) ▲/▼** buttons or the **Number** buttons on the remote control to select a TV/VCR channel. Use the **VOL(ume) ▲/▼** buttons to adjust the sound.

When you scan channels with the CH(annel) ▲/▼ buttons, only the memorized channels will be available. Use the Number buttons to select non-memorized channels.

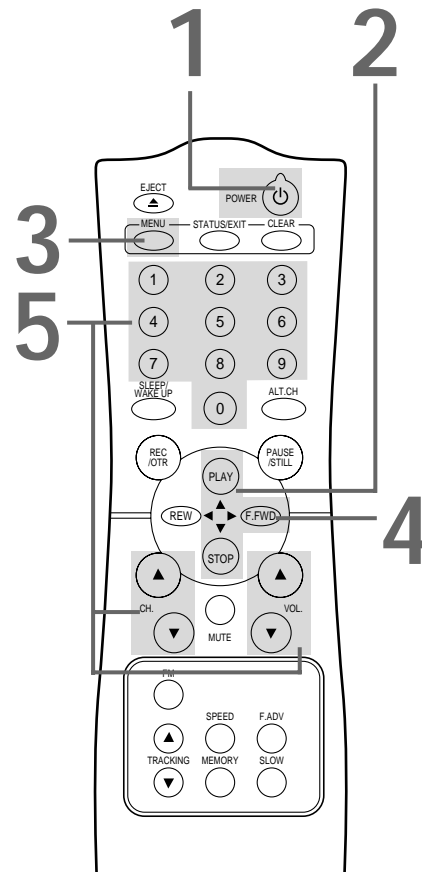

Helpful Hints

- If you do not see any on-screen displays when you turn on the TV/VCR, check your hookups, then try again. If you still do not see any on-screen displays, follow the steps on pages nine-10 to select a language and set up channels.
- To skip step 2, press the MENU button. All on-screen displays will be in English. To skip step 4, press the STATUS/EXIT button. Automatic Channel Setup will not occur, and CHANNELS NOT SET will appear on the screen briefly.
- You cannot set up channels if you are using a Cable Box.
- Line Input mode is channel 00. When you select channel 00, A/V IN will appear on the screen. Press the CH(annel) ▲/▼ buttons or the Number buttons to select another channel.

Language Selection 9

Follow the steps below to change the language of the on-screen displays and menus.

1

Press the **MENU** button.

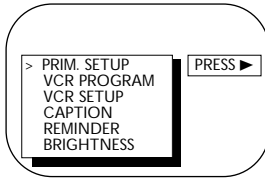

2

Press the **PLAY/▲** button or the **STOP/▼** button to select **PRIM. SETUP**. Then, press the **F.FWD/▶** button.

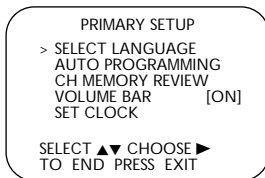

3

Press the **PLAY/▲** button or the **STOP/▼** button to choose **SELECT LANGUAGE**. Then, press the **F.FWD/▶** button.

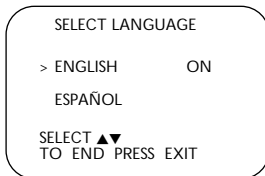

4

Press the **PLAY/▲** button or the **STOP/▼** button to select **ENGLISH** or **ESPAÑOL** (Spanish).

5

Press the **STATUS/EXIT** button.

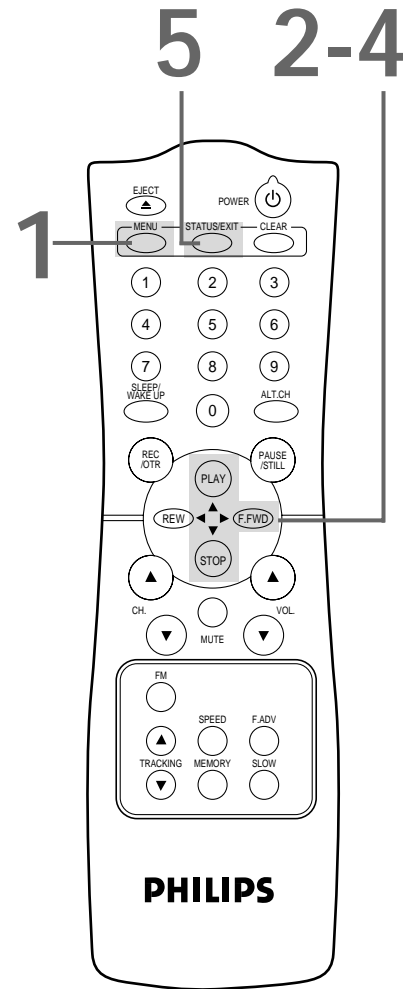

Helpful Hint

- If you accidentally select Spanish and need English on-screen displays and menus:
 - 1) Press the **MENU** button.
 - 2) Press the **PLAY/▲** button or the **STOP/▼** button to select **PREPARACION**, then press the **F.FWD/▶** button.
 - 3) Press the **PLAY/▲** button or the **STOP/▼** button to select **SELECCION IDIOMA**, then press the **F.FWD/▶** button.
 - 4) Press the **PLAY/▲** button or the **STOP/▼** button to select **ENGLISH**.
 - 5) Press the **STATUS/EXIT** button.

10 Automatic Channel Setup

Although the TV/VCR may automatically memorize the channels you receive when you turn it on for the first time, you may set up channels again by following the steps below.

1

Press the **MENU** button.

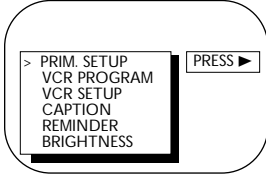

2

Press the **PLAY/▲** button or the **STOP/▼** button to select **PRIM. SETUP**, then press the **F.FWD/▶** button.

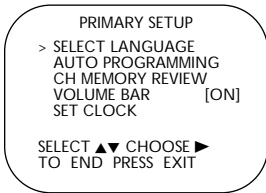

3

Press the **PLAY/▲** button or the **STOP/▼** button to select **AUTO PROGRAMMING**, then press the **F.FWD/▶** button. **AUTO CH PROGRAMMING ...** will appear on the screen. The TV/VCR distinguishes between TV channels and cable channels automatically, and the TV/VCR will memorize its available channels.

4

Wait for a few minutes. When setup is complete, **CHANNELS ARE SET** will appear on the screen. Then the programming of the lowest channel number will appear on the screen. Now, when you press the **CH(annel) ▲/▼** buttons, you will scan only through channels you receive. You can still select non-memorized channels using the **Number** buttons.

2-3

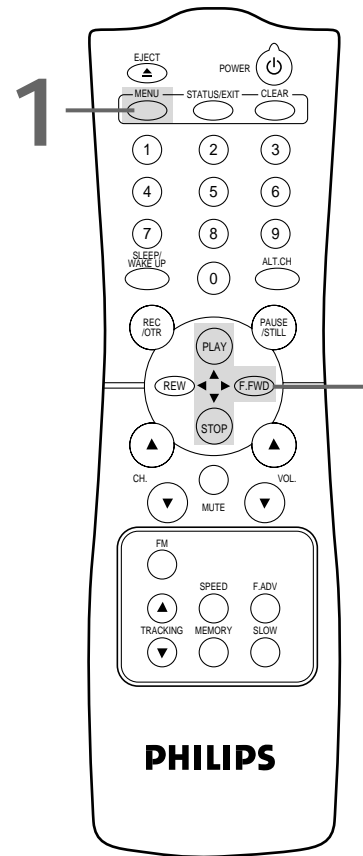

4

 Wait for the TV/VCR to set up channels.

Helpful Hints

- Line Input mode will always be channel 00. You cannot delete it.
- You can not select **AUTO PROGRAMMING** at step 3 if you are in Line Input mode.

Adding/Deleting Channels

If your channel lineup changes, you may want to add newly available channels or remove channels that are no longer available in your area. You can use the CH(annel) ▲/▼ buttons to scroll through only the available channels. To add or delete channels from the TV/VCR's memory, follow these steps.

1

Press the MENU button.

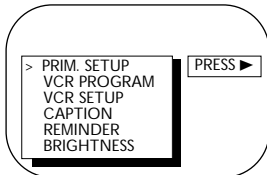

2

Press the PLAY/▲ button or the STOP/▼ button to select CHANNEL.

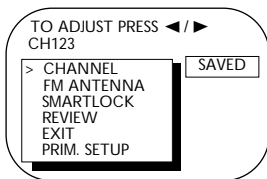

3

Press the CH(annel) ▲/▼ buttons or the Number buttons to select the channel you want to add or delete.

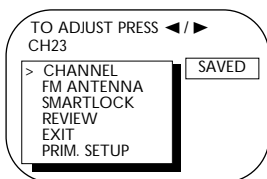

4

Press the F.FWD/▶ button or the REW(ind)/◀ button to select SAVED (to add that channel) or DELETED (to delete that channel).

Repeat steps 3-4 to add or delete other channels.

5

Press the STATUS/EXIT button.

Programming of the channel you added or deleted will appear.

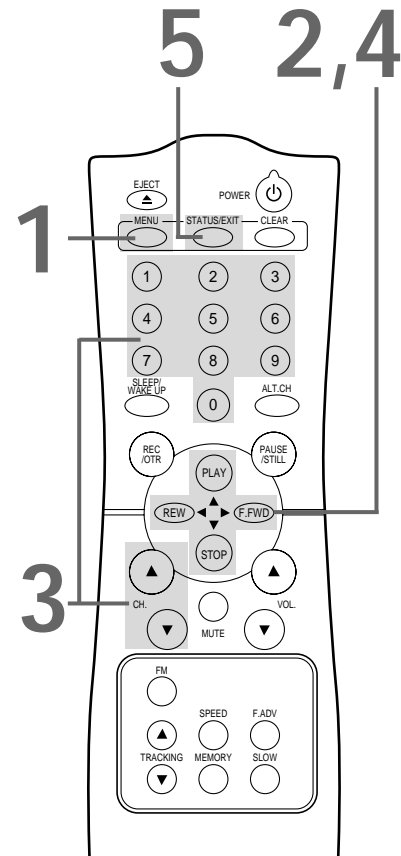

Helpful Hint

- To review the memorized channels, follow these steps.
 - 1) Press the MENU button.
 - 2) Press the PLAY/▲ button or the STOP/▼ button to select PRIM. SETUP. Press the F.FWD/▶ button.
 - 3) Press the PLAY/▲ button or the STOP/▼ button to select CH MEMORY REVIEW. Press the F.FWD/▶ button. A list of programmed channels will appear on the screen.
 - 4) If all the programmed channels don't fit on the screen, press the F.FWD/▶ button. If you do not press the F.FWD/▶ button within 10 seconds, the remaining channels will appear on the screen. (If there are no remaining channels, the previous menu will appear.) Or press the REW(ind)/◀ button to see the previous screen of channels.
 - 5) Press the STATUS/EXIT button once or twice.

12 Setting the Clock

There are three ways to set the clock: Manually, with Automatic PBS Channel Selection, or with Manual PBS Channel Selection. With manual clock setting, you tell the TV/VCR the current time. With Automatic or Manual PBS Channel Selection, the TV/VCR gets the time from your local PBS station.

If you use either Manual PBS Channel Selection or Automatic PBS Channel Selection, follow the steps on page 19 to have the TV/VCR maintain the clock according to your Time Zone. The channel that supplies the time might broadcast from a different time zone. So, select your Time Zone to ensure the clock is correct.

Cable Box users must set the clock manually.

To set the clock manually, follow the steps on pages 12-13. To set the clock using Automatic PBS Channel Selection, follow the steps on pages 14-15. To set the clock using Manual PBS Channel Selection, follow the steps on pages 16-17.

Before you begin, make sure:

- You have connected and turned on the TV/VCR. *Details are on pages six-eight.*
- Channels are set. *Details are on page 10.*
- You make each entry within 60 seconds of the previous entry.

Manual Clock Setting

1

Press the MENU button.

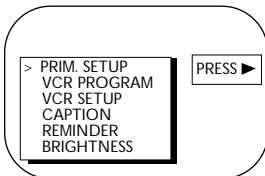

2

Press the PLAY/▲ button or the STOP/▼ button to select PRIM. SETUP. Then, press the F.FWD/▶ button.

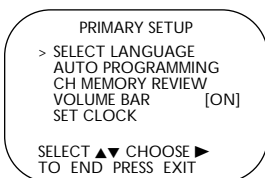

3

Press the PLAY/▲ button or the STOP/▼ button to select SET CLOCK. Then, press the F.FWD/▶ button.

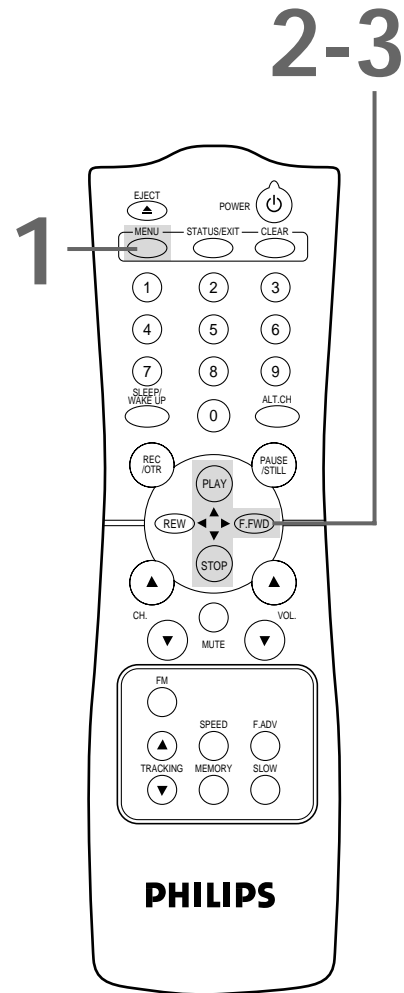
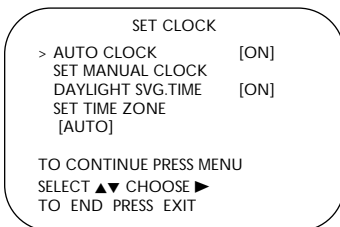

Helpful Hints

- Entries that do not match the TV/VCR's calendar will cause a question mark (?) to appear on the screen.
- To make corrections while you are setting the clock, press the CLEAR button until the space for the number you want to correct is flashing. Then enter the correct number.

4

Press the **PLAY/▲** button or the **STOP/▼** button to select **SET MANUAL CLOCK**, then press the **F.FWD/▶** button.

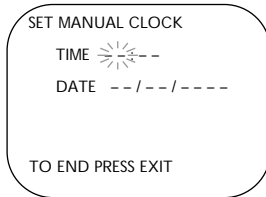

5

Press two **Number** buttons for the hour(s) and two **Number** buttons for the minute(s). Then press **1** for **AM** or **2** for **PM**. For example, for 9:30 PM, press 09, 30, 2.

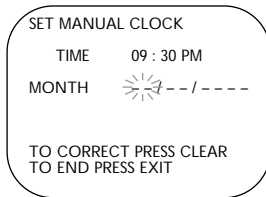

6

Press two **Number** buttons for the month, two **Number** buttons for the day, and two **Number** buttons for the year. For example, for July 1, 2001, press 07, 01, 01. The day of the week will appear automatically.

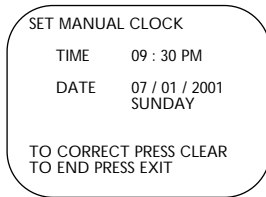

7

Press the **STATUS/EXIT** button.

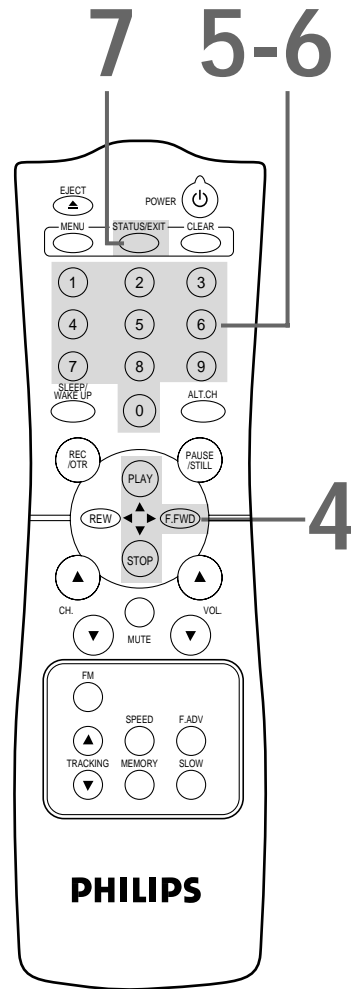

14 Setting the Clock (cont'd)

Automatic PBS Channel Selection

1

Press the MENU button.

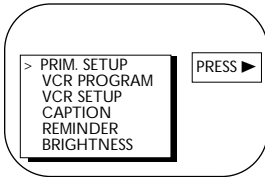

2

Press the PLAY/▲ button or the STOP/▼ button to select PRIM. SETUP. Then, press the F.FWD/► button.

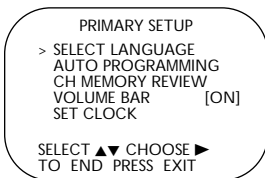

3

Press the PLAY/▲ button or the STOP/▼ button to select SET CLOCK. Then, press the F.FWD/► button.

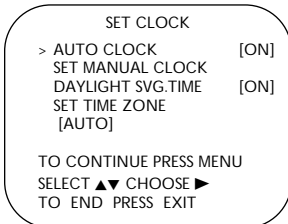

4

If ON appears beside AUTO CLOCK, press the MENU button.

If OFF appears beside AUTO CLOCK, press the PLAY/▲ button or the STOP/▼ button to select AUTO CLOCK, then press the F.FWD/► button so that ON appears to the right of AUTO CLOCK. Then, press the MENU button.

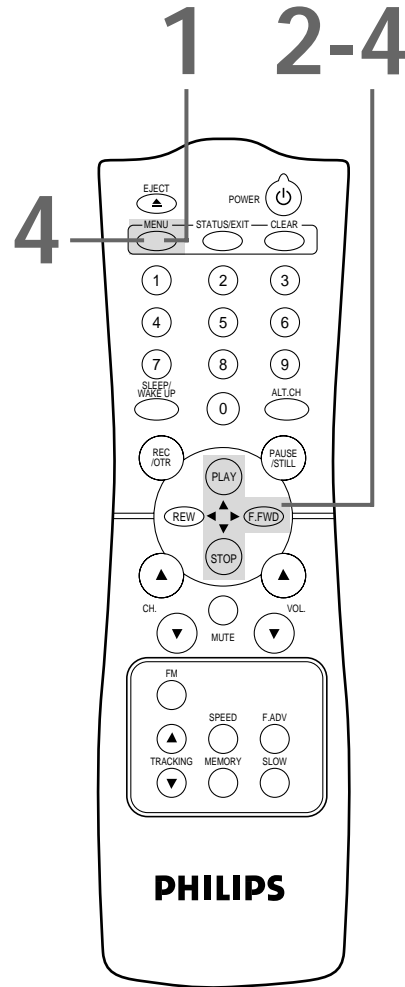
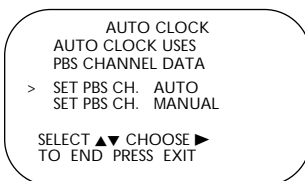

5

Press the **PLAY/▲** button or the **STOP/▼** button to select **SET PBS CH. AUTO**. Then, press the **F.FWD/▶** button.

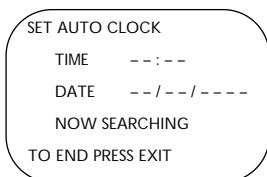

6

NOW SEARCHING flashes on the TV/VCR screen.

7

When the TV/VCR finds the PBS channel, the time will appear on the screen. Press the **STATUS/EXIT** button.

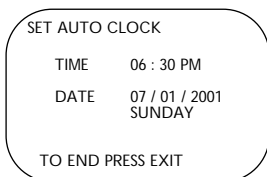

- If **CANNOT FIND CLOCK DATA** flashes on the TV/VCR screen, you will be prompted to turn off the TV/VCR. Turn off the TV/VCR. Leave it off for several minutes. When you turn on the TV/VCR again, the clock will be set.

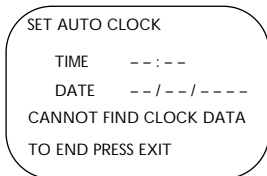

8

Follow the steps on page 19 to have the TV/VCR maintain the clock according to your time zone.

6

Wait for the TV/VCR to find the time.

7

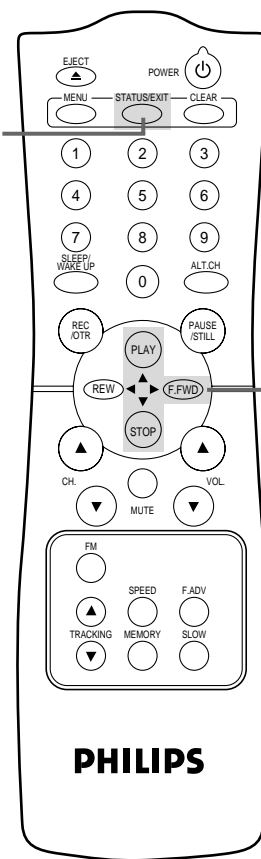

5

Helpful Hints

- To display the time on the TV/VCR screen, press the **STATUS/EXIT** button. Details are on page 26.
- You cannot use the **AUTO CLOCK** feature if you don't receive a PBS channel that carries a time signal in your area. Set the clock manually.

16 Setting the Clock (cont'd)

Manual PBS Channel Selection

1

Press the MENU button.

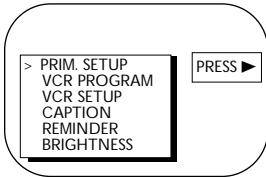

2

Press the PLAY/▲ button or the STOP/▼ button to select PRIM. SETUP. Then, press the F.FWD/► button.

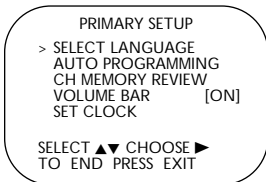

3

Press the PLAY/▲ button or the STOP/▼ button to select SET CLOCK. Then, press the F.FWD/► button.

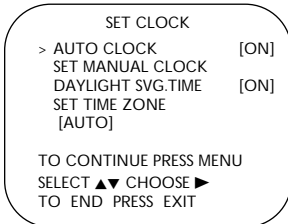

4

If ON appears beside AUTO CLOCK, press the MENU button.

If OFF appears beside AUTO CLOCK, press the PLAY/▲ button or the STOP/▼ button to select AUTO CLOCK, then press the F.FWD/► button so that ON appears to the right of AUTO CLOCK. Then, press the MENU button.

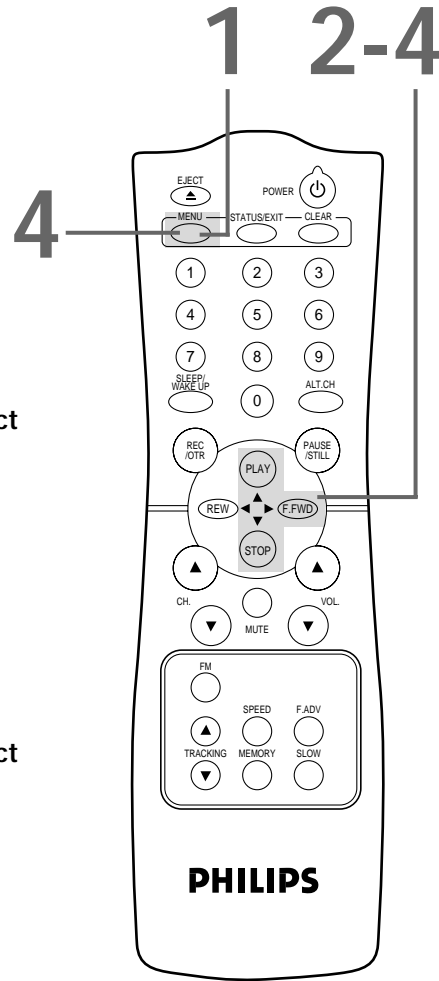
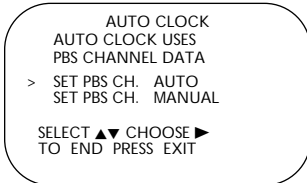

Setting the Clock (cont'd) 17

5

Press the **PLAY/▲** button or the **STOP/▼** button to select **SET PBS CH. MANUAL**. Then, press the **F.FWD/▶** button.

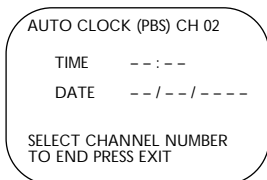

6

Use the Number buttons to select your PBS station.

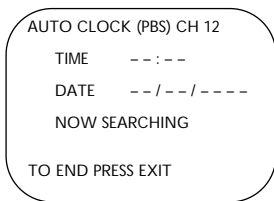

7

NOW SEARCHING flashes on the TV/VCR screen.

8

When the TV/VCR finds the clock data, the time will appear on the screen. Press the **STATUS/EXIT** button.

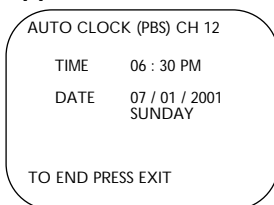

- If **CANNOT FIND CLOCK DATA** flashes on the TV/VCR screen and you know another PBS channel, press the **PLAY/▲** button or the **STOP/▼** button to choose **SELECT NEW PBS CH**. Then, press the **F.FWD/▶** button. Repeat step 6.
- If **CANNOT FIND CLOCK DATA** flashes on the TV/VCR screen and you do not know another channel, press the **PLAY/▲** button or the **STOP/▼** button to select **SET PBS CH. AUTO**. Then, press the **F.FWD/▶** button. The TV/VCR will search for the PBS channel automatically.
 - If the TV/VCR finds the PBS channel, the time will appear on the screen.
 - If the TV/VCR does not find the PBS channel, you will be prompted to turn off the TV/VCR. Leave it off for several minutes. When you turn on the TV/VCR again, the time will be set.

9

Follow the steps on page 19 to have the TV/VCR maintain the clock according to your time zone.

7

Wait for the TV/VCR to find the time.

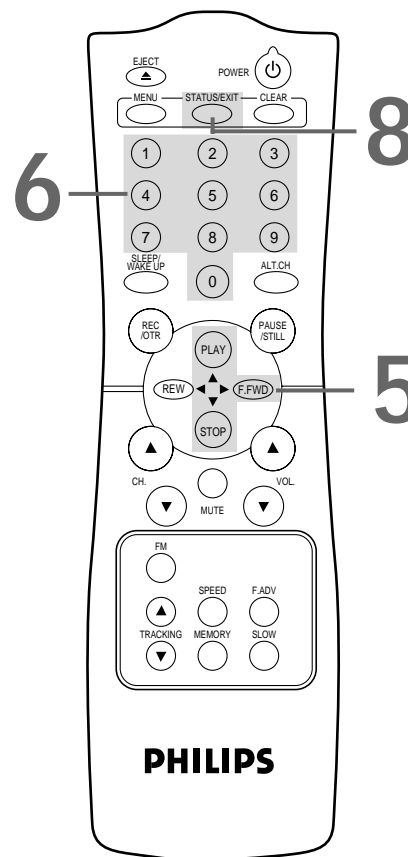

Helpful Hints

- If you have an Antenna hookup, you may select channels 2-69 at step 6. If you have a cable connection, you may select channels 1-125 at step 6. Details about available memo-rized channels are on page 11.
- To display the time on the TV/VCR screen, press the **STATUS/EXIT** button. Details are on page 26.

18 Daylight-Savings Time

When the Daylight-Savings Time feature is ON, the TV/VCR clock will automatically move forward one hour on the first Sunday in April and move back one hour on the last Sunday in October. To turn Daylight-Savings Time ON or OFF, follow the steps below.

1

Press the **MENU** button.

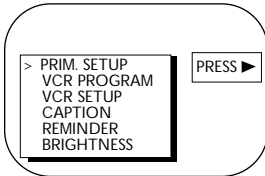

2

Press the **PLAY/▲** button or the **STOP/▼** button to select **PRIM. SETUP**. Then, press the **F.FWD/▶** button.

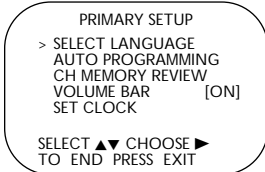

3

Press the **PLAY/▲** button or the **STOP/▼** button to select **SET CLOCK**. Then, press the **F.FWD/▶** button.

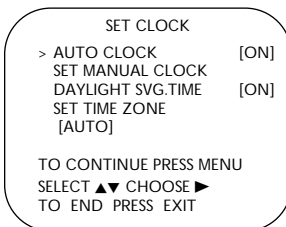

4

Press the **PLAY/▲** button or the **STOP/▼** button to select **DAYLIGHT SVG.TIME**. Then, press the **F.FWD/▶** button so that **ON** or **OFF** appears beside **DAYLIGHT SVG.TIME** (Daylight Savings Time).

5

Press the **STATUS/EXIT** button.

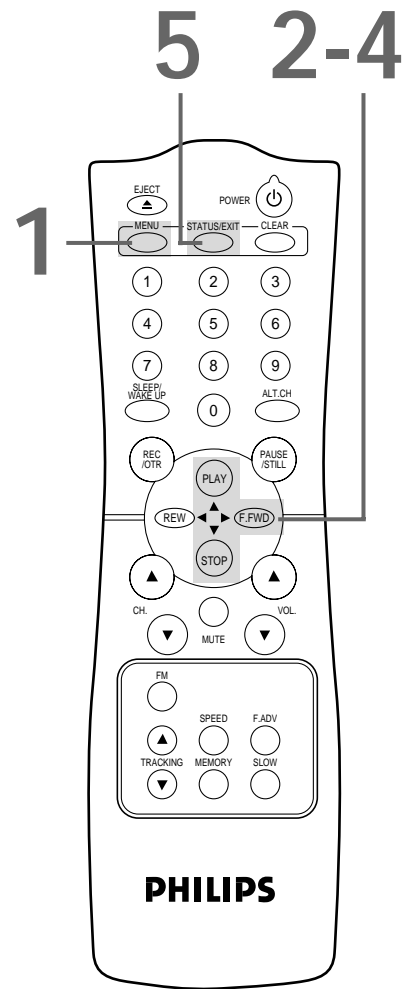

Time Zone 19

When you set the clock using AUTO CLOCK, specify your time zone.
The TV/VCR will maintain the clock according to your time zone.

1

Press the **MENU** button.

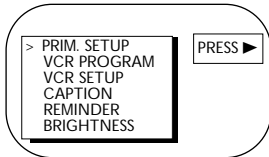

2

Press the **PLAY/▲** button or the **STOP/▼** button to select **PRIM. SETUP**. Then, press the **F.FWD/▶** button.

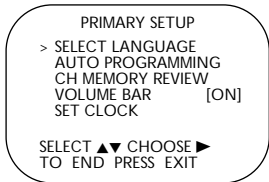

3

Press the **PLAY/▲** button or the **STOP/▼** button to select **SET CLOCK**. Then, press the **F.FWD/▶** button.

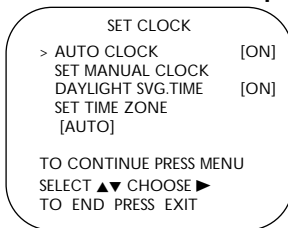

4

Press the **PLAY/▲** button or the **STOP/▼** button to select **SET TIME ZONE**. Then, press the **F.FWD/▶** button.

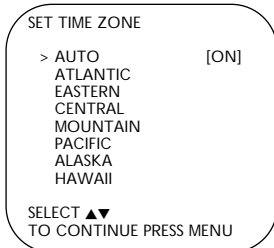

5

Press the **PLAY/▲** button or the **STOP/▼** button to select your time zone.

6

Press the **MENU** button, then press the **STATUS/EXIT** button.

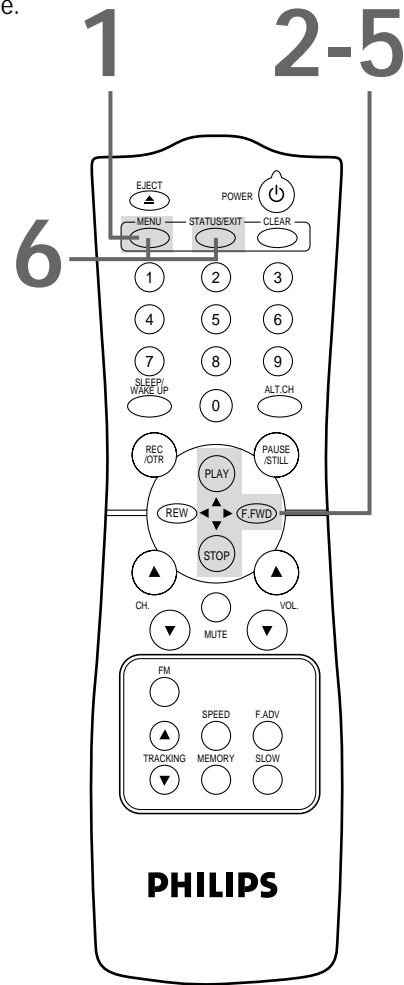

Helpful Hints

- If you select **AUTO** at step 5, the TV/VCR will set the clock according to the time zone data of the PBS station it finds.
- You cannot select **SET TIME ZONE** at step 4 if **AUTO CLOCK** is **OFF**.
- You may need to turn off the TV/VCR for several minutes to enable the TV/VCR clock to adjust to your time zone.

20 Front Panel

CCC133

Cassette Compartment

Insert a video cassette tape here.

Wireless Remote Sensor

Receives a signal from your remote control so you can operate the TV/VCR from a distance.

STOP/EJECT Button

Press once to stop the tape. When playback is stopped, press to eject the tape. Press to select an item in the menu.

VIDEO In Jack

Connect this jack to the video out jack of a VCR, camcorder, DVD Player, etc. *Details are on page 31.*

AUDIO In Jack

Connect this jack to the audio out jack of a VCR, camcorder, DVD Player, etc. *Details are on page 31.*

EARPHONE Jack

Connect earphones (not supplied) here for personal listening.

REW(ind) Button

When tape playback is stopped, press to rewind the tape at high speed. During playback, press to rewind the tape while the picture stays on the screen. Press to change a setting of a menu item (for example, to adjust the BRIGHTNESS) or to return to a previous menu.

PLAY Button

Press to play a tape. *Details are on page 28.* Press to release Search or Still mode and return to normal playback. *Details are on page 41.* Press to select an item in the menu.

F.FWD (Fast Forward) Button

When tape playback is stopped, press to fast forward the tape at high speed. During playback, press to fast forward the tape while the picture stays on the screen. Press to change a setting of a menu item (for example, to adjust the BRIGHTNESS) or to advance to the next menu.

REC(ord)/OTR Button

Press once to start a recording. *Details are on page 29.* Press repeatedly to start a One-Touch Recording (an immediate timed recording, 30 minutes to eight hours long) of the channel you are watching. *Details are on page 30.*

Record Light

This light appears during a recording. It flashes slowly when the TV/VCR power is off for a timer recording. It blinks rapidly when a recording is paused or when the power is off for a timer recording, but there is no tape in the TV/VCR. It will blink rapidly two minutes before a timer recording is set to begin if the TV/VCR power is on.

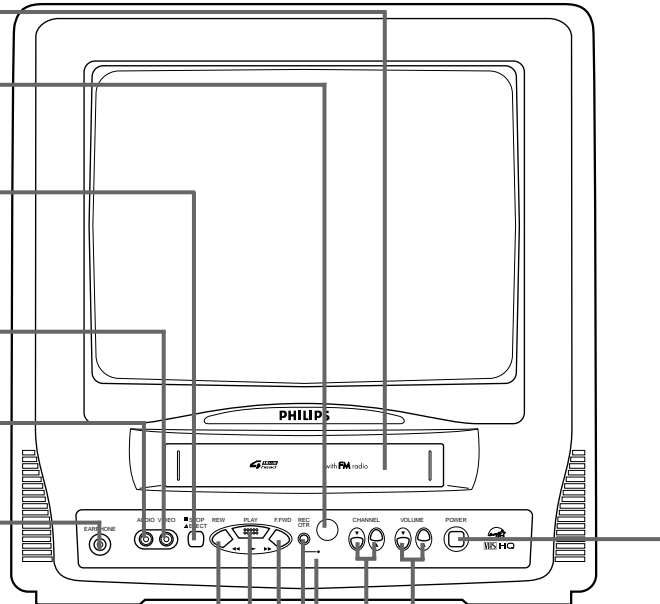

VOLUME ▲/▼ Buttons

Press to adjust the sound level. Press the CHANNEL ▲ button and the VOLUME ▼ button on the TV/VCR at the same time to display the main menu. Press again to remove the main menu.

CHANNEL ▲/▼ Buttons

Press to scan through the TV/VCR's memorized channels. During tape playback, press to adjust the tracking. *Details are on page 53.* Press the CHANNEL ▲ button and the VOLUME ▼ button on the TV/VCR at the same time to display the main menu. Press again to remove the main menu.

POWER Button

Press to turn the power on or off.

CCC133

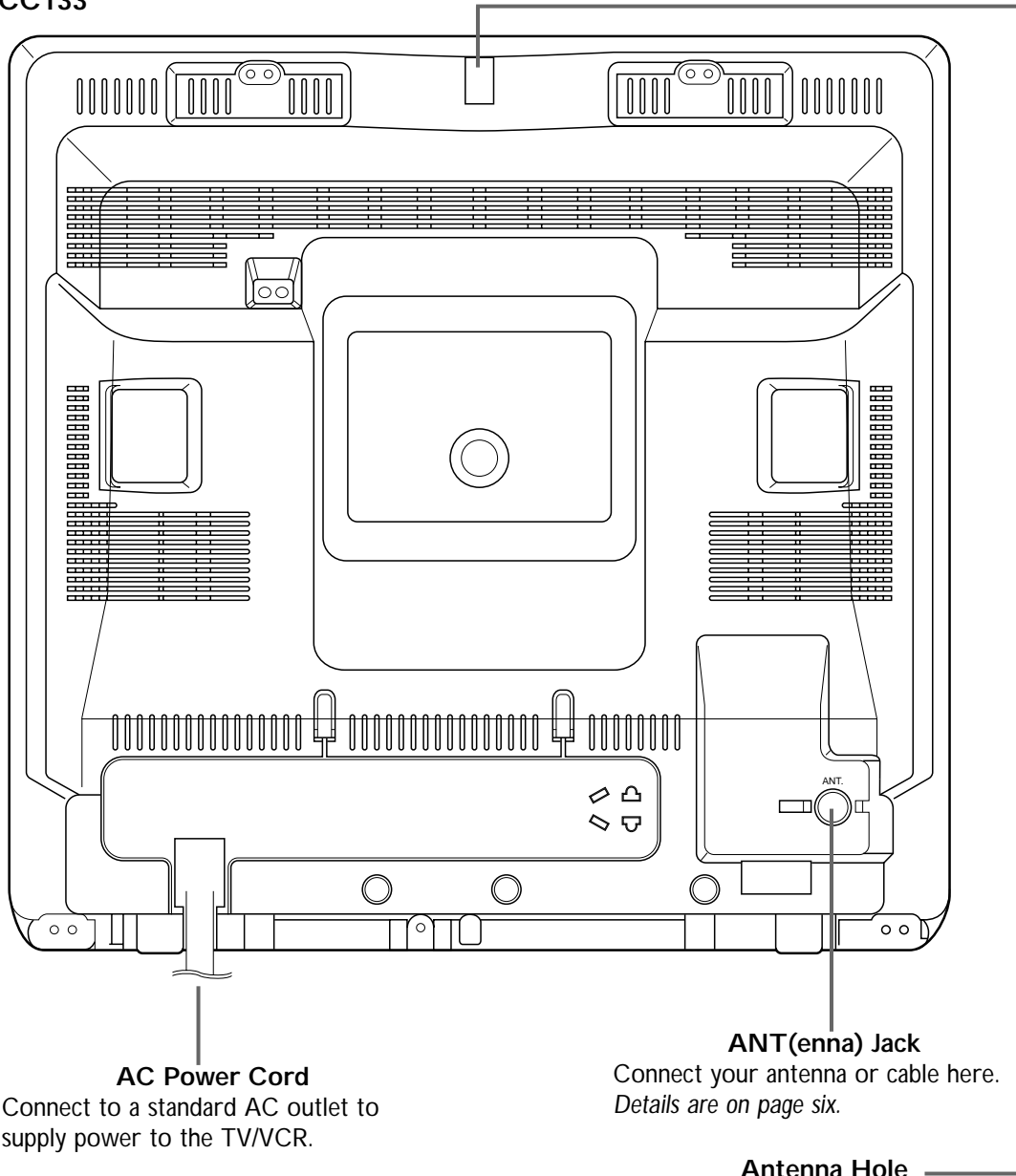

AC Power Cord

Connect to a standard AC outlet to supply power to the TV/VCR.

ANT(enna) Jack

Connect your antenna or cable here. Details are on page six.

Antenna Hole

Connect the stem of an indoor antenna here. Details are on page six.

22 Remote Control Buttons

CLEAR Button

Press to erase incorrect data when programming TV/VCR functions. Also, press to reset the real-time counter to 0:00:00.

Details are on page 40.

POWER Button

Press to turn on or off the TV/VCR.

EJECT Button

Press to eject the tape.

Number Buttons

Use to select channels and to program TV/VCR functions (such as setting the clock).

● **Cable Users**

Enter channel numbers as a two-digit number for the quickest results.

For example, to select channel 6, press 0,6. If you only press the Number 6 button, channel 6 will be selected after a brief delay. (There also may be a brief delay when you select channels 10, 11, and 12.) If you want to select channels 100 and above, enter channel numbers as a three-digit number. For example, to select channel 117, press 1, 1, 7.

● **Antenna Users**

Enter channel numbers as a two-digit number for the quickest results.

For example, to select channel 5, press 0,5. If you only press the Number 5 button, channel 5 will be selected after a brief delay. You may only select channels 2-69.

SLEEP/WAKE UP Button

Press to set the Sleep Timer. *Details are on page 47.* Press to set the Wake Up Timer. *Details are on page 48.*

PLAY/▲ Button

Press to play a tape. *Details are on page 28.* Press to release Search, Slow, or Still mode and return to normal playback. *Details are on page 41.* Press to select an item in the menu.

MUTE Button

Press to eliminate the TV/VCR's sound. Press again to return to the previous volume level.

SPEED Button

Press to select the recording speed (SP or SLP).

VOL(ume) ▲/▼ Buttons

Press to adjust the sound level. If you press the VOL(ume) ▲/▼ buttons when the sound is muted, the sound will be restored.

F.FWD/▶ Button

When tape playback is stopped, press to fast forward the tape at high speed. During tape playback, press to fast forward the tape while the picture stays on the screen. *Details are on page 41.*

Press to change the setting of a menu item or to go to the next menu.

ALT. CH (Alternate Channel) Button

Press to return to the TV channel you were viewing immediately before switching to your current channel.

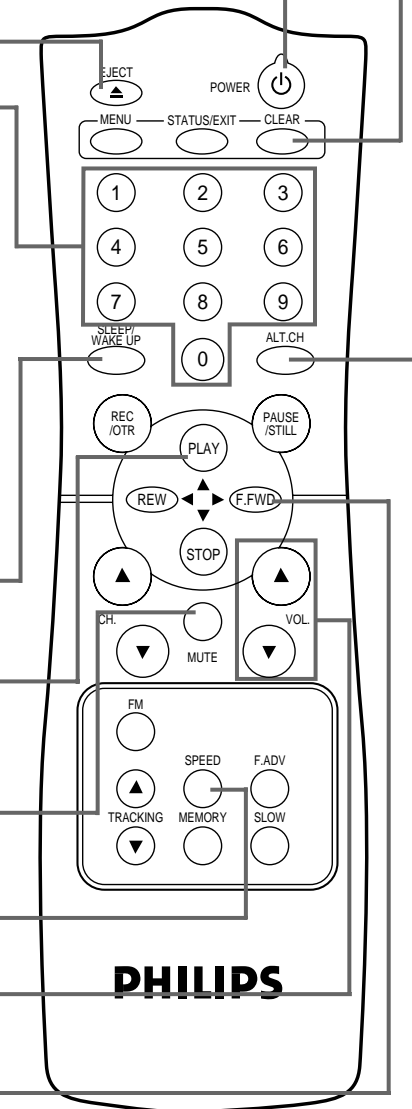

MENU Button

Press to display the main menu. You also may use the buttons on the front of the TV/VCR to access the main menu. *Details are on page 20.*

STATUS/EXIT Button

Press to access or remove the status display. *Details are on page 26.*
Press to remove the menu.

REC(ord)/OTR Button

Press once to start a recording. *Details are on page 29.* Or, press repeatedly to start a One-Touch Recording (an immediate timed recording, 30 minutes to eight hours long) of the channel you are watching. *Details are on page 30.*

REW(ind)/◀ Button

When tape playback is stopped, press to rewind the tape at high speed. During tape playback, press to rewind the tape while the picture stays on the screen. *Details are on page 41.*
Press to change a setting of a menu item or to return to a previous menu.

STOP/▼ Button

Press to stop the tape. Press to select an item in the menu.

CH(annel) ▲/▼ Buttons

Press to scan through the TV/VCR's available channels.

FM Button

Press to select FM radio mode. Press again to return to TV mode. *Details are on page 52.*

TRACKING ▲/▼ Buttons

Press during tape playback to adjust the tracking. *Details are on page 53.*

MEMORY Button

Press to memorize a tape position at which you set the real-time counter to 0:00:00. *Details are on page 40.* Or, press to memorize the start and end positions of a segment on a tape when setting up A-B Repeat Play. *Details are on pages 38-39.*

SLOW Button

During tape playback, press to view the picture in slow motion. *Details are on page 41.*

F(rame). ADV(ance) Button

Press when in Still mode to advance the picture one frame at a time. *Details are on page 41.*

PAUSE/STILL Button

During recording, press to temporarily stop the recording. Press again to resume recording. *Details are on page 29.* You cannot pause a One-Touch Recording.
During tape playback, press to freeze the picture (still). Press again to resume normal playback. *Details are on page 41.*

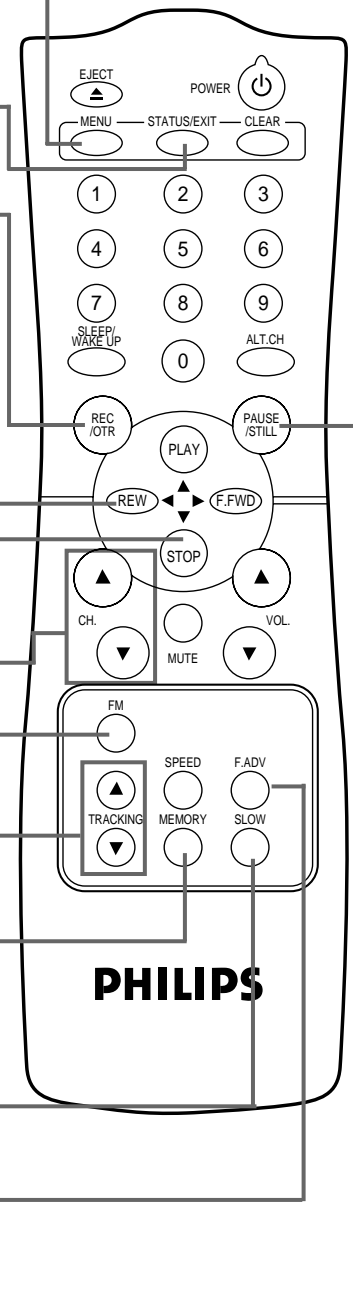

24 Adjusting the Picture Controls

Follow these steps to adjust the TV/VCR's brightness, picture, color, tint, and sharpness.

1

Press the MENU button.

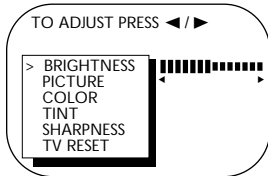

2

Press the PLAY/▲ button or the STOP/▼ button to select the desired control (BRIGHTNESS, for example).

3

Press the REW(ind)/◀ button or the F.FWD/▶ button to adjust the picture control. (Refer to the chart on page 25.)

4

When you finish, press the STATUS/EXIT button.

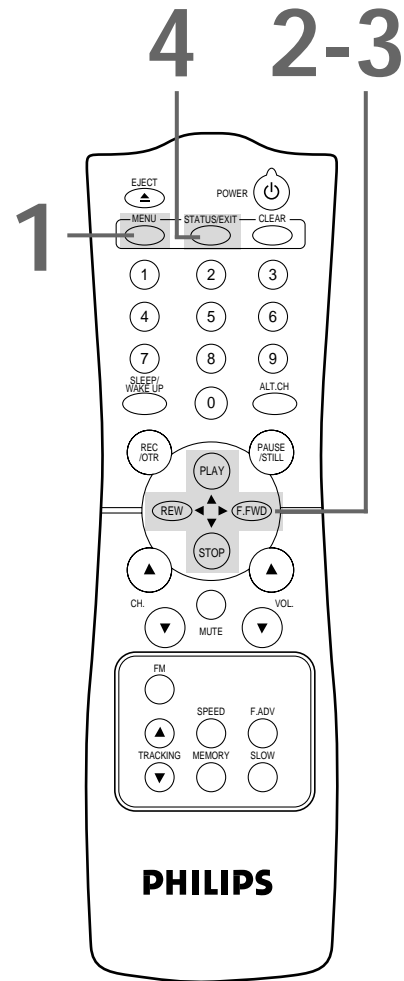

Helpful Hints

- The menus on page 25 will disappear if you do not make adjustments within 60 seconds.
- The original settings will probably give you the best picture quality.
- To reset the picture controls to the original settings, press the MENU button, then press the PLAY/▲ button or the STOP/▼ button to select TV RESET, then press the F.FWD/▶ button. TV RESET COMPLETED will appear on the screen briefly.

Adjusting the Picture Controls (cont'd) 25

	Decrease	Increase
BRIGHTNESS	decreased brightness	increased brightness
PICTURE	decreased contrast	increased contrast
COLOR	paler	more brilliant
TINT	more purple	more green
SHARPNESS	softer	clearer

CCC133

Press the REW(ind)/◀ button to decrease a picture control. Press the F.FWD/▶ button to increase a picture control.

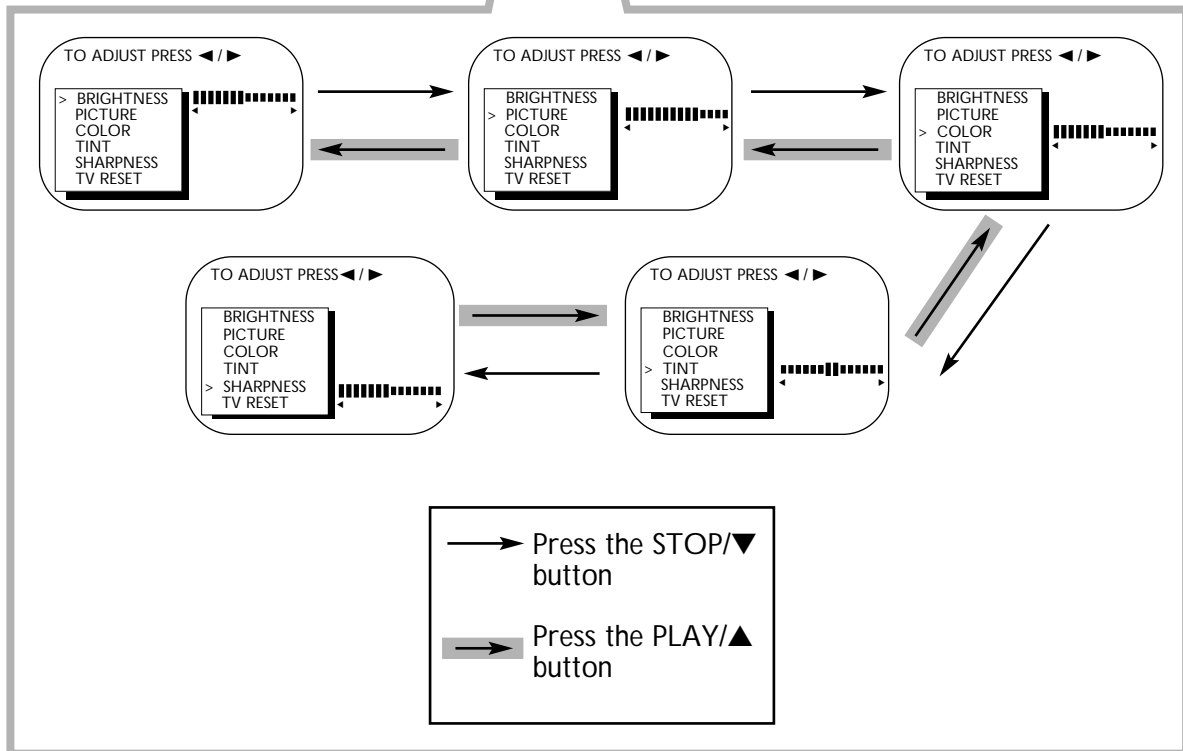
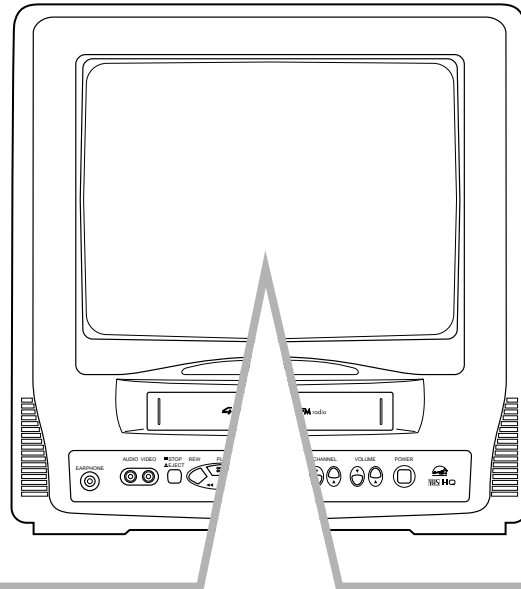

26 On-Screen Status Displays

A status display will appear when you press the STATUS/EXIT button or certain function buttons. The contents of the status display will vary. To choose the status display mode, follow the steps below.

If you select **STATUS ON**, then select **COUNTER ONLY OFF**:

- Whenever you press the STOP/▼ button or the PLAY/▲ button, the status display will appear for five seconds. Portions of the status display also may appear when you press other function buttons.

If you select **STATUS ON**, then select **COUNTER ONLY ON**:

- Whenever you press the PLAY/▲ button, the status display will appear for five seconds. After five seconds, only the counter will remain on the screen. Portions of the status display also may appear when you press other function buttons.

If you select **STATUS OFF**:

- The status display will not appear when you press function buttons. You must press the STATUS/EXIT button to see the status display.

1

Press the MENU button.

2

Press the PLAY/▲ button or the STOP/▼ button to select VCR SETUP, then press the F.FWD/▶ button.

3

Press the PLAY/▲ button or the STOP/▼ button to select ON-SCREEN MODE, then press the F.FWD/▶ button.

4

Press the PLAY/▲ button or the STOP/▼ button to select STATUS, then press the F.FWD/▶ button so that ON or OFF appears beside STATUS.

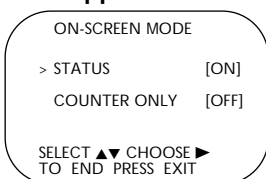

5

If you set STATUS to OFF, go to step 6. If you set STATUS to ON, press the PLAY/▲ button or the STOP/▼ button to select COUNTER ONLY, then press the F.FWD/▶ button so that ON or OFF appears beside it.

6

Press the STATUS/EXIT button.

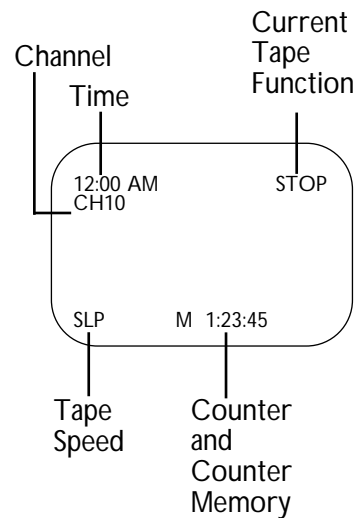

Helpful Hint

- You cannot view closed captions during recording or tape playback if COUNTER ONLY is ON. Details are on pages 50-51.

Reminder 27

The channel number will remain on the screen at all times when you set REMINDER to ON. The exception is when closed captioning is selected.
Set REMINDER to ON or OFF by following the steps below.

1

Press the MENU button.

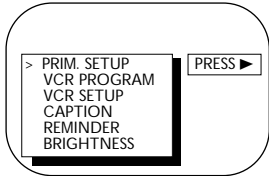

2

Press the PLAY/▲ button or the STOP/▼ button to select REMINDER.

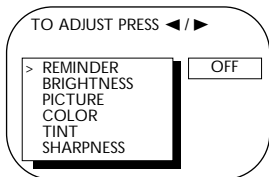

3

Press the REW(ind)/◀ button or the F.FWD/▶ button to select ON or OFF. Each press of the REW(ind)/◀ button or the F.FWD/▶ button turns REMINDER ON or OFF.

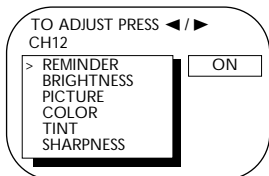

4

Press the STATUS/EXIT button.

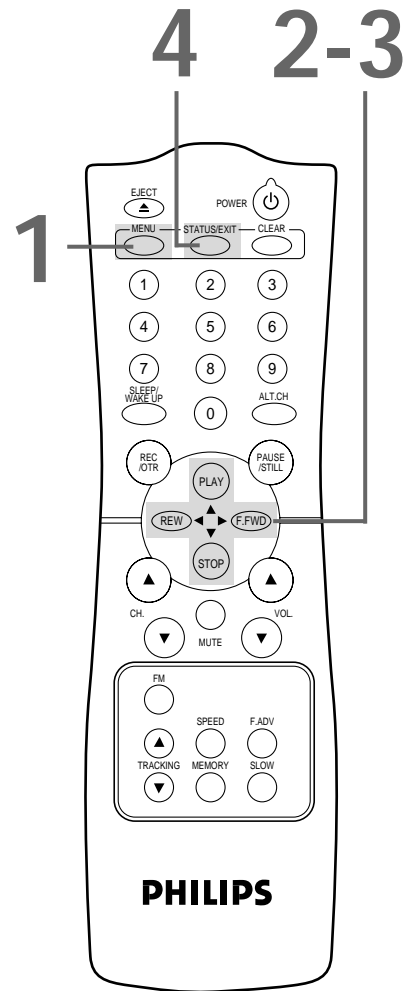

28 Playing

Follow the steps below to play a tape.

1

Insert a tape in the TV/VCR. The power will come on. If the tape's record tab is missing, playback should start automatically.

2

If playback does not start automatically, press the PLAY/▲ button to start playback.

3

Press the STOP/▼ button to stop playback.

4

Press the REW(ind)/◀ button to rewind the tape.

5

When the tape finishes rewinding, press the EJECT button to remove the tape.

1 Insert a tape in the TV/VCR.

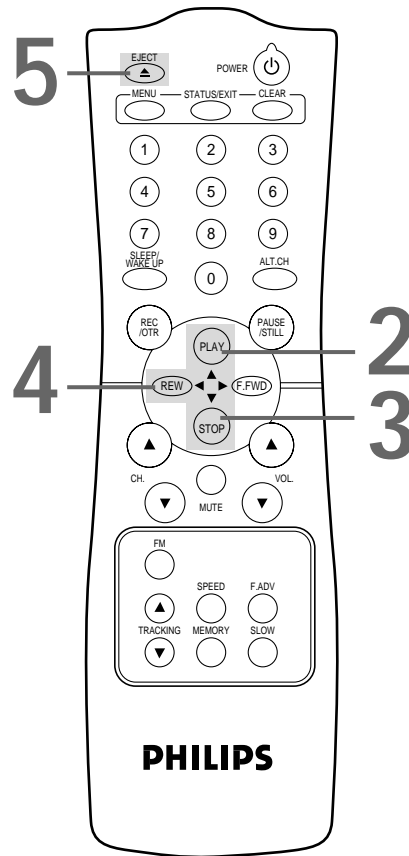

S-VHS Quasi Play Back (SQPB)

SQPB allows you to view a tape recorded in S-VHS format. An S-VHS format tape will play the same as a normal format tape. This unit detects whether the tape is in S-VHS format or normal format.

Helpful Hints

- If the tape you want to play is already in the TV/VCR, turn on the TV/VCR power, then press the PLAY/▲ button.
- Playback features and options are on pages 37-41.
- When you play an S-VHS format tape, you can not get the high resolution that would be available on an S-VHS VCR. Noise lines (black and white streaks) may appear in the picture.

Read and follow the steps below to record a TV program.

1

Place a tape with its record tab intact (see page five) in the TV/VCR. The power will come on. Or, if the tape is already in the TV/VCR, press the **POWER** button to turn on the TV/VCR, if necessary.

2

Press the **SPEED** button until the desired tape speed appears on the TV/VCR screen. See *tape speed details below*.

3

Use the **CH(annel) ▲/▼** buttons or the **Number** buttons to select the channel you want to record. You can not change channels during recording.

4

Press the **REC(ord)/OTR** button once to start recording.

The Record light will glow.

- If there is not a tape in the TV/VCR, **NO CASSETTE** flashes on the screen briefly.
- If the tape does not have a record tab, **PROTECTED CASSETTE CANNOT RECORD** flashes on the screen briefly. The TV/VCR will eject the tape. Insert another tape.

5

To pause the recording (for example, during commercials), press the **PAUSE/STILL** button. The Record light will flash. To resume recording, press the **PAUSE/STILL** button again or the **REC(ord)/OTR** button. The Record light will glow.

6

To stop recording, press the **STOP/▼** button.

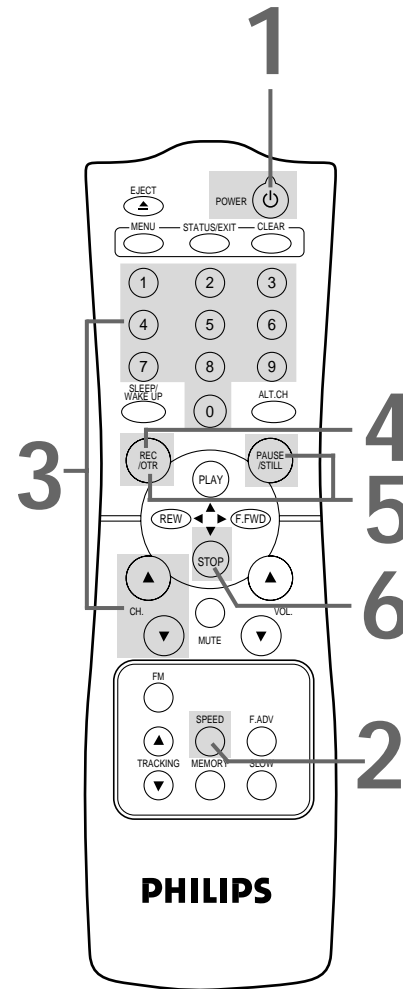

Tape Speeds

This chart shows the recording/playback time for three types of video cassettes (T160, T120, and T60). There are three playback speeds: SP, LP, and SLP. A tape will play only in the speed in which it was recorded. When recording, you can change the tape speed using the **SPEED** button. You cannot record in LP speed on this TV/VCR. The slower the speed, the more programming you can fit on the tape. SLP is the slowest speed.

Tape Speed	Cassette type / Playback Time		
	T160	T120	T60
SP(Standard Play)	2 hrs. 40 mins.	2 hrs.	1 hr.
LP(Long Play) (playback only)	5 hrs. 20 mins.	4 hrs.	2 hrs.
SLP(Super Long Play)	8 hrs.	6 hrs.	3 hrs.

Helpful Hints

- You cannot record one channel while watching another.
- Recording options are on pages 30-36.
- You cannot record if **DEFEAT RECORDING** is ON. (**REC DEFEATED** will flash on the screen.) Details are on page 36.
- If you pause a recording for more than five minutes, the TV/VCR will switch to Stop mode automatically to protect the video cassette tape from damage.
- You can change the tape speed with the **SPEED** button while a recording is in progress, but some distortion may appear on the tape.

30 One-Touch Recording

A One-Touch Recording (OTR) is an immediate timed recording from 30 minutes to eight hours long.

Before you begin, make sure:

- Channels are set. *Details are on page 10.*
- A tape is in the TV/VCR. The record tab must be intact.

1

Use the CH(annel) ▲/▼ buttons or the Number buttons to select the channel you want to record.

2

Press the SPEED button until the desired recording speed (SP or SLP) appears on the screen. *Details are on page 29.*

3

Press the REC(ord)/OTR button repeatedly until the desired recording length appears in the upper right corner of the screen. Recording will begin immediately. The Record light will appear. The TV/VCR will turn off at the end of the OTR.

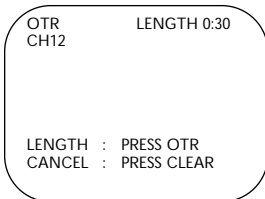

4

To stop an OTR before recording is finished, press the STOP/EJECT button on the TV/VCR.

Or, press the REC(ord)/OTR button, then press the CLEAR button, then press the STOP/▼ button on the remote control.

4

Press the STOP/EJECT button on the TV/VCR to stop the OTR.

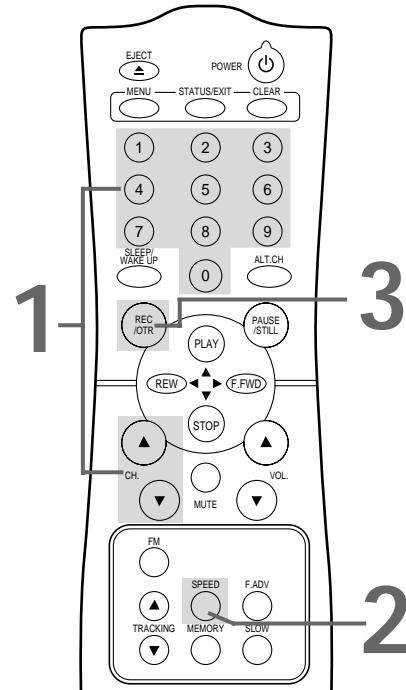

Helpful Hints

- To check the time remaining for an OTR, press the STATUS/EXIT button.
- To change the recording length while an OTR is in progress, press the REC(ord)/OTR button until the desired recording length appears on the screen.
- You can not pause an OTR.
- To cancel an OTR but continue recording, press the REC(ord)/OTR button, then press the CLEAR button.
- You cannot record if DEFEAT RECORDING is ON. *Details are on page 36.*
- You can change the tape speed with the SPEED button while a recording is in progress, but some distortion may appear on the tape.
- If the end of the tape is reached during an OTR, the TV/VCR will eject the tape and turn itself off. The Record light will flash rapidly.

Rerecording (Tape Duplication) 31

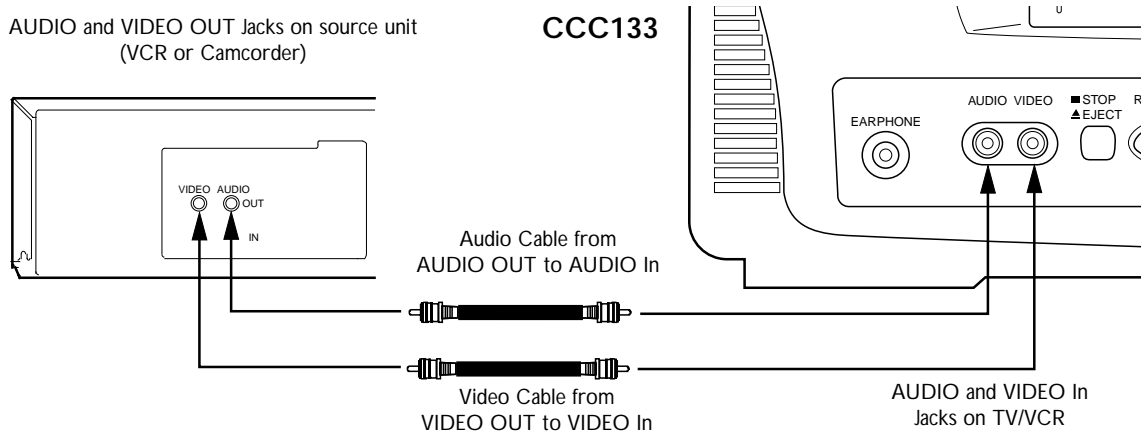

1

Make the connections shown above, using audio and video cables (not supplied). Connect the source unit (VCR or camcorder) to a power source after connections are made.

2

The source unit will play your tape. **Insert a prerecorded tape in the source unit.** If playback begins, press the STOP button on the unit.

3

The TV/VCR will record your tape. **Insert a blank tape in the TV/VCR.** Make sure the tape's record tab is intact. The TV/VCR power will turn on automatically.

4

Point the TV/VCR remote control at the TV/VCR. Press Number buttons 0, 0 so that A/V IN appears on the screen. The TV/VCR is now in Line Input mode.

5

Point the TV/VCR remote control at the TV/VCR. Press the SPEED button until the desired tape speed (SP or SLP) appears on the screen.

6

Press the PLAY button on the source unit and the REC(ord)/OTR button on your TV/VCR at the same time. Copying will begin.

7

To stop copying, press the STOP/EJECT button on the TV/VCR, then stop the tape on the source unit (VCR or camcorder).

Helpful Hints

- Unauthorized recording of copyrighted television programs, video tapes, or other materials may infringe on the rights of copyright owners and violate copyright laws.
- If a program has copyright protection, it may not record clearly.
- Different brands of equipment may operate differently.
- Make sure all connections are secure. Otherwise, you may not record both picture and sound.

32 Timer Recording

Follow the steps below to program the TV/VCR to record TV programs while you're away from home. The TV/VCR will turn itself on, record, and turn itself off automatically. (The Record light will be on steadily during the recording. Before you begin, make sure:

- The clock is set. If not, CLOCK MUST BE SET appears, followed by the SET CLOCK menu. *Details are on pages 12-17.*
- Channels are set. *Details are on page 10.*
- A tape is in the TV/VCR. Make sure the tape's record tab is intact and the tape is long enough to record the program.

Complete each step within 60 seconds of completing the previous step. If you don't, you may start again at step 1.

1

Press the MENU button.

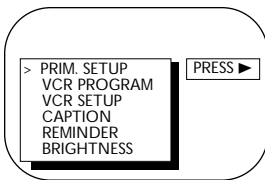

2

Press the PLAY/▲ button or the STOP/▼ button to select VCR PROGRAM, then press the F.FWD/▶ button.

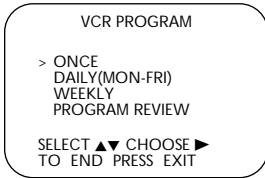

3

Press the PLAY/▲ button or the STOP/▼ button to select a ONCE, DAILY, OR WEEKLY recording. Then, press the F.FWD/▶ button.

- **ONCE:** The TV/VCR will record a TV program on any day you choose, up to 12 months away.
- **DAILY:** The TV/VCR will record every day from Monday to Friday – starting at the same time and recording the same channel for the same length of time.
- **WEEKLY:** The TV/VCR will record the same channel on the same day, at the same time, and for the same length of time every week.

Daily Recording (example)

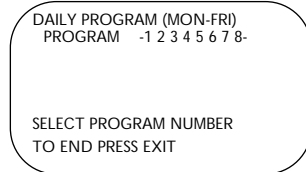

2-3

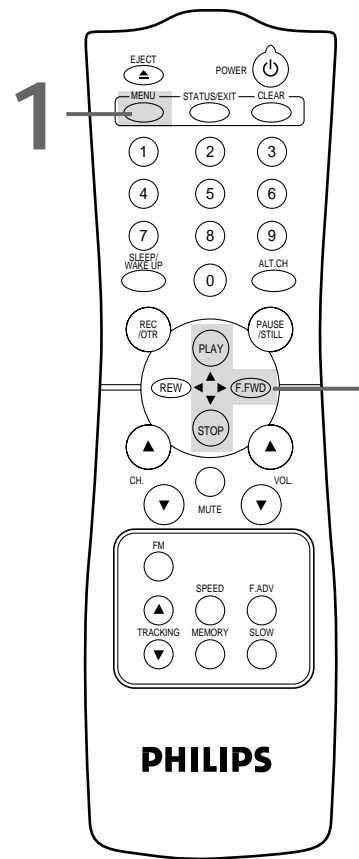

Helpful Hints

- With ShowGuard, you don't have to worry about losing your timer recordings. If the power fails, timer recordings will be restored when the clock is reset. (The clock will reset itself automatically if you are using AUTO CLOCK. Details are on pages 14-17. If you are not using AUTO CLOCK, reset the clock manually. Details are on pages 12-13.) The timer recording will not occur only if it was scheduled to take place during the power failure.
- You cannot set a timer recording if DEFEAT RECORDING is ON. Details are on page 36.

4

Use the Number buttons (1-8) to select a position in which to store the timer recording. Flashing numbers indicate an open position (one in which a timer recording has not been stored yet).

NOTE: If you select a number that already has been used to store a timer recording, PREVIOUSLY SET PROGRAM will appear on the screen for a few seconds. Then information about the program in that position will appear on the screen. If this happens, press the STATUS/EXIT button. Then use the Number buttons to select another position.

5

Use the Number buttons to enter the channel of the TV program you want to record.

- If you are recording from line input, press 0. 0. A/V IN will appear on the screen.
- If you are recording using a Cable Box, enter the Cable Box output channel (03 or 04). Be sure to select the channel of the TV program at the Cable Box and leave the Cable Box on for the timer recording.

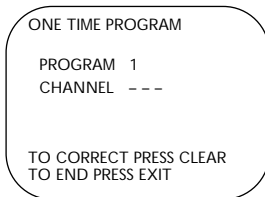

6

Press two Number buttons for the hour(s) you want the recording to begin. Press two Number buttons for the minute(s) you want the recording to begin. Press 1 for AM or 2 for PM. For example, for 9:30 PM, press 09, 30, 2.

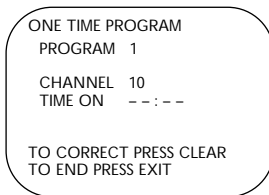

7

Follow the instructions in step 6 to set the recording's stop time. (AM or PM will be set automatically.)

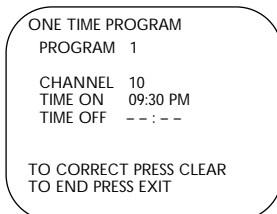

Instructions continue on page 34.

4-7

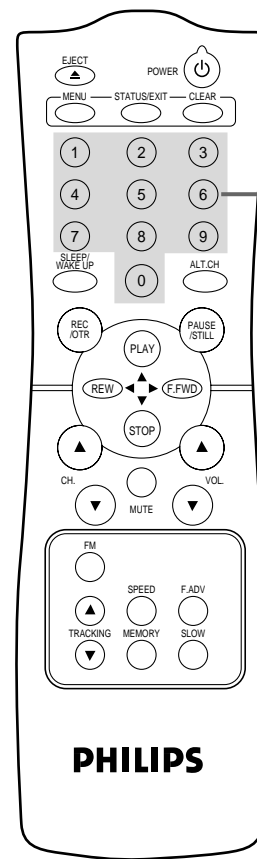

Helpful Hints

- If you enter numbers that do not match the TV/VCR's clock or calendar, the entry will be rejected and a question mark will appear on the screen.
- To make corrections while you are programming a timer recording, press the CLEAR button until the cursor is flashing on the item you want to change. Then enter the correct information.

34 Timer Recording (cont'd)

8

Press the **Number 1** button to record in SP speed or press the **Number 2** button to record in SLP speed. Details about tape speed are on page 29. You cannot use the SPEED button at this time.

ONE TIME PROGRAM

PROGRAM 1
CHANNEL 10
TIME ON 09:30 PM
TIME OFF 11:00 PM
REC SPEED SLP
SP=1 SLP=2

TO CORRECT PRESS CLEAR
TO END PRESS EXIT

9

Press two **Number** buttons for the month and two **Number** buttons for the day you want the program to record. For example, for July 10, 2001, press 07, 10. The day of the week and the year will appear automatically. (You cannot program the TV/VCR to record more than one year in advance.)

ONE TIME PROGRAM

PROGRAM 1
CHANNEL 10
TIME ON 09:30 PM
TIME OFF 11:00 PM
REC SPEED SLP
START DATE 07/10/2001
TUESDAY

TO CORRECT PRESS CLEAR
TO END PRESS EXIT

10

Press the **STATUS/EXIT** button. PROGRAM WAS COMPLETED PLEASE TURN OFF FOR TIMER RECORDING will appear on the screen.

- If there is not a tape in the TV/VCR, PLEASE INSERT CASSETTE also appears on the screen.
- If there is a tape without a record tab in the TV/VCR, PLEASE REMOVE CASSETTE also appears on the screen. If this happens, insert a different tape.
- If PROGRAM NOT COMPLETED appears, start again at step 1.

11

Press the **POWER** button to turn off the TV/VCR power. The Record light will flash slowly. If you forget to turn off the TV/VCR, PLEASE TURN OFF FOR TIMER RECORDING appears on the TV/VCR screen two minutes before a timer recording should begin. The Record light will flash rapidly.

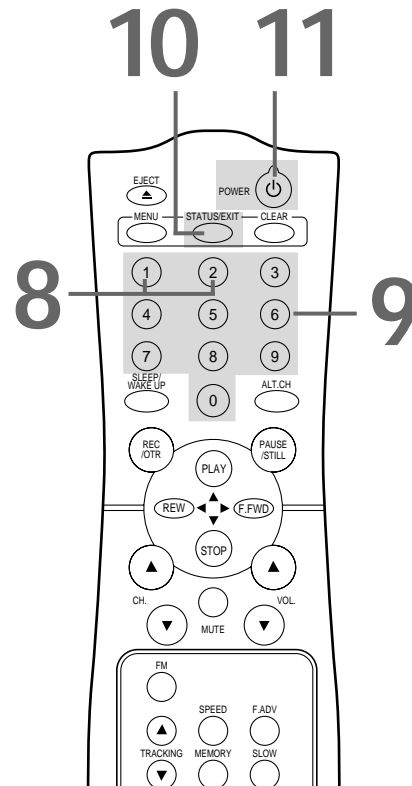

Turn off the TV/VCR for the recording. Insert a tape in the TV/VCR. Leave the Cable Box/DBS on (if applicable).

Helpful Hints

- PROGRAM NOT COMPLETED / CLASH may appear on the screen when you finish setting a timer recording. This means the timer recording you just tried to program overlaps with another timer recording. The latest timer recording will not occur.
- To stop a timer recording that is in progress, press the STOP/EJECT button on the TV/VCR once. Please see page 54 for more Helpful Hints.

Checking or Clearing Timer Recordings

1

With the TV/VCR on, press the MENU button.

2

Press the PLAY/▲ button or the STOP/▼ button to select VCR PROGRAM, then press the F.FWD/▶ button.

3

Press the PLAY/▲ button or the STOP/▼ button to select PROGRAM REVIEW, then press the F.FWD/▶ button.

The timer recording information for the program in the lowest numbered position will appear on the screen. If no timer recordings are programmed, nothing will happen when you select PROGRAM REVIEW and press the F.FWD/▶ button.

4

Press the F.FWD/▶ button to display information about the next timer recording. (If you do not press a button within 10 seconds, information about the next timer recording will appear automatically.) This will continue until all positions have been displayed. Then, the menu will disappear. You can exit the Program Review at any time by pressing the STATUS/EXIT button.

5

To cancel the timer recording displayed, press the CLEAR button. Either the display will disappear or information about other timer recordings will appear. If you do not press any other buttons, the display will disappear after all timer recordings have been displayed.

6

Repeat steps 1-4 to make sure you cleared the correct recording.

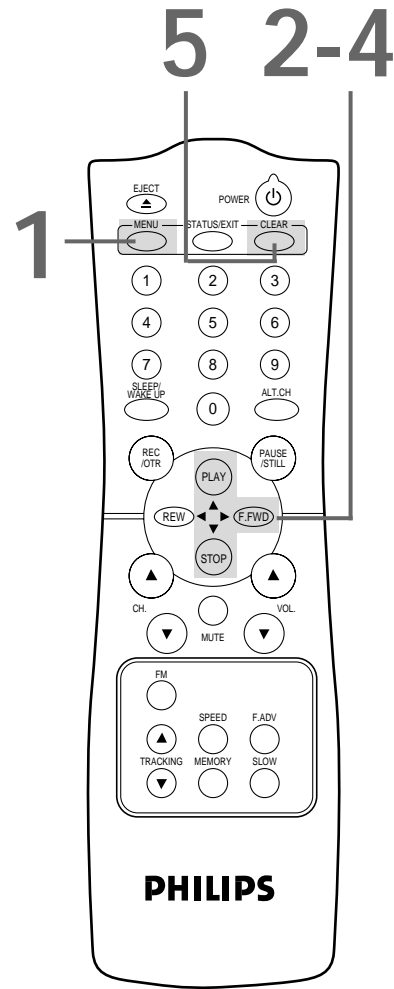

Helpful Hint

- With ShowGuard, you don't have to worry about losing your timer recordings. If the power fails, timer recordings will be restored when the clock is reset. (The clock will reset itself automatically if you are using AUTO CLOCK. Details are on pages 14-17. If you are not using AUTO CLOCK, reset the clock manually. Details are on pages 12-13.) The timer recording will not occur only if it was scheduled to take place during the power failure.

36 Defeat Recording

Follow the steps below to prevent accidental recording.

1

Press the MENU button.

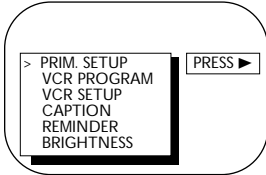

2

Press the PLAY/▲ button or the STOP/▼ button to select VCR SETUP, then press the F.FWD/► button.

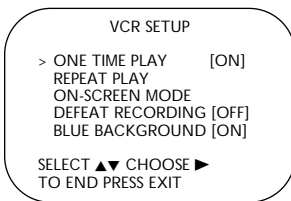

3

Press the PLAY/▲ button or the STOP/▼ button to select DEFEAT RECORDING, then press the F.FWD/► button so that ON appears beside DEFEAT RECORDING.

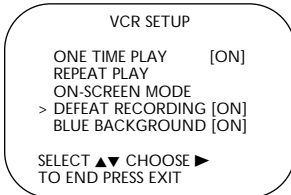

4

Press the STATUS/EXIT button.

5

Now, REC DEFEATED will flash on the screen when you press the REC(ord)/OTR button.

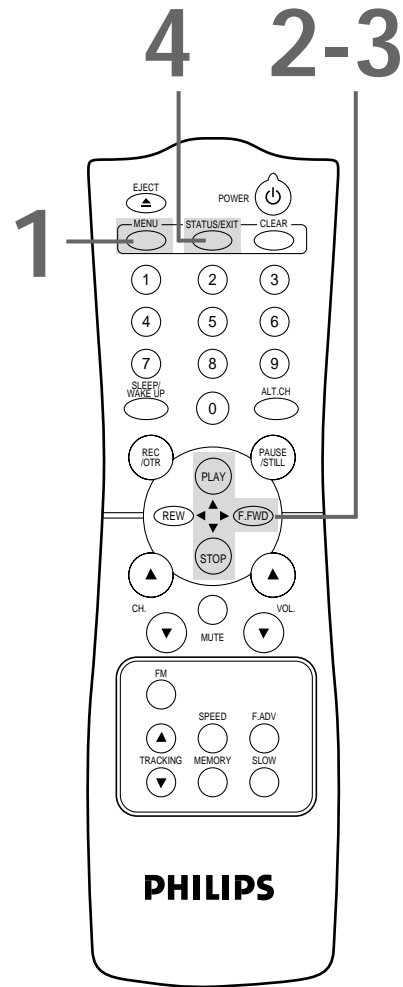
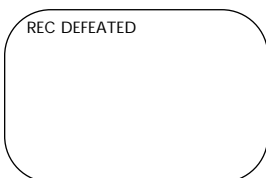

Helpful Hints

- If you set DEFEAT RECORDING to ON after you program a timer recording, the timer recording will not occur. The TV/VCR will not remind you of the timer recording as described on page 34.
- You can not program a timer recording if DEFEAT RECORDING is ON.
- To set DEFEAT RECORDING to OFF, repeat steps 1-2 above. At step 3, press the PLAY/▲ button or the STOP/▼ button to select DEFEAT RECORDING, then press the F.FWD/► button so that OFF appears beside DEFEAT RECORDING. Press the STATUS/EXIT button.

Repeat Play 37

Follow the steps below to program the TV/VCR to play a tape over and over.

1

Press the **MENU** button.

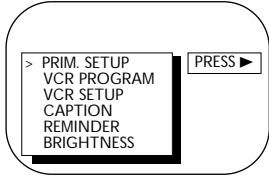

2

Press the **PLAY/▲** button or the **STOP/▼** button to select **VCR SETUP**, then press the **F.FWD/►** button.

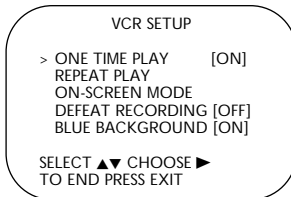

3

Press the **PLAY/▲** button or the **STOP/▼** button to select **REPEAT PLAY**, then press the **F.FWD/►** button so that **ON** appears beside **REPEAT PLAY**.

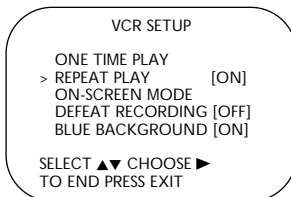

4

Press the **STATUS/EXIT** button. Now, when a tape finishes playing, the TV/VCR will rewind it and start playback again. (TV programming will appear while the tape is rewinding.)

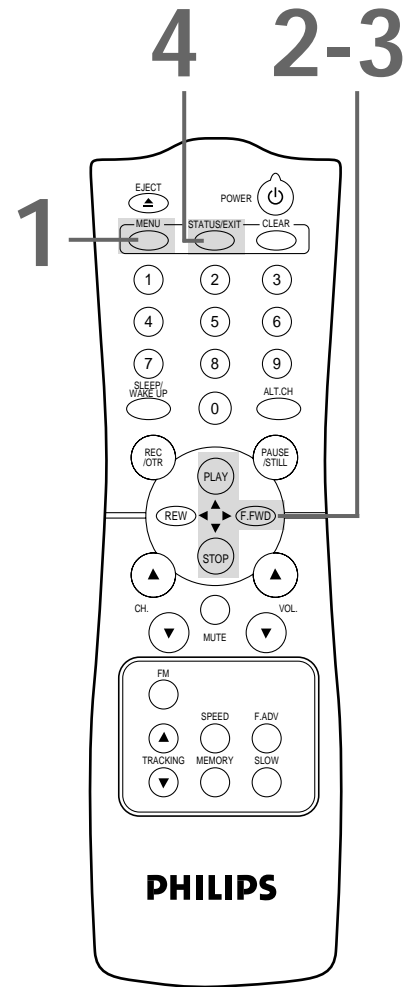

Helpful Hints

- The TV/VCR will stay in Repeat Play mode until you set **ONE TIME PLAY** to **ON**, even if you turn off the TV/VCR. To set **ONE TIME PLAY** to **ON**, follow steps 1-2 above. Then, press the **PLAY/▲** button or the **STOP/▼** button to select **ONE TIME PLAY**. Press the **F.FWD/►** button so that **ON** appears beside **ONE TIME PLAY**. Then, press the **STATUS/EXIT** button.
- The real-time counter memory will not function during Repeat Play mode.

38 A-B Repeat Play

Follow the steps below to program the TV/VCR to play the material between two specified points (A and B) on a tape over and over again.

1

Insert a tape in the TV/VCR.

2

Press the MENU button.

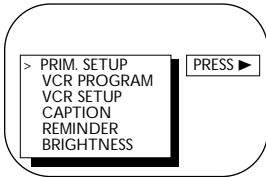

3

Press the PLAY/▲ button or the STOP/▼ button to select VCR SETUP, then press the F.FWD/► button.

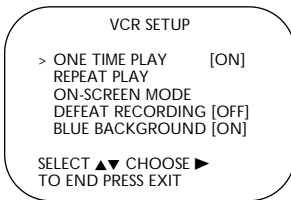

4

Press the PLAY/▲ button or the STOP/▼ button to select REPEAT PLAY.

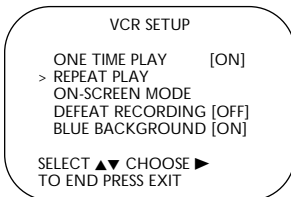

5

Press the F.FWD/► button repeatedly so that A-B appears beside REPEAT PLAY.

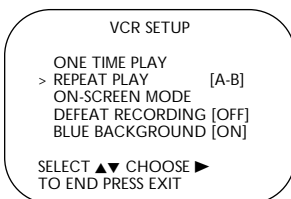

1

Insert a tape in the TV/VCR.

2

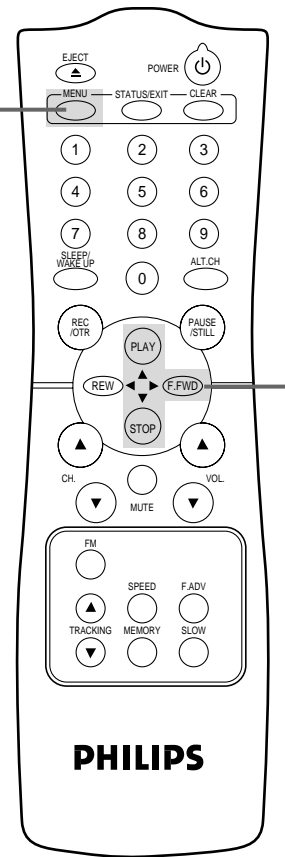

3-5

Helpful Hints

- To cancel A-B Repeat Play, set ONE TIME PLAY to ON. To set ONE TIME PLAY to ON, follow steps 2-3 above. Then, press the PLAY/▲ button or the STOP/▼ button to select ONE TIME PLAY. Press the F.FWD/► button so that ON appears beside ONE TIME PLAY. Then, press the STATUS/EXIT button.
- The end position (B) must be later on the tape than the start position (A).

6

Press the **STATUS/EXIT** button to remove the menu. A-B REPEAT will appear on the screen. Beneath it, the letter A will flash beside the real-time counter.

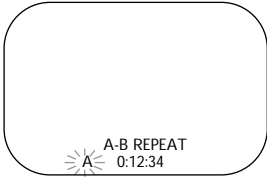

7

Play, fast forward, or rewind the tape to the position at which you want to begin playback. Stop the tape, then press the **MEMORY** button to set the start position (A). The flashing A will become a flashing B.

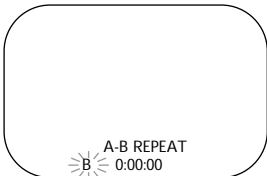

8

Play or fast forward the tape to the position at which you want playback to end. Stop the tape, then press the **MEMORY** button to set the end position (B).

- The length of time between the start position (A) and the end position (B) must be at least three minutes.

9

The TV/VCR will immediately rewind the tape to the start position (A) and repeat playback to the end position (B) over and over.

(TV programming will appear while the tape is rewinding.)

6 7-8

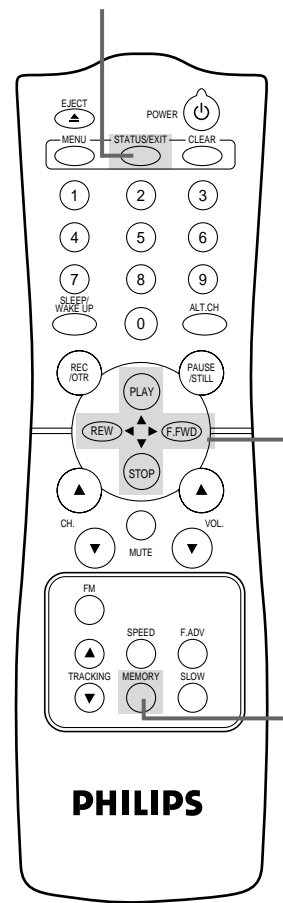

Helpful Hints

- The counter cannot be memorized or reset when you are using this feature.
- A-B Repeat Play will be cancelled if you eject the tape or press the REC(ord)/OTR button.
- A-B REPEAT will not appear on the screen at step 6 if a tape is not in the TV/VCR. NO CASSETTE will flash on the screen briefly.
- You cannot rewind or fast forward beyond points A or B when you are using this feature.
- A-B Repeat Play will be retained if you turn off the TV/VCR power.

40 Real-Time Counter Memory

Follow the steps below to reset the real-time counter to zero at a tape location you want to refer to later.

1

Play, fast forward, or rewind a tape to the location that you would like to refer to later. Stop the tape.

2

Press the **STATUS/EXIT** button. The real-time counter will appear on the screen.

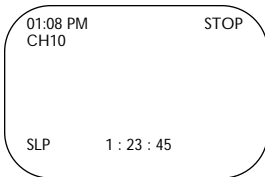

3

While the counter remains on the screen, press the **CLEAR** button to reset the real-time counter to zero.

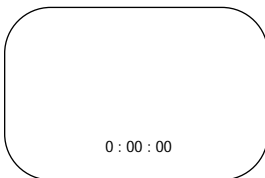

4

While the counter remains on the screen, press the **MEMORY** button so that **M** appears on the screen. To erase a real-time counter memory, press the **MEMORY** button so that the **M** disappears from the screen.

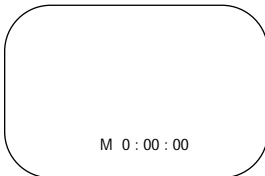

5

To go to the tape location where you set the real-time counter to zero, press the **REW(ind)/◀** button or the **F.FWD/▶** button when playback is stopped. When the tape reaches the point at which you set the counter to zero, the tape will stop. Press the **PLAY/▲** button to watch the tape.

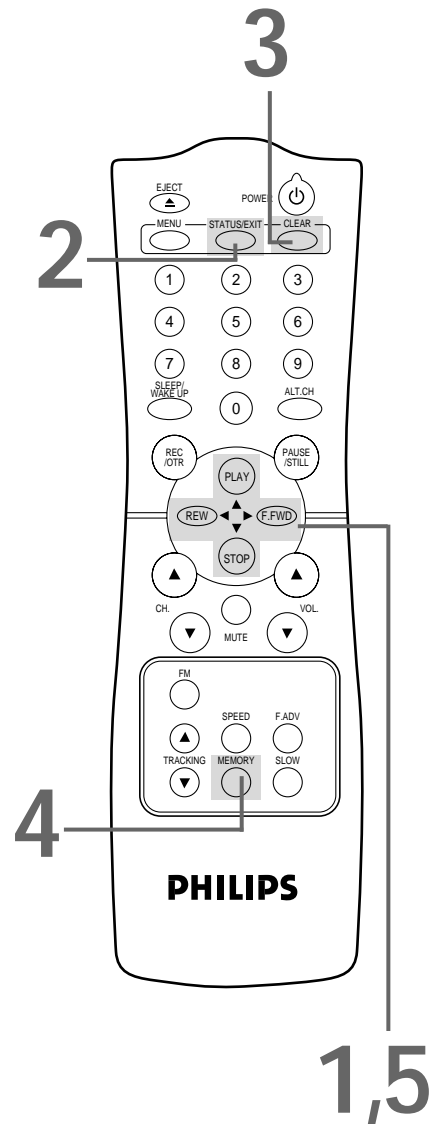

Helpful Hints

- The real-time counter memory will not function during Repeat Play mode. Details are on page 37.
- You may only set one real-time counter memory at a time. If you set the real-time counter to zero at a second location, the previous real-time counter to zero setting will be lost.

Forward and Reverse Searching (SP/LP/SLP)

1

During tape playback, press and release the F.FWD/▶ button or the REW(ind)/◀ button. A fast forward or reverse picture search will begin.

2

To return to normal playback, press the PLAY/▲ button.

Super High Speed Searching (LP/SLP)

1

During tape playback, press the F.FWD/▶ button or the REW(ind)/◀ button, then press again. The TV/VCR will now search in super high speed.

Press the F.FWD/▶ button or the REW(ind)/◀ button repeatedly to switch between regular and super high speed searching.

2

To return to normal playback, press the PLAY/▲ button.

Viewing a Still Picture

1

During tape playback, press the PAUSE/STILL button. A still picture will appear on the screen.

2

To advance the still picture frame-by-frame, press the F(rame). ADV(ance) button.

3

To release the still picture and return to normal playback, press the PLAY/▲ button or press the PAUSE/STILL button again.

Viewing a Slow Motion Picture

1

During tape playback, press the SLOW button. The tape will play in slow motion.

2

To release Slow mode and return to normal playback, press the PLAY/▲ button.

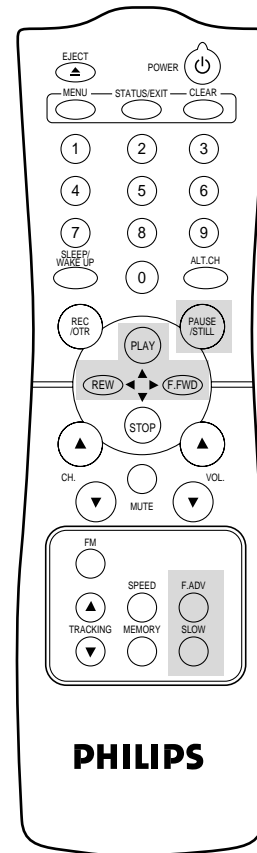

Helpful Hints

- Still and Slow modes will automatically switch to Stop mode after five minutes to protect the TV/VCR and the tape from damage.
- SP/LP/SLP means this feature will work with tapes recorded in Standard Play, Long Play, or Super Long Play. For details about tape speed, see page 29.
- LP/SLP means this feature will work with tapes recorded in Long Play and Super Long Play. For details on tape speed, see page 29.
- During forward and reverse searching, horizontal noise bars will appear on the TV/VCR screen.

42 SmartLock

SmartLock enables parents to prevent their children from watching inappropriate material on TV.

SmartLock reads the ratings for programming (except for news and sports programs, unedited movies on premium cable channels, and Emergency Broadcast System signals), then denies access to programming if the program's rating meets or exceeds the limitations you select. The ratings are defined on page 45.

To block ratings, follow the steps below.

1

Press the MENU button.

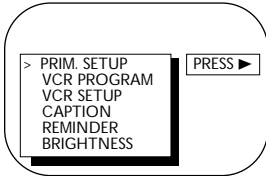

2

Press the PLAY/▲ button or the STOP/▼ button to select SMARTLOCK. Then, press the F.FWD/▶ button.

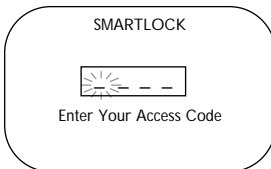

3

Use the Number buttons to enter your access code.

The default code is 0711. If you have not set up your personal access code, you should use 0711. (To set up your personal access code, see page 44.)

The SMARTLOCK menu will appear.

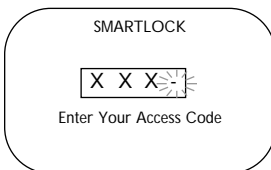

4

Press the PLAY/▲ button or the STOP/▼ button to select BLOCK. Then, press the F.FWD/▶ button.

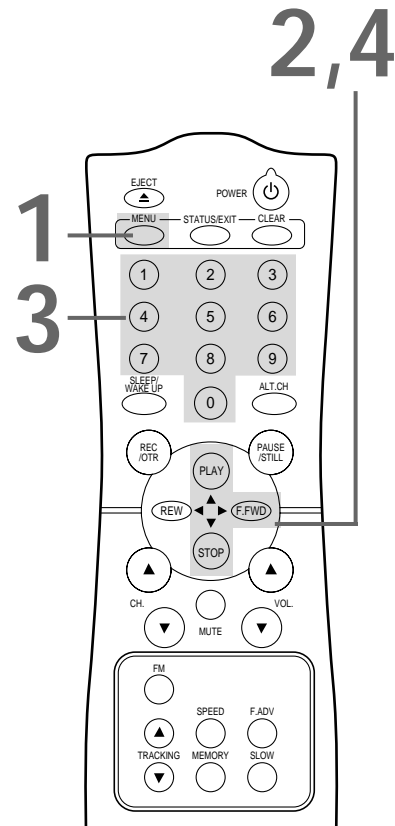
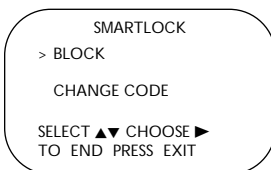

Helpful Hints

- If the "Incorrect Access Code..." message appears after step 3, enter the correct access code.
- Programming may be rated by the Motion Picture Association of America (MPAA) or according to the Television Parental Guidelines. In order to block any inappropriate programming, set your limits in both places (Movie Ratings and Parental Guidelines). You will complete steps 1-7 twice, choosing Movie Ratings at step 5 the first time, then choosing Parental Guidelines at step 5 the second time.
- You can not view tape playback if the rating of the tape is blocked.
- If you enter the access code once, you may change channels without seeing the "CHANNEL XX BLOCKED" message again. If you turn off the TV/VCR power, you will be asked for the access code again when you tune to a blocked channel.

5

Press the **PLAY/▲** button or the **STOP/▼** button to select **Movie Ratings** or **Parental Guidelines**. Then, press the **F.FWD/▶** button.

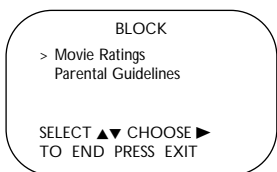

6

Press the **PLAY/▲** button or the **STOP/▼** button to select the rating you want to block. Then, press the **F.FWD/▶** button so that **ON** appears beside the rating.

For example, if you set PG to ON, you may not view PG programming because the block is on. Programs with a PG or higher rating will be blocked. A "CHANNEL XX BLOCKED..." message will appear when someone tries to access such programming.

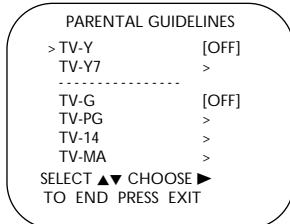
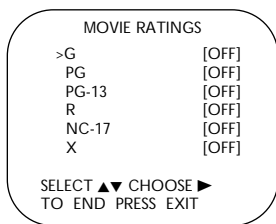

- More specific sub-ratings are available for TV-Y7, TV-PG, TV-14, and TV-MA. (See example below.) When you press the **F.FWD/▶** button to turn on TV-Y7, TV-PG, TV-14 or TV-MA, additional sub-ratings will appear.

If you select the rating category, such as TV-PG, and turn it on or off, the specific sub-ratings, such as V for Violence, will turn on or off automatically. You can always turn specific sub-ratings on or off by selecting them individually. However, you may only set a sub-rating to ON if the rating category is set to ON.

- Ratings are defined on page 45.

Example of specific sub-ratings

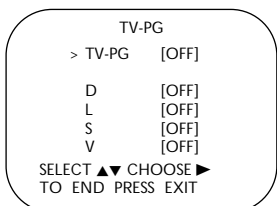

7

Press the **STATUS/EXIT** button.

7 5-6

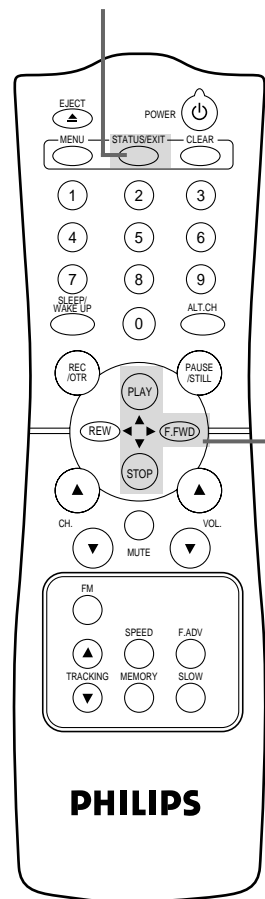

Helpful Hints

- If the "CHANNEL XX BLOCKED..." or "PLAYBACK BLOCKED..." message appears and you want to view this programming, enter your access code. The channel will remain blocked until you enter the correct code. If you do not know the code, you will have to use the CH(annel) ▲/▼ buttons to select another channel or press the STOP/▼ button.
- Ratings will remain blocked even after a power failure.
- You cannot access the menu when the "CHANNEL XX BLOCKED..." or "PLAYBACK BLOCKED..." message appears.

44 SmartLock (cont'd)

To change the access code, follow these steps.

1

Press the **MENU** button.

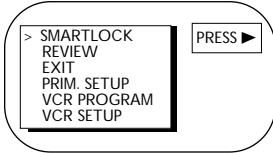

2

Press the **PLAY/▲** button or the **STOP/▼** button to select **SMARTLOCK**. Then, press the **F.FWD/►** button.

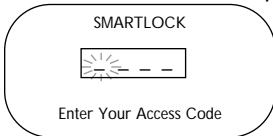

3

Use the **Number** buttons to enter your old access code. The default code is 0711. If you have never set up your personal access code, use 0711 now. After you enter the code, the SMARTLOCK menu will appear.

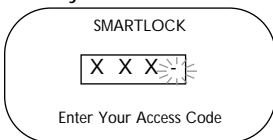

4

Press the **PLAY/▲** button or the **STOP/▼** button to select **CHANGE CODE**. Then, press the **F.FWD/►** button.

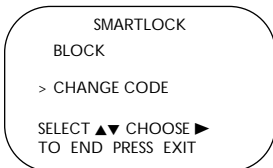

5

Use the **Number** buttons to enter your desired access code in the **New Code** space. Then, enter the same code in the **Confirm Code** space. Your new access code should be recorded. You will return to the SMARTLOCK menu.

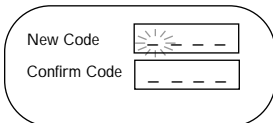

6

Press the **STATUS/EXIT** button.

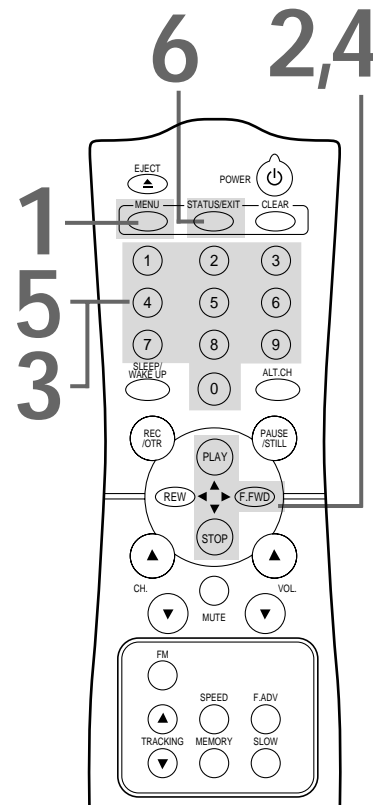

Helpful Hints

- To protect the privacy of the access code, an X will appear on the screen instead of the number you enter.
- If a "Wrong Code..." message appears on the screen after you complete step 5, you entered the wrong numbers in the Confirm Code space. Enter the new code again, then enter the exact same code in the Confirm Code space.
- You cannot use the default code after you set up your personal access code.
- If a power failure occurs, the default code, 0711, will be the active access code again.
- If you connect the power cord to an AC outlet that is controlled by a wall switch, your personal access code will be erased every time you turn off the power at the wall switch. The default code will be the active code again.

To check the SmartLock settings and see which ratings you have blocked, follow these steps.

1

Press the **MENU** button.

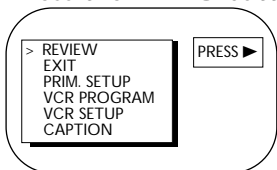

2

Press the **PLAY/▲** button or the **STOP/▼** button to select **REVIEW**. Then, press the **F.FWD/▶** button so that the **SmartLock settings appear**.

Ratings that are blocked will appear on the screen.

An "X" will appear if a specific sub-rating is blocked, such as V for Violence in the TV-14 category.

BLOCKED RATINGS				
Movie Ratings				
G	PG-13	NC-17		
Parental Guidelines				
TV-Y7				

TV-G	D	L	S	V
TV-PG			x	x
TV-14	x	x	x	x
TV-MA	-	x	x	x

3

Press the **STATUS/EXIT** button.

RATING EXPLANATIONS

For Movie Ratings

- G - General Audience
- PG - Parental Guidance suggested.
- PG-13 - Unsuitable for children under 13
- R - Restricted; under 17 requires accompanying parent or adult guardian
- NC-17 - No one under 17 admitted
- X - Mature audience only

For Parental Guidelines

- V - Violence
- S - Sexual situations
- L - Language
- D - Inappropriate dialogue
- FV - Fantasy Violence may frighten children under seven; TV-Y7 category only. Some cartoons may have this rating.
- TV-Y - Appropriate for all children
- TV-Y7 - Appropriate for children seven and older
- TV-G - General Audience
- TV-PG - Parental Guidance suggested.
- TV-14 - Unsuitable for children under 14
- TV-MA - Mature audience only

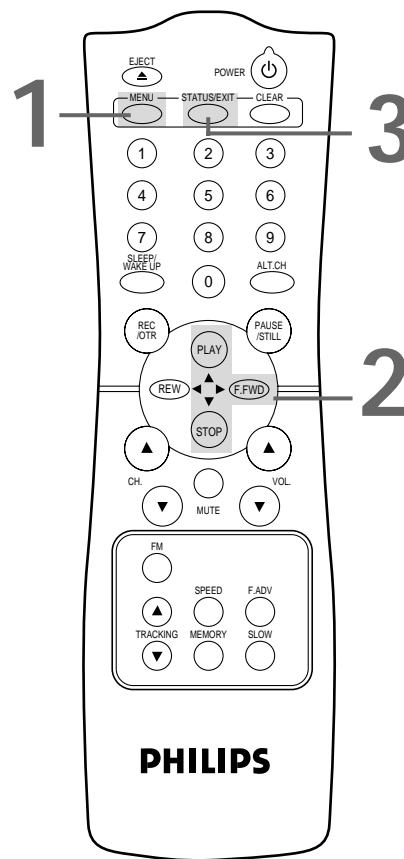

46 Blue Background

If you want the TV screen to be solid blue when a weak signal is received, set BLUE BACKGROUND to ON. The screen will be blue and the sound will be muted. Or, if you want to receive the weak signal, set BLUE BACKGROUND to OFF. When you select a channel that is receiving a weak signal, you will see and hear the static in the TV programming.

To set BLUE BACKGROUND to ON or OFF, follow the steps below.

1

Press the **MENU** button.

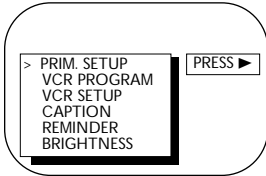

2

Press the **PLAY/▲** button or the **STOP/▼** button to select **VCR SETUP**, then press the **F.FWD/►** button.

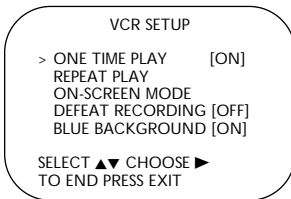

3

Press the **PLAY/▲** button or the **STOP/▼** button to select **BLUE BACKGROUND**. Then, press the **F.FWD/►** button repeatedly so that **OFF** (or **ON**) appears beside **BLUE BACKGROUND**.

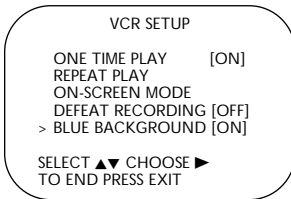

4

Press the **STATUS/EXIT** button.

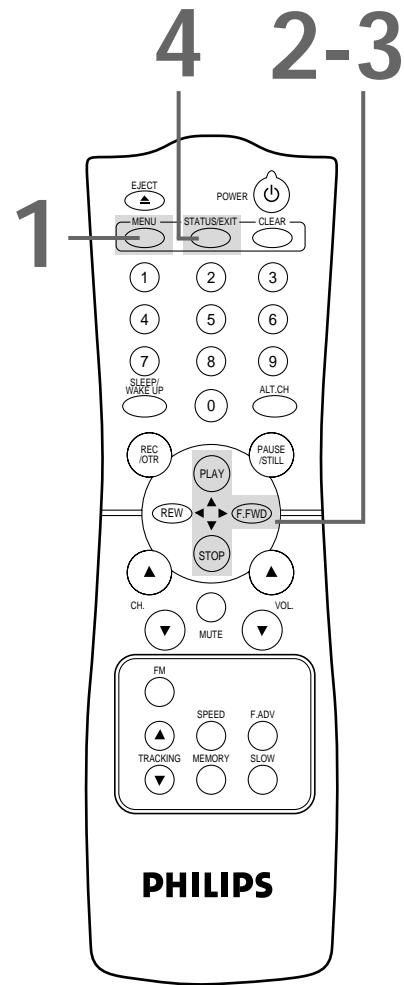

Helpful Hint

- A blue screen may appear briefly between channel changes if **BLUE BACKGROUND** is ON. To avoid having the brief blue screen, set **BLUE BACKGROUND** to OFF.

Sleep Timer 47

Use the sleep timer to program the TV/VCR to shut off in a certain amount of time.

1

Press the **SLEEP/WAKE UP** button.

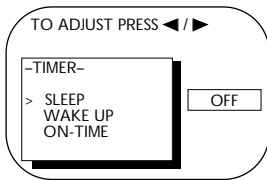

2

Press the **PLAY/▲** button or the **STOP/▼** button to select **SLEEP**. Then press the **REW(ind)/◀** button or the **F.FWD/▶** button to select **30 MIN(utes)**, **60 MIN(utes)**, **90 MIN(utes)**, or **120 MIN(utes)**. (You can not set the sleep timer during a recording.)

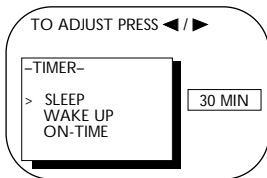

3

Press the **STATUS/EXIT** button. The TV/VCR will shut itself off after the specified amount of time. One minute before the TV/VCR shuts itself off, the seconds will count down on the screen. **GOOD NIGHT** appears on the TV/VCR screen 10 seconds before the TV/VCR shuts itself off.

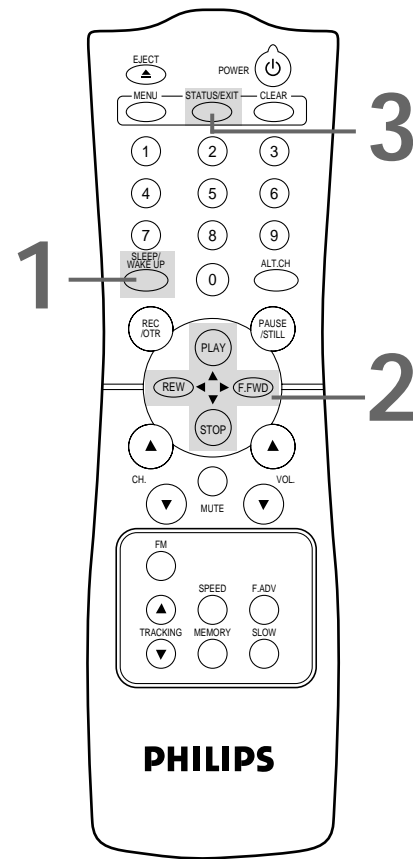

Helpful Hints

- To cancel the sleep timer, press the **SLEEP/WAKE UP** button. Press the **PLAY/▲** button or the **STOP/▼** button to select **SLEEP**, then press the **REW(ind)/◀** button or the **F.FWD/▶** button to select **OFF**. Press the **STATUS/EXIT** button.
- To see how much time remains before the TV/VCR shuts itself off, press the **SLEEP/WAKE UP** button once. If necessary, press the **PLAY/▲** button or the **STOP/▼** button to select **SLEEP**. The remaining time will appear beside **SLEEP**. To remove the display, press the **STATUS/EXIT** button.
- If you start a recording after you set the Sleep Timer, the Sleep Timer will be cancelled.

48 Wake Up Timer

The Wake Up Timer turns on the TV/VCR automatically at a specified time within the next 24 hours. You may set the TV/VCR to turn on at a TV channel (the channel at which the TV/VCR was set last) or with VCR playback. To set the Wake Up Timer, follow the steps below. Before you begin:

- Set the clock. If the clock is not set, CLOCK MUST BE SET will appear on the screen after you select WAKE UP at step 2. Then the SET CLOCK menu will appear. *Details are on pages 12-17.*
- Put a tape in the TV/VCR if you want the TV/VCR to start tape playback at the specified time.
- Make sure no timer recordings are set for the time at which you want the TV/VCR power to come on.

1

Press the SLEEP/WAKE UP button.

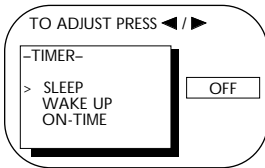

2

Press the PLAY/▲ button or the STOP/▼ button to select WAKE UP. Then, press the REW(ind)/◀ button or the F.FWD/▶ button to select TV ON or VCR ON.

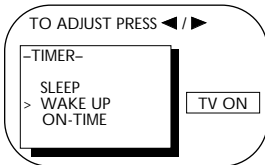

3

Press the PLAY/▲ button or the STOP/▼ button to select ON-TIME. Then, press the REW(ind)/◀ button or the F.FWD/▶ button to select your desired wake up time. Each press of the REW(ind)/◀ button or the F.FWD/▶ button will decrease (or increase) the time by 10 minutes.

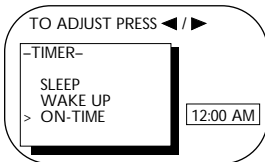

4

Press the STATUS/EXIT button.

5

Press the POWER button to turn off the TV/VCR. The TV/VCR will turn itself on at the specified time.

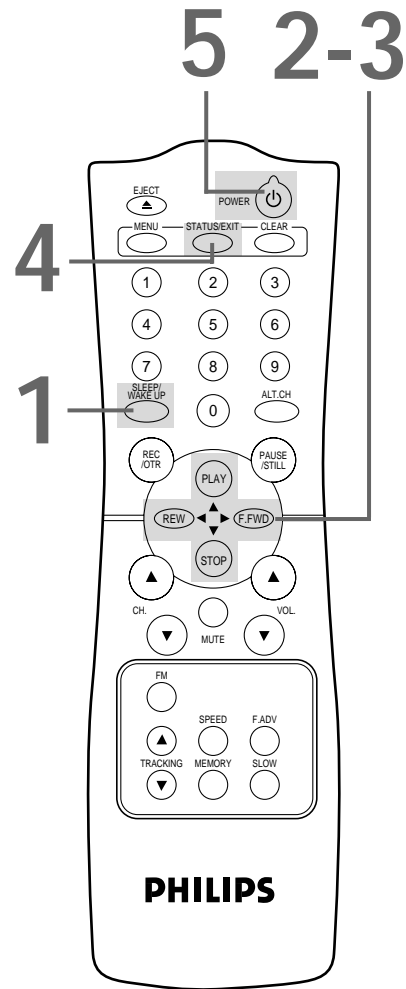

Helpful Hint

- To cancel the Wake Up Timer, press the SLEEP/WAKE UP button. Press the PLAY/▲ button or the STOP/▼ button to select WAKE UP. Then, press the REW(ind)/◀ button or the F.FWD/▶ button to select OFF. Press the STATUS/EXIT button.

Volume Bar 49

Usually, the volume bar appears when you press the VOL(ume) ▲/▼ buttons. If you do not need it, set the VOLUME BAR to OFF. For example, when you watch a program that is being broadcast with closed captions, you may choose to set the VOLUME BAR to OFF so the captions can remain on the screen. The captions will remain on the screen even when you press the VOL(ume) ▲/▼ buttons or the MUTE button.

1

Press the MENU button.

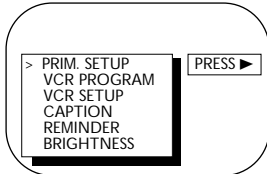

2

Press the PLAY/▲ button or the STOP/▼ button to select PRIM. SETUP. Then, press the F.FWD/► button.

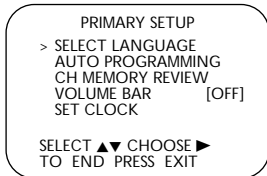

3

Press the PLAY/▲ button or the STOP/▼ button to select VOLUME BAR, then press the F.FWD/► button. Each press of the F.FWD/► button will turn the VOLUME BAR ON or OFF.

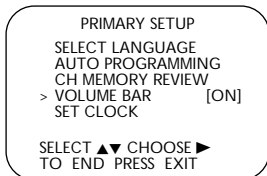

4

Press the STATUS/EXIT button.

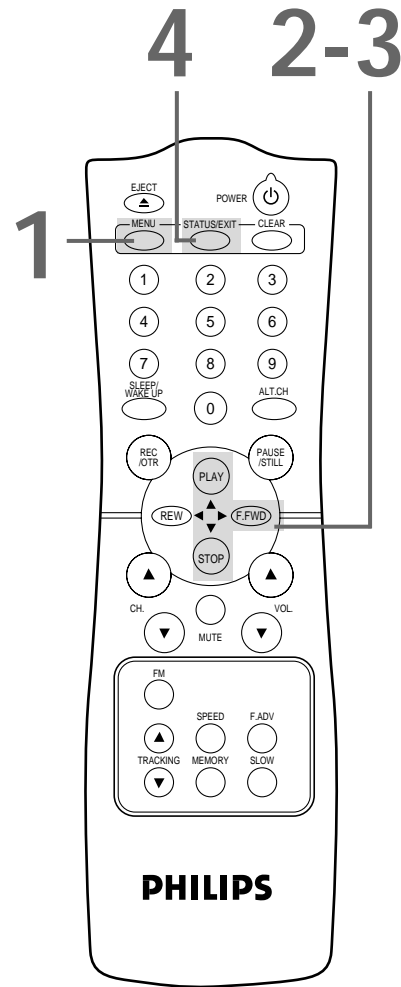

50 Closed Caption

When you watch a program that has closed captions, you can access on-screen boxes containing the program's dialogue (for example, what a character is saying), dialogue in a foreign language, or information (such as a channel guide, schedule, or announcements). Follow the steps below to select closed captions.

Not all TV programs and commercials have closed captions. Similarly, all types of closed captions (second language, half-screen text, etc.) are not always broadcast. If closed captioning is not broadcast, you cannot receive it. This does not indicate a problem with the TV/VCR. Refer to your area's TV program listings for shows with closed captions.

1

Press the **MENU** button.

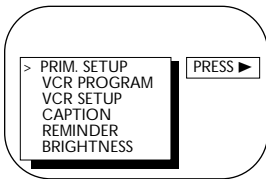

2

Press the **PLAY/▲** button or the **STOP/▼** button to select **CAPTION**.

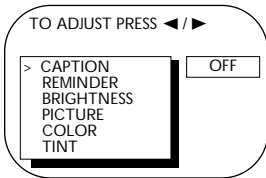

3

Press the **REW(ind)/◀** button or the **F.FWD/▶** button to select your desired closed caption mode.

The selected closed caption mode will appear beside **CAPTION** on the screen.

- **CAPTION1** displays standard closed captions (what a character is saying).
- **CAPTION2** displays foreign language closed captions (foreign language words showing what a character is saying).
- **TEXT1** and **TEXT2** display half-screen text (such as a channel guide, schedule, or announcement).
- **OFF** turns off closed captions. Captions will not appear on the screen.

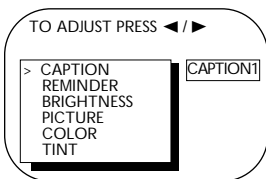

Example:
CAPTION1
Menu
Screen

2-3

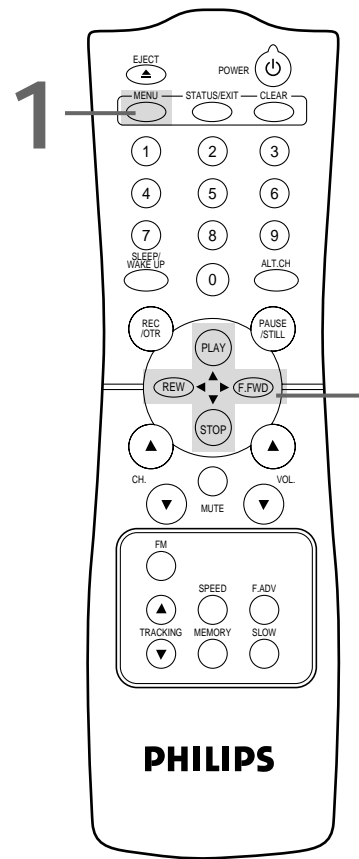

4

Press the **STATUS/EXIT** button. The type of closed captions you selected at step 3 will appear on the screen.

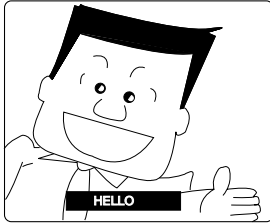

Standard Closed Captions

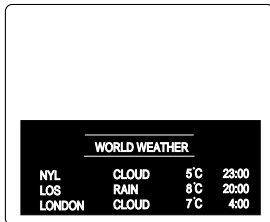

Half-screen text

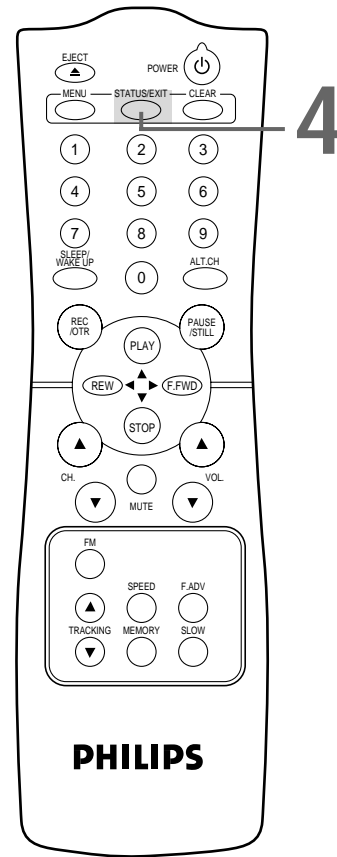

Helpful Hints

- You cannot view closed captions during recording or tape playback if COUNTER ONLY is ON. Details are on page 26.
- Abbreviations, symbols, and other grammatical shortcuts are often used in order to keep pace with the on-screen action. This does not indicate a problem with the TV/VCR.
- To cancel closed captions, follow steps 1-2 on page 50. At step 3, press the REW(ind)/◀ button or the F.FWD/▶ button to select OFF. Press the STATUS/EXIT button.
- When you change channels, the closed captions may be delayed for a few seconds.
- When you adjust the volume or mute the volume, closed captions may be delayed for a few seconds. Details are on page 49.

52 FM Radio

Follow the steps below to listen to FM radio stations through the TV/VCR.

1

Press the FM button to select FM mode. The radio frequency appears on the TV/VCR screen, moving around the screen every few seconds.

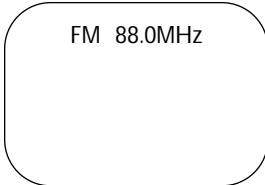

2

Press the CH(annel) ▲/▼ buttons until your desired radio frequency appears. You can choose FM stations within the band range of 88.0 ~ 108.0 MHz. You may get better FM reception by repositioning the TV/VCR.

3

To exit FM mode and return to TV mode, press the FM button again.

Switching the Antennas

If you receive a weak radio signal, you may go to TV mode and switch between the internal (INT) and external (EXT) antennas. When you select the external antenna, make sure your TV antenna or TV cable signal is connected to the ANT(enna) Jack on the TV/VCR. *Details are on page six.*

To switch the antennas, follow these steps.

1

Press the FM button to return to TV mode if necessary.

2

Press the MENU button.

3

Press the PLAY/▲ button or the STOP/▼ button to select FM ANTENNA.

4

Press the REW(ind)/◀ button or the F.FWD/▶ button to select INT or EXT.

5

Press the STATUS/EXIT button.

Choosing FM stations...

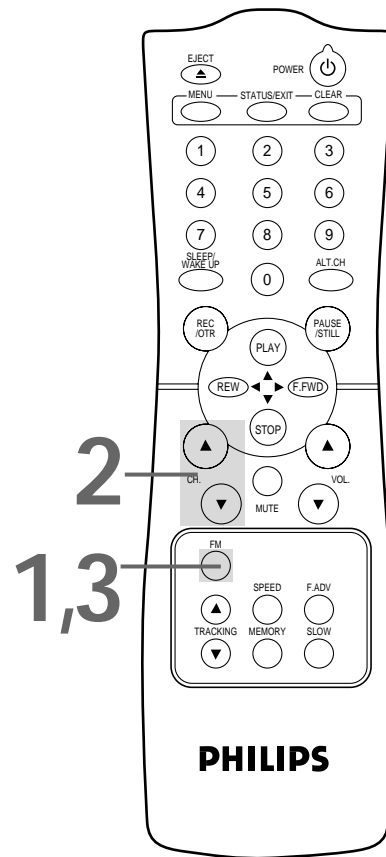

Helpful Hints

- If you turn off the TV/VCR in FM mode, the TV/VCR will be in TV mode when you turn on the TV/VCR again.
- You cannot record the FM station.
- You cannot switch to FM mode during tape playback, although tape playback is allowed while in FM mode.
- You must be in TV mode in order to select Line Input mode (A/V IN).

The following playback features will always operate.

Automatic Playback

When you put a tape in the TV/VCR, the power will come on automatically. If the tape's record tab is missing, playback will begin. If a timer recording is set, the power will not come on automatically when you insert a tape with the record tab intact. If a timer recording is set and the TV/VCR power is off, the TV/VCR will eject the tape if the record tab is missing.

Automatic Rewind, Eject, Off

When you play, fast forward, or record a tape to its end, the TV/VCR will rewind the tape, stop, turn itself off, and eject the tape. If a real-time counter memory is set, the TV/VCR may only rewind the tape to the point at which the real-time counter is set to zero. The TV/VCR will not turn itself off or eject the tape.

Memory Rewind, Power Off

When you press the POWER button while the TV/VCR is rewinding a tape, REW → POWER OFF will appear on the screen. The TV/VCR will turn itself off when the tape has finished rewinding. If a real-time counter memory is set, the TV/VCR may only rewind the tape to the point at which the counter was set to zero, then turn itself off.

Tape Eject

A tape can be ejected with the TV/VCR power on or off (but the TV/VCR must be plugged in). If a timer recording is programmed, a tape can not be ejected when the power is off. Turn on the TV/VCR power, then eject the tape. Be sure to insert a tape and turn off the TV/VCR power for the timer recording.

Automatic Tracking Adjustment

The TV/VCR automatically adjusts the tracking to give you the best possible picture quality. With some recordings, however, you may get a better picture using the manual tracking controls (see below).

Manual Tracking

To adjust the tracking manually, press the CHANNEL ▲/▼ buttons on the TV/VCR or the TRACKING ▲/▼ buttons on the remote control during playback.

Tracking returns to Automatic Tracking Adjustment when you insert a tape or press the STOP/▼ button.

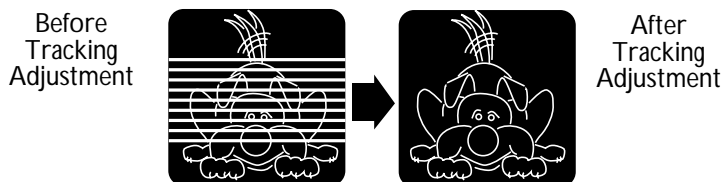

54 Helpful Hints

If you are having problems with your product, check this list of problems and possible solutions before requesting service. You may be able to solve the problem yourself.

If you need to call a customer service representative, please know the model number and serial number of your product before you call. This information is on the back of the product. Also, please take a moment to identify the problem you are having, and be prepared to explain this to the representative. If the representative will need to help you with operations, please stay near the product. Our representatives will be happy to assist you.

Location

For safe operation and satisfactory performance of your TV/VCR, remember the following:

- Shield it from direct sunlight and keep it away from sources of intense heat.
- Avoid dusty or humid places.
- Avoid places with insufficient ventilation. Do not block the ventilation openings at the top and bottom of the TV/VCR. Do not place the TV/VCR on a carpet, as this will block the ventilation openings.
- Avoid locations subject to strong vibrations.
- Do not place the TV/VCR near strong magnetic fields.
- Do not move the TV/VCR from a cold place to a hot place, or vice versa.

Electrical Shock and Fire Hazards

- Do not handle the power cord with wet hands.
- Do not pull the power cord when disconnecting the TV/VCR from the AC (alternating current) wall outlet. Grasp it by the plug.
- If you spill water on the TV/VCR, unplug the power cord immediately and take the TV/VCR to an authorized service center.
- Do not put your fingers or objects into the TV/VCR cassette compartment.
- Do not place anything on top of the TV/VCR.

Dew Warning (Moisture Condensation)

- Moisture may condense inside the unit when you move it from a cold place to a warm place, after heating a cold room, or when the humidity is high. There is no warning that moisture is in your TV/VCR. Playing a tape in a TV/VCR in which moisture has accumulated could damage the tape and the TV/VCR. If you suspect moisture inside the TV/VCR, keep the TV/VCR power on (but do not play a tape) for at least two hours. This will allow the TV/VCR to dry.

TV/VCR will not perform a timer recording.

- Set the recording start and stop times correctly. *Details are on pages 32-35.* Midnight is 12 a.m. Noon is 12 p.m.
- Make sure the TV/VCR power is off.
- Set the clock. *Details are on pages 12-17.*
- Put a tape in the TV/VCR. The tape must have a record tab.
- With ShowGuard, you don't have to worry about losing your timer recordings. If the power fails, timer recordings will be restored when the clock is reset. (The clock will reset itself automatically if you are using AUTO CLOCK. *Details are on pages 14-17.* If you are not using AUTO CLOCK, reset the clock manually. *Details are on pages 12-13.*) The timer recording will not occur only if it was scheduled to take place during the power failure.
- Make sure DEFEAT RECORDING is OFF. *Details are on page 36.*

TV/VCR will not record.

- Make sure the tape has a record tab. *Details are on page five.*
- Make sure DEFEAT RECORDING is OFF. *Details are on page 36.*
- Plug the power cord into an active AC outlet. *Details are on page seven.*
- Check your hookups. *Details are on pages six-seven.*
- Set up the channels. *Details are on page 10.*

Channel reception is poor.

- Check connections, then set up the channels again. *Details are on page 10.*

The remote control is not available, or the remote control will not access the menu.

- Use the buttons on the front of the TV/VCR to access the menu. You can not enter numbers (for example, to program a timer recording) using the front panel buttons. *Details are on page 20.*

TV/VCR has no power.

- Connect the power plug to an AC (alternating current) outlet completely.

TV/VCR power shuts off after 15 minutes.

- To save energy, the TV/VCR will shut itself off after 15 minutes when it is on a channel that is not receiving a broadcast signal (for example, a station that has gone off the air for the night). This is normal.

TV/VCR does not have a picture.

- Adjust the antenna. *Details are on page six.*
- Adjust the TV/VCR picture controls. *Details are on pages 24-25.*
- Select an active channel.

TV/VCR has poor sound or no sound.

- Adjust the volume.
- Press the MUTE button to restore the volume.

Tape playback is poor or tape is destroyed.

- Adjust the tracking. *Details are on page 53.*
- If moisture has accumulated in your TV/VCR, keep the power on for at least two hours, but do not try to play a tape. *Details are on page 54.*

TV/VCR does not display closed captions.

- Make sure COUNTER ONLY is OFF. *Details are on page 26.*
- Make sure closed captioning is available for the program. Refer to the TV listings in your local newspaper.

Remote control does not operate TV/VCR.

- Aim the remote control directly at the TV/VCR's remote sensor. *Details are on pages five and 20.*
- Remove all obstacles between the remote control and the TV/VCR.
- Inspect and replace the batteries in the remote control. *Details are on page five.*

Number buttons will not select channels above 69.

- Enter channel numbers as a two-digit number. If you want to select channels 100 and above, enter channel numbers as a three-digit number. *Details are on page 22.*
- If you are using an antenna, only channels 2-69 will be available. *Details are on pages 10-11.*

You can not insert a tape into the TV/VCR.

- Insert the tape window side up, with the record tab facing you.
- Make sure a tape isn't already in the TV/VCR by pressing the STOP/EJECT button on the TV/VCR.
- Gently push on the center of the tape. Never force a tape into the TV/VCR.
- If you have set a timer recording and the TV/VCR power is off, the TV/VCR will eject the tape if the record tab is missing.

You can not remove the tape from the TV/VCR.

- Make sure the power plug is completely connected to an AC (alternating current) outlet.
- If a timer recording is programmed, turn on the TV/VCR power, then eject the tape. Be sure to insert a tape and turn off the TV/VCR power for the timer recording.
- Unplug the TV/VCR power cord for five minutes. Then, plug in the power cord again, then press the POWER button on the TV/VCR. If the tape does not eject, press the STOP/EJECT button on the TV/VCR three to five times. If the tape still does not eject, you may need to have an authorized servicer remove the tape.

TV/VCR ejects the tape when you try to start a recording.

- Make sure the tape has a record tab. *Details are on page five.*

The cylinder rotates when tape playback is stopped.

- To enable the quick play mechanism, the cylinder will rotate for about five minutes. This is normal. The quick play mechanism switches the tape mechanism from Stop to Play in just one second.

56 Glossary

AUDIO In Jack: jack on the front of the TV/VCR which is used to receive or record audio from another source.

Automatic Channel Setup: process in which the TV/VCR memorizes all available channels. Then, when you push the CH(annel) ▲/▼ buttons, you only scan through channels you receive.

Bands: settings that allow you to tune channels.

- **Antenna** – VHF (very high frequency; channels 2-13) and UHF (ultra high frequency; channels 14-69).
- **Cable** – all standard channels can be received without a Cable Box.

Brightness: adjusting increases or decreases the brightness of the color on the screen.

Color: adjusting pales or brightens the TV/VCR color.

Dubbing: copying a tape using a VCR.

HQ: high quality; a feature in the TV/VCR circuitry which provides enhanced picture detail.

Line Input: The channel to which you set your TV/VCR during dubbing or when you want to watch material from other equipment that is connected to the TV/VCR. The line input channel is always channel 00 (A/V IN).

Mode: a TV/VCR operation.

OTR: One-Touch Recording; a timed recording that starts immediately and records for 30 minutes to eight hours, whichever you specify.

Picture: adjusting increases or decreases the contrast of the picture on the screen.

Sharpness: adjusting softens or clarifies the picture on the screen.

Tape Speeds: how fast the tape travels during playback or recording.

- **SP** (standard play) – fastest tape speed (recording time for a T120 tape is approximately two hours); best picture quality.
- **LP** (long play) – average tape speed; playback only.
- **SLP** (super long play) – slowest tape speed (recording time for a T120 tape is approximately six hours).

Tint: adjusting changes the tints of the picture on the TV/VCR from purple to green.

VIDEO In Jack: jack on the front of the TV/VCR which is used to receive or record video from another source.

General

CRT: 13-inch in line gun (CCC133)
19-inch in line gun (CCC193)
Television system: NTSC-M
Closed caption system: Section 15.119, FCC
(Federal Communications Commission) Standard
Video Heads: Four heads
Tape width: 1/2 inch (12.65 mm)
Tape speed
SP: 33.35 mm/sec.
LP: 16.67 mm/sec.
SLP: 11.12 mm/sec.
Operating Temperature: 41°F (5°C) to 104°F (40°C)
Relative Humidity: 10% to 75%
Power requirement: AC 120V, 60Hz
Power consumption: 65W (CCC133)
90W (CCC193)

Sound output: 1W

Dimensions:

15-3/4" (H) x 15-3/16" (W) x 14-13/16" (D)  (CCC133)

400mm x 386mm x 377mm

19-5/8" (H) x 19-3/8" (W) x 18-11/16" (D)  (CCC193)

498mm x 492mm x 474mm

Weight: 24.3 lbs (11.0 kg) (CCC133)

Weight: 44.1 lbs (20.0 kg) (CCC193)

Tuner Broadcast Channels

VHF 2-13, UHF 14-69

Cable TV Channels

1-125

FM Radio Channels

88.0-108.0MHz

Terminals

Antenna In: VHF/UHF 75 ohms unbalanced

Video In: RCA connector

Audio In: RCA connector

Earphone: 3.5 mm CES

Electrical Specifications

Video input level: 0.5~2.0Vp-p

Audio input level: -10dBv

Video S/N ratio

SP: More than 42dBμ

Audio S/N ratio

SP: More than 38dB

Designs and specifications are subject to change without notice and without our legal obligation.

**RENEWED
90 DAY
LIMITED WARRANTY**

<ul style="list-style-type: none"> a-b repeat play 38-39 accessories 60 ant(enna) jack 6, 21 audio in jack 7, 20, 31 automatic <ul style="list-style-type: none"> playback 53 rewind 53 batteries 5 blue background 46 brightness, adjusting 24-25 channel <ul style="list-style-type: none"> above 100 22 adding 11 buttons 20, 53 deleting 11 reviewing 11 setup 10 ch(annel) ▲/▼ buttons 23 clear button 22 clock 12-17 closed caption system 50-51 color, adjusting 24-25 connections 6-7, 31 contents, table of 4 controls <ul style="list-style-type: none"> remote 22-23 tv/vcr 20 counter only mode 26 daylight-savings time 18 defeat recording 36 duplication 31 earphone jack 20 eject button 22 ejecting a tape 55 f.adv button 23, 41 fast forward search 41 f.fwd/▶ button 22, 41 f.fwd button 20 fm button 23, 52 fm radio 52 front panel 20 glossary 56 helpful hints 54-55 hookups 6-7, 31 language selection 9 line input mode 7, 10, 31, 56 	<ul style="list-style-type: none"> long play 29, 56 lp 29, 56 memory <ul style="list-style-type: none"> button 23, 39-40 real-time counter 40 rewind, power off 53 menu <ul style="list-style-type: none"> button 23 front panel button access 20 mute button 22 number buttons 22 one-touch recording 30 pause/still button 23, 41 picture, adjusting 24-25 play button 20, 22 playback options 41 playing 28 power <ul style="list-style-type: none"> button 20, 22 cord 7, 21 real-time counter memory 40 rear panel 21 rec/otr button 20, 23 record light 20 recording 29 recording prevention 5 reminder 27 remote <ul style="list-style-type: none"> control <ul style="list-style-type: none"> buttons 22-23 using 5 sensor 20 repeat play 37 rerecording 31 rew(ind) button 20 rew(ind)/◀ button 23, 41 rewinding 41 safety precautions 3 searching 41 sensor (remote) 20 sharpness, adjusting 24-25 showguard 32, 35, 54 sleep timer 47 slow <ul style="list-style-type: none"> button 23 motion playback 41 slp 29, 56 smartclock 14-17 	<ul style="list-style-type: none"> smartlock 42-45 sp 29, 56 specifications 57 sqpb 28 standard play 29, 56 status display 26 status/exit button 23, 26 still picture 41 stop/▼ button 23 stop/eject button 20 super high speed searching 41 super long play 29, 56 table of contents 4 tape <ul style="list-style-type: none"> duplication 31 speed 29, 56 time <ul style="list-style-type: none"> setting 12-17 zone 19 timer recording <ul style="list-style-type: none"> cancelling 35 reviewing 35 setting 32-34 tint, adjusting 24-25 tracking 53 video in jack 7, 20, 31 volume bar 49 wake up timer 48 warranty 58
---	---	--

SUPPLIED ACCESSORIES

The following items are supplied with your TV/VCR; they are provided to help you use or set up your TV/VCR.

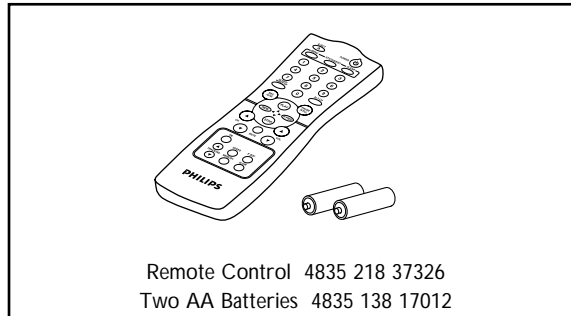

OPTIONAL ACCESSORIES

The following additional items are not provided with your TV/VCR, but they are designed for use with your new TV/VCR. To order these optional accessories, contact us at:

**Philips Parts & Accessories Marketing Department
401 East Old Andrew Johnson Highway
P.O. Box 555
Jefferson City, TN 37760
1-800-851-8885.**

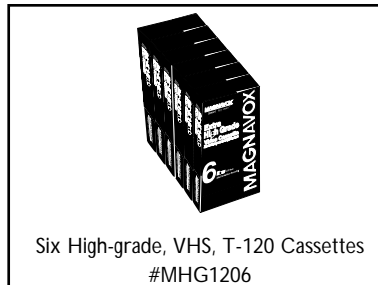
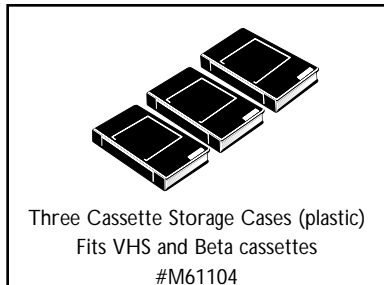
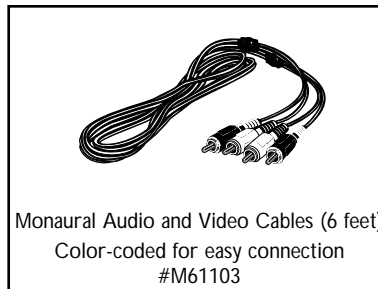

This owner's manual is made of recycled paper.



As an ENERGY STAR® Partner, Philips Consumer Electronics has determined that this product meets the ENERGY STAR® guidelines for energy efficiency. ENERGY STAR® is a U.S. registered mark.

IB8303E001
Printed in Malaysia
OEMN01820 / T5218UU * * * * *