

PENTAX®

OPERATING MANUAL

IQZ_{oom}105S

IQZ_{oom}105S_{DATE}

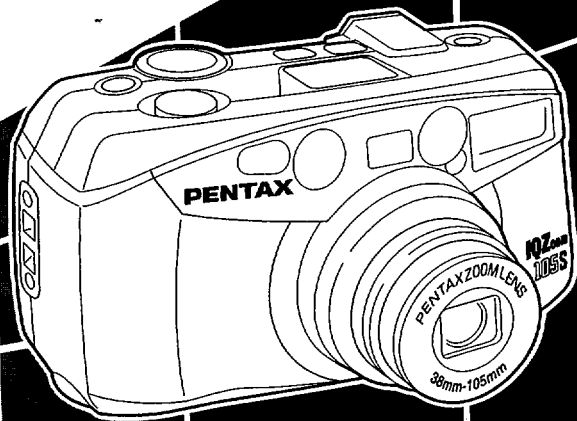

Congratulations on your purchase of the PENTAX IQ Zoom 105S and welcome to the world of Pentax zoom compact photography!

- Please read this manual carefully before operating the camera to take consistently superior pictures.
- Pay special attention to the cautions and notes in this Operating Manual. Pictures and illustrations shown herein may differ from the camera's actual appearance.
- Illustrations in this operating manual are the DATA MODEL.

Icon indications used in this manual







Operation direction	
Automatic operation	
Attention	
Lamp lighted	
Lamp blinking	
Correct	
Incorrect	

TABLE OF CONTENTS

Names of working parts	2
LCD panel	3
For safe use of your camera	4
Precautions for your camera	5
Precautions for battery usage	6

PREPARATIONS BEFORE TAKING PHOTOGRAPHS

Strap attachment	7
Installing/Replacing battery	8
Battery exhaustion warning	8
Main switch	9
Diopter adjustment	9
Holding the camera	10
Operating 38-105mm zoom lens	11

TAKING PHOTOGRAPHS

Film loading	12
Viewfinder displays	15
Lamp indications	15
Taking pictures	16
Hard-To-Autofocus Subjects	17
Focus-lock shooting	18
Unloading film	19

TAKING BETTER PHOTOGRAPHS

How to select the Exposure Modes, AF and Drive Modes	21
Daylight-sync shooting	22
Taking pictures at a slow shutter speed	
• Slow Shutter Speed (Flash-OFF)	23
• Slow-Speed-Sync Shooting (Flash-ON)	23
• Bulb shooting	24
• Bulb-sync shooting	24
Self-timer photography	25
Infinity-landscape shooting	26
Date Model	26
Troubleshooting	28
Specifications	30
Warranty policy	32

NAMES OF WORKING PARTS

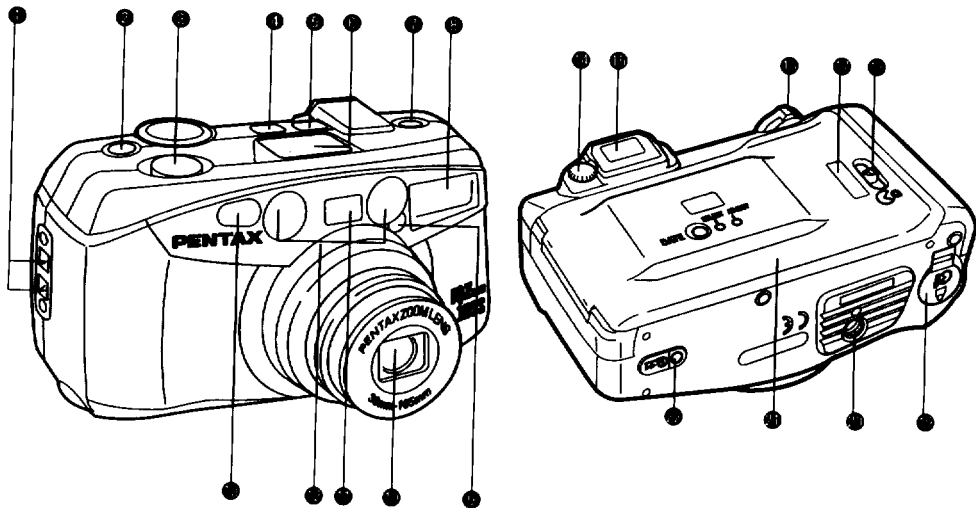

LCD PANEL

- ① Strap lug (p.7)
- ② Main switch (p.9)
- ③ Shutter release button (p.10)
- ④ AF/infinity-landscape
/ Drive button (p.21)
- ⑤ Mode button (p.21)
- ⑥ LCD panel
- ⑦ Red-eye reduction lamp button (p.21)
- ⑧ Built-in flash
- ⑨ Self-timer lamp (p.21, 25)
- ⑩ Lens
- ⑪ Viewfinder window
- ⑫ Autofocus window
- ⑬ Light sensor window
- ⑭ Diopter adjustment dial (p.9)
- ⑮ Viewfinder eyepiece
- ⑯ Zoom lever (p.11)
- ⑰ Film information window
- ⑱ Back cover release lever (p.12)
- ⑲ Battery chamber cover (p.8)
- ⑳ Tripod socket
- ㉑ Back cover
- ㉒ Mid-roll rewind button (p.20)

All indications will not actually appear simultaneously as shown.

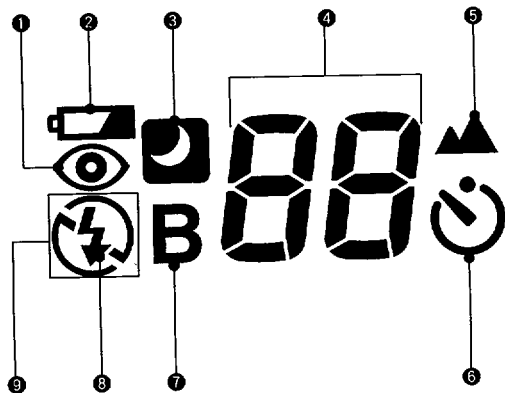

- ① Red-eye reduction flash mode (p.21)
- ② Battery exhaustion warning (p.8)
- ③ Slow-Speed Shutter (p.23)
- ④ Exposure counter (p.14)
- ⑤ Infinity-Landscape Mode (p.26)
- ⑥ Self-timer (p.25)
- ⑦ Bulb (p.24)
- ⑧ Flash on (p.22,23,24)
- ⑨ Flash off (p.23,24)

FOR SAFE USE OF YOUR CAMERA

Although we have carefully designed this camera for safe operation, please be sure to follow precautions given in this page.



WARNING

This mark indicates precautions that if not followed, could result in serious injury to the operator.



CAUTION

This mark indicates precautions that if not followed, could result in minor or medium injury to the operator or damage to the equipment.



WARNING

- The electric circuits inside the camera contain high voltage working parts. Never attempt to disassemble the camera yourself.
- Never touch internal parts of the camera if they become exposed from dropping the camera or for some other reason, as there is danger of electric shock.
- Be sure to store batteries out of the reach of children. Seek medical assistance immediately if accidentally swallowed.



CAUTION

- Do not use the flash near anyone's eyes, as it may hurt them. Be particularly careful with the flash around infants.
- Never try to disassemble, short or recharge the battery. Also, do not dispose of the battery in fire, as it may explode.
- Remove the battery from the camera immediately if it becomes hot or begin to smoke. Be careful not to burn yourself during removal.

PRECAUTIONS FOR YOUR CAMERA

Precautions when taking pictures

- Do not use the camera where it may come in contact with rain, water or any other liquid, because the camera is not weather, water, or liquid resistant. Should the camera get wet from rain, splashing water, or any other liquid, wipe it off immediately with a dry soft cloth.
- Do not drop the camera or allow it to hit a solid object. If the camera suffers a severe shock or impact, take it to a Pentax service center for inspection.
- Be careful not to subject the camera to strong vibrations, shock or pressure. Use a cushion to protect the camera when carrying it in a motorcycle, car, boat, etc.
- Condensation on the interior or the exterior of the camera may be extremely harmful to the camera mechanism as it may cause rust. Furthermore, if the camera is taken from warm temperature to a subfreezing one or vice versa, the formation of icelets may cause damage. In such a case, put the camera into a case or plastic bag so that any changes in temperature difference is minimized. Do not remove it from the bag until temperature has stabilized.

Precautions for proper care

- Use a blower and lens brush to remove dust accumulated on the lens or the viewfinder window.
- Never use solvents such as paint thinner, alcohol or benzene to clean the camera. To clean the external camera surfaces, - but not glass surfaces; using a dry or silicone-treated cloth is recommended.
- The electric circuits inside the camera contain high voltage working parts. Never attempt to disassemble the camera yourself.

Precautions for storage

- Avoid leaving the camera for extended periods in places where temperature and humidity are high such as in a car.
- Do not store the camera in a closet with mothballs or in a case where chemicals are handled. Store it in a place with good air circulation to prevent fungus growth.

PRECAUTIONS FOR BATTERY USAGE

Other precautions

- The temperature range at which this camera functions properly is 50°C to - 10 °C (122 °F to 14 °F).
- To maintain optimum performance, it is recommended that the camera be inspected every one or two years. If the camera has not been used for an extended period, or is being prepared for an important photographic session, it is recommended that you have the camera inspected or test shoot with it.
- The PENTAX warranty provided only for the repair of defects in materials or workmanship. Damage of any kind cannot be repaired at no charge under the term of the warranty. If the difficulty is caused as a direct result of the product being used in conditions as out lined in the other operation contrary to the instructions outlined in this manual, charges will be assessed or a repair quotation will be provided.
- Misuse of a battery can cause hazards such as leakage, overheating, explosions, etc. The battery should be inserted with the "+" and "-" sides facing correctly.
- Never try to disassemble, short or recharge the battery. Also do not dispose of the battery in a fire, as it may explode.
- Battery performance may be temporarily hindered in low temperatures, but will recover in normal temperatures.
- Keep a spare battery on hand for replacement convenience when shooting outdoors or while traveling.
- Be sure to store the battery out of the reach of children. Seek medical assistance immediately if accidentally swallowed.
- When the camera is in a bag, make sure the main switch is off; otherwise, battery power may be wasted if the shutter release button is accidentally pushed.



STRAP ATTACHMENT

PREPARATIONS BEFORE TAKING PHOTOGRAPHS

Fit the strap on the camera as illustrated.

- Use the illustrated part of the strap for opening the battery chamber cover, adjusting the data on the Date model, or pushing the mid-roll rewind button.

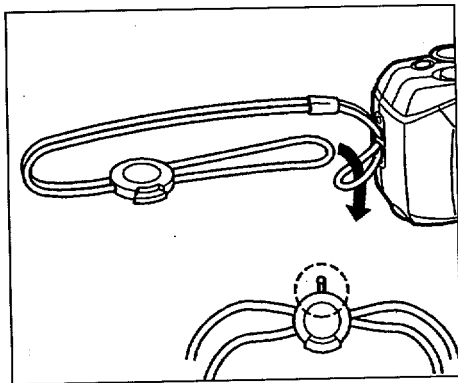

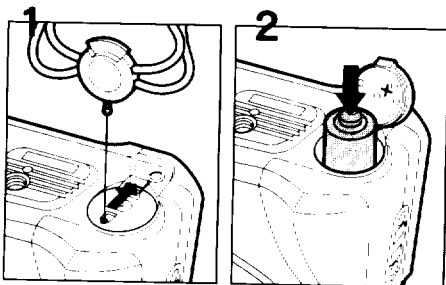

Ensure that the power is off before replacing the battery.

1. Open the battery chamber cover by using the strap clamp's protrusion.
 2. Insert one lithium battery with the plus/minus (+/-) sides matching the indications in the battery compartment.
 3. Close the battery chamber cover. Ensure that the cover is locked with a click.
- If the battery is correctly loaded, the zoom lens moves slightly and the motor operates for a few second.
 - On the DATE MODEL, the data is initialized when the battery chamber cover is opened.

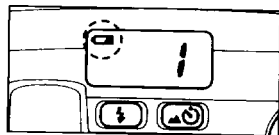

Battery exhaustion warning

When the battery is nearly exhausted, the battery symbol (⎓) appears on the LCD panel to warn you. Replace the battery as soon as possible. When (⎓) starts blinking, no operations can be performed.

Battery life (using 24-exposure film rolls):

Approx. 15 rolls using flash 50% of the time (using the CR123A battery and under Pentax testing conditions). Actual battery life/performance may vary drastically depending on usage of Power Zoom, Flash and external conditions such as temperature and freshness of the battery.

Notes on replacing the battery:

After opening the battery chamber cover, correct the time and date. See page 26

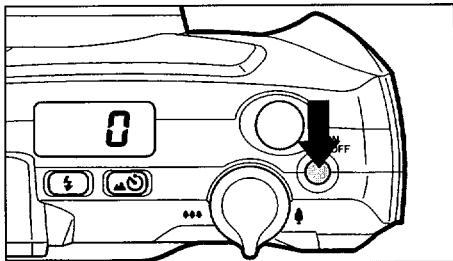
3**MAIN SWITCH**

When the main switch button is depressed, the power turns ON. When the power turns ON, the lens extends slightly for opening the lens cover.

- When not in use, ensure that the camera is switched off.
- If the camera is ON and left unused for over 3 minutes, the lens automatically retracts.

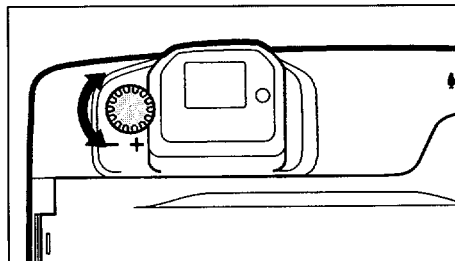
4**DIOPTER ADJUSTMENT**

Aim the camera toward a bright subject. While looking through the viewfinder, rotate the diopter adjustment dial to the right or left until the AF frame appears in the sharpest focus.

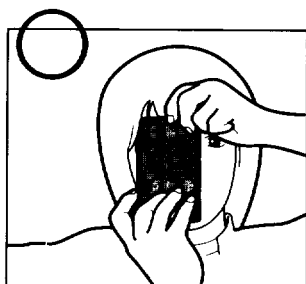
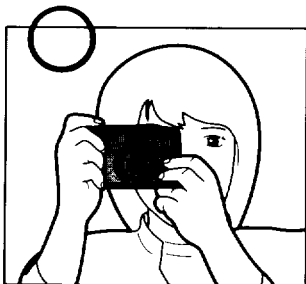

Keep the camera as still as possible steadying it against your face.

Depress the shutter release button gently. (If too much force is applied, the camera is likely to shake, and the picture will be blurred.)

Try to brace your elbows against a stable, stationary object such as a wall.

Do not obstruct the autofocus window, lens, light sensor window or the built-in flash with your fingers, hair or other object.

Notes:

- Do not hold the zoom lens because it moves back and forth while in operation.
- When using the flash with the camera positioned vertically, hold the camera so that the flash is above the lens.

6

OPERATING 38-105mm ZOOM LENS

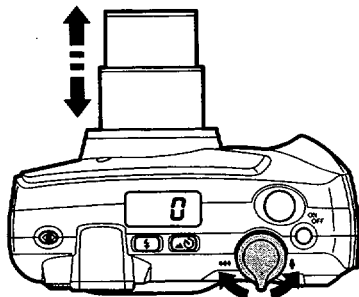
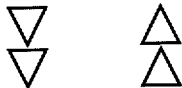

When you move the zoom lever to the right (◆), the lens moves towards the 105mm telephoto setting and frames the subject more closely. When you move the zoom lever to the left (◆◆◆), the lens moves towards the 38mm wide angle setting.

Notes:

- The shutter cannot be released while the lens is zooming.
- Do not apply force to the zoom lens as doing so causes damage to the camera.



FILM LOADING

TAKING PHOTOGRAPHS

After reading this instruction manual you should be familiar with the functions available on the camera, and you're ready to insert the film.

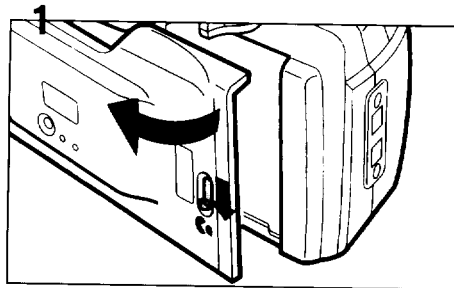

1. Open the back cover as illustrated.

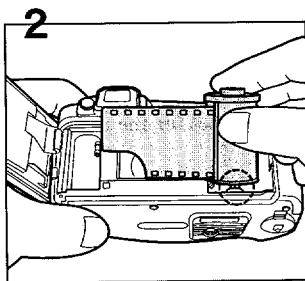

2. Place the film cartridge in the film chamber by fitting its flat side on the top of the rewind shaft first and then slide the top end of the film cartridge into the camera.

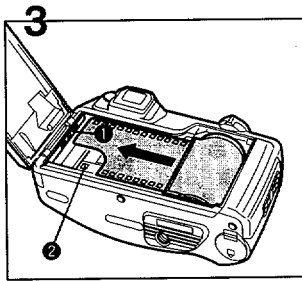

3. Pull the film leader out far enough from the cartridge to reach the take-up spool. Align the tip of the film with the film leader end mark ①

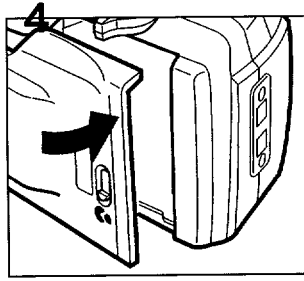

4. Close the back cover. The film automatically advances to the first frame.

Notes:

- If there is dirt on the film detector ②, the film cannot be wound properly.
- Ensure the film is taut as illustrated on the illustration below. Take up any slack in the film by pushing it back into the cartridge.
- If the end of the film leader is extremely bent, straighten it or cut off the bent portion.

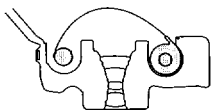

×Slack No !

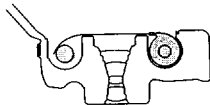

○Flat Yes !

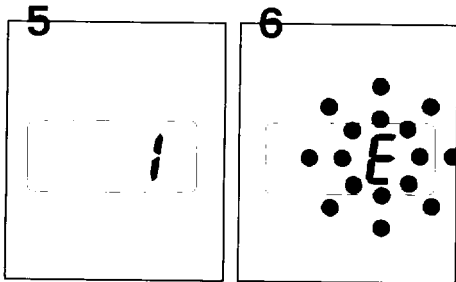

5. When (|) appears in the exposure counter on the LCD panel, the film automatically stops winding.

6. If (E) blinks on the LCD panel, it means the film is not properly loaded. Reload the film.

- The exposure counter indication will remain on even if the main switch is turned off.

Film and Film Speed Setting

- This camera is designed to use DX-coded films with ISO rating from 25 to 3200. When any of these films are loaded, the proper film speed is automatically set for the camera.

Notes:

- Non-DX coded film cannot be used. If non-DX coded film is used, the camera automatically set the film speed to ISO 25.
- A film with ISO 400 film speed is recommended to get less image blur and to cover more photographic situations.



VIEWFINDER DISPLAYS AND LAMP INDICATIONS

VIEWFINDER DISPLAYS

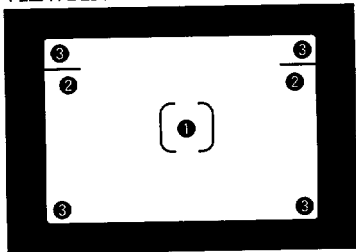

1 Autofocus frame

Focus on the subject with this frame.

2 Close distance compensation frame

When the camera-to-subject distance is less than 1m, compose the scene within this frame.

3 Picture area

When taking a normal picture, compose the scene within this frame.

Lamp indications

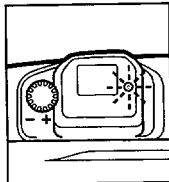

Lamp ON:

Depress the main switch button. When you depress the shutter release button halfway down, the green lamp lights up or blinks.

When the subject is in focus, it will light up to indicate that you can take picture.

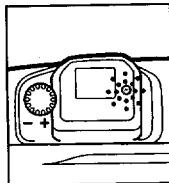

Blinking:

If either the camera-to-subject distance is less than 0.65m (2.1 ft) or the flash is being charged, the green lamp blinks and you cannot release the shutter.

Shooting range:

0.65m (2.1ft) to infinity

- While the lamp is blinking, you cannot release the shutter.
- Ensure that the lamp is lit continuously before taking pictures.
- When the flash is being charged, () on the LCD panel also blinks.

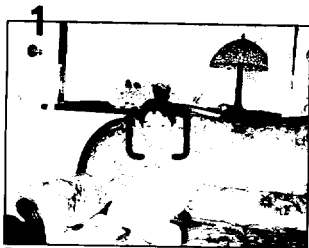

Turn the power on by depressing the main switch button.

1. Composing the scene

After zooming the lens and composing your scene, focus on the subject with autofocus frame.

- When the main subject is off the autofocus frame in the center of the viewfinder, use the focus-lock technique. See page 18.

2. Checking the lamp indication

Depress the shutter release button halfway down. When the subject is in focus, the green lamp will light up.

- The green lamp blinks if the subject is too close or the flash is being charged.

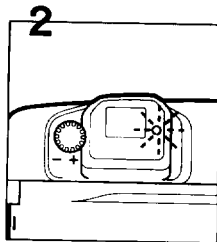

Lamp on

- The lamp blinks one of the following reasons.

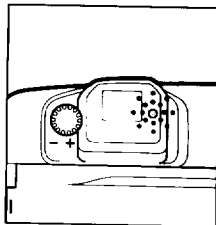

Blinking

- The subject is too close. Extend the camera-to-subject distance until the green lamp is lit continuously.
- The flash is being charged. Lift your finger from the shutter release button for a few seconds until the flash is fully charged.
- If you wish to focus on another subject, lift your finger from the shutter release button, recompose and then depress the shutter button halfway down again.
- If the autofocus window is dirty, the autofocus may not function properly.

3. Shooting

Depress the shutter release button fully, and the shutter will be released. The film automatically advances to the next frame.

- When the shutter is released, the self-timer lamp lights up to indicate that a picture has been taken.

Automatic Flash Emission

The flash automatically discharges in low light or in a backlit condition. When the shutter release button is pressed halfway down, the red lamp lights up indicating that the flash is ready. If the red lamp blinks, the built-in flash is being charged and the shutter cannot be released.

Flash effective ranges (Negative color film is used)

Lens \ ISO	100	200	400
38 mm (◆◆◆)	0.65 - 4.1m (2.15-13ft)	0.65 - 5.8m (2.15-19ft)	0.65 - 8.2m (2.15-27ft)
105 mm (◆)	0.65 - 1.7m (2.15-5.6ft)	0.65 - 2.4m (2.15-7.9ft)	0.65 - 3.3m (2.15-11ft)

HARD-TO-AUTOFOCUS-SUBJECTS

The autofocus system is highly precise, but not perfect. Some subjects may not focus as you wish. In this case, use the focus-lock technique on another subject near the actual one and equidistant from the lens. Subjects which may fool the autofocus system include:

- a) Black or very dark objects, which don't reflect much light.
- b) Subjects with horizontal lines, complex or detailed patterns.
- c) Flickering light sources such as neon signs, fluorescent lamps, TV images, sunlight coming through trees, etc. and subjects illuminated by these light sources.
- d) Glossy and reflective surface like glass, mirror, car bodies, etc.
- e) Fast moving subjects.
- f) Water jets, water surface, smoke, flame, fireworks, etc. which have no distinct or consistent form, or a subject in mist.



FOCUS-LOCK SHOOTING

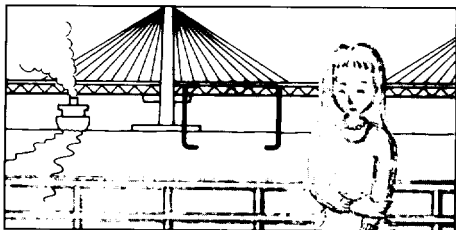

If you shoot without positioning the autofocus frame (□) on the main subject, only the background will be in focus. When the main subject is off the autofocus frame in the center of the viewfinder, use the focus-lock technique. (Focus lock is the function to lock focus.)

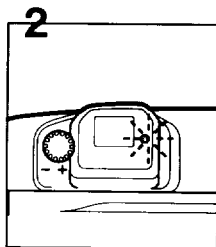
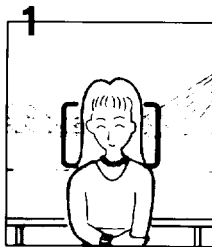

- 1 Focus on the subject with the autofocus frame (□).**
- 2 When the shutter release button is depressed halfway down, the green lamp in the viewfinder lights up and the exposure and focus are temporarily locked.**



UNLOADING FILM

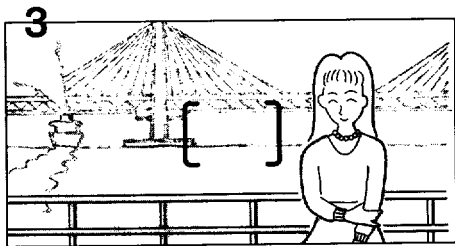

3 While depressing the shutter release button halfway, re-aim the camera or re-compose the picture, then release the shutter.

Note:

- You can release focus lock simply by lifting your finger from the shutter release button.

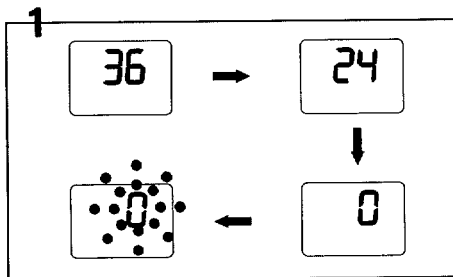

1 Rewinding the film

After you have exposed the last frame of the roll, the lens retracts and the film rewinds automatically. Then, the motor stops, and (0) blinks as shown to indicate that the film has been rewound.

- (0) blinks for approx. 5 sec. after the whole film is rewound.
- Remove the film from the camera in the shade or by using your body to shade the camera
- A 24-exposure roll of film takes about 20 seconds to be rewound.

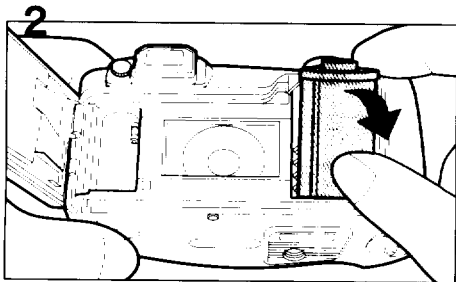

2 Unloading film

Open the back cover, and remove the cartridge from the chamber by pulling the top out first with your finger.

Notes:

- Never open the back cover until the whole film is rewound.
- The shutter may be released one or two frames even after the specified number of frames have been used up as indicated on the film cartridge. If this occurs, these extra frames may be lost in processing.

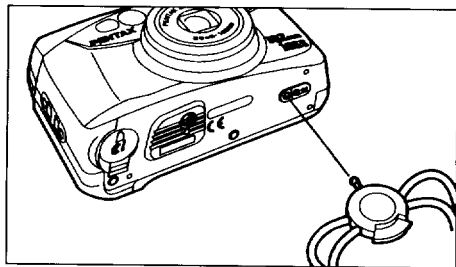

Rewinding a film in mid-roll

If you wish to unload a film before exposing all the frames, push the mid-roll rewind button with the protrusion part of the strap clamp.

- The lens retracts and then film rewinding starts.
- When rewind is completed, the motor stops, and () blinks, indicating that the back cover may be opened safely.

TAKING BETTER PHOTOGRAPHS HOW TO SELECT EXPOSURE, AF AND DRIVE MODES

Turn the power on by depressing the main switch button.
To set various exposure modes, depress mode button ①.

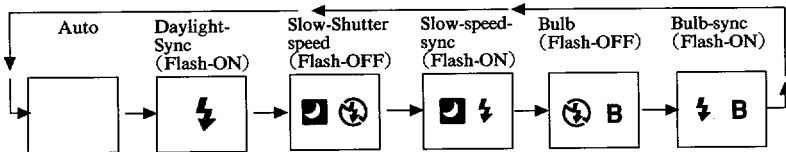

- For normal use, set the Auto Mode.

To set various shooting modes, depress the AF/infinity-landscape/Drive button ②.

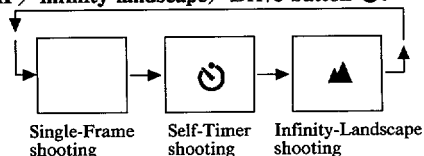

- For normal use, use the Single-Frame Shooting Mode.

Red-Eye Reduction Flash Function

To reduce the red-eye phenomenon in the picture, depress the red-eye reduction lamp button (Ⓞ). With this mode, the self-timer lamp lights up for approx. 1 second just before the flash is discharged to reduce the appearance of the red-eye effect. To cancel this mode, depress the red-eye reduction button again.

DAYLIGHT-SYNC SHOOTING

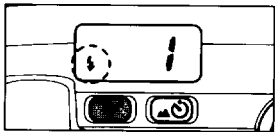

Depress the mode button until (⚡) appears on the LCD panel.

In this mode, the flash will discharge in both dark and bright conditions. When a portrait is taken with the subject in a backlight situation, the front of the subject may be cast in shadow. In such a case, use the Daylight-Sync Shooting Mode (Flash-ON mode) within the flash-effective range to take pictures. This will ensure that a picture is well exposed without any shadow. When you wish to use the flash, use this mode and the flash will always discharge.

Note:

- Make sure you're within the flash effective range even when you use the built-in flash as a fill-in flash in daylight.



Without Daylight-Sync



With Daylight-Sync

TAKING PICTURES AT A SLOW SHUTTER SPEED

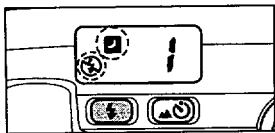

Slow Shutter Speed (Flash-OFF)

Depress the mode button to set the mode until (⚡❏) appears on the LCD panel.

In this mode, the flash does not discharge, and a picture is taken at a slow shutter speed up to approx. 1/3 seconds. Use it in places where flash photography is prohibited, such as in theaters and museums. Furthermore, this mode is also useful for a natural existing light effect in low ambient photography.

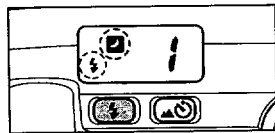

Slow-Speed-Sync Shooting (Flash-On)

Depress the mode button until (⚡❏) appear on the LCD panel.

It is possible to photograph subjects and background in a balanced way (as shown in the photo) by using the flash to properly expose the foreground subject and a slow-speed to expose the low light background.

Notes:

- When shooting in low light, the shutter speed gets slower, and camera shake is likely to blur your picture. Use of a tripod is recommended.
- Make sure you are within the flash effective range even when you use the flash as a fill-in flash in daylight. See page 17 or 29.

BULB, BULB-SYNCHRO SHOOTING



Bulb Mode (⊕B)

This mode is useful for long exposures required for shooting fireworks and night scenes, for example. When using this mode, the camera should be mounted on a tripod so that the camera will be steady.

Depress the mode button until (⊕B) appears on the LCD panel.

Note:

The camera should be mounted on a tripod so that the camera will be steady.

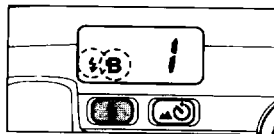

Bulb-Synch Mode (⚡B)

This lets you use the flash in addition to the Bulb Mode, so you can take a portrait photograph with a night scene in the background, for example.

Depress the mode button until (⚡B) appears on the LCD panel.

Notes:

- Make sure you're within the flash effective range even when the Bulb-Sync Mode in use. See page 17 or 29.
- Use of a tripod is recommended.

SELF-TIMER PHOTOGRAPHY

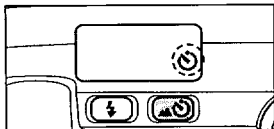

Self-timer

Use the self-timer if you wish to get in the picture. Use of a tripod is recommended.

To use

Depress the AF/infinity-landscape/Drive button until (⊙) appears on the LCD panel.

Assure that the subject is within the AF frame in the viewfinder. Depress the shutter release button fully.

- The shutter will be released in about 10 seconds. When the Self-Timer is working, the Self-Timer symbol (⊙) blinks on the LCD panel, and the Self-Timer lamp lights up. The lamp starts blinking 3 seconds before the shutter is released.

To cancel

To cancel the self-timer at any time after it's been activated, depress the main switch button.

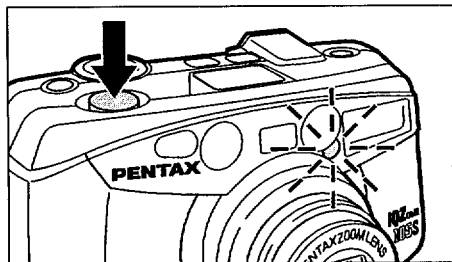

Notes on the self-timer shooting

- Use of a tripod is recommended.
- If you are standing directly in front of the camera when starting the Self-Timer, the camera will be focused in you, not the main subjects. Be sure that you are behind, or next to the camera when starting the Self-Timer.
- When you want to use the flash with the self-timer, ensure that the red lamp is lit indicating the flash has been charged before operating the self-timer.

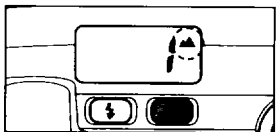

When you wish to take a sharp picture of a distant landscape or a distant subject through a window, the Infinity-Landscape Mode allows you to capture distant scenery with clarity.

Depress the AF/infinity-landscape / Drive button until (▲) appears on the LCD panel.

- After the picture is taken by fully depressing the shutter release button, this mode is canceled.
- In this mode, the flash will not discharge.

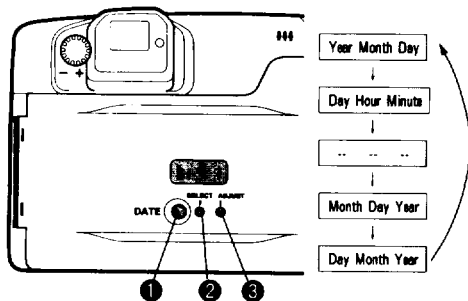

If you purchased the DATE model, read this section.

Notes:

- The data on the LCD panel will be imprinted on the film.
- "----" indicates no data will be imprinted.
- The DATE model records dates up to the year 2049 on pictures.
- Year 2001 will be imprinted 01 on the pictures.

Switching the Mode

Press the MODE button ① with your finger, the mode on the LCD panel switches as shown in the chart.

Correcting the date

Use the strap clamp's protrusion to depress the SELECT and ADJUST buttons.

1. To select the category of digits that you want to change, depress the SELECT button ② repeatedly until the digits on the LCD panel that you want to change begin to blink.
 2. Depress the ADJUST button ③ to change digits of the specified category you chose with the SELECT button ②. Digits increase by one each time you depress the ADJUST button ③. Holding down the button will advance digits continuously.
 3. After the data has been adjusted, depress the SELECT button ② until blinking stops. The bar mark (-) appears on the LCD panel, indicating that data imprinting choices are possible.
- The blinking ":" allows precise fine-tuning of the internal clock to the beginning of a specified minute. To do so, depress the mode button ① until "Day-Hour-Minute" digits appear and then depress the SELECT button ② to make the ":" blink. Then depress the adjust button ③ in sync with a time signal.

- If you release the shutter while the blinking data is being corrected, the data cannot be imprinted.

Operational precautions

- As you release the shutter, the bar (-) mark on the display blinks for a few seconds, indicating the data has been imprinted.
- If there is a white or yellow object in the corner of the picture where the data is imprinted, the data may be difficult to read. When composing your photographs, try to avoid brightly-colored subjects in that corner.

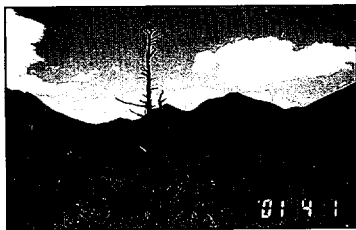

- * The date in the picture above is simulated.

TROUBLESHOOTING

What appears troublesome may be easily remedied. Here are some problems that may occur and their remedies.

Symptoms	Causes and Remedies
1. The shutter cannot be released.	<ul style="list-style-type: none">• Is the main switch turned off? If so, turn it on. See page 9.• Is the battery exhausted? Replace it or insert new battery if it is exhausted. See page 8.• Is (D) blinking on the LCD panel? If so, the film has been used up. Insert a new roll. See page 12.
2. My printed pictures don't look very clear.	<ul style="list-style-type: none">• Did you position the autofocus frame on your subject? See page 16.• Did you obstruct the autofocus window with your fingers, hair or other object when you depress the shutter release button? See page 10.• Is the autofocus window dirty? Wipe it off. See page 16.
3. Zoom lens retracted automatically (the power is turned off automatically)	<ul style="list-style-type: none">• Did you leave the camera unused for over 3 minutes after the main switch was turned on? The power is automatically switched off if the camera is left unused for over 3 minutes. See page 9.

Symptoms	Causes and Remedies
4. The flash discharges, though it is not dark.	<ul style="list-style-type: none"> Daylight sync mode has been set. See page 22.
5. The (H) or (U) mark is displayed on the LCD panel.	<ul style="list-style-type: none"> If either mark disappears when the zoom lever is moved, the camera is ready for use. The camera may be defective if either mark appears often.

Flash effective ranges other than ISO 100, 200 or 400 (Nega-color film used)

ISO Lens	25	50	800	1600	3200
38mm (◆◆◆)	0.65-2.0m (2.15-6.6ft)	0.65-2.9m (2.15-9.5ft)	0.65-11.6m (2.15-38ft)	0.8*-11.6m (2.6*-38ft)	1.2*-23.1m (3.9*-76ft)
105mm (◆)	0.65-0.8m (2.15-2.6ft)	0.65-1.2m (2.15-3.9ft)	0.65-4.7m (2.15-15ft)	0.65-6.7m (2.15-22ft)	0.65-9.2m (2.15-30ft)

* With high speed film, overexposure may occur at close range due to the film's high speed.

SPECIFICATIONS

Type:	35mm fully automatic lens-shutter with built-in zoom lens and auto flash
Film:	Auto film speed setting with 35mm perforated DX-coded film with ISO rating from 25-3200 (1EV step). Non-DX coded films are automatically set to ISO25
Format:	24x36mm
Film loading:	Auto film loading. Closing the back cover will automatically wind the film to first exposure.
Film winding:	Auto film-winding (single-frame)
Film rewinding:	Auto film rewinding at the end of roll. Auto stop upon completion of rewinding.
Rewinding time:	approx. 20 sec. with 24-exposure film. Rewinding in mid-roll provided.
Frame number:	Automatic readout of successive frame numbers in ascending order when shooting, and descending order when rewinding.
Lens:	Pentax power zoom 38-105mm f/4.5-11 6 elements in 5 groups, Angle of view: 59° - 23.5°
Focusing system:	Pentax infrared active autofocus with focus lock, Autofocusing range: 0.65m (2.1ft) - infinity, maximum magnification: approx. 0.188X. Infinity-landscape mode (focus is fixed to infinity)
Zooming:	Electronic zoom
Shutter:	Programmed AE electronic shutter with speed approx. 1/320 - 1 sec. Bulb: 1/2 sec.-5 min, Electromagnetic release.
Self-timer:	Electronic red lamp indication. Approx. 10 sec. Cancellation after activation is possible.
Viewfinder:	Actual image zoom viewfinder. 83% of field of view ratio, Magnification: 0.42X (38mm) - 1.03X(105mm), Diopter: -0.3 - +1m ⁻¹ , Picture frame, Close distance compensation frame, Green lamp lighting (○): in-focus signal Green lamp blinking: Subject is too close and/or the flash is being charged.

- Exposure control:**-----Programmed auto-exposure control. Range: EV10 - EV17 at 38mm, EV14 - EV19 at 105mm TELE in Auto or Daylight-Sync mode (ISO 400), EV6.5 - EV17 at 38mm EV7.0 -EV19 at 105mm in Slow-Shutter-Speed mode (ISO 400)
- Flash:**-----Built-in flash with red-eye reduction mode, Automatic flash emission in low-luminance, Flash ON= Day-light Sync/Slow-Shutter-Speed Sync (up to 1 sec.), Flash-OFF= Flash override, Bulb-Sync:1/2 sec. - 5min.
- Flash effective range:**----0.65 - 8.2m (38mm) , 0.65 - 3.3m (105mm) (ISO 400 film used).
- Flash recycling time:**----Approx. 5 sec. under Pentax testing conditions.
- Power source:**-----One 3V lithium battery (CR-123A or the equivalent)
- Battery life:**-----Approx.15 rolls of 24 exposure film when 50% of shooting uses flash (under Pentax testing conditions)

Battery exhaustion

warning:-----() appears on the LCD panel, Shutter is locked when () is blinking.

Size & Weight:-----118.5(W) x 69.0(H) x 53.5(D)mm (4.7" x 2.7" x 2.1") 240g (8.5oz) without battery

DATE MODEL

- Date mechanism:**-----Crystal quartz controlled; LCD with digital clock, auto calendar up to 2049.
- Imprinting mode:**-----"Year, Month and Day", "Day, Hour and Minutes", "---- blank", "Month, Day and Year" or "Day, Month and Year".
- Size & Weight:**-----118.5 (W) x 69.0(H) x 55.5(D)mm (4.7" x 2.7" x 2.2") 245g (8.6oz) without battery

SPECIFICATIONS ARE SUBJECT TO CHANGE AT ANY TIME WITHOUT NOTIFICATION OR ANY OBLIGATION ON THE PART OF THE MANUFACTURER.

WARRANTY POLICY

All Pentax cameras purchased through authorized bona fide photographic distribution channels are guaranteed against defects of material or workmanship for a period of twelve months from date of purchase. Service will be rendered, and defective parts will be replaced without cost to you within that period, provided the equipment does not show evidence of impact, sand or liquid damage, mishandling, tampering, battery or chemical corrosion, operation contrary to operating instructions, or modification by an unauthorized repair shop. The manufacturer or its authorized representatives shall not be liable for any repair or alterations except those made with its written consent and shall not be liable for damages from delay or loss of use or from other indirect or consequential damages of any kind, whether caused by defective material or workmanship or otherwise; and it is expressly agreed that the liability of the manufacturer or its representatives under all guarantees or warranties, whether expressed or implied, is strictly limited to the replacement of parts as herein before provided. No refunds will be made on repairs performed by non-authorized Pentax service facilities.

Procedure During 12-month Warranty Period
Any Pentax which proves defective during the 12 month warranty period should be returned to the dealer from whom you purchased the equipment or to the manufacturer. If there is no representative of the manufacturer in your country, send the equipment to the manufacturer, with postage prepaid. In this case, it will take a considerable length of time before the equipment can be returned to you owing to the complicated customs procedures required. If the equipment is covered by warranty, repairs will be made and parts replaced free of charge, and the equipment will be returned to you upon completion of servicing. If the equipment is not covered by warranty, regular charges of the manufacturer or of its representatives will apply. Shipping charges are to be borne by the owner. If your Pentax was purchased outside of the country where you wish to have it serviced during the warranty period, regular handling and servicing fees maybe charged by the manufacturer's representatives in that country. Notwithstanding this, your Pentax returned to the manufacturer will be serviced free of charge according to this procedure and warranty policy.

In any case, however, shipping charges and customs clearance fees are to be borne by the sender. To prove the date of your purchase when required, please keep the receipts or bills covering the purchase of your equipment for at least a year. Before sending your equipment for servicing, please make sure that you are sending it to the manufacture's authorized representatives or their approved repair shops, unless you are sending it directly to the manufacturer. Always obtain a quotation for the service charge, and only after you accept the quoted service charge, instruct the service station to proceed with the servicing.

This warranty does not apply to Pentax products purchased in the United States. Therefore, for warranty information regarding Pentax products purchased in the United States, please read the warranty card supplied with your product.

STATEMENT OF FCC COMPLIANCE

This device complies with Part 15 of the FCC Rules. Operation is subject to the following two conditions : (1) This device may not cause harmful interference, and (2) this device must accept any interference received, including interference that may cause undesired operation.

Changes or modifications not approved by the party responsible for compliance could void the user's authority to operate the equipment. This equipment has been tested and found to comply with the limits for a Class B digital device, pursuant to part 15 of the FCC Rules. These limits are designed to provide reasonable protection against harmful interference in a residential installation. This equipment generates, uses and can radiate radio frequency energy and, if not installed and used in accordance with the instructions, may cause harmful interference to radio communications. However, there is no guarantee that interference will not occur in a particular installation. If this equipment does cause harmful interference to radio or television reception, which can be determined by turning the equipment off and on, the user is encouraged to try to correct the interference by one or more of the following measures :

- Reorient or relocate the receiving antenna.
- Increase the separation between the equipment and receiver.
- Consult the dealer or an experienced radio/TV technician for help.



The CE Mark is a Directive conformity mark of the European Community.



- Asahi Optical Co.,Ltd.** 36-9 Maeno-cho 2-chome, Itabashi-ku, Tokyo 174-8639, JAPAN (<http://www.pentax.co.jp/>)
Pentax GmbH (European Headquarters) Julius-Vosseler-Strasse 104, 22527 Hamburg, GERMANY
([http HQ://pentaxeurope.com/](http://HQ://pentaxeurope.com/) [http Germany://www.pentax.de/](http://Germany://www.pentax.de/))
- Pentax U.K. Limited** Pentax House, Heron Drive, Langley, Slough Berks SL3 8PN, U.K. (<http://www.pentax.co.uk/>)
Pentax FRANCE S.A. 12/14, rue Jean Poulmarch, 95100 Argenteuil, FRANCE
Pentax Benelux B.V. (for Netherlands) Spinveld 25, 4815 HR Breda, NETHERLANDS (<http://www.pentax.nl/>)
(for Belgium & Luxemburg) Weiveldlaan 3-5, 1930 Zaventem, BELGIUM (<http://www.pentax.be/>)
- Pentax (Schweiz) AG** Industriestraße 2, 8305 Dietlikon, SWITZERLAND (<http://www.pentax.ch/>)
Pentax Scandinavia AB P.O. Box 650, 75127 Uppsala, SWEDEN (<http://www.pentax.se/>)
Pentax Europe n.v. (European Distribution Centre) Weiveldlaan 3-5,1930 Zaventem, BELGIUM
Pentax Corporation 35 Inverness Drive East, Englewood, Colorado 80112, U.S.A (<http://www.pentax.com/>)
Pentax Canada Inc. 3131 Universal Drive, Mississauga, Ontario L4X 2E5, CANADA