

DIGITAL Palmcorder®  
CAMCORDER

**Panasonic**®

# Operating Instructions

## Digital Video Camcorder

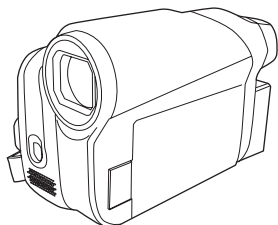

Model No. **PV-GS90P/PC**



Before connecting, operating or adjusting this product,  
please read the instructions completely.

Spanish Quick Use Guide is included.

Guía para rápida consulta en español está incluida.

Mini **DV**

For USA assistance, please call: 1-800-211-PANA(7262) or, contact us via the web at: <http://www.panasonic.com/contactinfo>

For Canadian assistance, please call: 1-800-561-5505 or visit us at [www.panasonic.ca](http://www.panasonic.ca)

LSQT1284 A

## Things You Should Know

### Thank you for choosing Panasonic!

You have purchased one of the most sophisticated and reliable products on the market today. Used properly, we're sure it will bring you and your family years of enjoyment. Please take time to fill in the information on the right.

The serial number is on the tag located on the underside of your Camcorder. Be sure to **retain this manual** as your convenient Camcorder information source.

Date of Purchase \_\_\_\_\_

Dealer Purchased From \_\_\_\_\_

Dealer Address \_\_\_\_\_

Dealer Phone No. \_\_\_\_\_

Model No. \_\_\_\_\_

Serial No. \_\_\_\_\_

## Safety Precautions

**WARNING: TO PREVENT FIRE OR SHOCK HAZARD, DO NOT EXPOSE THIS EQUIPMENT TO RAIN OR MOISTURE.**

Your **MiniDV** Camcorder is designed to record and play back in Standard Play (SP) mode and Long Play (LP) mode

It is recommended that only cassette tapes that have been tested and inspected for use in Camcorder with the **MiniDV** mark be used.

The following mark and symbols are located on bottom of the unit.



The lightning flash with arrowhead symbol, within an equilateral triangle, is intended to alert the user to the presence of uninsulated "dangerous voltage" within the product's enclosure that may be of sufficient magnitude to constitute a risk of electric shock to persons.



The exclamation point within an equilateral triangle is intended to alert the user to the presence of important operating and maintenance (servicing) instructions in the literature accompanying the appliance.

### WARNING:

**TO REDUCE THE RISK OF FIRE, ELECTRIC SHOCK OR PRODUCT DAMAGE,**

- **DO NOT EXPOSE THIS APPARATUS TO RAIN, MOISTURE, DRIPPING OR SPLASHING AND THAT NO OBJECTS FILLED WITH LIQUIDS, SUCH AS VASES, SHALL BE PLACED ON THE APPARATUS.**
- **USE ONLY THE RECOMMENDED ACCESSORIES.**
- **DO NOT REMOVE THE COVER (OR BACK); THERE ARE NO USER SERVICEABLE PARTS INSIDE. REFER SERVICING TO QUALIFIED SERVICE PERSONNEL.**

### CAUTION!

**DO NOT INSTALL OR PLACE THIS UNIT IN A BOOKCASE, BUILT-IN CABINET OR IN ANOTHER CONFINED SPACE. ENSURE THE UNIT IS WELL VENTILATED. TO PREVENT RISK OF ELECTRIC SHOCK OR FIRE HAZARD DUE TO OVERHEATING, ENSURE THAT CURTAINS AND ANY OTHER MATERIALS DO NOT OBSTRUCT THE VENTILATION VENTS.**

**THE FOLLOWING APPLIES ONLY IN THE U.S.A.**

**FCC Note:** This equipment has been tested and found to comply with the limits for a Class B digital device, pursuant to Part 15 of the FCC Rules. These limits are designed to provide reasonable protection against harmful interference in a residential installation. This equipment generates, uses, and can radiate radio frequency energy and, if not installed and used in accordance with the instructions, may cause harmful interference to radio communications. However, there is no guarantee that interference will not occur in a particular installation. If this equipment does cause harmful interference to radio or television reception, which can be determined by turning the equipment off and on, the user is encouraged to try to correct the interference by one or more of the following measures:

- Reorient or relocate the receiving antenna.
- Increase the separation between the equipment and receiver.
- Connect the equipment into an outlet on a circuit different from that to which the receiver is connected.
- Consult the dealer or an experienced radio/TV technician for help.

**FCC Caution:** To assure continued compliance, follow the attached installation instructions and use only shielded interface cables when connecting to computer or peripheral devices. Any changes or modifications not expressly approved by the party responsible for compliance could void the user's authority to operate this equipment.

**Declaration of Conformity**

**Trade Name:** Panasonic  
**Model No.:** PV-GS90P  
**Responsible party:** Panasonic Corporation of North America  
One Panasonic Way, Secaucus, NJ 07094  
**Support Contact:** Panasonic Consumer Electronics Company  
1-800-211-PANA(7262)

This device complies with Part 15 of the FCC Rules. Operation is subject to the following two conditions: (1) This device may not cause harmful interference, and (2) this device must accept any interference received, including interference that may cause undesired operation.

**Panasonic** PV-GS90P



Tested To Comply  
With FCC Standards

FOR HOME OR OFFICE USE

**THE FOLLOWING APPLIES ONLY IN CANADA.**

This Class B digital apparatus complies with Canadian ICES-003.

## **IMPORTANT SAFETY INSTRUCTIONS**

Read these operating instructions carefully before using the unit. Follow the safety instructions on the unit and the applicable safety instructions listed below. Keep these operating instructions handy for future reference.

- 1) Read these instructions.
- 2) Keep these instructions.
- 3) Heed all warnings.
- 4) Follow all instructions.
- 5) Do not use this apparatus near water.
- 6) Clean only with dry cloth.
- 7) Do not block any ventilation openings. Install in accordance with the manufacturer's instructions.
- 8) Do not install near any heat sources such as radiators, heat registers, stoves, or other apparatus (including amplifiers) that produce heat.
- 9) Do not defeat the safety purpose of the polarized or grounding-type plug. A polarized plug has two blades with one wider than the other. A grounding-type plug has two blades and a third grounding prong. The wide blade or the third prong are provided for your safety. If the provided plug does not fit into your outlet, consult an electrician for replacement of the obsolete outlet.
- 10) Protect the power cord from being walked on or pinched particularly at plugs, convenience receptacles, and the point where they exit from the apparatus.
- 11) Only use attachments/accessories specified by the manufacturer.
- 12) Use only with the cart, stand, tripod, bracket, or table specified by the manufacturer, or sold with the apparatus. When a cart is used, use caution when moving the cart/apparatus combination to avoid injury from tip-over.
- 13) Unplug this apparatus during lightning storms or when unused for long periods of time.
- 14) Refer all servicing to qualified service personnel. Servicing is required when the apparatus has been damaged in any way, such as power-supply cord or plug is damaged, liquid has been spilled or objects have fallen into the apparatus, the apparatus has been exposed to rain or moisture, does not operate normally, or has been dropped.



## Precautions

### USE & LOCATION

#### WARNING

- **TO AVOID SHOCK HAZARD ...** Your Camcorder and power supply should not be exposed to rain or moisture. Do not connect the power supply or operate your Camcorder if it gets wet. Your Camcorder has been designed for outdoor use, however it is not designed to sustain direct exposure to water, rain, sleet, snow, sand, dust, or a direct splashing from a pool or even a cup of coffee. This action could permanently damage the internal parts of your Camcorder. Do not attempt to disassemble this unit. There are no user serviceable parts inside. Unplug your Camcorder from the power supply before cleaning.

#### CAUTION

- **DO NOT AIM YOUR CAMCORDER AT THE SUN OR OTHER BRIGHT OBJECTS**
- **DO NOT LEAVE THE CAMCORDER WITH THE EVF AIMED DIRECTLY AT THE SUN AS THIS MAY CAUSE DAMAGE TO THE INTERNAL PARTS OF THE EVF**
- **DO NOT EXPOSE YOUR CAMCORDER TO EXTENDED HIGH TEMPERATURE ...** Such as, in direct sunlight, inside a closed car, next to a heater, etc... This action could permanently damage the internal parts of your Camcorder.
- **AVOID SUDDEN CHANGES IN TEMPERATURE ...** If the unit is suddenly moved from a cold place to a warm place, moisture may form on the tape and inside the unit.

- **DO NOT LEAVE YOUR CAMCORDER OR THE POWER SUPPLY TURNED ON WHEN NOT IN USE.**
- **STORAGE OF YOUR CAMCORDER ...** Store and handle your Camcorder in a manner that will not subject it to unnecessary movement (avoid shaking and striking). Your Camcorder contains a sensitive pick-up device which could be damaged by improper handling or storage.

#### CARE

- **TO CLEAN YOUR CAMCORDER ...** Do not use strong or abrasive detergents when cleaning your Camcorder body.
- **TO PROTECT THE LENS ...** Do not touch the surface of the lens with your hand. Use a commercial Camcorder lens solution and lens paper when cleaning the lens. Improper cleaning can scratch the lens coating.
- **TO PROTECT THE FINISH OF YOUR CAMCORDER ...** Before handling your Camcorder, make sure your hands and face are free from any chemical products, such as suntan lotion, as it may damage the finish.

-If you see this symbol-

#### Information on Disposal in other Countries outside the European Union



This symbol is only valid in the European Union.

If you wish to discard this product, please contact your local authorities or dealer and ask for the correct method of disposal.

## Battery

### 1. Battery pack (Lithium ion battery pack)

- Use the specified unit to recharge the battery pack.
- Do not use the battery pack with equipment other than the specified unit.
- Do not get dirt, sand, liquids, or other foreign matter on the terminals.
- Do not touch the plug terminals (+ and -) with metal objects.
- Do not disassemble, remodel, heat or throw into fire.

If any electrolyte should come into contact with your hands or clothes, wash it off thoroughly with water.

If any electrolyte should come into contact with your eyes, never rub the eyes. Rinse eyes thoroughly with water, and then consult a doctor.

## Warning

Risk of fire, explosion and burns. Do not disassemble, heat above 60°C (140°F) or incinerate.

## AC adaptor

This AC adaptor operates on AC between 110V and 240V.

But

- In the U.S.A. and Canada, the AC adaptor must be connected to a 120V AC power supply only.
- When connecting to an AC supply outside of the U.S.A. or Canada, use a plug adaptor to suit the AC outlet configuration.
- When connecting to a supply of greater than AC 125V, ensure the cord you use is suited to the voltage of the AC supply and the rated current of the AC adaptor.
- Contact an electrical parts distributor for assistance in selecting a suitable AC plug adaptor or AC cord set.

The socket outlet shall be installed near the equipment and easily accessible. The mains plug of the power supply cord shall remain readily operable. To completely disconnect this apparatus from the AC Mains, disconnect the power supply cord plug from AC receptacle.

Product Identification Marking is located on the bottom of units.

U.S. Patent Nos. 6,836,549; 6,381,747; 7,050,698; 6,516,132; and 5,583,936.

This product incorporates copyright protection technology that is protected by U.S. patents and other intellectual property rights. Use of this copyright protection technology must be authorized by Macrovision, and is intended for home and other limited viewing uses only unless otherwise authorized by Macrovision. Reverse engineering or disassembly is prohibited.

## U.S.A./CANADA CONSUMERS: ATTENTION:



A lithium ion/polymer battery that is recyclable powers the product you have purchased. Please call 1-800-8-BATTERY for information on how to recycle this battery.

## Contents

Accessories .....	8
Quick Guide .....	8

### Before using

Parts identification and handling .....	10
How to remove the Sensor tag (for U.S.A. only) .....	11
The grip belt .....	12
Using the lens cover .....	12
Power supply .....	12
Charging time and recordable time .....	13
Selecting a mode (Turning the Camcorder on/off) .....	14
Setting date and time .....	15
Using the LCD monitor .....	16
Using the viewfinder .....	16
Quick Start .....	17
Inserting/removing a cassette .....	18
How to use the joystick .....	19
Help mode .....	20
Language selection .....	20
Using the menu screen .....	20
Adjusting LCD monitor/viewfinder .....	21
Recording with the built-in LED video light ...	22

### Record mode

Check before recording .....	23
Recording on a tape .....	24
Recording check .....	25
Blank search function .....	25
Recording a still picture on a tape (Photoshot) .....	26
Zoom in/out function .....	26
Recording yourself .....	27
Backlight compensation function .....	27
MagicPix function .....	28
Soft skin mode .....	28
Fade in/fade out function .....	29
Wind noise reduction function .....	29
Aspect ratio .....	30
Optical image stabilizer function .....	30
Guideline function .....	30
Auto slow shutter mode .....	31
Recording in various situations (Scene mode) .....	32
Recording in natural colors (White balance) .....	33
Manual focus adjustment .....	33
Manual shutter speed/aperture adjustment ...	34

### Playback mode

Playing back tape .....	35
Frame-by-frame playback .....	36
Playback on TV .....	36

### Edit mode

Copying onto a DVD recorder or a VCR (Dubbing) .....	37
Using the DV Interface Cable for Recording (Digital Dubbing) .....	38
PC Connection with the DV Interface Cable ...	39
Using on Macintosh .....	39
Notes .....	39

### Menu

Menu list .....	40
Menus related to recording .....	41
Menus related to playback .....	41
Other menus .....	41

### Others

Indications .....	42
Warning/alarm indications .....	42
Functions that cannot be used simultaneously .....	43
Before requesting repair (Problems and solutions) .....	44
Cautions for Use .....	46
Explanation of terms .....	49
Specifications .....	50
Camcorder Accessory System .....	51
Camcorder Accessory Order Form (For USA Customers) .....	52
Request for Service Notice (USA Only) .....	53
Limited Warranty (For USA Customers) .....	54
Customer Services Directory .....	55
Warranty (For Canadian Customers) .....	56
Index .....	57
Spanish Quick Use Guide/ Guía española para el uso rápido .....	58

## Accessories

The following are the accessories supplied with this product.

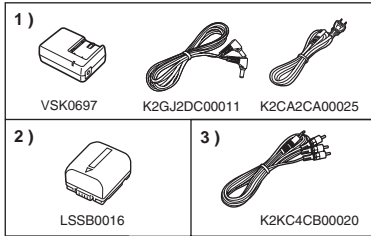

- 1) AC adaptor, DC Cable, AC Cable -13-
- 2) Battery pack -12-
- 3) AV cable -36-, -37-

## Quick Guide

### ■ Charging the battery

- 1 Connect the AC Cable to the AC adaptor and the AC Jack.
- 2 Insert the battery into the battery charger by aligning the arrows.

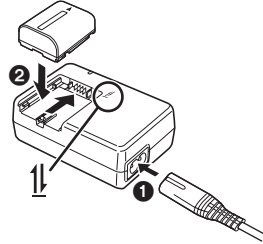

### ■ Inserting the battery

Push the battery against the battery holder and slide it until it clicks.

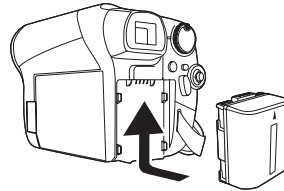

### ■ Inserting/removing a cassette

- 1 Slide the [OPEN/EJECT] lever and open the cassette cover.

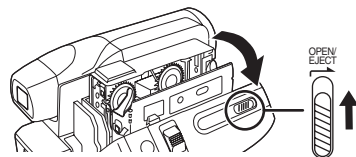

- 2 After the cassette holder is opened, insert/remove the cassette.

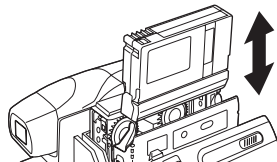



**3** Push the [PUSH] mark **1** in order to close the cassette holder.

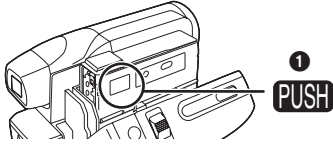

**4** Only after the cassette holder is completely housed, close the cassette cover tightly.

**How to turn on the power**

**1** While pressing the lock release button **A**, set the mode dial to select the desired mode **B**.

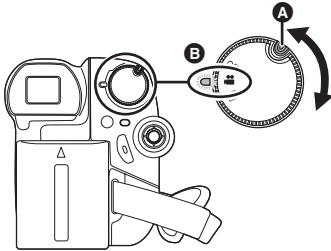

**How to turn off the power**

**1** Set the mode dial to OFF.

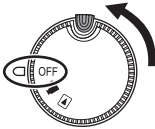

**Recording on a tape**

•Set to Tape Recording Mode.

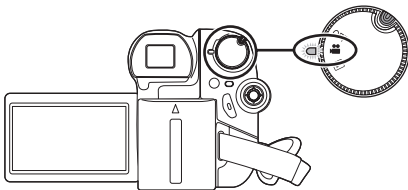

**1** Press the recording start/stop button to start recording.

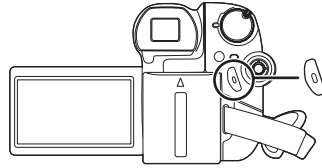

**2** Press the recording start/stop button again to pause recording.



**Playing back tape**

•Set to Tape Playback Mode.

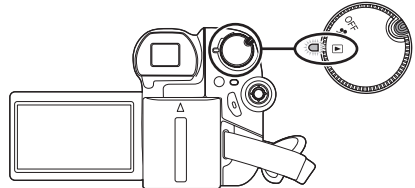

**1** Operate with joystick.



- ▶/||: Playback/Pause
- ◀◀: Rewind/Review playback (Reverts to playback with the ▶/|| icon.)
- ▶▶: Fast forward/Cue playback (Reverts to playback with the ▶/|| icon.)
- : Stop

## Before using

### Parts identification and handling

#### ■ Camcorder

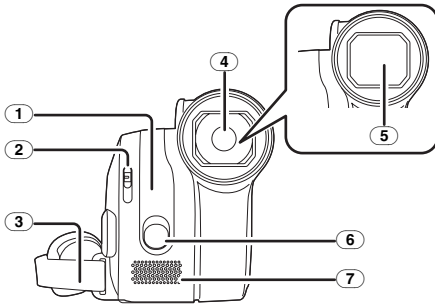

- ① **White balance sensor** -33-
- ② **Lens cover open/close switch** [O/●] -12-
- ③ **Grip belt** -12-
- ④ **Lens**
- ⑤ **Lens cover** -12-
- ⑥ **Built-in LED video light** -22-
- ⑦ **Microphone (built-in, stereo)** -27-, -29-

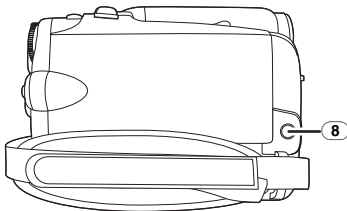

- ⑧ **Audio-video output terminal [A/V]** -36-, -37-  
●Use the supplied AV cable only.

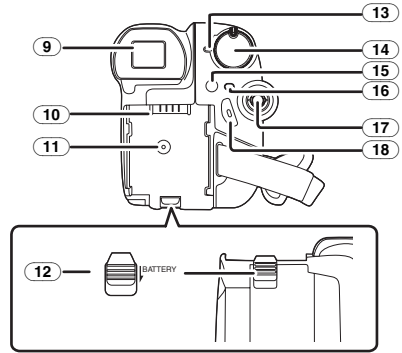

- ⑨ **Viewfinder** -16-, -48-

Due to limitations in LCD production technology, there may be some tiny bright or dark spots on the Viewfinder screen. However, this is not a malfunction and does not affect the recorded picture.

- ⑩ **Battery holder** -13-
- ⑪ **DC input terminal [DC/C.C.IN]** -13-
- ⑫ **Battery release lever [BATTERY]** -13-
- ⑬ **Status indicator** -14-
- ⑭ **Mode dial** -14-
- ⑮ **Optical image stabilizer button [O.I.S.]** -30-
- ⑯ **Menu button [MENU]** -20-
- ⑰ **Joystick** -19-
- ⑱ **Recording start/stop button** -24-

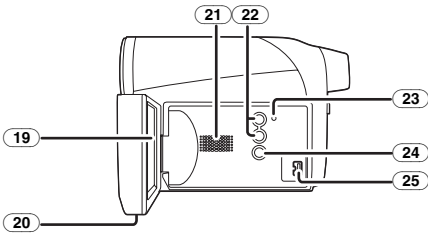

19 LCD monitor -16-, -48-

Due to limitations in LCD production technology, there may be some tiny bright or dark spots on the LCD monitor screen. However, this is not a malfunction and does not affect the recorded picture.

- 20 LCD monitor open part -16-
- 21 Speaker -35-
- 22 Mode select buttons [AUTO]/ [MANUAL AF/MF] -23-, -32-, -33-, -34-
- 23 Reset button [RESET] -43-, -45-
- 24 Light Button [LIGHT] -22-
- 25 DV input/output terminal [DV] -37-, -38-

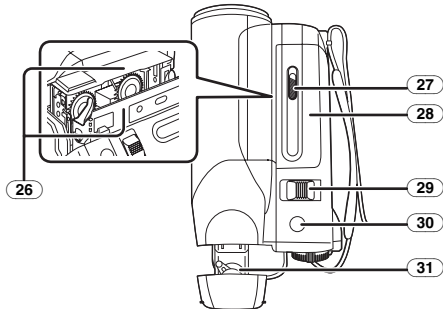

- 26 Cassette holder -18-
- 27 Cassette eject lever [OPEN/EJECT] -18-
- 28 Cassette cover -18-
- 29 Zoom lever [W/T] -26-  
Volume lever [-VOL+] -35-
- 30 Photoshot button [ ] -26-
- 31 Eyepiece corrector knob -16-

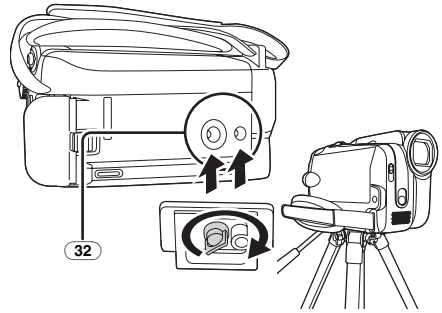

32 Tripod receptacle

This is a hole for attaching the Camcorder to optional tripod. (Please carefully read the operating instructions for how to attach the tripod to the Camcorder.)

### How to remove the Sensor tag (for U.S.A. only)

#### 1 Flip the grip belt.

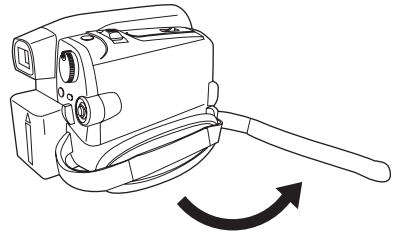

#### 2 Remove the Sensor tag and then fix the grip belt.

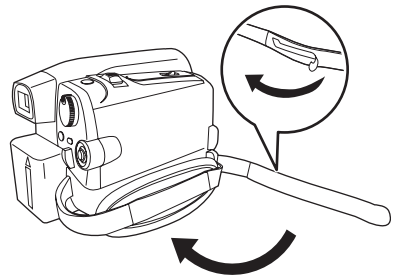

## The grip belt

Adjust the belt length so it fits your hand.

### 1 Adjust the belt length and the pad position.

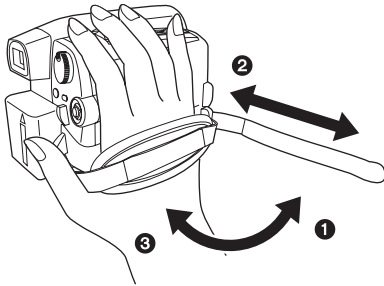

- 1 Flip the belt.
- 2 Adjust the length.
- 3 Fix the belt.

## Using the lens cover

For the lens protection, be sure to close the lens cover when not in use.

### 1 Slide the lens cover open/close switch to [O].

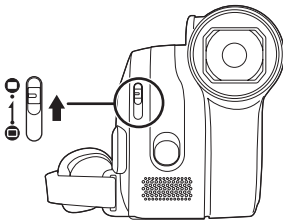

## Power supply

### ■ Charging the battery

When this product is purchased, the battery is not charged. Charge the battery before using this product.

IMPORTANT:

- If the DC Cable is connected to the AC adaptor, then the battery will not get charged. Remove the DC Cable from the AC adaptor.

- Battery charging time. (-13-)
- We recommend using Panasonic batteries. (-8-, -5I-)
- If you use other batteries, we cannot guarantee the quality of this product.

### 1 Connect the AC Cable to the AC adaptor and the AC Jack.

### 2 Insert the battery into the battery charger by aligning the arrows.

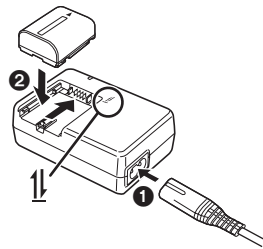

### ■ Charging lamp [CHARGE]

Lights up: Charging

Goes off: Charging completed

Flashing: ● When the battery temperature is excessively high or low, the lamp flashes and the charging time will be longer than normal.

- Remove dirt, foreign objects or dust on the terminals of the battery or the AC adaptor.

If the lamp is still flashing, something may be wrong with the battery or AC adaptor.

Contact consumer support. -55-

### CAUTION

Danger of explosion if battery is incorrectly replaced. Replace only with the same or equivalent type recommended by the manufacturer. Dispose of used batteries according to the manufacturer's instructions.

## ■ Connecting to the AC outlet

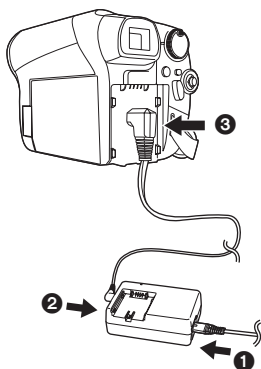

**1** Connect the AC Cable to the AC adaptor and the AC Jack.

**2** Connect the DC Cable to the AC adaptor.

**3** Connect the DC Cable to this unit.

- Do not use the power cord for other equipment since the power cord is exclusively designed for this Camcorder. Do not use the power cord from other equipment for this Camcorder.

## ■ Inserting the battery

Push the battery against the battery holder and slide it until it clicks.

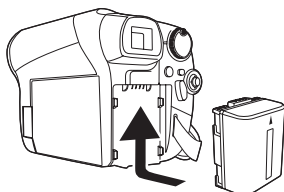

## ■ Removing the battery

While sliding the [BATTERY] lever, slide the battery to remove it.

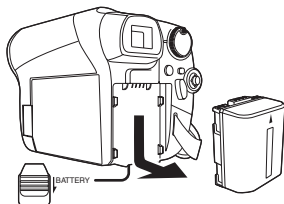

- Hold the battery with your hand so it does not fall.
- Before removing the battery, be sure to set the Mode dial to OFF and check that the status indicator is off.
- Do not heat or expose to flame.
- Do not leave a battery pack in an automobile exposed to direct sunlight for a long period of time with doors and windows closed.

## Charging time and recordable time

The times shown in the tables below are for when the temperature is 25 °C (77 °F) and the humidity is 60%. If the temperature is higher or lower than 25 °C (77 °F), the charging time will become longer.

Supplied battery (7.2 V/ 640 mAh)	(A)	1 h 40 min
	(B)	1 h 45 min (1 h 30 min)
	(C)	55 min (45 min)
VW-VBG130 (7.2 V/ 1320 mAh)	(A)	2 h 35 min
	(B)	3 h (2 h 40 min)
	(C)	1 h 35 min (1 h 20 min)
VW-VBG260 (7.2 V/ 2640 mAh)	(A)	4 h 40 min
	(B)	6 h 5 min (5 h 20 min)
	(C)	3 h 10 min (2 h 45 min)
VW-VBG6 (7.2 V/ 5800 mAh)	(A)	9 h 25 min
	(B)	14 h 5 min (12 h 15 min)
	(C)	7 h 25 min (6 h 25 min)







(A) Charging time

(B) Maximum continuously recordable time

(C) Actual recordable time

(The actual recordable time refers to the recordable time on tape when repeatedly starting/stopping recording, turning the unit on/off, moving the zoom lever etc.)

- The charging time and recordable time shown in the table are approximations. The times indicate the recordable time when the viewfinder is used. The times in parentheses indicate the recordable time when the LCD monitor is used.
- We recommend the Battery Pack VW-VBG130, VW-VBG260 and VW-VBG6 for long recording time (2 hours or more for continuous recording, 1 hour or more for actual recording).
- The actual time may become shorter than this. The recordable time shown in the table are approximations. The recordable time will become shorter in the following cases:
  - When you use both the viewfinder and the LCD monitor simultaneously while rotating the LCD monitor frontward to record yourself, etc.

- The batteries heat up after use or charging. The main unit of the Camcorder being used will also heat up. This is normal.
- Along with the reduction of the battery capacity, the display will change:  →  →  →  → . If the battery discharges, then  (  ) will flash.

## Selecting a mode (Turning the Camcorder on/off)

When recording, open the lens cover before turning the unit on. (-12-) If the unit is turned on with the lens cover closed, the automatic white balance adjustment (-49-) may not function properly.

Rotate the mode dial to select the desired mode or OFF.

- Rotate the mode dial slowly.

### How to turn on the power

1 While pressing the lock release button **A**, set the mode dial to select the desired mode.

- Rotate the mode dial while at the same time pressing in the lock release button if changing from OFF to another mode.
- Align with the mark **B**.

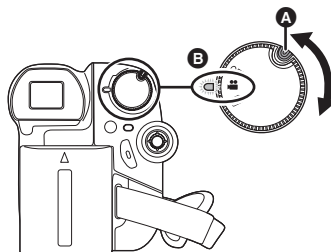



- The Status indicator lights red and the power turns on.

### How to turn off the power

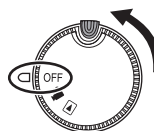
1 Set the mode dial to OFF.



- The Status indicator goes off when the power turns off.

	<b>TAPE RECORDING MODE</b> Use this when you record the image on a tape.
	<b>TAPE PLAYBACK MODE</b> Use this to play back a tape.
OFF	The power turns off.

## ■ How to turn the power on and off with the LCD monitor/viewfinder

When the mode dial is set to Tape Recording Mode, the power can be turned on and off with the LCD monitor and the viewfinder.

### 1 Open the LCD monitor out or extend the viewfinder to turn on the power. (-16-)

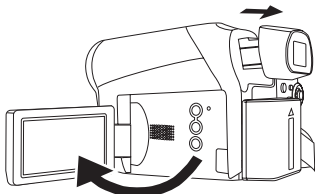

- The LCD monitor or viewfinder will be activated.

### 2 Close the LCD monitor and retract the viewfinder to turn off the power.

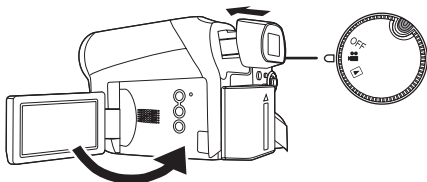

- The power will not turn off unless the LCD monitor is closed and the viewfinder is retracted.
- The Status indicator automatically goes off and the power turns off. (If quick start is set to [ON] (-17-), the unit goes into quick start standby mode and the Status indicator lights green.)
- **The power does not turn off even if the LCD monitor is closed and the viewfinder is retracted while recording on a tape.**

### 3 Open the LCD monitor or extend the viewfinder to turn the power on and use the Camcorder again.

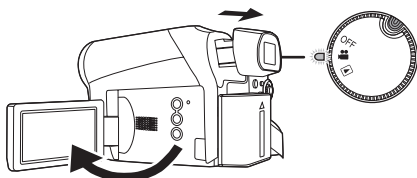

- The Status indicator lights red and the power turns on.

Set the mode dial to OFF when this unit is not being used.

## Setting date and time

When the Camcorder is turned on for the first time, [SET DATE AND TIME] will appear.

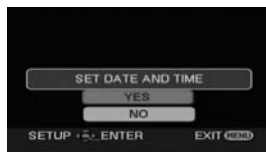

- Select [YES] and press the center of the joystick. Perform steps 2 and 3 below to set the date/time.

### • Set to Tape Recording Mode.

#### 1 Set [BASIC] >> [CLOCK SET] >> [YES]. (-20-)

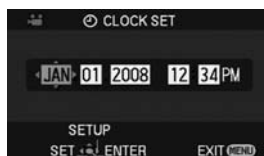

#### 2 Move the joystick left or right in order to select the item to be set. Then move the joystick up or down to set the desired value.

- The year will change as follows: 2000, 2001, ..., 2089, 2000, ...
- The 12-hour clock is used.

#### 3 Press the joystick to determine the setting.

- The clock function starts at [00] seconds.

### ■ About date/time

- The date and time function are driven by a built-in lithium battery.
- Make sure to check the time before recording because the built-in clock is not very accurate.

### ■ Recharging the built-in lithium battery

- If [⊖] or [-] appears when the Camcorder is turned on, then the built-in lithium battery needs to be charged. Use the steps below to charge the battery.

Connect the AC adaptor to the Camcorder or attach the battery to the Camcorder, and the built-in lithium battery will be recharged. Leave the Camcorder as is for approx. 24 hours, and the battery will drive the date and time for approx. 6 months. (The battery is still being recharged even if the mode dial is set to OFF.)

- When turning on the power for the first time after charging, [SET DATE AND TIME] will appear. Select [YES] and set the date and time.

## Using the LCD monitor

You can record the image while viewing it on the opened LCD monitor.

- 1 Pull the LCD monitor out in the direction of the arrow with your fingers.

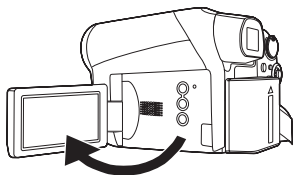

- It can open up to 90°.

- 2 Adjust the angle of the LCD monitor according to your preference.

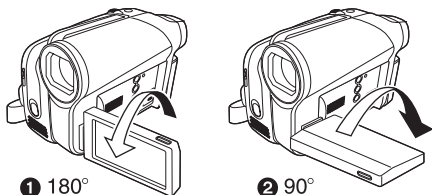

1 180°

2 90°

- It can rotate up to 180° 1 towards the lens or 90° 2 towards the viewfinder.

- The brightness and color level of the LCD monitor can be adjusted from the menu. -21-
- If it is forcibly opened or rotated, the Camcorder may be damaged or fail.
- If the LCD monitor is rotated by 180° towards the lens and the viewfinder is extended (when recording yourself), the LCD monitor and the viewfinder simultaneously light.

## Using the viewfinder

### ■ Extending the viewfinder

- 1 Pull out the viewfinder and extend it by pinching the extension knob.

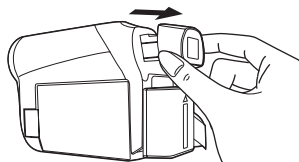

- The viewfinder will be activated. (If the LCD monitor is opened, the viewfinder will be deactivated.)

### ■ Adjusting the viewfinder field of view

- 1 Adjust the focus by sliding the eyepiece corrector knob.

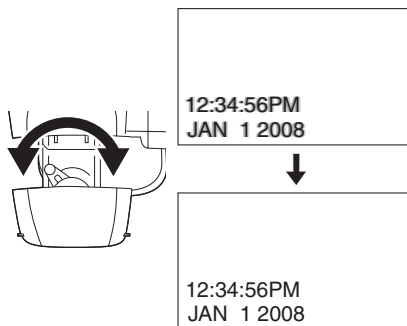

- You can adjust the brightness of the viewfinder from the menu. -21-



## Quick Start

When Quick Start is ON the battery power is still being consumed, even when the LCD Monitor and the Viewfinder are closed.

The Camcorder will resume recording/pause mode about 1.7 seconds after the LCD Monitor or the Viewfinder is reopened.

- Please note in Quick Start Mode approximately half the pause recording power is being consumed. Using Quick Start Mode will reduce the battery recording/playback time.
- This is only activated in the following cases.
  - While using the battery
    - A tape is inserted, while the Tape Recording Mode is set.
  - While using the AC adaptor
    - Quick Start can be used even if a tape is not inserted.

### ● Set to Tape Recording Mode.

**1 Set [SETUP] >> [QUICK START] >> [ON].**  
(-20-)

**2 Close the LCD monitor and retract the viewfinder while the mode dial is set to Tape Recording Mode.**

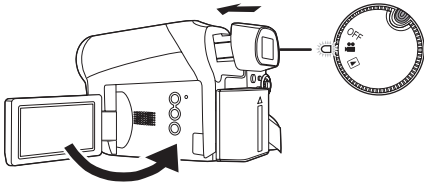

- The Status indicator lights green and the unit goes into quick start standby mode.
- The Camcorder will not go into quick start standby mode unless the LCD monitor is closed and the viewfinder is retracted.

**3 Open the LCD monitor or extend the Viewfinder.**

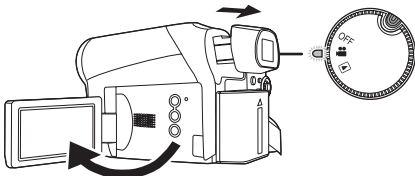

- The status indicator lights red and the Camcorder is put into recording pause approx. 1.7 seconds after it is turned on.

## ■ To cancel Quick Start

**1 Set [SETUP] >> [QUICK START] >> [OFF].**  
(-20-)

- The status indicator goes off and the power turns off if the mode dial is set to OFF while the unit is in quick start standby mode.
- If the standby continues for approx. 30 minutes, then the Status indicator will go off and the Camcorder will be completely turned off.

● In the following cases, quick start is canceled and the power turns off.

- When the Mode dial is moved.
- When the battery or AC adaptor is removed.
- When the tape is removed while using the battery in Tape Recording Mode.
- When the Camcorder is quick-started with the white balance on automatic, it may take some time until the white balance is adjusted if the scene being recorded has a light source different from the scene last recorded. (When the MagicPix function is used, however, the white balance of the scene last recorded is retained.)
- If the power is turned on in quick start standby mode, the zoom magnification becomes 2× and the picture size may differ from what it was before quick start standby mode.
- If [POWER SAVE] (-24-) is set to [5 MINUTES] and the unit automatically goes into quick start standby mode, close the LCD monitor and retract the viewfinder and then open the LCD monitor or extend the viewfinder again.

## Inserting/removing a cassette

- 1 Fit the AC adaptor or the battery and turn on the power.
- 2 Slide the [OPEN/EJECT] lever and open the cassette cover.

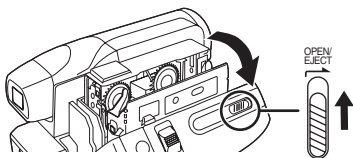

- When the cover is fully opened, the cassette holder will come out.
- 3 After the cassette holder is opened, insert/remove the cassette.

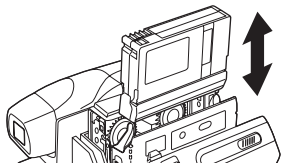

- When inserting a cassette, orient it as shown in the figure, and then securely insert it as far as it goes.
  - When removing, pull it straight out.
- 4 Push the [PUSH] mark ① in order to close the cassette holder.
- The cassette holder is housed.

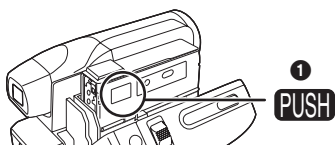

### Caution:

Take care not to trap your fingers under the cassette holder when closing it.

- 5 Only after the cassette holder is completely housed, close the cassette cover tightly.

- When inserting a previously recorded cassette, use the blank search function to find the position where you want to continue recording. If you are overwriting a previously recorded cassette, be sure to find the position where you want to continue recording.
- When closing the cassette cover, do not get anything, such as a cable, caught in the cover.

- After use, be sure to rewind the cassette completely, remove it and put it in a case. Store the case in an upright position. (-48-)
- If the indicator of the condensation does not display on the LCD screen and/or EVF and you notice condensation on the lens or the main unit, do not open the cassette cover otherwise condensation may be formed on the heads or the cassette tape. (-46-)

### ■ When the cassette holder does not come out

- Close the cassette cover completely, and then open it again completely.
- Check if the battery has run down.
- Check if the cassette compartment cover is in contact with grip belt as shown below. If so, be sure the grip belt stays clear of the cover when opening.

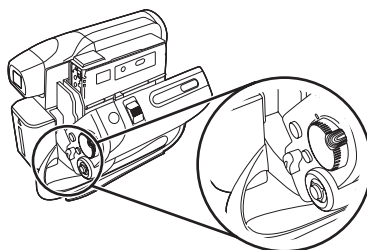

### ■ When the cassette holder cannot be housed

- Set the mode dial to OFF, then to another mode again.
- Check if the battery has run down.

### ■ Accidental erasure prevention

If the accidental erasure prevention slider ① of a cassette is opened (slide in the direction of the [SAVE] arrow), the cassette cannot be recorded. When recording, close the accidental erasure prevention slider of the cassette (slide in the direction of the [REC] arrow).

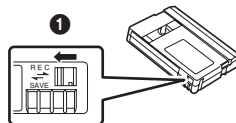

## How to use the joystick

### Basic joystick operations

#### Operations on the menu screen

Move the joystick up, down, left, or right to select an item, and then push in the center to set it.

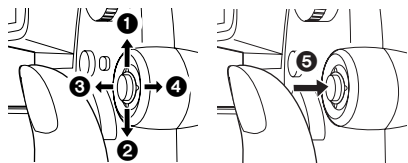

1	Select by moving up.
2	Select by moving down.
3	Select by moving left.
4	Select by moving right.
5	Determine by pushing the center.

### Joystick and screen display

Push the center of the joystick, and icons will be displayed on the screen. Each time the joystick is moved down, the indication changes.

(In the Tape playback mode, the icons will be automatically displayed on the screen.)

#### 1) Tape recording mode

(When the [AUTO] button is pressed to set to auto mode.)

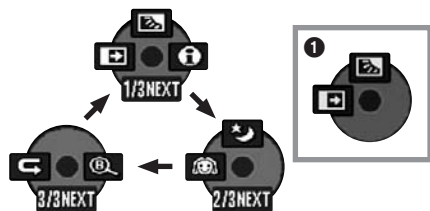

1/3	◀	▶	Fade	-29-
	▲	■	Backlight compensation	-27-
	▶	ⓘ	Help mode	-20-
2/3	◀	Ⓢ	Soft skin mode	-28-
	▲	★	MagicPix	-28-
3/3	◀	Ⓜ	Recording check	-25-
	▶	Ⓜ	Blank search	-25-

● 1 is displayed while recording on a tape.

#### 2) Tape recording mode

(When the [MANUAL AF/MF] button is pressed to set to manual mode.)

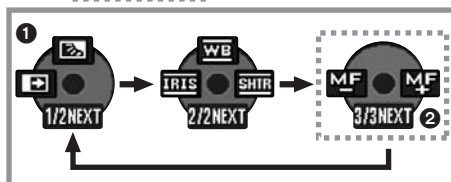
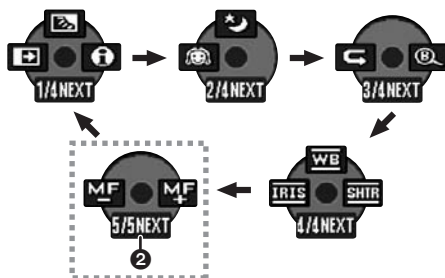

4/4	◀	IRIS	Iris or gain value	-34-
	▲	WB	White balance	-33-
	▶	SHTR	Shutter speed	-34-
5/5	◀	MF	Manual focus adjustment	-33-
	▶	MF+		

- 1 is displayed while recording on a tape.
- 2 is displayed only when the [MANUAL AF/MF] button is pressed again to set to manual focus mode.

#### 3) Tape playback mode



▲	▶/	Playback/pause	-35-
▼	■	Stop	-35-
◀	◀◀	Rewind (review playback)	-35-
▶	▶▶	Fast forward (cue playback)	-35-

## Help mode

Select an icon for an explanation of the function.

### ● Set to Tape Recording Mode.

- 1 Press the joystick to display the icon during the recording pause. Move the joystick down until icon ① appears.



- 2 Move the joystick right to select the Help mode icon [①].



- 3 Move the joystick up, left, or right to select the desired icon.

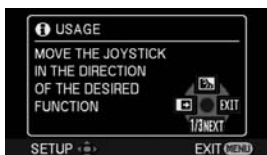

- An explanation of the selected icon is displayed on the screen.
- Each time the joystick is moved down, the indication changes.

### ■ To exit the Help mode

Select [EXIT] icon or press the [MENU] button.

- When the Help mode is used, it is not possible to record or set the functions.

## Language selection

You can select the language on the screen display and the menu screen.

- 1 Set [LANGUAGE] >> select the desired language.



## Using the menu screen

For each individual menu, please refer to -40-.

- 1 Press the [MENU] button.

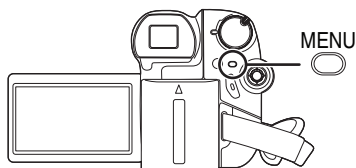

- The menu corresponding to the mode selected by the mode dial is displayed.
- Do not switch the mode dial when the menu is displayed.

- 2 Move the joystick up or down in order to select the top menu.

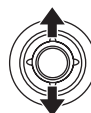

- 3 Move the joystick right or press it to set the selection.



- 4 Move the joystick up or down in order to select the sub-menu.

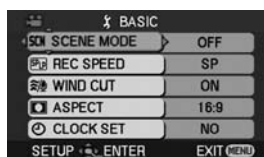

- 5 Move the joystick right or press it to set the selection.



- 6 Move the joystick up or down in order to select the item to be set.

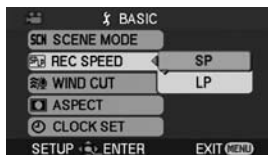

- 7 Press the joystick to determine the setting.



■ **To exit the menu screen**

Press the [MENU] button.

■ **To get back to the previous screen**

Move the joystick left.



■ **About the menu setting**

- The menu is not displayed while recording on a tape. Also, you cannot record on a tape while the menu is displayed.

## Adjusting LCD monitor/viewfinder

■ **Adjusting the brightness and color level**

- 1 Set [SETUP] >> [LCD SET] or [EVF SET] >> [YES].



- 2 Move the joystick up or down in order to select the item to be adjusted.

[LCD SET]

- When the LCD monitor is rotated by 180° towards the lens, the brightness of the LCD monitor cannot be adjusted.
- These settings will not affect the images actually recorded.

☀ : **Brightness of the LCD monitor**

⊗ : **Color level of the LCD monitor**

[EVF SET]

- To adjust the brightness of the viewfinder, close the LCD monitor and extend the viewfinder to activate it.
- These settings will not affect the images actually recorded.

☀ : **Brightness of the viewfinder**

- 3 Move the joystick left or right to move the bar indication representing the brightness.

- 4 Press the [MENU] button or the joystick to complete the settings.

## **Recording with the built-in LED video light**

### **1 Press the [LIGHT] button.**

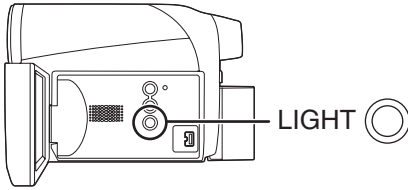

- The [LD] indication appears on the LCD monitor.

### **■ To cancel the built-in LED video light**

Press the [LIGHT] button again.

- The subject should be within 1.5 metres (4.9 feet) of the Camcorder.
- Using the LED video light reduces battery time.
- Set the LED video light to off when not in use.
- Do not look directly into the light.
- Using the MagicPix function at the same time will make conditions even brighter.
- The LED video light enables simply lightening the images taken in a dimly-lit place. We also recommend using it in a bright place to obtain high quality images.

## Record mode

### Check before recording

Check the following before recording important events such as weddings or when the Camcorder has not been used for a long time.

Conduct a test recording to make sure that the image recording and the audio recording work properly.

### Basic Camcorder positioning

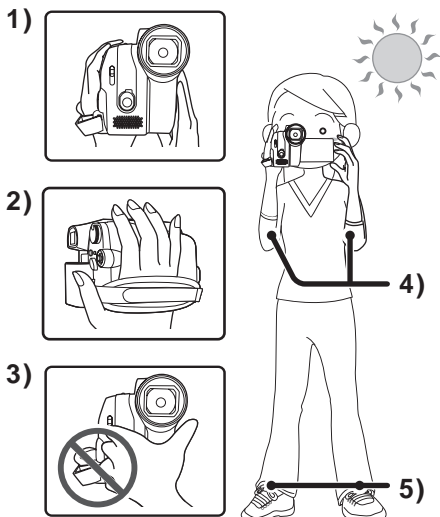

- 1) Hold the Camcorder with both hands.
  - 2) Put your hand through the grip belt.
  - 3) Do not cover the microphones or sensors with your hands.
  - 4) Keep your arms near your body.
  - 5) Separate your legs for better balance.
- When you are outdoors, record pictures with the sunlight as far in the background as possible. If the subject is backlit, it will become dark in the recording.

### Check points

- Grip belt adjustment (-12-)
- Open the LCD monitor or extend the viewfinder. (Recording cannot start while the LCD monitor is closed and the viewfinder is retracted. Even if the LCD monitor and viewfinder are closed during recording, the power will not turn off until recording stops.)
- Adjusting LCD monitor/viewfinder (-21-)
- Power supply (-12-)
- Insert a cassette (-18-)
- Setting date/time (-15-)
- Setting SP/LP mode

### About auto mode

- Press the [AUTO] button and the color balance (white balance) and focusing will be adjusted automatically. (The [AUTO] indication appears on the screen.)
  - Auto white balance: -49-
  - Auto focusing: -49-
- Depending on the brightness of the subject etc., the aperture and shutter speed are automatically adjusted for an optimum brightness. (When set to the tape recording mode: The shutter speed is adjusted to a maximum of 1/250.)
- Color balance and focus may not be adjusted depending on light sources or scenes. If so, manually adjust the white balance and focus.

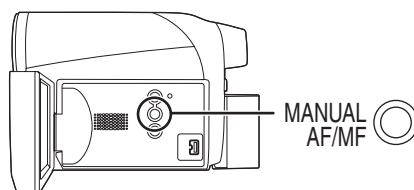

- Scene mode (-32-)
- White balance (-33-)
- Shutter speed (-34-)
- Iris/gain value (-34-)
- Focus (-33-)

### Recording mode

You can switch the tape recording mode.

#### Set to Tape Recording/Playback Mode.

- 1 Set [BASIC] or [ADVANCED] >> [REC SPEED] >> [SP] or [LP].

If the LP mode is selected, the recording time will be 1.5 times the SP mode, but some functions will be disabled.

- We recommend using the SP mode for important recording.
- In order to fully exhibit the performances of the LP mode, we recommend using Panasonic cassettes marked LP mode.
- In the LP mode, the picture quality will not be degraded in comparison with the SP mode, but mosaic noise may appear on the playback image or some functions may be disabled.
  - Playback on other digital video equipment or on digital video equipment without the LP mode.
  - Playback of the image on other digital video equipment recorded in the LP mode.
  - Frame-by-frame playback.

## Recording on a tape

When recording, open the lens cover before turning the unit on. (-12-) If the unit is turned on with the lens cover closed, the automatic white balance adjustment (-49-) may not function properly.

The default aspect ratio is set to [16:9] for recording images compatible with a wide-screen TV. To make this unit compatible with regular TVs (4:3), change the [ASPECT] setting before recording the images (-30-) or change the [TV ASPECT] setting when watching them on the connected TV (-36-).

### ● Set to Tape Recording Mode.

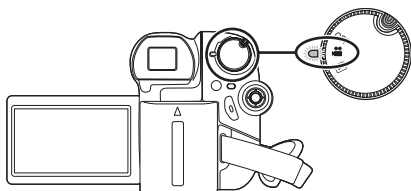

**1 Press the recording start/stop button to start recording.**

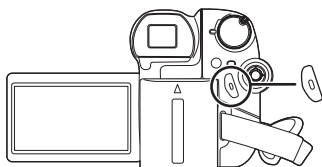

**2 Press the recording start/stop button again to pause recording.**

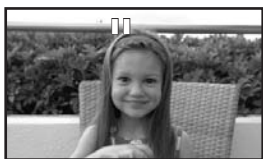

- For the recording time on a tape, refer to -13-.
- Carry out a recording check to verify that the image is recorded properly.
- In order to find the unrecorded section, carry out the blank search (-25-).

## ■ On-screen display in the tape recording mode



- 1) Recording time elapse
- 2) Remaining tape indication

## ■ About the remaining tape time indication on the screen

- The remaining tape time is indicated in minutes. (When it reaches less than 3 minutes, the indication starts flashing.)
- During a 15-second or shorter recording, the remaining tape time indication may not be displayed or the remaining tape time may not be displayed correctly.
- In some cases, the remaining tape time indication may display remaining tape time that is 2 to 3 minutes shorter than the actual remaining tape time.

## ■ [POWER SAVE]

- [OFF]: When 5 minutes passes without any operation, the standby mode will be automatically set. In the standby mode, [■■] blinks and it takes more time than usual to start recording after you press the recording start/stop button.
- [5 MINUTES]: When 5 minutes passes without any operation, the Camcorder automatically turns off to protect the tape or to save battery life. To use the Camcorder, turn it on again.
- In the following cases, the power may not turn off even when set [POWER SAVE] >> [5 MINUTES].
    - When connecting to the AC outlet (When using the AC adaptor)
    - When connecting the DV cable to a PC or other equipment



## Recording check

The last image recorded is played back for 2 to 3 seconds. After checking, the Camcorder will be set to recording pause.

### •Set to Tape Recording Mode.

- 1 Press the joystick to display the icon during the recording pause. Move the joystick down until icon ❶ appears.
- 2 Move the joystick left to select the recording check icon [ ⏪ ].



- The [RECORDING CHECK STARTED] indication appears on the screen of the Camcorder.

## Blank search function

Searches for the last part of the image recorded (unused part of the tape). After the search is finished, the blank search function is canceled and the Camcorder is put into recording pause.

### •Set to Tape Recording Mode.

- 1 Press the joystick to display the icon during the recording pause. Move the joystick down until icon ❶ appears.
- 2 Move the joystick right to select the blank search icon [ ⏮ ].



- 3 When the confirmation message appears, select [YES] and press the center of the joystick.

### ■ Stopping blank search midway through

Move the joystick down to select the [■] icon.

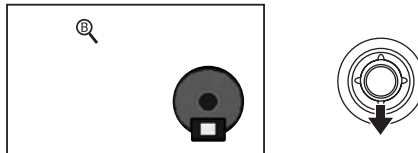

- If the cassette tape has no blank part, then the Camcorder will stop at the end of the tape.
- The Camcorder stops at a point approx. 1 second before the end of the last image recorded. When you start recording at that point, the image can be recorded seamlessly from the last image.

## Recording a still picture on a tape (Photoshot)

- Set to Tape Recording Mode.

1 Press the Photoshot button [  ] in the recording pause mode.

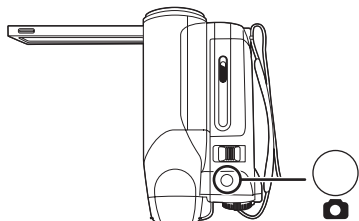

- The Camcorder records a still picture for about 7 seconds and then switches back to the recording pause mode.
- If you set [ADVANCED] >> [SHTR EFFECT] >> [ON], you can add image and a sound like releasing the shutter.



- Photoshot recording results in slightly inferior image quality.

### ■ Continuous photoshot

If you set [ADVANCED] >> [SHTR EFFECT] >> [ON] and keep the [  ] button pressed, the Camcorder will continuously record still pictures in approx. 0.7 seconds intervals until the button is released.

- The screen blinks and, at the same time, a shutter clicking sound is recorded.

## Zoom in/out function

You can zoom in up to 42× optically.

- Set to Tape Recording Mode.

1 **Wide-angle recording (zoom out):**  
Push the [W/T] lever towards [W].  
**Close-up recording (zoom in):**  
Push the [W/T] lever towards [T].

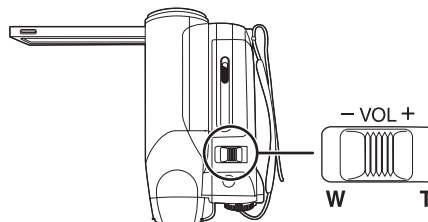

- When zooming in and taking a picture while holding the Camcorder by hand, we recommend using the optical image stabilizer function. -30-
- When you are zooming in on a faraway subject, a sharper focus is achieved if the recording subject is 1.3 m (4.3 feet) or further from the Camcorder.
- When the zoom speed is high, the subject may not be focused easily.
- When the zoom magnification is 1×, the Camcorder can focus on a subject approx. 2 cm (0.8 inches) away from the lens.
- Be aware that a mechanical sound may be recorded when the [W/T] lever is released while zooming. Gently move the zoom lever back to its original position before releasing it.

## Digital zoom function

If the zoom magnification exceeds 42×, then the digital zoom function will be activated. The digital zoom function allows you to select a magnification from 70× to 2000×.

### ● Set to Tape Recording Mode.

1 Set [ADVANCED] >> [D.ZOOM] >> [70×] or [2000×].



[OFF]: Optical zoom only (Up to 42×)

[70×]: Digital zoom (Up to 70×)

[2000×]: Digital zoom (Up to 2000×)

- The larger the digital zoom magnification, the more the image quality is degraded.

## About the variable speed zoom function

- The zoom speed varies according to the amount of movement of the [W/T] lever.

## To use the zoom microphone function

Interlocked with the zooming operation, the microphone will clearly capture sounds far away with the tele-shot or those in the vicinity with the wide-angle shot.

### ● Set to Tape Recording Mode.

1 Set [ADVANCED] >> [ZOOM MIC] >> [ON].



## Recording yourself

You can record yourself while viewing the LCD monitor. You can record persons in front of the Camcorder while presenting them the image. The image is horizontally flipped as if you see a mirror image. (However the image to be recorded is not altered.)

- **Extend the viewfinder to see the picture while recording.**

1 Rotate the LCD monitor towards the lens side.

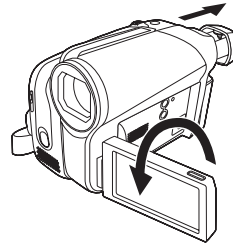

- When the Wide function is set, a vertically oriented display appears on the viewfinder screen, this is normal and not indicative of any trouble.
- When the LCD monitor is rotated towards the lens side, the icon will not be displayed even if you push the center of the joystick.

## Backlight compensation function

This protects a backlit subject from being darkened.

### ● Set to Tape Recording Mode.

1 Press the joystick to display the icon. Move the joystick down until icon ① appears.

2 Move the joystick up to select the backlight compensation icon [B.C.].

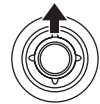

- The [BACKLIGHT COMPENSATION ON] indication appears on the screen of the Camcorder.
- The image on the screen will become brighter.

## To return to normal recording

Select the [B.C.] icon again.

- The [BACKLIGHT COMPENSATION OFF] indication appears on the screen of the Camcorder.

- Backlight compensation is canceled when you turn off the power or operate the mode dial.
- Backlight compensation is canceled when you activate the MagicPix function.

## MagicPix function

This function allows you to record color subjects in dark locations to stand out against the background.

Attach the Camcorder to a tripod, and you can record images free from vibration.

- Recorded scene is seen as if frames were missed.

### ● Set to Tape Recording Mode.

**1 Press the joystick to display the icon. Move the joystick down until icon ❶ appears.**

**2 Move the joystick up to select the MagicPix icon [☾].**

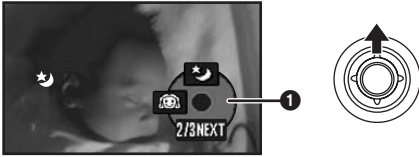

- The [MAGICPIX ON] indication appears on the screen of the Camcorder.
- If it is difficult to focus, adjust the focus manually. (-33-)

### ■ To cancel the MagicPix function

Select the [☾] icon again.

- The [MAGICPIX OFF] indication appears on the screen of the Camcorder.

- If set in a bright place, the screen may become washed out for a while.
- The MagicPix function makes the signal charging time of the CCD up to approximately 30× longer than usual, so that dark scenes (a minimum of 2 lx) can be recorded brightly. For this reason, bright dots that are usually invisible may be seen, but this is not a malfunction.
- The MagicPix function is canceled when you turn off the power or operate the mode dial.

## Soft skin mode

This allows the skin color to be recorded in a softer tone. This is more effective if you record a person closely from the torso up.

### ● Set to Tape Recording Mode.

**1 Press the joystick to display the icon. Move the joystick down until icon ❶ appears.**

**2 Move the joystick left to select the soft skin icon [☺].**



- The [SOFT SKIN MODE ON] indication appears on the screen of the Camcorder.

### ■ To cancel the soft skin mode

Select the [☺] icon again.

- The [SOFT SKIN MODE OFF] indication appears on the screen of the Camcorder.

- If the background or anything else in the scene has colors similar to the skin color, they will also be smoothed.
- If the brightness is insufficient, the effect may not be clear.

## Fade in/fade out function

### Fade in

The image and audio gradually appear.

### Fade out

The image and audio gradually disappear.

#### ● Set to Tape Recording Mode.

- 1 Press the joystick to display the icon. Move the joystick down until icon ❶ appears.
- 2 Move the joystick left to select the fade icon [↩].

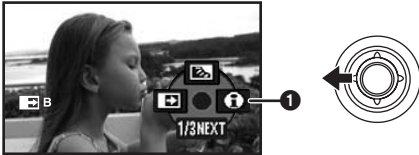

- The [FADE ON] indication appears on the screen of the Camcorder.

#### 3 Press the recording start/stop button.

### Start recording. (fade in)

When you start recording, the image/audio disappears completely and the image/audio gradually appears.



### Pause recording. (fade out)

The image/audio gradually disappears. After the image/audio completely disappears, recording stops.



### ■ To cancel fading

Select the [↩] icon again.

- The [FADE OFF] indication appears on the screen of the Camcorder.

### ■ To select the color for fade in/fade out

The color which appears in fading pictures can be selected.

- 1 Set [ADVANCED] >> [FADE COLOR] >> [BLACK] or [WHITE].

- While the fade in/fade out function is selected, it takes several seconds to display the image when you start recording images. Besides, it also takes several seconds to pause recording.

## Wind noise reduction function

#### ● Set to Tape Recording Mode.

- 1 Set [BASIC] >> [WIND CUT] >> [ON].



### ■ To cancel the wind noise reduction function

Set [BASIC] >> [WIND CUT] >> [OFF].

- The default setting is [ON].
- Reduces the wind noise depending on the wind strength. (If this function is activated in strong winds, the stereo effect may be reduced. When the wind weakens, the stereo effect will be restored.)

## Aspect ratio

This allows you to record images compatible with wide-screen TVs.

### Wide Function

Images are recorded with a 16:9 aspect ratio.

### 4:3 Function

Images are recorded with a 4:3 aspect ratio.

#### ● Set to Tape Recording Mode.

#### 1 Wide Function

Set [BASIC] >> [ASPECT] >> [16:9].

#### 4:3 Function

Set [BASIC] >> [ASPECT] >> [4:3].

### ■ To cancel the Wide/4:3 function

#### Wide Function

Set [BASIC] >> [ASPECT] >> [4:3].

#### 4:3 Function

Set [BASIC] >> [ASPECT] >> [16:9].

- The default setting is [16:9].
- In the wide-screen mode, the menu screens, operation icons and other screen displays appear horizontally oriented.
- When images are played back on a TV screen, the date/time indication may be erased in some cases.
- Depending on the TV, the picture quality may deteriorate.
- If still pictures recorded with a 4:3 aspect ratio are played back when [TV ASPECT] is set to [16:9], part of the operation icons and other displays will appear on the black bands on the left and right of the picture.
- About the TV to be connected and TV used for playback
  - When playing back images taken by this unit on a TV screen, change the setting established by Tape playback mode [SETUP] >> [TV ASPECT] to match the aspect ratio (4:3 or 16:9) of the TV monitor to be connected. (-36-)
  - Depending on the settings of the TV connected, the images may not be displayed properly. For more information, please read the operating instructions for the TV.

## Optical image stabilizer function

Reduces the jitter caused by hand movement when recording.

#### ● Set to Tape Recording Mode.

#### 1 Press the [O.I.S.] button.



### ■ To cancel the optical image stabilizer function

Press the [O.I.S.] button again.

- In the following cases, the optical image stabilizer function may not work effectively.
  - When the digital zoom is used
  - When the Camcorder is shaken greatly
  - When you record a moving subject while tracking it

## Guideline function

View the slope and the balance of the image while recording.

You can check if the image is level while recording motion pictures. The function can also be used to estimate the balance of the composition.

#### ● Set to Tape Recording Mode.

#### 1 Set [ADVANCED] >> [GUIDE LINES] >> [ON].



### ■ To cancel the guideline function

Set [ADVANCED] >> [GUIDE LINES] >> [OFF].

- The guide lines do not appear on the images actually recorded.

---

## ***Auto slow shutter mode***

---

You can record bright pictures even in dark places by slowing the shutter speed.

● **Set to Tape Recording Mode.**

**1** Set [ADVANCED] >> [AUTO SLW SHTR] >> [ON].

- When auto slow shutter mode is selected, the shutter speed is adjusted between 1/30 and 1/250 depending on the surrounding brightness.
- When adjusting the shutter speed manually, it can be adjusted between 1/30 and 1/8000. (-34-)

■ **To cancel the slow shutter mode**

Set [ADVANCED] >> [AUTO SLW SHTR] >> [OFF].

- If [AUTO SLW SHTR] is set to [OFF], then the shutter speed will be set between 1/60 and 1/250. (When adjusting the shutter speed manually, it can be adjusted between 1/60 and 1/8000.)
- 
- This function's default setting is [ON].
  - If the scene is low in brightness or contrast, the subject may not be focused in on.
  - When the shutter speed becomes 1/30, the screen may appear as if frames are missed and afterimages may appear.

## Recording in various situations (Scene mode)

When you record images in different situations, this mode automatically sets optimum shutter speeds and apertures.



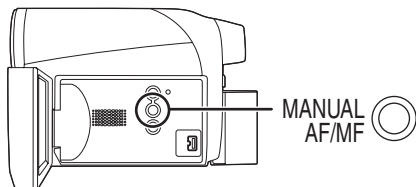

### ● Set to Tape Recording Mode.

#### 1 Press the [MANUAL AF/MF] button.

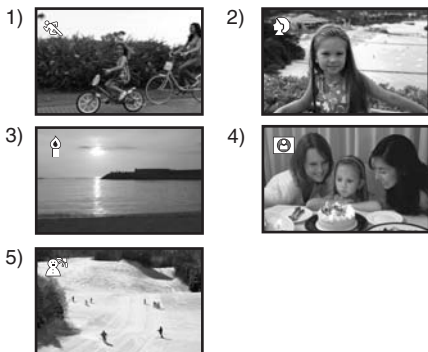

#### 2 Set [BASIC] >> [SCENE MODE] >> select the desired mode.



- 1) [  ] **Sports mode**
  - To record sports scenes or scenes where there are quick motions
- 2) [  ] **Portrait mode**
  - To make people stand out against the background
- 3) [  ] **Low light mode**
  - To make the scene brighter in dark conditions
- 4) [  ] **Spotlight mode**
  - To make the subject under a spotlight look more attractive
- 5) [  ] **Surf & snow mode**
  - To record images in bright places such as ski slopes and beaches

### ■ To cancel the scene mode function

Set [BASIC] >> [SCENE MODE] >> [OFF] or press the [AUTO] button.

#### Sports mode

- This mode reduces Camcorder shakes for the playback pause of recorded pictures.
- During normal playback, the image movement may not look smooth.
- Avoid recording under fluorescent light, mercury light or sodium light because the color and brightness of the playback image may change.
- If you record a subject illuminated with bright light or a highly reflective subject, vertical lines of light may appear.
- If the brightness is insufficient, the sports mode does not function. The [  ] indication flashes.
- If this mode is used indoors, the screen may flicker.

#### Portrait mode

- If this mode is used indoors, the screen may flicker. If so, change the scene mode setting to [OFF].

#### Low light mode

- Extremely dark scenes may not be able to be recorded finely.

#### Spotlight mode

- If the recording subject is extremely bright, the subject may become washed out and the periphery extremely darkened.

#### Surf & snow mode

- If the recording subject is extremely bright, the recorded image may become washed out.



## Recording in natural colors (White balance)

The automatic white balance function may not reproduce natural colors depending on the scenes or lighting conditions. If so, you can adjust the white balance manually.

### ● Set to Tape Recording Mode.

1 Press the [MANUAL AF/MF] button.

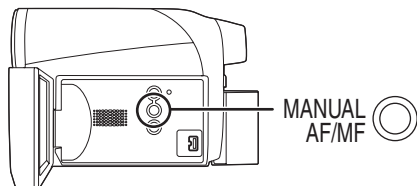

2 Move the joystick up to select the white balance icon [WB].



3 Move the joystick left or right in order to select the white balance mode.

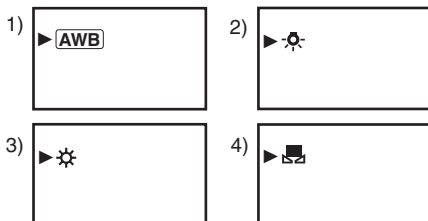

- 1) Auto white balance adjustment [AWB]
- 2) Indoor mode (for recording under incandescent lamps) [☀️]
- 3) Outdoor mode [🌳]
- 4) Manual adjustment mode [👁️]

### ■ To restore to the automatic adjustment

Move the joystick left or right until the [AWB] indication appears. Or, press the [AUTO] button.

- When the Camcorder is turned on with the lens cover closed, the automatic white balance adjustment may not function properly. Please turn the Camcorder on after opening the lens cover.
- When setting both the white balance and the iris/gain, set the white balance first.
- Whenever recording conditions change, re-set the white balance for correct adjustment.

### ■ To set the white balance manually

Select [MNL] in Step 3. Then, while viewing a white subject on the entire screen, move the joystick up to select the [WB] indication.

- The white balance is set when the [WB] indication stops flashing.

### ■ About flashing of the [WB] indication

When the manual adjustment mode is selected

- Flashing indicates that the white balance previously adjusted is stored. This setting is stored until the white balance is adjusted again.

When white balance cannot be set in the manual adjustment mode

- White balance may not be adjusted properly in the manual adjustment mode in dark places. If required, use the auto white balance mode.

Setting in the manual adjustment mode

- When the setting is completed, it will keep lit.

### ■ White balance sensor

The white balance sensor detects the type of light source during recording.

- Do not cover the white balance sensor during recording, or it may not function properly.

## Manual focus adjustment

If auto focusing is difficult due to the conditions, then use manual focus.

### ● Set to Tape Recording Mode.

1 Press the [MANUAL AF/MF] button until the icon ❶ appears.

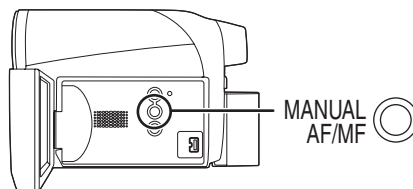

- The [MNL] indication and the manual focus [MF] indication appears.

## 2 Move the joystick left or right in order to adjust the focus.



- When focused with a wide angle, the subject may not be in focus when zoomed in. First, zoom in on the subject, and then focus on it.

### ■ To restore to the automatic adjustment

Press the [MANUAL AF/MF] button again or press the [AUTO] button.

## Manual shutter speed/aperture adjustment

### Shutter Speed

Adjust it when recording fast-moving subjects.

### Aperture

Adjust it when the screen is too bright or too dark.

- Set to Tape Recording Mode.

### 1 Press the [MANUAL AF/MF] button.

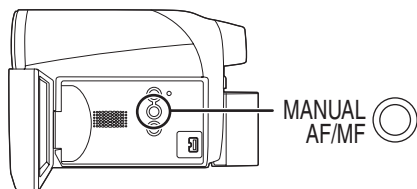

### 2 Move the joystick left or right to select aperture icon [IRIS] or shutter speed icon [SHTR] .



## 3 Move the joystick left or right in order to adjust the shutter speed or aperture.

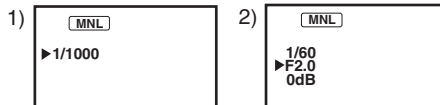

- 1) Shutter speed
- 2) (Aperture) Iris/gain value

### ■ To restore to automatic adjustment

Press the [AUTO] button.

### Manual shutter speed adjustment

- Avoid recording under fluorescent light, mercury light or sodium light because the color and brightness of the playback image may change.
- If you increase the shutter speed manually, the noise on the screen may increase.
- You may see vertical lines of light in the playback image of a brightly shining subject or highly reflective subject, but this is not a malfunction.
- During normal playback, image movement may not look smooth.
- When recording in an extremely bright place, the color of the screen may change or flicker. If this happens adjust the shutter speed manually to [1/60] or [1/100].

### Manual iris/gain adjustment

- Set the shutter speed before setting the aperture (iris/gain) when manually adjusting both settings.
- If the value does not become "OPEN", you cannot adjust the gain value.
- If the gain value is increased, the noise on the screen increases.
- Depending on the zoom magnification, there are iris values that are not displayed.

### ■ Shutter speed range

1/30 to 1/8000 seconds: Tape Recording Mode  
The shutter speed closer to 1/8000 is faster.  
If [AUTO SLW SHTR] is set to [OFF], then the shutter speed will be set between 1/60 and 1/8000.

### ■ Iris/gain value range

CLOSE (Closed), F16, ..., F2.0,  
OPEN (Opened: F1.8) 0dB, ..., 18dB  
Value closer to [CLOSE] darkens the image.  
Value closer to [18dB] brightens the image.  
Values with dB are gain values.

## Playback mode

### Playing back tape

- Set to Tape Playback Mode.  
(An operation icon automatically appears on the LCD monitor.)

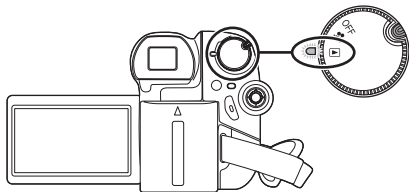

#### 1 Operate with joystick.



- ▶/||: Playback/Pause
- ◀◀: Rewind/Review playback (Reverts to playback with the ▶/|| icon.)
- ▶▶: Fast forward/Cue playback (Reverts to playback with the ▶/|| icon.)
- : Stop

- The power will not turn off when the LCD monitor and the viewfinder are closed and retracted during Tape playback mode.
- During cue/review playback, fast-moving images may show noise as a mosaic.
- Before and after cue/review playback, the screen may become blue for a moment or images may be disturbed.

### ■ To adjust the speaker volume during playback

- 1 Move the [-VOL+] lever to adjust the volume.

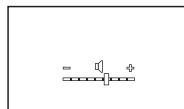
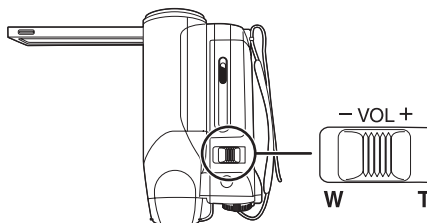

Towards [+]: increases the volume  
Towards [-]: decreases the volume

- If you do not hear the sound, check the settings of [SETUP] >> [12bit AUDIO].

### ■ Repeat playback

When the tape end is reached, the tape will be rewound and played back again.

- 1 Set [ADVANCED] >> [REPEAT PLAY] >> [ON].

- The [↺▶] indication appears. (In order to cancel the repeat playback mode, set [REPEAT PLAY] >> [OFF] or turn off the power.)

### ■ Settings on the audio

- If you cannot listen to the desired audio when playing back a tape, check the settings in [SETUP] >> [12bit AUDIO].
- When you record the audio in [12bit] and set [SETUP] >> [12bit AUDIO] >> [MIX], the audio will be played back in stereo sound regardless of the settings in [AUDIO OUT].

## Frame-by-frame playback

### ● Set to Tape Playback Mode.

- 1 During playback, move the joystick up to select the [▶/||] icon to pause playback.



- 2 Push the [-VOL+] lever.

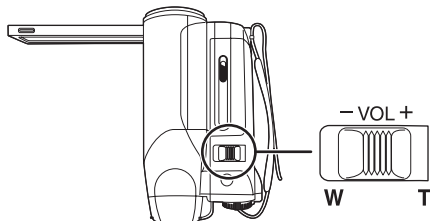

Towards [T]: normal direction  
Towards [W]: reversed direction

- If you keep pushing the lever, then the images will continuously be played back frame by frame.
- The pause icon appears for an instant. Continuous frame-by-frame playback will start after the pause icon disappears.

### ■ To return to normal playback

Move the joystick up to select the [▶/||] icon to start playback.



## Playback on TV

Images recorded by this Camcorder can be played back on a TV.

- Insert a recorded tape into this Camcorder.
- Be sure that the power of the unit is turned off before connecting it to a TV.

- 1 Connect the Camcorder and a TV.

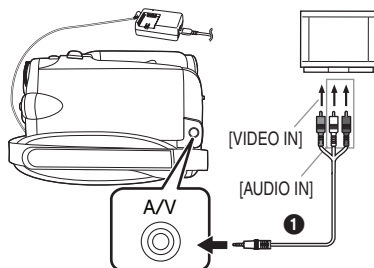

- Connect the Camcorder and a TV by using the AV cable ①.

- 2 Turn on this Camcorder and set the mode dial to the Tape Playback Mode.

- 3 Select the video input that this unit is connected to.

- If the images are not played back correctly on the TV (e.g. they are displayed vertically), perform the menu operations in accordance with the aspect ratio of the TV monitor. Set [SETUP] >> [TV ASPECT] >> [16:9] or [4:3].

- 4 Move the joystick up to select the [▶/||] icon to start playback.

- The image and audio are output on the TV.

- 5 Move the joystick down to select the [■] icon to stop playback.

- Use the AC adaptor to free you from worrying about the battery running down.

### ■ If the image or audio from this Camcorder does not appear on the TV

- Check the connections.
- Check that the plugs are inserted as far as they go.
- Check the [12bit AUDIO] settings. (-41-)
- Check the TV's input setting (input switch). (For more information, please read the operating instructions for the TV.)

## Edit mode

### Copying onto a DVD recorder or a VCR (Dubbing)

Pictures recorded by the Camcorder can be stored on a DVD-RAM disc or other such media. Refer to the instructions for the recorder.

- Place a recorded cassette in the Camcorder, and an unrecorded DVD-RAM disc or cassette in the DVD recorder or VCR.

#### 1 Connect the Camcorder and the recorder.

##### Connecting with the AV cable

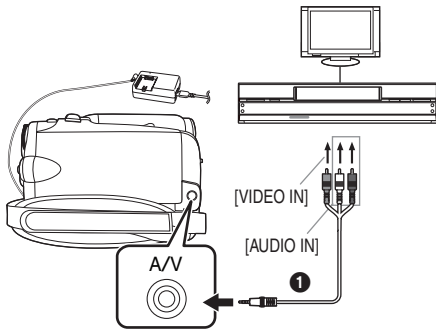

- Connect the Camcorder and the recorder by using the AV cable ①.

##### Connecting with the optional DV cable: PV-DDC9/PV-DDC9-K (Only for equipment with a DV terminal)

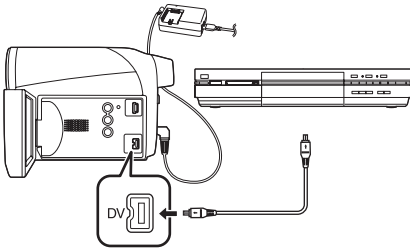

- 2 Turn on the Camcorder and set to Tape Playback Mode.
- 3 Select the input channel on the TV set and recorder.
- 4 Move the joystick up to select the [▶/||] icon to start playback. (Player)
  - The image and sound are reproduced.
- 5 Start recording. (Recorder)
- 6 Stop recording. (Recorder)

#### 7 Move the joystick down to select the [■] icon to stop playback. (Player)

- If you record (dub) images onto another video device and then play them back on a wide-screen TV, the images may be stretched vertically. In this case, refer to the operating instructions for the device that you are recording (dubbing) to or read the operating instructions for the TV and set to 16:9 (full).
- For more information, refer to the operating instructions for your TV set and recorder.
- When you do not need functional indications or date and time indication, respectively set [SETUP] >> [DISPLAY] >> [OFF] or set [BASIC] >> [DATE/TIME] >> [OFF] in the Tape Playback Mode.  
(When you connect the Camcorder and a recorder with the DV cable, these indications may not appear.)

#### ■ When neither image nor sound from the Camcorder is output to the TV set

- Check that the plugs are inserted as far as they go.
- Check the [12bit AUDIO] settings. (-41-)
- Check the connections.

## Using the DV Interface Cable for Recording (Digital Dubbing)

By connecting other digital video equipment with DV terminal and the Camcorder by using the DV cable PV-DDC9/PV-DDC9-K (optional) ❶, high-image-quality dubbing can be done in digital format.

### ● Set to Tape Playback Mode. (Player/recorder)

#### 1 Connect the Camcorder and digital video equipment with the DV cable.

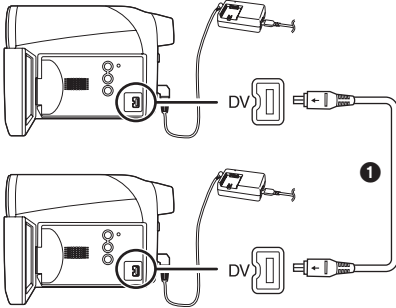

#### 2 Set [ADVANCED] >> [REC STDBY] >> [YES]. (Recorder)

#### 3 Start playback. (Player)

#### 4 Start recording. (Recorder)

Move the joystick up to select [●/II] icon.

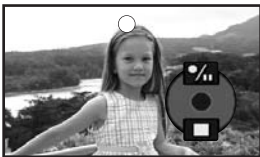

#### 5 Move the joystick up to select the [●/II] icon again to stop recording. (Recorder)

#### 6 Stop playback. (Player)

### ■ To cancel the standby for recording

When the Camcorder is standby for recording, move the joystick down and select the [■] icon.

- Do not plug or unplug the DV cable during dubbing, or the dubbing may not be completed properly.
- If a picture (bilingual video, etc.) containing main sound and sub sound has been dubbed, select the desired sound by [SETUP] >> [AUDIO OUT] on playback.

- Even if you use a device equipped with DV terminals such as IEEE1394, you may not be able to perform digital dubbing in some cases. For more information, see the instructions for equipment connected.
- Regardless of the menu settings on the recorder, digital dubbing is carried out in the same mode as the [AUDIO REC] mode of the playback tape.
- The images on the recorder monitor may be disturbed, but it does not affect the recorded images.
- If a picture containing a copyright protection signal (copy guard) is recorded by the Camcorder, the picture is distorted by mosaic-like patterns at playback.
- While pictures are input from the DV terminal, the operation icon blinks on instead of appearing from the side of the screen when you press the center of the joystick.
- While pictures are input from the DV terminal, the TV aspect will not change even if you change the setting for [TV ASPECT] in the [SETUP] menu.

#### **CAUTION:**

Unauthorized exchanging and/or copying of copyrighted recordings may be copyright infringement.

## PC Connection with the DV Interface Cable

A video clip can be transferred directly to your PC via a DV Interface Cable (optional) **A** using products and software from a number of video editing software companies.

Using products from video editing software companies allows you to capture and edit video clips using the DV Interface.

**Panasonic DVC are OHCI compliant and should have no problem working with any OHCI compliant FireWire Video — Editing software package.**

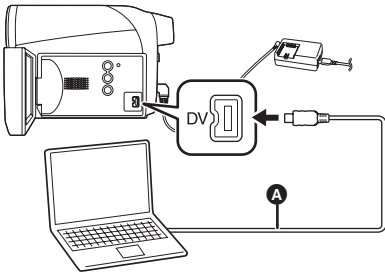

- PC must be equipped with a DV Terminal.
- During Camcorder playback, do not disconnect the DV Interface Cable or turn the Camcorder off as this may cause a PC hang-up error.
- IEEE1394 Interface must conform to OHCI (Open Host Controller Interface Specification).

## Using on Macintosh

### ■ Operating environment on iMovie HD

#### OS:

Mac OS X v 10.4

#### CPU:

PowerPC G5, Intel Core Duo, Intel Core Solo

#### Interface:

DV (FireWire) terminal (IEEE1394.a)

- iMovie HD, included with any new Macintosh or sold with iLife.

#### 1 Set the Camcorder to Tape Playback Mode.

#### 2 Connect the Camcorder to your Macintosh with the DV Interface Cable (optional).

- For more information, please contact Apple Inc. at <http://www.apple.com>.

## Notes

- Microsoft®, Windows®, Windows Vista® and DirectX® are either registered trademarks or trademarks of the Microsoft Corporation in the United States and/or other countries.
- Intel®, Core™ and Pentium® are either registered trademarks or trademarks of Intel Corporation in the United States and/or other countries.
- Apple, Mac OS, iMovie HD, FireWire are either registered trademarks or trademarks of Apple Inc. in the United States and/or other countries.
- All other names, company names, product names, etc. in these instructions are the trademarks or registered trademarks of their respective corporations.
- Microsoft product screen shot(s) reprinted with permission from Microsoft Corporation.
- The names of the products you are using may differ from the names given in the text. Depending on the operating environment and other factors, the contents of the screens used in these instructions may not necessarily match what you will see on your screen.
- Although the screens in these Operating Instructions are shown in English for the sake of example, other languages are supported as well.
- These instructions do not cover the basic operations of the PC or define any terms. For this information, refer to the Operating Instructions which accompany your PC.
- We recommend using the AC adaptor as the power source for the Camcorder when connecting to the PC. Data may be lost if the battery power is lost while transferring data.

## Menu

### Menu list

Menu figures and illustrations are provided for easy-to-understand explanations, and so they are different from the actual menu indications.

#### ■ [TAPE RECORDING MENU]

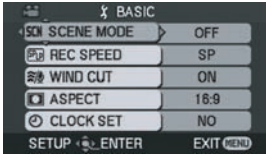

- 1) [BASIC]
  - [SCENE MODE] -32-
  - [REC SPEED] -23-
  - [WIND CUT] -29-
  - [ASPECT] -30-
  - [CLOCK SET] -15-
- 2) [ADVANCED]
  - [GUIDE LINES] -30-
  - [FADE COLOR] -29-
  - [AUDIO REC] -41-
  - [D.ZOOM] -27-
  - [ZOOM MIC] -27-
  - [SHTR EFFECT] -26-
  - [AUTO SLW SHTR] -31-
- 3) [SETUP]
  - [DISPLAY] -41-
  - [DATE/TIME] -41-
  - [POWER SAVE] -24-
  - [QUICK START] -17-
  - [BEEP SOUND] -41-
  - [LCD SET] -21-
  - [EVF SET] -21-
  - [INITIAL SET] -41-
  - [DEMO MODE] -41-
- 4) [LANGUAGE] -20-

#### ■ [TAPE PLAYBACK MENU]



- 1) [BASIC]
  - [DATE/TIME] -41-
- 2) [ADVANCED]
  - [REC SPEED] -23-
  - [REC STDBY] -38-
  - [REPEAT PLAY] -35-
- 3) [SETUP]
  - [12bit AUDIO] -41-
  - [AUDIO OUT] -41-
  - [DISPLAY] -41-
  - [LCD SET] -21-
  - [EVF SET] -21-
  - [POWER SAVE] -24-
  - [TV ASPECT] -36-
- 4) [LANGUAGE] -20-



## Menus related to recording

### ■ [DATE/TIME]

This switches between date and time indications.

- The Camcorder automatically records the date and time the picture was taken on the tape.

### ■ [AUDIO REC]

Switches the audio (PCM audio) recording systems.

[12bit]: Records audio in "12 bit 32 kHz 4 tracks".  
(The original sound recorded is preserved after audio dubbing.)

[16bit]: Records audio in "16 bit 48 kHz 2 tracks".  
Audio can be recorded in higher quality.  
(The original sound recorded is erased after audio dubbing.)

- Audio dubbing cannot be performed on this unit. If you want to edit the sound on a model with an audio dubbing function, set [12bit] to take pictures.

### ■ [DISPLAY]

Set to [ON] and the display mode can be switched to all functions. Set to [OFF] and it can be switched to minimum display.

### ■ [BEEP SOUND]

Set to [ON] and confirmation/alarm beeps are issued as follows.

1 Beep

- When you start recording
- When you turn on the power
- When the unit goes from quick start standby mode to recording pause

2 Beeps

- When you pause recording
- When you turn off the power
- When the unit goes into quick start standby mode

2 Beeps for 4 times

- When a cassette with its erasure prevention tab set to [SAVE] is inserted, condensation occurs (-46-), and at other times. Check the sentence displayed on the screen. (-42-)

## Menus related to playback

### ■ [12bit AUDIO]

If you want to edit the sound on a model with an audio dubbing function, set [12bit] to take pictures.

You can switch the sound (PCM Audio) when playing back a tape with sound recorded in [12bit].

[ST1]: It only plays back the original sound recorded.

[ST2]: It only plays back the sound on the tape added with audio dubbing.

[MIX]: It simultaneously plays back both [ST1] and [ST2] sounds.

- Audio dubbing cannot be performed on this unit. When playing back a tape recorded on this unit, you will not be able to hear the sound if [ST2] is set. Set [ST1].

### ■ [AUDIO OUT]

This switches the sound to be played back.

[STEREO]: Stereo sound (main sound and sub sound)

[L]: Left channel sound (main sound)

[R]: Right channel sound (sub sound)

## Other menus

### ■ [INITIAL SET]

When there is a menu that cannot be selected depending on a combination of functions, set to [YES] for changing the menu settings back to the default condition.

(Language setting cannot be back to the default condition.)

### ■ [DEMO MODE]

If you set to [DEMO MODE] >> [ON] without inserting a cassette, the Camcorder is automatically set to the demonstration mode for introducing its functions. If any button is pressed or operated, the demonstration mode is canceled. If no operations take place for approx.

10 minutes, the demonstration mode automatically starts. To terminate the demonstration mode, insert a cassette, or set to [DEMO MODE] >> [OFF]. For normal use, set this function to [OFF].

## Others

### Indications

Various functions and the Camcorder status are shown on the screen.

#### Basic indications

- : Remaining battery power  
 0h00m00s00f: Time code  
 3:30:45PM Date/Time indication

#### Recording indications

- R0:45: Remaining tape time
- Remaining tape time is indicated in minutes. (When it reaches less than 3 minutes, the indication starts flashing.)
- SP: Standard Play mode (Recording speed mode) -23-
- LP: Long Play mode (Recording speed mode) -23-
- Recording -24-
- || (Green): Recording pause -24-
- || (Green flash): Standby mode
- || (Red): Fade out
- : Recording check -25-
- : Wide -30-
- : Automatic mode -23-
- : Manual mode -32-
- MF: Manual focus -33-
- 5×: Zoom magnification indication -26-
- : Backlight mode -27-
- : Optical Image Stabilizer -30-
- 1/500: Shutter speed -34-
- F2.4: F number -34-
- 6dB: Gain value -34-
- : Soft skin mode -28-
- : Fade (White) -29-
- : Fade (Black) -29-
- : Blank search -25-
- : MagicPix function -28-
- : Video Light is on -22-
- : Zoom microphone -27-
- : Wind noise reduction -29-
- : Sports mode (Scene mode) -32-
- : Portrait mode (Scene mode) -32-
- : Low light mode (Scene mode) -32-
- : Spotlight mode (Scene mode) -32-
- : Surf & snow mode (Scene mode) -32-
- : Auto white balance -33-
- : Indoor mode (recording under incandescent lamp) -33-
- : Outdoor mode -33-

- : White balance adjustment mode -33-

#### Playback indications

- : Recording underway
- ▶ : Playback -35-
- || : Pause -35-
- ▶▶ : Fast forward/Cue playback -35-
- ◀◀ : Rewind/Review playback -35-
- ||▶/◀|| : Frame-by-frame playback -36-
- 🔄▶ : Repeat playback -35-
- 12bit, 16bit: Audio recording mode -41-
- : Volume adjustment -35-

### Warning/alarm indications

If any one of the following indications lights up or flashes, please check the Camcorder.

#### Confirmatory indications

- : A cassette with the accidental erasure prevention slider placed in the [SAVE] position is inserted.  
 No cassette is inserted.
- [--]/ : The built-in battery is low. -15-
- : The warning/alarm indication appears when you record yourself. Turn the LCD monitor towards the viewfinder and check the warning/alarm indication.

#### END:

- The tape came to the end during recording.
- : The video heads are dirty. -46-

#### Textual indications

- DEW DETECT/ EJECT TAPE:  
 Condensation has occurred. Take out the cassette and wait for a while. It takes some time until the cassette holder opens, but this is not a malfunction. -46-
- LOW BATTERY:  
 The battery is low. Recharge it. -12-
- NO TAPE :  
 No tape is inserted. -18-
- TAPE END:  
 The tape came to the end during recording.
- CHECK REC TAB:  
 You are attempting to record pictures on a tape with the accidental erasure prevention slider placed in the [SAVE] position.  
 You are attempting digital dubbing on a tape with the accidental erasure prevention slider placed in the [SAVE] position.

**WRONG TAPE FORMAT:**

You are attempting to play back a tape section that has been recorded with a different TV system. This cassette is incompatible.

**CLOSE CASSETTE DOOR:**

The cassette cover is open. Close the cassette cover. -18-

**COPY PROTECTED:**

Images cannot be recorded correctly because the medium is protected by a copy guard.

**NEED HEAD CLEANING:**

The video heads are dirty. -46-

**PUSH THE RESET SWITCH:**

An irregularity in the equipment has been detected. Press the [RESET] button (-45-). This may solve the problem.

**CHANGE TO MANUAL MODE:**

You are attempting to select the item on the [SCENE MODE] when the Camcorder is set to [AUTO].

***Functions that cannot be used simultaneously***

Some functions in the Camcorder are disabled or cannot be selected due to its specifications. The table below shows examples of functions restricted by conditions.

Functions	Conditions which disable the functions
<ul style="list-style-type: none"> <li>● Backlight compensation</li> </ul>	<ul style="list-style-type: none"> <li>● When the MagicPix function is used</li> <li>● When the iris/gain is set</li> </ul>
<ul style="list-style-type: none"> <li>● Help mode</li> <li>● Recording check</li> <li>● Blank search</li> <li>● Soft skin</li> <li>● MagicPix</li> </ul>	<ul style="list-style-type: none"> <li>● While recording to a tape</li> </ul>
<ul style="list-style-type: none"> <li>● Scene mode</li> </ul>	<ul style="list-style-type: none"> <li>● When the Camcorder is set to [AUTO]</li> <li>● When the MagicPix function is used</li> <li>● When the built-in LED video light is on</li> </ul>
<ul style="list-style-type: none"> <li>● Change of white balance</li> </ul>	<ul style="list-style-type: none"> <li>● When digital zoom (42× or higher) is used</li> <li>● When the MagicPix function is used</li> </ul>
<ul style="list-style-type: none"> <li>● Adjusting the shutter speed, iris/gain</li> </ul>	<ul style="list-style-type: none"> <li>● When the MagicPix function is used</li> <li>● When the scene mode is used</li> </ul>

## **Before requesting repair (Problems and solutions)**

### **Power/Body**

#### **1: The Camcorder power cannot be turned on.**

- Is the battery fully charged? Use a fully charged battery.
- The battery protection circuit may have operated. Insert the battery to the AC adaptor for 5 to 10 seconds. If the Camcorder still cannot be used, the battery is faulty.
- Make sure the LCD monitor is opened or the viewfinder extended.

#### **2: The Camcorder power is turned off automatically.**

- If you do not use the unit for approximately 5 minutes, the power is automatically turned off to conserve battery life. To resume recording, turn the power back on. The power will not turn off automatically when the power save function is set to [OFF]. (-24-)

#### **3: The Camcorder power does not stay on long enough.**

- Is the battery low? If the remaining battery power indication is flashing or the message "LOW BATTERY" is displayed, the battery has run down. Charge the battery or attach a fully charged battery. (-12-)
- Has condensation occurred? When you carry the Camcorder from a cold place into a warm place, condensation may occur inside it. If so, the power is turned off automatically, disabling all operations except for taking cassettes out. Wait until the condensation indication disappears. (-46-)

#### **4: Battery runs down quickly.**

- Is the battery fully charged? Charge it with the AC adaptor. (-12-)
- Are you using the battery in an extremely cold place? The battery is affected by ambient temperature. In cold places, the operating time of the battery becomes shorter.
- Has the battery worn out? The battery has a limited life. If the operating time is still too short even after the battery is fully charged, depending on the usage, the battery has worn out and needs to be replaced.

#### **5: The Camcorder cannot be operated though powered up.**

##### **The Camcorder does not operate normally.**

- The Camcorder cannot be operated unless you open the LCD monitor or extend the viewfinder.
- Remove the cassette and then press the [RESET] button. (-45-) If normal conditions are not restored yet, turn off the power. Then, about 1 minute later, turn on the power again.

#### **6: The cassette cannot be removed.**

- Does the status indicator comes on when opening the cassette cover? (-18-) Make sure that the battery and the AC adaptor are properly connected. (-12-)
- Is the battery in use discharged? Charge the battery and remove the cassette.
- Close the cassette cover completely, and fully open it again. (-18-)

#### **7: No operation other than cassette removal can be performed.**

- Has condensation occurred? Wait until the condensation indication disappears. (-46-)

### **Recording**

#### **1: Recording does not start although power is supplied to the Camcorder and the cassette is correctly inserted.**

- Is the accidental erasure prevention slider on the cassette open? If it is open (set to [SAVE]), recording cannot be performed. (-18-)
- Is the tape wound to the end? Insert a new cassette.
- Is the recording mode set? When in the playback mode, recording cannot be performed. (-14-)
- Has condensation occurred? No operation other than cassette removal can be performed when condensation occurs. Wait until the condensation indication disappears. (-46-)
- Is the cassette cover open? If the cover is open, the Camcorder may not operate normally. Close the cassette cover. (-18-)

#### **2: The screen has changed suddenly. ([DEMO MODE] is on)**

- Has the demonstration started? In the Tape Recording mode, if you set [DEMO MODE] >> [ON] without inserting a cassette, the demonstration starts. For normal use, set this function to [OFF]. (-41-)

#### **3: A cassette cannot be inserted.**

- Has condensation occurred? Wait until the condensation indication disappears.

#### **4: Auto focus function does not work.**

- Is manual focus mode selected? If auto focus mode is selected, focus is automatically adjusted.
- There are some recording subjects and surroundings for which the auto focus does not operate correctly. (-49-) If so, use the manual focus mode to adjust the focus. (-33-)

### **Indications**

#### **1: A sentence is displayed in red in the screen center.**

- Read the contents and respond to them. (-42-)

## 2: The remaining tape time indication disappears.

- The remaining tape time indication may disappear temporarily during frame-by-frame playback or other operation. If you continue ordinary recording or playback, the indication is restored.

## 3: The remaining tape time indication does not match the actual remaining tape time.

- If scenes of less than 15 seconds are continuously recorded, the remaining tape time cannot be correctly displayed.
- In some cases, the remaining tape time indication may show remaining tape time that is 2 to 3 minutes shorter than the actual remaining tape time.

## 4: The function indications such as the mode indication or the remaining tape time indication are not shown.

- If you set [SETUP] >> [DISPLAY] >> [OFF], all indications other than the tape running condition, warning, and date are not displayed.

### Playback (Sound)

#### 1: Sound is not played back from the built-in speaker of the Camcorder.

- Is the volume too low? During playback, push the [-VOL+] lever to display the volume indication and adjust it. (-35-)

#### 2: Different sounds are reproduced at the same time.

- Have you set [SETUP] >> [AUDIO OUT] >> [STEREO] and reproduced a picture containing the main sound and sub sound? Set to [L] to hear main sound, and set to [R] to hear the sub sound. (-41-)

### Playback (Pictures)

#### 1: Although the Camcorder is correctly connected to a TV, playback images cannot be seen. The playback images are vertical.

- Have you selected video input on the TV? Please read the operating instructions of your TV and select the channel that matches the input terminals used for the connection.
- Is the [TV ASPECT] setting correct? Change the setting to match the aspect ratio of the TV. [SETUP] >> [TV ASPECT] >> [16:9] or [4:3].

#### 2: Mosaic-pattern noise appears on images during cue or review playback.

- This phenomenon is characteristic of digital video systems. It is not a malfunction.

#### 3: Horizontal stripes appear on images during cue and review playback.

- Horizontal stripes may appear depending on the scene, but this is not a malfunction.

## 4: Playback picture is not clear.

- Are the heads of the Camcorder dirty? If the heads are dirty, playback image cannot be clear. Clean the heads by using the head cleaner for digital video (optional). (-46-)
- If the terminal for the AV cable is soiled, noises may appear on the screen. Wipe the soil off the terminal with a soft cloth, and then connect the cable to the A/V terminal.
- Is a picture containing a copyright protection signal (copy guard) being recorded? When a protected picture is played back by the Camcorder, mosaic-like patterns appear on the picture.

### Others

#### 1: The indication disappears, the screen is frozen, or no operation can be performed.

- Turn off the power to the Camcorder. If the power cannot be turned off, press the [RESET] button, or detach the battery or AC adaptor and then reattach it. Turn on the power again. If normal operation is still not restored, detach the power connected, and contact Panasonic. (-55-)

#### 2: "PUSH THE RESET SWITCH" is displayed.

- An irregularity in the Camcorder has been automatically detected. Remove the cassette for data protection and then press the [RESET] button with the boss **A**. The Camcorder will be activated.

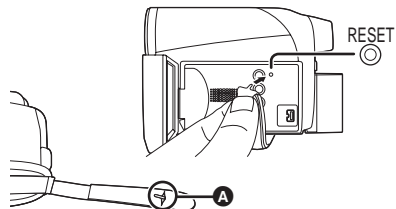

- If you do not press the [RESET] button, the power to the Camcorder is turned off automatically about 1 minute later.
- Even after you press the [RESET] button, the indication may still appear repeatedly. If so, the Camcorder needs repair. Detach the power connected, and contact Panasonic. (-55-)

## Cautions for Use

### About condensation

If you turn the Camcorder on when condensation occurs on the head or the tape, condensation indication [ ] (yellow or red) is displayed on the viewfinder or the LCD monitor and the messages [ ] DEW DETECT or [ ] EJECT TAPE (only when the tape is inserted) appear. If so, follow the procedure below.

#### 1 Remove the tape if it is inserted.

- It takes about 20 seconds to open the cassette holder. This is not a malfunction.

#### 2 Leave the Camcorder with the cassette cover closed and the battery attached, to cool or warm it to the ambient temperature.

- The status indicator blinks for about 1 minute and then the Camcorder automatically turns off. Leave it for about 1.5 to 2 hours.

#### 3 Turn the Camcorder on again, set it to the Tape Recording/Playback Mode and then check if the condensation indication disappears.

Especially in cold areas, moisture may be frozen. If so, it may take more time before the condensation indication disappears.

#### Watch for condensation even before the condensation indication is displayed.

- If the indicator of the condensation does not display on the LCD screen and/or EVF and you notice condensation on the lens or the main unit, do not open the cassette cover otherwise condensation may be formed on the heads or the cassette tape.

### About dirty heads

If video heads (the parts that closely contact with the tape) become dirty, normal recording and playback are not properly performed. Clean the heads with the digital video head cleaner.

- Insert the head cleaner into the Camcorder, set it to the Tape Playback Mode, and play it back for about 10 seconds. (If you do not stop the playback, it automatically stops about 15 seconds later.)
- We recommend cleaning the heads periodically. If the heads become dirty, "NEED HEAD CLEANING" appears during recording. During playback, moreover, the following symptoms appear.

- Mosaic-like noise appears partially or the sound is interrupted.
- Black or blue mosaic-like horizontal stripes appear.

- The whole screen becomes blue and there is no picture or sound.

#### When normal playback cannot be performed even after the head cleaning

One possible cause is that normal recording could not be performed because the heads were dirty at the time of recording. Clean the heads, and perform recording and playback again. If normal playback can be performed, the heads are clean. Before an important recording, be sure to conduct a test recording to make sure that normal recording can be performed.

- If the heads become dirty soon after cleaning, the problem may be the tape. If so, try another cassette.
- During playback, the picture or sound may be interrupted momentarily, but this is not a malfunction of the Camcorder. (One possible cause is that the playback is interrupted by dirt or dust that momentarily adheres to the heads.)

### About the Camcorder

- When the Camcorder is used for a long time, the Camcorder body becomes warm, but this is not a malfunction.

#### Keep the Digital Video Camcorder as far away as possible from electromagnetic equipment (such as microwave ovens, TVs, video games etc.).

- If you use the Digital Video Camcorder on top of or near a TV, the pictures and sound on the Digital Video Camcorder may be disrupted by electromagnetic wave radiation.
- Do not use the Digital Video Camcorder near cell phones because doing so may result in noise adversely affecting the pictures and sound.
- Recorded data may be damaged, or pictures may be distorted, by strong magnetic fields created by speakers or large motors.
- Electromagnetic wave radiation generated by microprocessors may adversely affect the Digital Video Camcorder, disturbing the pictures and sound.
- If the Digital Video Camcorder is adversely affected by electromagnetic equipment and stops functioning properly, turn the Digital Video Camcorder off and remove the battery or disconnect AC adaptor. Then reinsert the battery or reconnect AC adaptor and turn the Digital Video Camcorder on.

#### Do not use the Digital Video Camcorder near radio transmitters or high-voltage lines.

- If you record near radio transmitters or high-voltage lines, the recorded pictures and sound may be adversely affected.

**Do not spray insecticides or volatile chemicals onto the Camcorder.**

- If the Camcorder is sprayed with such chemicals, the Camcorder body may become deformed and the surface finish may peel off.
- Do not keep rubber or plastic products in contact with the Camcorder for a long time.

**When you use your Camcorder in a sandy or dusty place such as on a beach, do not let sand or fine dust get into the body and terminals of the Camcorder. Also, protect the Camcorder from getting wet.**

- Sand or dust may damage the Camcorder or cassette. (Care should be taken when inserting and removing a cassette.)
- If sea water splashes onto the Camcorder, wet a soft cloth with tap water, wring it well, and use it to wipe the Camcorder body carefully. Then, wipe it again thoroughly with a soft dry cloth.

**While carrying the Camcorder, do not drop or bump it.**

- A strong impact on the Camcorder may break its housing, causing it to malfunction.

**Do not use benzine, paint thinner or alcohol for cleaning the Camcorder.**

- Before cleaning, detach the battery or pull out the AC Cable from the AC Jack.
- The Camcorder body may be discolored and the surface finish may peel off.
- Wipe the Camcorder with a soft dry cloth to remove dust and fingerprints. To remove stubborn stains, wring well a cloth that is soaked in a neutral detergent diluted with water and wipe the Camcorder with it. Afterwards, wipe it with a dry cloth.
- When you use a chemical dust cloth, follow the instructions.

**Do not use this Camcorder for surveillance purposes or other business use.**

- If you use the Camcorder for a long time, the internal temperature increases and, consequently, this may cause malfunction.
- This Camcorder is not intended for business use.

**When you are not going to use Camcorder for an extended time**

- When storing the unit in a cupboard or a cabinet, it is recommended that you put a desiccant (silica gel) in with it.

**■ About the battery**

The battery used in the Camcorder is a rechargeable lithium ion battery. This battery is susceptible to temperature and humidity, and the effect of temperature increases with increasing or decreasing temperature. In the low temperature range, the fully charged indication may not appear, or the low battery indication may appear about 5 minutes after the start of use. At high temperature, moreover, the protection function may work, disabling use of the Camcorder.

**Be sure to detach the battery after use.**

- If the battery is left attached to the Camcorder, a minute amount of current is consumed even when the Camcorder power is OFF. If the battery is left attached to the Camcorder for a long time, over-discharge takes place. The battery may become unusable after it is charged.
- The battery should be stored in a cool place free from humidity, with as constant temperature as possible. (Recommended temperature: 15 °C to 25 °C (59 °F to 77 °F), Recommended humidity: 40% to 60%)
- Extremely high temperatures or low temperatures will shorten the life of the battery.
- If the battery is kept in a high-temperature, high-humidity, or oily-smoky places, the terminals may rust and cause malfunctions.
- To store the battery for a long period of time, we recommend you charge it once every year and store it again after you have completely used up the charged capacity.
- Dust and other matter attached to the battery terminals should be removed.

**Prepare spare batteries when going out for recording.**

- Prepare batteries appropriate to 3 to 4 times the period you are planning to record for. Cold places such as a ski resort, can shorten the period during which you can record for.

**If you drop the battery accidentally, check to see if the terminals are deformed.**

- Attaching a deformed battery to the Camcorder or AC adaptor may damage the Camcorder or AC adaptor.

**Do not throw old battery into fire.**

- Heating a battery or throwing it into a fire may result in an explosion.

**If the operating time is very short even after the battery has been recharged, the battery has worn out. Please purchase a new battery.**

## ■ About the AC adaptor

- If the battery is warm, charging requires more time than normal.
- If the temperature of the battery is extremely high or extremely low, the [CHARGE] lamp may continue flashing, and the battery may not be charged. After the battery temperature has decreased or increased sufficiently, recharging starts automatically. So, wait for a while. If the lamp still continues flashing even after the recharging, the battery or AC adaptor may be faulty. If so, please contact a dealer.
- If you use the AC adaptor near a radio, radio reception may be disturbed. Keep the AC adaptor 1 m (3.3 feet) or more away from radio.
- When using the AC adaptor, it may generate whirring sounds. However, this is normal.
- After use, be sure to pull out the AC Cable from the AC Jack. (If they are left connected, a minute amount of current is consumed.)
- Always keep the electrodes of the AC adaptor and battery clean.

## ■ About the cassette

**Never place the cassette in a high temperature place.**

- The tape may be damaged, producing mosaic-like noise at the time of playback.

**When storing the cassette after use, be sure to rewind the tape to the beginning and take it out.**

- If the cassette is left for more than 6 months (depending on the storage condition) in the Camcorder or stopped midway, the tape may sag and be damaged.
- Once every 6 months, wind the tape to the end and then rewind it to the beginning. If the cassette is left for 1 year or longer without winding or rewinding, the tape may be deformed by expansion or shrinkage attributable to temperature and humidity. The wound tape may stick to itself.
- Dust, direct sunlight (ultraviolet rays), and humidity may damage the tape. Such usage may cause damage to the Camcorder and the heads.
- After use, be sure to rewind the tape to the beginning, put the cassette in the case to protect it from dust, and store it upright.

**Keep the cassette away from strong magnetism.**

- Apparatus using magnets such as magnetic necklaces and toys have a magnetic force that is stronger than expected, and they may erase the contents of a recording or may increase noise.

## ■ LCD monitor/viewfinder

### LCD monitor

- When the LCD monitor gets dirty, wipe it with a dry soft cloth.
- In a place with drastic temperature changes, condensation may form on the LCD monitor. Wipe it with soft dry cloth.
- If your Camcorder is extremely cold, the LCD monitor is slightly darker than usual immediately after you turn the power on. However, as the internal temperature increases, it goes back to normal brightness.

Extremely high precision technology is employed to produce the LCD monitor screen featuring a total of approximately 123,000 pixels. The result is more than 99.99% effective pixels with a mere 0.01% of the pixels inactive or always lit. However, this is not a malfunction and does not affect the recorded picture.

### Viewfinder

Extremely high precision technology is employed to produce the viewfinder screen featuring a total of approximately 113,000 pixels. The result is more than 99.99% effective pixels with a mere 0.01% of the pixels inactive or always lit. However, this is not a malfunction and does not affect the recorded picture.

## ■ Periodical check-ups

- To maintain the highest image quality, we recommend replacing worn parts such as heads after approx. 1000 hours of use. (This, however, depends on operating conditions including temperature, humidity and dust.)



## Explanation of terms

### Automatic white balance

White balance adjustment recognizes the color of light and adjusts so the white color will become a pure white. The Camcorder determines the hue of light that comes through the lens and white balance sensor, thereby judging the recording condition, and selects the closest hue setting. This is called automatic white balance adjustment. However, since the Camcorder only stores white color information under several light sources, automatic white balance adjustment does not function normally under the other light sources.

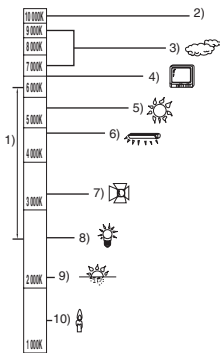

Outside of the effective range of automatic white balance adjustment, the image will become reddish or bluish. Even within the effective range of automatic white balance adjustment, the automatic white balance adjustment may not function properly if there is more than one light source. For light outside the functional auto white balance adjustment range, use the manual white balance adjustment mode.

- 1) The effective range of automatic white balance adjustment on this Camcorder
- 2) Blue sky
- 3) Cloudy sky (rain)
- 4) TV screen
- 5) Sunlight
- 6) White fluorescent lamp
- 7) Halogen light bulb
- 8) Incandescent light bulb
- 9) Sunrise or sunset
- 10) Candlelight

### White balance adjustment

White balance adjustment determines the white color under different light sources. By recognizing which is the white color under sunlight and which is the white color under a fluorescent lamp, the Camcorder can adjust the balance among the other colors.

Since white is the reference of all colors, the Camcorder can record pictures in a natural hue if it can recognize the reference white color.

### Auto focus

Auto focus automatically moves the focusing lens forward and backward inside the Camcorder to bring the subject into focus.

**Auto focus has the following characteristics.**

- Adjusts so that the vertical lines of a subject are seen more clearly.
- Attempts to bring an object with higher contrast into focus.
- Focuses on the screen center only.

Due to these characteristics, auto focus does not work correctly in the following situations. Record pictures in the manual focus mode.

**Recording a subject with one end located closer to the Camcorder and the other end farther away from it**

- As auto focus adjusts at the center of an image, it may be impossible to focus on a subject that is located in both the foreground and background.

**Recording a subject behind dirty or dusty glass**

- The subject behind the glass will not be focused because the focus is on the dirty glass.

**Recording a subject that is surrounded by objects with glossy surfaces or by highly reflective objects**

- The recording subject may become blurry because the Camcorder focuses on the objects with glossy surfaces or on highly reflective objects.

**Recording a subject in dark surroundings**

- The Camcorder cannot focus correctly because the light information that comes through the lens decreases considerably.

**Recording a fast-moving subject**

- As the focus lens-inside moves mechanically, it cannot keep up with a fast-moving subject.

**Recording a subject with little contrast**

- A subject with little contrast, such as a white wall, may become blurry because the Camcorder achieves focus based upon the vertical lines of an image.

## Specifications

### Digital Video Camcorder

Information for your safety

**Power source:**

DC 9.3/7.2 V

**Power consumption:**

Recording

4.1 W

**Recording format:**

Mini DV (Consumer-use digital video SD format)

**Tape used:**

6.35 mm digital video tape

**Recording/playback time:**

SP: 80 min; LP: 120 min (with DVM80)

**Video**
**Recording system:**

Digital component

**Television system:**

EIA Standard: 525 lines, 60 fields NTSC color signal

**Audio**
**Recording system:**

PCM digital recording

16 bit (48 kHz/2 ch), 12 bit (32 kHz/4 ch)

**Image sensor:**

1/6-inch CCD image sensor

[Effective pixels]

Moving picture: 290 K (4:3), 380 K (16:9)/

Still picture: 290 K (4:3), 380 K (16:9)/

Total: 800 K

**Lens:**

Auto Iris, F1.9 to F4.3, Focal length; 1.8 mm to

75.6 mm, Macro (Full range AF)

**Zoom:**

42:1 Power zoom

**Monitor:**

2.7-inch LCD

**Viewfinder:**

Color electronic viewfinder

**Microphone:**

Stereo (with a zoom function)

**Speaker:**

1 round speaker  $\varnothing$  20 mm

**Standard illumination:**

1,400 lx

**Minimum required illumination:**

6 lx

2 lx (MagicPix function)

**Video output level:**

1.0 Vp-p, 75  $\Omega$

**Audio output level (Line):**

316 mV, 600  $\Omega$

**Digital interface:**

DV input/output terminal (IEEE1394, 4-pin)

**Dimensions:**

67.0 mm (W)  $\times$  84.5 mm (H)  $\times$  119.3 mm (D)

[2.638 inch (W)  $\times$  3.327 inch (H)  $\times$  4.697 inch (D)]

(excluding the projection parts)

**Mass (Weight):**

Approx. 390 g (0.86 lbs)

(without the supplied battery, DV cassette)

**Operating temperature:**

0  $^{\circ}$ C to 40  $^{\circ}$ C (32  $^{\circ}$ F to 104  $^{\circ}$ F)

**Operating humidity:**

10% to 80%

**AC adaptor**

Information for your safety

**Power source:**

AC 110 V to 240 V, 50/60 Hz

**Power consumption:**

19 W

**DC output:**

DC 9.3 V, 1.2 A (Camcorder operation)

DC 8.4 V, 0.65 A (Battery charging)

**Dimensions:**

92 mm (W)  $\times$  33 mm (H)  $\times$  61 mm (D)







[3.6 inch (W)  $\times$  1.3 inch (H)  $\times$  2.4 inch (D)]

**Mass (Weight):**

Approx. 115 g (0.25 lbs)

Specifications may change without prior notice.

## Camcorder Accessory System

Accessory No.	Figure	Description
VW-VBG130*1		1320 mAh/Rechargeable Lithium Ion Battery Pack
VW-VBG260*1		2640 mAh/Rechargeable Lithium Ion Battery Pack
VW-VBG6*1*2		5800 mAh/Rechargeable Lithium Ion Battery Pack
VW-VH04		Battery Pack Holder Kit
PV-DDC9 (For USA) PV-DDC9-K (For Canada)		DV Interface Cable (4-pin to 4-pin)
PV-HB002 (USA only)		Carrying Case

\*1 Please refer to page -I3-, concerning the battery charging time and available recording time.

\*2 The battery pack holder kit VW-VH04 (optional) is necessary.

**NOTE: Accessories and/or model numbers may vary by country. Please consult your local dealer.**

**Camcorder Accessory Order Form (For USA Customers)**

Please photocopy this form when placing an order.

1. Palmcorder Model # \_\_\_\_\_

2. Items Ordered

Accessory #	Description	Price Each	Quantity	Total Price
Subtotal				
Your State & Local Sales Tax				
Shipping & Handling				6.95
Total Enclosed				

3. Method of payment (check one)

- Check of Money Order enclosed (NO C.O.D.SHIPMENTS)
- VISA                      Credit Card # \_\_\_\_\_
- MasterCard              Expiration Date \_\_\_\_\_
- Discover                    Customer Signature \_\_\_\_\_

Make Check or Money Order Payable to: PANASONIC ACCESSORIES

(Please do not send cash)

4. Shipping information (UPS delivery requires complete street address)

Ship To:

Mr.

Mrs.

Ms.

\_\_\_\_\_

First

Last

Phone#:

Day ( ) \_\_\_\_\_

Street Address

Night ( ) \_\_\_\_\_

\_\_\_\_\_

City

State

Zip

TO OBTAIN ANY OF OUR PALMCORDER ACCESSORIES YOU CAN DO ANY OF  
THE FOLLOWING:  
VISIT YOUR LOCAL PANASONIC DEALER  
OR  
CALL PANASONIC'S ACCESSORY ORDER LINE AT 1-800-332-5368  
[6 AM-6 PM M-F, PACIFIC TIME]  
OR  
MAIL THIS ORDER TO: PANASONIC SERVICE AND TECHNOLOGY COMPANY  
ACCESSORY ORDER OFFICE  
20421 84th Avenue South Kent, WA. 98032

In CANADA, please contact your local Panasonic dealer for more information on Accessories.

---

**Request for Service Notice (USA Only)**

---

Please photocopy this form when making a request for service notice, in the unlikely event this product needs service.

**Request for Service Notice:**

- Please include your **proof of purchase.**  
(Failure to do so will delay your repair.)
- To further speed your repair, please provide an explanation of what is wrong with the unit and any symptom it is exhibiting.

---

---

---

---

Mail this completed form and your Proof of Purchase along with your unit to:  
Panasonic Camera and Digital Service Center  
1590 Touhy Ave.  
Elk Grove Village, IL 60007

## Limited Warranty (For USA Customers)

PANASONIC CONSUMER ELECTRONICS  
COMPANY, DIVISION OF PANASONIC  
CORPORATION OF NORTH AMERICA  
One Panasonic Way, Secaucus, New Jersey 07094

PANASONIC PUERTO RICO, INC.  
Ave. 65 de Infantería, Km. 9.5 San Gabriel Industrial Park,  
Carolina, Puerto Rico 00985

### Panasonic Video Products Limited Warranty

#### Limited Warranty Coverage

If your product does not work properly because of a defect in materials or workmanship, Panasonic Consumer Electronics Company or Panasonic Puerto Rico, Inc. (collectively referred to as "the warrantor") will, for the length of the period indicated on the chart below, which starts with the date of original purchase ("warranty period"), at its option either (a) repair your product with new or refurbished parts, or (b) replace it with a new or a refurbished product. The decision to repair or replace will be made by the warrantor.

Product	Parts	Labor	Service	Contact Number
Camcorder	One (1) Year (except CCD Image Sensor) CCD Image Sensor - 6 (Six) Months	Ninety (90) Days Ninety (90) Days	Carry-In or Mail-In	1-800-211-PANA(7262)
DVD/VCR Deck, A/V Mixer	One (1) Year	Ninety (90) Days	Carry-In or Mail-In	1-800-211-PANA(7262)
TV/VCR, TV/DVD, TV/DVD/VCR Combination	One (1) Year (except CRT) CRT - Two (2) Years	Ninety (90) Days Ninety (90) Days	Carry-In: 21" CRT and Smaller In-Home or Carry-In: 22" CRT and Larger	1-800-211-PANA(7262)
TV/HDR Combination	One (1) Year (except CRT) CRT - Two (2) Years	Ninety (90) Days Ninety (90) Days	In-Home or Carry-In	1-888-843-9788
Rechargeable Batteries (in exchange for defective item)	Ten (10) Days	Not Applicable	Carry-In or Mail-In	1-800-211-PANA(7262)
Tape (in exchange for defective item)	Five (5) Days	Not Applicable	Carry-In or Mail-In	1-800-211-PANA(7262)
Memory Cards (in exchange for defective item)	Ninety (90) Days	Not Applicable	Carry-In or Mail-In	1-800-211-PANA(7262)

During the "Labor" warranty period there will be no charge for labor. During the "Parts" warranty period, there will be no charge for parts. You must carry-in or mail-in (prepaid) your product or arrange for in-home service, as applicable, during the warranty period. If non-rechargeable batteries are included, they are not warranted. This warranty only applies to products purchased and serviced in the United States or Puerto Rico. This warranty is extended only to the original purchaser of a new product which was not sold "as is". A purchase receipt or other proof of the original purchase date is required for warranty service.

#### Carry-In, Mail-in (Prepaid) or In-Home Service

For Carry-In, Mail-In (prepaid) or In-Home Service (as applicable) in the United States call toll free contact number listed above or visit Panasonic Web Site: <http://www.panasonic.com>

For assistance in Puerto Rico call Panasonic Puerto Rico, Inc. (787)-750-4300 or fax (787)-768-2910.

In-Home service, if applicable, requires clear, complete and easy access to the product by the authorized servicer and does not include removal or re-installation of an installed product. It is possible that certain in-home repairs will not be completed in-home, but will require that the product, or parts of the product, be removed for shop diagnosis and/or repair and then returned.

#### Limited Warranty Limits And Exclusions

This warranty ONLY COVERS failures due to defects in materials or workmanship, and DOES NOT COVER normal wear and tear or cosmetic damage, nor does it cover markings or retained images on the picture tube resulting from viewing fixed images (including, among other things, letterbox pictures on standard 4:3 screen TV's, or non-expanded standard 4:3 pictures on wide screen TV's, or onscreen data in a stationary and fixed location). The warranty ALSO DOES NOT COVER damages which occurred in shipment, or failures which are caused by products not supplied by the warrantor, or failures which result from accidents, misuse, abuse, neglect, bug infestation, mishandling, misapplication, alteration, faulty installation, set-up adjustments, misadjustment of consumer controls, improper maintenance, power line surge, lightning damage, modification, or commercial use (such as in a hotel, office, restaurant, or other business), rental use of the product, service by anyone other than a Factory Service Center or other Authorized Servicer, or damage that is attributable to acts of God.

**THERE ARE NO EXPRESS WARRANTIES EXCEPT AS LISTED UNDER "LIMITED WARRANTY COVERAGE". THE WARRANTOR IS NOT LIABLE FOR INCIDENTAL OR CONSEQUENTIAL DAMAGES RESULTING FROM THE USE OF THIS PRODUCT, OR ARISING OUT OF ANY BREACH OF THIS WARRANTY.**

(As examples, this excludes damages for lost time, cost of having someone remove or re-install an installed unit if applicable, or travel to and from the servicer, loss of media or images, data or other memory or recorded content. The items listed are not exclusive, but are for illustration only.)

**ALL EXPRESS AND IMPLIED WARRANTIES, INCLUDING THE WARRANTY OF MERCHANTABILITY, ARE LIMITED TO THE PERIOD OF THE LIMITED WARRANTY.**

Some states do not allow the exclusion or limitation of incidental or consequential damages, or limitations on how long an implied warranty lasts, so the exclusions may not apply to you. This warranty gives you specific legal rights and you may also have other rights which vary from state to state. If a problem with this product develops during or after the warranty period, you may contact your dealer or Service Center. If the problem is not handled to your satisfaction, then write to the warrantor's Consumer Affairs Department at the addresses listed for the warrantor.

**PARTS AND SERVICE (INCLUDING COST OF AN IN-HOME SERVICE CALL, WHERE APPLICABLE) WHICH ARE NOT COVERED BY THIS LIMITED WARRANTY ARE YOUR RESPONSIBILITY.**

## **Customer Services Directory**

Service in Canada: As per Service Center listed in Canadian warranty information on page -56-.

Obtain Product Information and Operating Assistance; locate your nearest Dealer or Service Center; purchase Parts and Accessories; or make Customer Service and Literature requests by visiting our Web Site at:

**<http://www.panasonic.com/consumersupport>**

or, contact us via the web at:

**<http://www.panasonic.com/contactinfo>**

You may also contact us directly at:

1-800-211-PANA (7262),

Monday-Friday 9 am-9 pm; Saturday-Sunday 10 am-7 pm, EST

**For hearing or speech impaired TTY users, TTY : 1-877-833-8855**

### **Accessory Purchases**

Purchase Parts, Accessories and Instruction Books online for all Panasonic Products by visiting our Web Site at:

**<http://www.pstc.panasonic.com>**

or, send your request by E-mail to:

**[npcparts@us.panasonic.com](mailto:npcparts@us.panasonic.com)**

You may also contact us directly at:

1-800-332-5368 (Phone) 1-800-237-9080 (Fax Only) (Monday – Friday 9 am to 9 pm, EST.)

Panasonic Service and Technology Company

20421 84th Avenue South,

Kent, WA 98032

(We Accept Visa, MasterCard, Discover Card, American Express, and Personal Checks)

**For hearing or speech impaired TTY users, TTY : 1-866-605-1277**

### **Product Repairs**

#### **Centralized Factory Service Center**

**MAIL TO:**

Panasonic Camera and Digital Service Center

1590 Touhy Ave.

Elk Grove Village, IL 60007

Please carefully pack and ship, prepaid and insured, to the Elk Grove Village Centralized Factory Service Center.

Customer's in Puerto Rico, please ship or carry in to location below ("Service in Puerto Rico").

#### **Service in Puerto Rico**

**Panasonic Puerto Rico, Inc.**

**Ave. 65 de Infantería, Km. 9.5, San Gabriel Industrial Park,**

**Carolina, Puerto Rico 00985**

**Phone (787)750-4300, Fax (787)768-2910**

As of January 2007

---

**Warranty (For Canadian Customers)**

---

**Panasonic Canada Inc.**

5770 Ambler Drive, Mississauga, Ontario L4W 2T3

**PANASONIC PRODUCT – LIMITED WARRANTY**

Panasonic Canada Inc. warrants this product to be free from defects in material and workmanship and agrees to remedy any such defect for a period as stated below from the date of original purchase.

**Camcorder Product – One (1) year, parts and labour**

**LIMITATIONS AND EXCLUSIONS**

This warranty does not apply to products purchased outside Canada or to any product which has been improperly installed, subjected to usage for which the product was not designed, misused or abused, damaged during shipping, or which has been altered or repaired in any way that affects the reliability or detracts from the performance, nor does it cover any product which is used commercially. Dry cell batteries are also excluded from coverage under this warranty.

This warranty is extended to the original end user purchaser only. A purchase receipt or other proof of date of original purchase is required before warranty service is performed.

**THIS EXPRESS, LIMITED WARRANTY IS IN LIEU OF ALL OTHER WARRANTIES, EXPRESS OR IMPLIED, INCLUDING ANY IMPLIED WARRANTIES OF MERCHANTABILITY AND FITNESS FOR A PARTICULAR PURPOSE.**

**IN NO EVENT WILL PANASONIC CANADA INC. BE LIABLE FOR ANY SPECIAL, INDIRECT OR CONSEQUENTIAL DAMAGES.**

In certain instances, some jurisdictions do not allow the exclusion or limitation of incidental or consequential damages, or the exclusion of implied warranties, so the above limitations and exclusions may not be applicable.

**WARRANTY SERVICE**

**FOR PRODUCT OPERATION ASSISTANCE**, please contact:

Our Customer Care Centre: Telephone #: (905) 624-5505  
1-800 #: 1-800-561-5505  
Fax #: (905) 238-2360  
Email link: "Customer support" on [www.panasonic.ca](http://www.panasonic.ca)

**FOR PRODUCT REPAIRS**, please locate your nearest Authorized Servicentre at [www.panasonic.ca](http://www.panasonic.ca) :

Link: "Servicentres™ locator" under "Customer support"

**IF YOU SHIP THE PRODUCT TO A SERVICENTRE**

Carefully pack and send prepaid, adequately insured and preferably in the original carton.

Include details of the defect claimed, and proof of date of original purchase.



**Index**

■ Numerics		
4:3 Function .....	30	
■ A		
AC Adaptor .....	13, 48	
Aperture .....	34	
Auto slow shutter .....	31	
■ B		
Backlight Compensation .....	27	
Blank Search .....	25	
Built-in LED Video Light .....	22	
■ C		
Camcorder Accessory Order Form .....	52	
Charging the Battery .....	12	
Condensation .....	46	
Customer Services Directory .....	55	
■ D		
Date/Time Setting .....	15	
Digital Dubbing .....	38	
Digital Zoom .....	27	
Dubbing .....	37	
■ E		
Erasure Prevention Slider .....	18	
■ F		
Fade .....	29	
Frame-by-frame playback .....	36	
■ G		
Guideline function .....	30	
■ H		
Help mode .....	20	
■ L		
LCD Monitor .....	16, 48	
Limited Warranty (Canada) .....	56	
Limited Warranty (USA) .....	54	
Low Light Mode .....	32	
■ M		
MagicPix function .....	28	
Manual Focus .....	33	
Mode Dial .....	14	
■ O		
Optical image stabilizer function .....	30	
■ P		
Photoshot .....	26	
Portrait Mode .....	32	
■ Q		
Quick Start .....	17	
■ R		
Recording Check .....	25	
Recording Speed .....	23	
Remaining Tape Time .....	42	
Repeat Playback .....	35	
Request for Service Notice (USA Only) .....	53	
■ S		
Scene Mode .....	32	
Self-Recording .....	27	
Shutter Speed .....	34	
Soft Skin Mode .....	28	
Sound Volume .....	35	
SP/LP Mode .....	23	
Sports Mode .....	32	
Spotlight Mode .....	32	
Surf & Snow Mode .....	32	
■ V		
Video Head Clogging .....	46	
Viewfinder .....	16, 48	
■ W		
White Balance .....	33	
Wide Function .....	30	
Wind Noise Reduction Function .....	29	
■ Z		
Zoom .....	26	
Zoom Microphone .....	27	

## Spanish Quick Use Guide/ Guía española para el uso rápido

### ■ Carga de la batería

- 1 Conecte el cable eléctrico de ca al adaptador de ca y a la toma de la red de ca.
- 2 Meta la batería en el respectivo soporte alineando la marca, luego encájela.

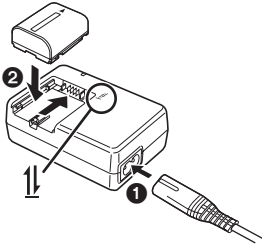

### ■ Montaje de la batería

Empuje la batería contra el porta batería y hágala deslizar hasta que dispere.

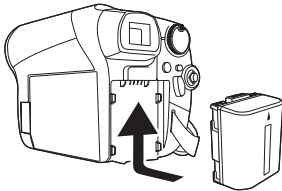

### ■ Insertar/quitar un cassette

- 1 Haga deslizar la palanca [OPEN/EJECT] y abra la tapa del cassette.

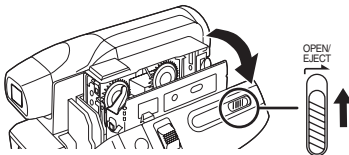

- 2 Una vez que el compartimiento del cassette esté abierto, inserte/quite el cassette.

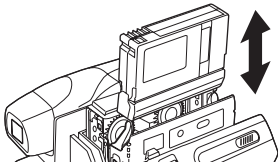

- 3 Apriete la marca [PUSH] 1 a fin de cerrar el compartimiento del cassette.

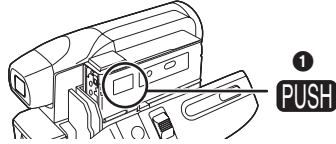

- 4 Sólo cierre la tapa del cassette después de que el respectivo compartimiento esté cabalmente alojado.

### ■ Cómo activar la alimentación

- 1 Mientras pulsa el botón de desbloqueo A, ajuste el selector del modo a para seleccionar el modo deseado B.

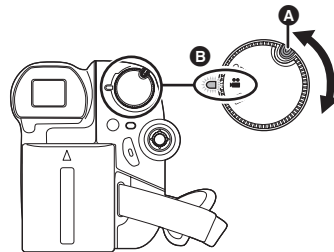

### ■ Cómo apagar la alimentación

- 1 Ajuste el disco del modo a OFF.

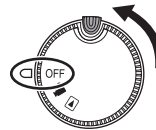

### ■ Grabación en una cinta

- Ajuste al modo de grabación de cinta.

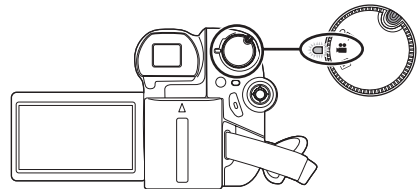

- 1 Oprima el botón de inicio/parada de la grabación para empezar a grabar.**

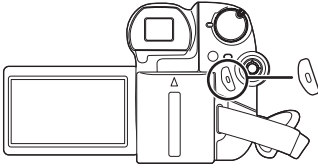

- 2 Oprima de nuevo el botón de inicio/parada de la grabación para detener brevemente la grabación.**



## ■ Reproducción de la cinta

- Ajuste al modo de reproducción de cinta.

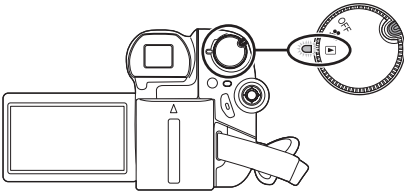

- 1 Actúe en la palanca de mando.**



- ▶/||: Reproducción/Pausa
- ◀◀: Rebobinado/Localización regresiva (Vuelve para reproducir con el icono ▶/||.)
- ▶▶: Avance rápido/Localización progresiva (Vuelve para reproducir con el icono ▶/||.)
- : Parada

**Panasonic Consumer Electronics Company,  
Division of Panasonic Corporation of North America**

One Panasonic Way, Secaucus, NJ 07094

**Panasonic Puerto Rico, Inc.**

Ave. 65 de Infantería, Km. 9.5, San Gabriel Industrial Park, Carolina, Puerto Rico 00985

**Panasonic Canada Inc.**

5770 Ambler Drive, Mississauga, Ontario, L4W 2T3



Printed in Indonesia

LSQT1284 A

F1107SQ0



© 2007 Matsushita Electric Industrial Co., Ltd.