

Panasonic

SD Multi AV Device

Operating Instructions

Model No. **SV-AV10E/B/EN**

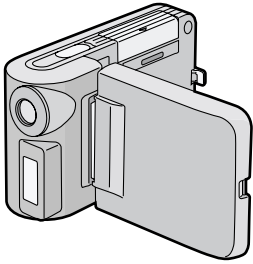

Before use, please read these instructions completely.



MultiMediaCard™

Contents

Information for Your Safety	3
Caution for AC mains lead (SV-AV10B only)	3
Introduction.....	4
Power supply frequency	4

Preparation

Standard Accessories	4
Optional Accessories.....	4
Controls and Components.....	5
Attaching the Neck Strap.....	5
Power Supply	6
Using AC Adaptor	6
Using the Battery	6
Inserting a Card	7
Removing the Card	7
Using the LCD Monitor	7
Turning the Power ON.....	8
Turning the Power OFF	8
Selecting Operation Modes	8
About the Operation Mode.....	8
Using the Menu Screen	9
List of Menus	9
REC MODE.....	9
PLAYBACK MODE	10
Setting the power supply frequency	12
To reduce the appearance of horizontal stripes consisting of light and dark patterns	12
Adjusting Brightness and Colour Level.....	13
To Adjust.....	13
Setting Date and Time.....	13

Basic Functions

Recording the Moving Picture (MPEG4)	14
To stop recording.....	14
Display in the moving picture (MPEG4) mode	14
Playing the Moving Picture (MPEG4)	15
To stop playback.....	15
To find the beginning of a moving picture file	15
To Change the Display Size	15
Recording Still Pictures	16
Display in the Still picture mode.....	16
Playing back Still Pictures	17
To stop playback.....	17
To play the next (previous) file.....	17
Recording Voice (Voice Recording Function)....	18
To stop recording.....	18
Display in the Voice Mode	18
Hearing the Voice Recorded (Playback Sound) 19	
To stop playback.....	19
Fast forward (fast backward) playback	19
To find the beginning of a voice file:	19
Listening to Music (Music Play)	20
To stop playback.....	20

To find the beginning of a music file:	20
Using the Earphone	21
Adjusting the Volume.....	21

Advanced Functions

Backlight Compensation Function	22
Adjusting White Balance.....	22
Erasing the Files Recorded on a Card.....	23
To erase All Files	23
Protecting the file (Lock Setting).....	24
To release the lock setting:.....	24
To lock all files:	24
Writing Printing Data on a Card (DPOF Setting)25	
To release all the DPOF settings:.....	25
Playing back still pictures one by one (Slide Show) 26	
To cancel the Slide Show:	26
Formatting the Card.....	26

For using SD-MovieStage

Operating environment	27
Installing SD-MovieStage	28
Cautions for Windows XP/2000 Professional	28
Starting SD-MovieStage	28

Others

Notes & Precautions	29
Charge the built-in battery for maintaining the date information.....	29
After Use.....	29
Using a Card in a Personal Computer	30
Indications.....	31
Cautions for Use	32
About the Lens.....	33
About the AC Adaptor	33
About the LCD Monitor	33
Optimal Use of the Battery.....	33
Notes on the SD Memory Card Write-Protect Switch 34	
Cautions for Storage.....	34
Fogging of lens	34
State of Power Lamp while charging	34
Before Requesting Service	35
Specifications.....	36

Dear Customer,

We would like to take this opportunity to thank you for purchasing this Panasonic SD Multi AV Device. Please read these Operating Instructions carefully and keep them handy for future reference.

Information for Your Safety**WARNING**

TO REDUCE THE RISK OF FIRE OR SHOCK HAZARD AND ANNOYING INTERFERENCE, USE ONLY THE RECOMMENDED ACCESSORIES AND DO NOT EXPOSE THIS EQUIPMENT TO RAIN OR MOISTURE. DO NOT REMOVE THE COVER (OR BACK); THERE ARE NOT USER SERVICEABLE PARTS INSIDE. REFER SERVICING TO QUALIFIED SERVICE PERSONNEL.

Carefully observe copyright laws.

Recording of pre-recorded tapes or discs or other published or broadcast material for purposes other than your own private use may infringe copyright laws. Even for the purpose of private use, recording of certain material may be restricted.

- Please note that the actual controls and components, menu items, etc. of your SD Multi AV Device may look somewhat different from those shown in the illustrations in these Operating Instructions.
-  : SD Logo is a trademark.
- Other names, company names, and product names printed in these instructions are trademarks or registered trademarks of the companies concerned.
- The SD Multi AV Device uses copyright-protected technologies and is protected by the patented technologies and intellectual properties of Japan and the U.S. To use these copyright-protected technologies, authorization of the Macrovision Company is required. It is prohibited to disassemble or modify the SD Multi AV Device.
- (→ 00) indicates the page to be referred to.
- Note that the SD Multi AV Device may not play back the data recorded or created on another product and another product may not play back the data recorded on the SD Multi AV Device.
- The nameplate of the SD Multi AV Device is fixed on the bottom of the battery holder.



Caution for AC mains lead (SV-AV10B only)

Message to User who has Power Cable  as an accessory. (→ 4)

For your safety, please read the following text carefully.

This appliance is supplied with a moulded three-pin mains plug for your safety and convenience. A 5-ampere fuse is fitted in this plug.

Should the fuse need to be replaced, please ensure that the replacement fuse has a rating of 5-amperes and it is approved by ASTA or BSI to BS1362.

Check for the ASTA mark  or the BSI mark  on the body of the fuse.

If the plug contains a removable fuse cover you must ensure that it is refitted when the fuse is replaced. If you lose the fuse cover, the plug must not be used until a replacement cover is obtained. A replacement fuse cover can be purchased from your local Panasonic Dealer.

IF THE FITTED MOULDED PLUG IS UNSUITABLE FOR THE SOCKET OUTLET IN YOUR HOME THEN THE FUSE SHOULD BE REMOVED AND THE PLUG CUT OFF AND DISPOSED OF SAFELY. THERE IS A DANGER OF SEVERE ELECTRICAL SHOCK IF THE CUT OFF PLUG IS INSERTED INTO ANY 13-AMPERE SOCKET.

If a new plug is to be fitted, please observe the wiring code as shown below.

If in any doubt, please consult a qualified electrician.

IMPORTANT

The wires in this mains lead are coloured in accordance with the following code:

Blue: Neutral
Brown: Live

As the colours of the wires in the mains lead of this appliance may not correspond with the coloured markings identifying the terminals in your plug, proceed as follows:

The wire which is coloured BLUE must be connected to the terminal in the plug which is marked with the letter N or coloured BLACK.

The wire which is coloured BROWN must be connected to the terminal in the plug which is marked with the letter L or coloured RED.

Under no circumstances should either of these wires be connected to the earth terminal of the three-pin plug, marked with the letter E or the Earth Symbol .

Before Use

Remove the Connector Cover as follows.

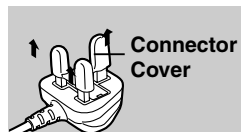
**How to replace the Fuse**

- 1) Remove the Fuse Cover with a screwdriver.

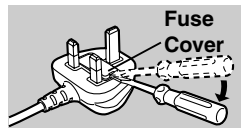

- 2) Replace the fuse and attach the Fuse Cover.

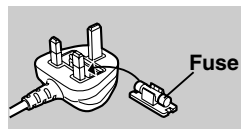

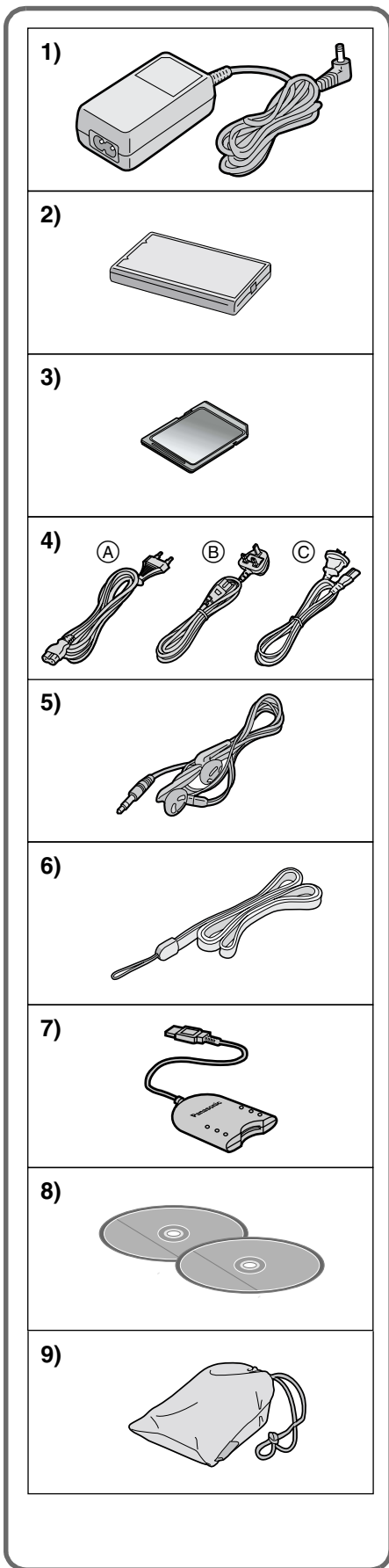

Introduction

This SD Multi AV Device can record both still picture data and MPEG4 moving picture. Additionally, it can play back a high quality music file of the MPEG2-AAC and MP3 format (Record files with the supplied real jukebox[®] and USB Reader/Writer). And using the viewer software SD-MovieStage (supplied accessory), this SD Multi AV Device can display the pictures recorded with it as thumbnails and edit the MPEG4 moving picture data.

Power supply frequency

Under fluorescent lighting, horizontal stripes consisting of light and dark patterns may appear on the screen as illustrated below. To reduce the affect of the horizontal stripes, switch the power supply frequency to 50 Hz or 60 Hz.(→ 12)



Preparation

Standard Accessories

Illustrated on the left are accessories packaged with the SD Multi AV Device (Panasonic SV-AV10E).

- 1) **AC Adaptor (VSK0621) (→ 6)**
 - Supplies power to the SD Multi AV Device.
- 2) **Battery Pack (CGA-S301E) (→ 6)**
 - Supplies power to the SD Multi AV Device.
- 3) **SD Memory Card (8 MB) (RPSD008BVE0) (→ 7)**
- 4) **Power Cable (→ 6)**
 - Ⓐ:SV-AV10E/EN (VJA0664)
 - Ⓑ:SV-AV10B only (VJA0940)
 - Ⓒ:SV-AV10EN only (VJA0754)
- 5) **Earphone (LOBAB0000172) (→ 19, 20, 21)**
- 6) **Neck Strap (VFC3838) (→ 5)**
- 7) **USB Reader/Writer (BN-SDCBAE)**
 - For the operation of the USB Reader/Writer, refer to the additional instruction supplied in the same package.
- 8) **CD-ROM (→ 27)**
 - SD-MovieStage (For Windows[®] 98SE/Me/2000 Professional/XP Home Edition/XP Professional) (VFF0143)**
 - Panasonic Media Manager (real jukebox[®],realplayer etc.) (VFF0148)**
 - For the installation and the operation of the **Panasonic Media Manager**, refer to the additional instructions supplied in the same package.
 - For using the SD-MovieStage software, refer to the PDF manual. This manual describes installation only.
- 9) **Carrying Case (RFC0069-H)**
 - Put the SD Multi AV Device in the Carrying Case supplied after use or when carrying it.

Optional Accessories

- 10) **Battery Pack (CGA-S301E) (→ 6)**
 - Same product as that mentioned in 2).

Controls and Components

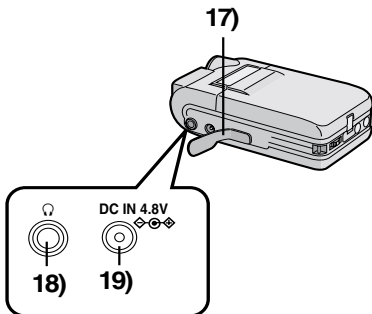
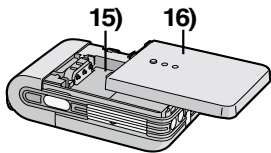
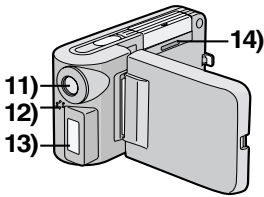
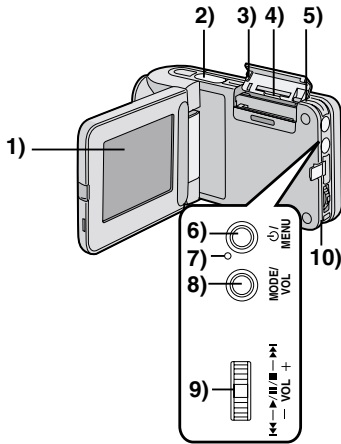

- 1) LCD Monitor (→ 7)
- 2) Recording Start/Stop Button (→ 14, 16, 18)
- 3) Card Slot Cover (→ 7)
- 4) Card Slot (→ 7)
- 5) Card Access Lamp (→ 7)
- 6) Power ON/OFF Button [] (→ 8)
- 7) Menu Button [MENU] (→ 9)
- 8) Power Lamp (→ 8)
- 9) Mode Selector Button [MODE] (→ 8)
- 10) Volume Adjustment Button [VOL] (→ 21)
- 11) Jog Lever [] (→ 8, 22)
- 12) Strap Holder (→ 5)
- 13) Lens
- 14) Microphone (built-in, monaural) (→ 18)
- 15) Flash (→ 16)
- 16) Card View Window
- 17) Battery Compartment (→ 6)
- 18) Battery Compartment Cover (→ 6)
- 19) Terminal Cover
- 20) Earphone Socket [] (→ 15, 19, 20, 21)
- 21) DC Input Socket [DC IN 4.8V] (→ 6)

Attaching the Neck Strap

- 1 Pass the shorter loop of the Neck Strap through the Strap Holder .
- 2 Pass the big loop of the Strap through the small loop.
 - When using the Strap to carry the SD Multi AV Device, loop the Strap around your neck and be careful not to accidentally hit the SD Multi AV Device against hard objects.

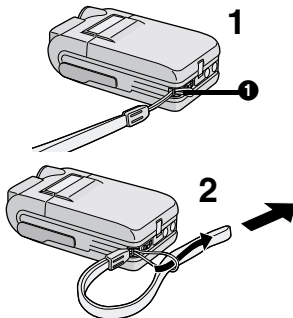

Power Supply

■ Using AC Adaptor

- 1 **Connect the AC Mains Lead to the AC Adaptor and the AC mains socket.**
 - The AC Mains Lead does not fit entirely into the AC Adaptor socket. A gap will remain as shown ❶.
- 2 **Connect the DC Input Lead to the [DC IN 4.8V] socket on the SD Multi AV Device.**

The SOCKET OUTLET SHALL BE INSTALLED NEAR THE EQUIPMENT AND SHALL BE EASILY ACCESSIBLE.

Using the Battery

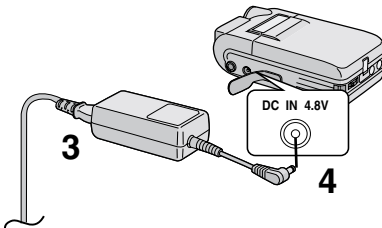
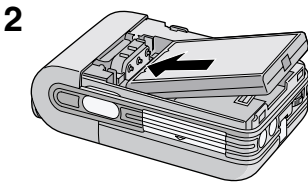
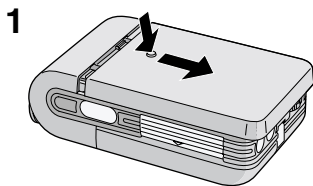

Removing the Battery

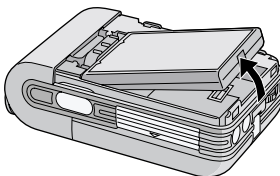

■ Using the Battery

- 1 **While holding the [] part, slide it to remove the Battery Compartment Cover.**
- 2 **Press the terminals of the battery onto the terminals of the Battery Compartment and set the battery.**
 - Fit the battery with its label facing upward.
 - After the battery is set, close the cover.
- 3 **Connect the AC Mains Lead to the AC Adaptor and the AC Mains socket.**
- 4 **Connect the DC Input Lead to the [DC IN 4.8V] socket on the SD Multi AV Device.**
 - Power Lamp flashes, and Charging starts.
- 5 **Wait until Power Lamp goes off.**
 - When recharging is completed, Power Lamp goes off.
 - Disconnect the DC cord and hold down the [] button for two seconds or more, and the SD Multi AV Device is turned ON.

CAUTION

Danger of explosion if battery is incorrectly replaced.

Replace only with the same or equivalent type recommended by the manufacturer.
Dispose of used batteries according to the manufacturer's instructions.

- When the Battery Level Indicator indicates [], the battery will run out in a few minutes. Recharge the battery.
- It takes about 120 minutes, maximum for full-charging. (The charging times are for normal ambient temperature (20° C/60%). If the Battery is charged at a higher or lower temperature, the charging time may be longer)
- When recharging, turn the power of the SD Multi AV Device OFF.
- If the Power Lamp flashes quickly (or slowly) when recharging, recharging is not normal. (→ 34)
- When the battery is running out while the SD Multi AV Device is being used, the Power Lamp starts to flash. Recharge the battery or use the SD Multi AV Device with the DC cord connected.
- If you disconnect the DC Input Lead or the AC Mains Lead while charging the Battery, Power Lamp flashes several times and goes off. For continuing Battery charge, wait for about 1 minutes, and then connect the AC Mains Lead and the DC Cord.

Inserting a Card

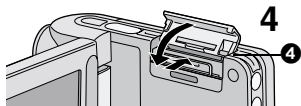
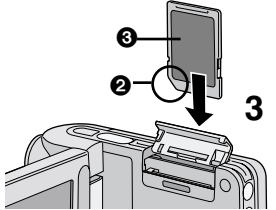
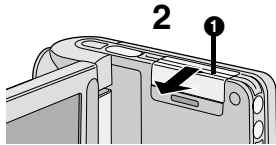

Removing the Card

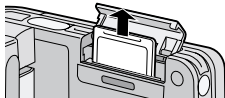

Inserting a Card

- 1 Slide the Card Slot Cover ①, and flip it to open.
 - Turn off the SD Multi AV Device, when inserting a Card.
- 2 Hold the Memory Card placing the cut off corner ② at the left and showing the label ③ frontward, and then insert it fully until it clicks.
- 3 After the Memory Card is set, close the Card Slot Cover ①.

Removing the Card

Open the Card Slot Cover and push the top of the Card. The Card will pop up a little and allow you to pick it up with your fingers to remove.

- While the Card Access Lamp ④ is on, the following operations should not be attempted: (Such action will damage the Card, cause loss of recorded data and cause the SD Multi AV Device to malfunction.)
 - Open the Card Slot Cover.
 - Remove or insert the Card.
 - Operate your SD Multi AV Device.
 - Remove the battery or unplug the power cable.
 - Apply vibration or shock.
- Only an SD Memory card or MultiMediaCard can be used for this SD Multi AV Device.
- Do not touch the terminals on the back of the Card with your fingers.
- If the Card Slot Cover is not closed completely, remove the Memory Card and re-insert it.
- Electrical noise, static electricity or failure of the SD Multi AV Device or the card may damage the card or erase the data stored on the card. It is recommended to save important data onto a personal computer.

Using the LCD Monitor

Record and play the video image while viewing the LCD Monitor.

- 1 Put your finger on the protrusion ① to open the LCD Monitor.
- 2 Adjust the LCD Monitor angle according to the desired recording/playing angle.
 - The LCD Monitor can rotate a maximum of 180° ② from the vertical position to the upward direction and a maximum of 90° ③ to the downward direction. Forcefully rotating the LCD Monitor beyond these ranges will damage the SD Multi AV Device.
- The picture will be displayed upside down at some playing angles. If [UPSIDE-DOWN] is selected for [LCD MONITOR] under the [OTHER FUNCTIONS] menu the picture will be displayed upside down.

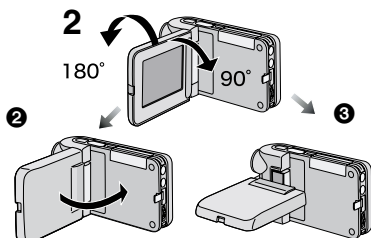
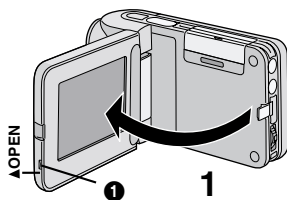

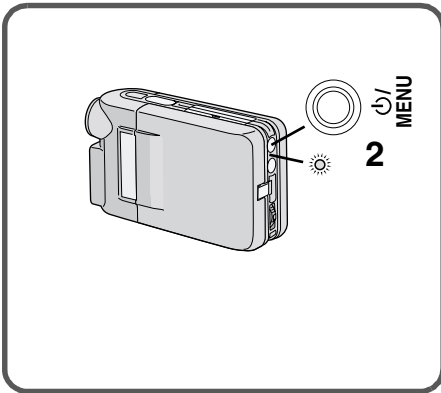

Turning the Power ON

- 1 Install the battery or plug in the AC adaptor. (→ 6)
- 2 Hold down the [] button for two seconds or more.
 - The SD Multi AV Device is turned on.
 - The message [PLEASE WAIT] is displayed for a while and then the mode selection screen will be displayed.
 -
 - If the device is not used for 10 minutes or longer, the power is automatically turned off. Press the power button again to turn it back on.

Turning the Power OFF

While the Power is on, hold down the [] button for two seconds or more.

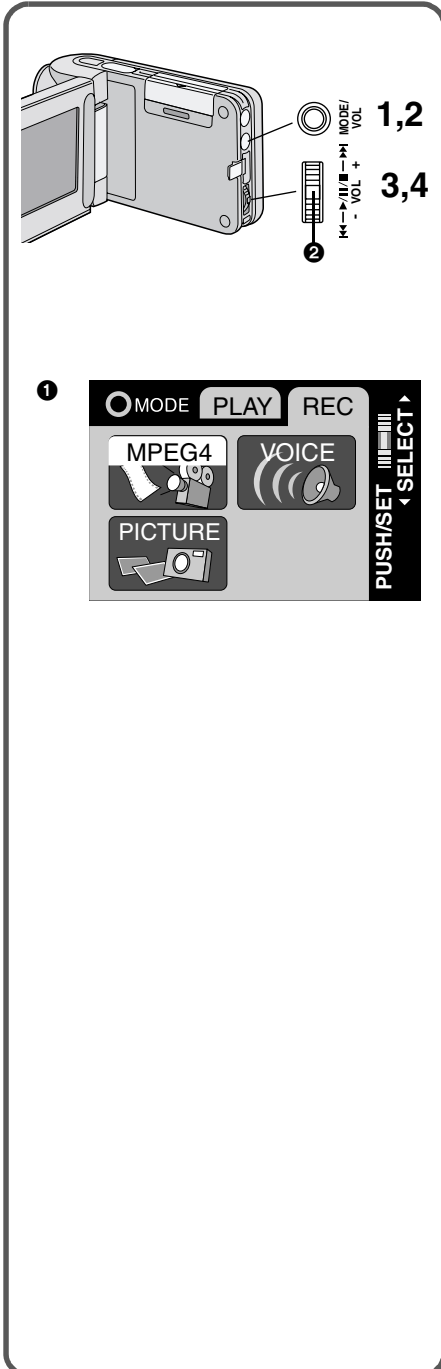

Selecting Operation Modes

Select a desired mode on the mode selection screen.

- 1 Press the [MODE] Button.
 - The mode selection screen ① appears.
 - The mode selection screen also appears when the power is turned on.
- 2 Press the [MODE] Button to select [REC] or [PLAY].
 - Alternates between [REC] and [PLAY] by a push.
- 3 Move the Jog Lever up or down to select a desired mode.
- 4 Press down the centre of the Jog Lever ②.
 - The mode selection screen disappears, and the selected mode is now set.

About the Operation Mode

Seven operation modes are provided as follows.

- Moving picture (MPEG4 format) record mode [REC>>MPEG4]
- Moving picture (MPEG4 format) play mode [PLAY>>MPEG4]
- Still picture (JPEG format still picture) record mode [REC>>PICTURE]
- Still picture (JPEG format still picture) play mode [PLAY>>PICTURE]
- Sound (VOICE format) record mode [REC>>VOICE]
- Sound (VOICE format) play mode [PLAY>>VOICE]
- Music (MPEG2-AAC music/ MP3 format) play mode [PLAY>>MUSIC]

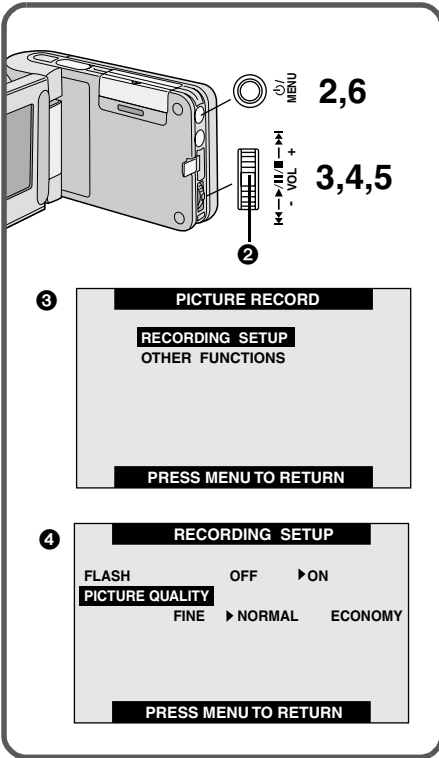

Using the Menu Screen

Allows the functions useable in the selected mode to be set from the menu.

- 1 **Select a desire mode. (→ 8)**
- 2 **Press the [MENU] Button.**
 - A list of menus useable in the selected mode is displayed ③.
- 3 **Move the Jog Lever up or down to select a desired menu.**
- 4 **Press down the centre of the Jog Lever ②.**
 - Menu screen appears.④
- 5 **Move the Jog Lever up or down to select a desired item and press down the centre of the Jog Lever ②.**
 - With each press of ②, the cursor [▶] moves to the next mode.
- 6 **Press the [MENU] Button.**
 - Menu screen disappears, and the selected item is now being set.

- To abort the setting, press the [MENU] Button.
- While a Menu is displayed, you cannot record or play back.
- Menu operation flow is indicated in these Operating Instructions by >>>.
- Set the power supply frequency before use.
- Press the [MENU] button when playing back the moving picture, still picture or sound to edit the file being played back.

List of Menus

The figures of the Menus are for explanation purposes only, and they are different from the actual Menus.

REC MODE

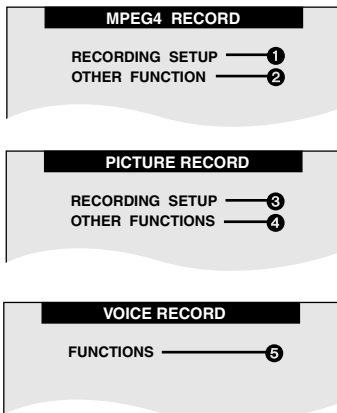

REC MODE

[MPEG4 RECORD] Menu

Recording Setup [RECORDING SETUP]
Other Functions [OTHER FUNCTIONS]

[PICTURE RECORD] Menu

Recording Setup [RECORDING SETUP]
Other Functions [OTHER FUNCTIONS]

[VOICE RECORD] Menu

Functions [OTHER FUNCTIONS]

Sub-Menu for REC MODE

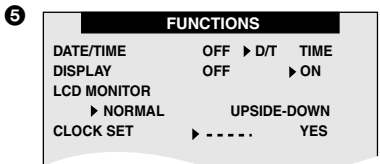
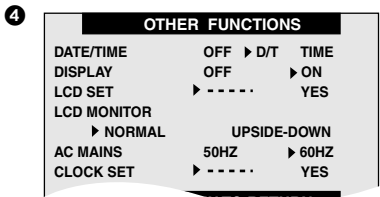
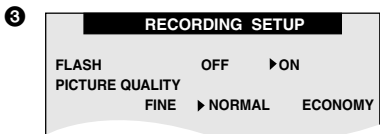
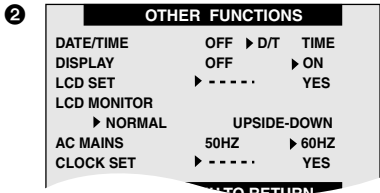

PLAYBACK MODE

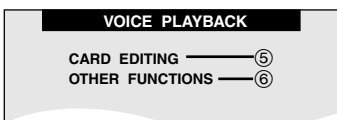
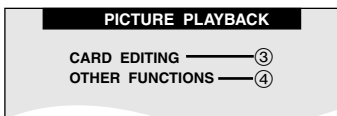
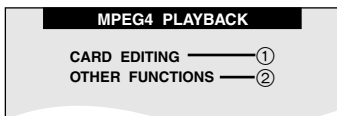

List of Menus (Cont.)

Sub-Menu for REC MODE

- 1 MPEG4 Mode [MPEG4 MODE] (→ 14)
- 2 Date/Time [DATE/TIME] (→ 13)
Display [DISPLAY]
LCD Set [LCD SET] (→ 13)
LCD Monitor [LCD MONITOR] (→ 9)
AC Mains [AC MAINS] (→ 12)
Clock set [CLOCK SET] (→ 13)
- 3 Flash [FLASH] (→ 16)
Picture Quality [PICTURE QUALITY] (→ 16)
- 4 Date/Time [DATE/TIME] (→ 13)
Display [DISPLAY]

- LCD Set [LCD SET] (→ 13)
LCD Monitor [LCD MONITOR] (→ 9)
AC Mains [AC MAINS] (→ 12)
Clock set [CLOCK SET] (→ 13)
- 5 Date/Time [DATE/TIME] (→ 13)
Display [DISPLAY]
LCD Monitor [LCD MONITOR] (→ 9)
Clock set [CLOCK SET] (→ 13)

PLAYBACK MODE

[MPEG4 PLAYBACK] Menu

Card Editing [CARD EDITING]
Other Functions [OTHER FUNCTIONS]

[PICTURE PLAYBACK] Menu

Card Editing [CARD EDITING]
Other Functions [OTHER FUNCTIONS]

[VOICE PLAYBACK] Menu

Card Editing [CARD EDITING]
Other Functions [OTHER FUNCTIONS]

[MUSIC PLAYBACK] Menu

Repeat Setup [REPEAT SETUP]
Other Functions [OTHER FUNCTIONS]

Sub-Menu for PLAYBACK

① **CARD EDITING**

ERASE ALL FILES		
FILE PROTECTION	▶-----	YES
CARD FORMAT	▶-----	YES

② **OTHER FUNCTIONS**

DATE/TIME	OFF ▶ D/T	TIME
DISPLAY	OFF	▶ ON
LCD SET	▶-----	YES
DISPLAY SIZE	FULL	▶NORMAL
LCD MONITOR	▶ NORMAL UPSIDE-DOWN	
CLOCK SET	▶-----	YES

③ **CARD EDITING**

ERASE ALL FILES		
FILE PROTECTION	▶-----	▶YES
DPOF SETTING	▶-----	YES
SLIDE SHOW	▶-----	YES
CARD FORMAT	▶-----	YES

④ **FUNCTIONS**

DATE/TIME	OFF ▶ D/T	TIME
DISPLAY	OFF	▶ ON
LCD MONITOR	▶ NORMAL UPSIDE-DOWN	
CLOCK SET	▶-----	YES

⑤ **CARD EDITING**

ERASE ALL FILES		
FILE PROTECTION	▶-----	YES
CARD FORMAT	▶-----	YES

⑥ **OTHER FUNCTIONS**

DATE/TIME	OFF ▶ D/T	TIME
DISPLAY	OFF	▶ ON
LCD MONITOR	▶ NORMAL UPSIDE-DOWN	
CLOCK SET	▶-----	YES

⑦ **REPEAT SETUP**

REPEAT SETUP		
OFF	▶ 1MUSIC	ALL

⑧ **OTHER FUNCTIONS**

DATE/TIME	OFF ▶ D/T	TIME
DISPLAY	OFF	▶ ON
LCD MONITOR	▶ NORMAL UPSIDE-DOWN	
CLOCK SET	▶-----	YES

List of Menus (Cont.)

Sub-Menu for PLAYBACK MODE

- ① Erase All Files [ERASE ALL FILES] (→ 23)
File Protection [FILE PROTECTIONS] (→ 24)
Card Format [CARD FORMAT] (→ 26)
- ② Date/Time [DATE/TIME] (→ 13)
Display [DISPLAY]
LCD Set [LCD SET] (→ 13)
Display Size [DISPLAY SIZE] (→ 15)
LCD Monitor [LCD MONITOR] (→ 9)
Clock set [CLOCK SET] (→ 13)
- ③ Erase All Files [ERASE ALL FILES] (→ 23)
File Protection [FILE PROTECTIONS] (→ 24)
DPOF Setting [DPOF SETTING] (→ 25)
Slide Show [SLIDE SHOW] (→ 26)
Card Format [CARD FORMAT] (→ 26)
- ④ Date/Time [DATE/TIME] (→ 13)
Display [DISPLAY] (→ 10)
Display Size [DISPLAY SIZE] (→ 15)
LCD Monitor [LCD MONITOR] (→ 9)
Clock set [CLOCK SET] (→ 13)
- ⑤ Erase All Files [ERASE ALL FILES] (→ 23)
File Protection [FILE PROTECTIONS] (→ 24)
Card Format [CARD FORMAT] (→ 26)
- ⑥ Date/Time [DATE/TIME] (→ 13)
Display [DISPLAY] (→ 10)
LCD Monitor [LCD MONITOR] (→ 9)
Clock set [CLOCK SET] (→ 13)
- ⑦ Repeat Setup [REPEAT SETUP] (→ 20)
- ⑧ Date/Time [DATE/TIME] (→ 13)
Display [DISPLAY] (→ 10)
LCD Monitor [LCD MONITOR] (→ 9)
Clock set [CLOCK SET] (→ 13)

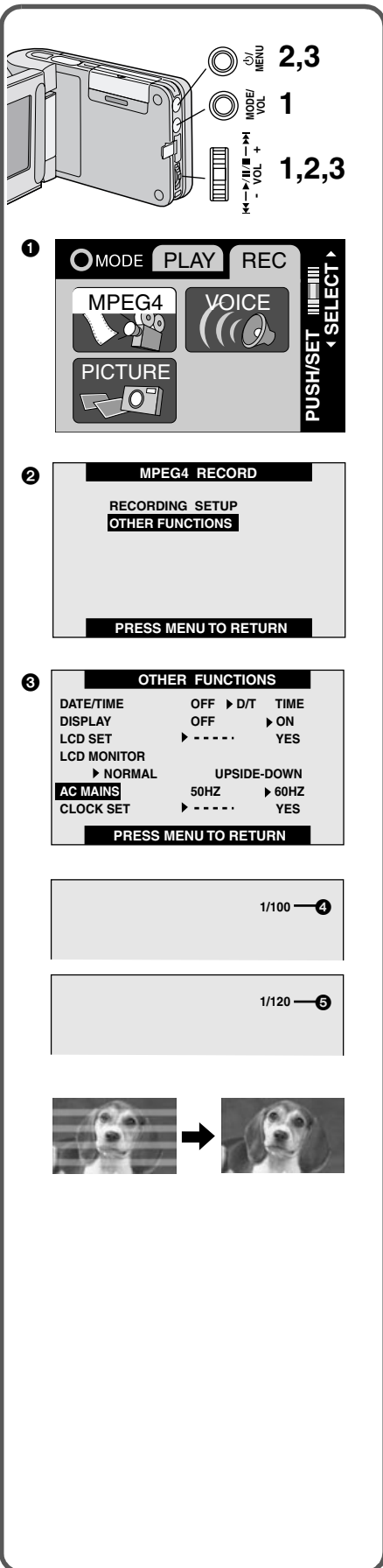

Setting the power supply frequency

Set the power supply frequency before using the SD Multi AV Device. The power supply frequency is different depending on the country or region.

Adjustment of the frequency will help reduce the appearance of horizontal stripes consisting of light and dark patterns under fluorescent lighting.

- 1 Set the Operation Mode to [REC>> MPEG4] or [REC>> PICTURE] ①. (→ 8)
- 2 Select the [OTHER FUNCTIONS] ②.
- 3 Set the [AC MAINS] ③ to [50 HZ] or [60 HZ].

- This setting may not completely suppress the horizontal stripes
- Irrespective of the setting, the horizontal stripes may still be presented in the following cases.
 - When using the SD Multi AV Device to record pictures under a lighting instrument such as a high-frequency fluorescent lamp:
 - When using the SD Multi AV Device to record a lighting instrument such as a fluorescent lamp:

To reduce the appearance of horizontal stripes consisting of light and dark patterns

If adjustment of the frequency does not have much effect on reducing horizontal stripes, operate the SD Multi AV Device as follow.

- 1 Set the Operation Mode to [REC>> MPEG4] or [REC>> PICTURE] ①.(→ 8)
- 2 Move the Jog Lever down for about 1 second.
 - The [1/100] Indication ④ appears when the power supply frequency is set to [50 Hz].
 - The [1/120] Indication ⑤ appears when the power supply frequency is set to [60 Hz].

To Release this mode

Move the Jog Lever down for about 1 second.

- Turning the power OFF will release this mode.

- It is not possible to use Backlight Compensation Mode when this mode is set to ON.
- If this mode is used for outdoor recording, the entire image on the screen (or recording images) may be tinged with white.
- This mode cannot be set or released while recording.
- The SD Multi AV Device adjusts the brightness by varying the shutter speed. However, the shutter speed is fixed in this mode and the brightness cannot be adjusted.

Adjusting Brightness and Colour Level

1,5
MENU

1,2,3,4
+ / - / M / VOL

1

MPEG4 RECORD	
RECORDING SETUP	
OTHER FUNCTIONS	
PRESS MENU TO RETURN	

2

OTHER FUNCTIONS			
DATE/TIME	OFF	D/T	TIME
DISPLAY	OFF		ON
LCD SET		----	YES
LCD MONITOR			
	▶ NORMAL		UPSIDE-DOWN
AC MAINS	▶ 50HZ		60HZ
CLOCK SET	▶ -----		YES
PRESS MENU TO RETURN			

LCD SET

BRIGHTNESS		4
[-]		[+]
COLOUR LEVEL		5
[-]		[+]
PRESS MENU TO RETURN		

LCD Brightness [BRIGHTNESS] 4

It adjusts the brightness of the image on the LCD screen.

LCD Colour Level [COLOUR LEVEL] 5

It adjusts the colour saturation of the image on the LCD screen.

To Adjust

- 1 Select the [OTHER FUNCTIONS] 1.
- 2 Set the [LCD SET] to [Yes] 2.
- 3 Press down the centre of the Jog Lever 3 to select the item to be adjusted.
- 4 Move the Jog Lever up or down to raise or lower the number of vertical bars in the Bar Indication.
 - A larger number of vertical bars indicates stronger brightness or colour saturation.
- 5 Press the [MENU] Button twice.
 - The [LCD SET] screen disappears.

- These adjustments do not affect the recorded images.
- Do adjustment in the moving picture record mode or still picture record mode.

Setting Date and Time.

Set the date and time from the [MENU] screen.

1,4
MENU

1,2,3
+ / - / M / VOL

6

OTHER FUNCTION			
DATE/TIME	OFF	D/T	TIME
DISPLAY	OFF		ON
LCD SET	▶ -----		YES
LCD MONITOR			
	▶ NORMAL		UPSIDE-DOWN
AC MAINS	▶ 50HZ		60HZ
CLOCK SET	----		▶ YES
PRESS MENU TO RETURN			

7

CLOCK SET	
YEAR	2002
MONTH	MAR.
DAY	20
HOUR	AM10
MIN	35
PRESS MENU TO RETURN	

- 1 Select the [OTHER FUNCTIONS] to set [Yes] on the [CLOCK SET]. 6
- 2 Move the Jog Lever up or down to set [YEAR] to a desired value, and press down the centre of the Jog Lever to move to [MONTH].
- 3 In the same way, set [MONTH], [DAY], [HOUR], [MINUTE] to a desired value. 7
- 4 Press the [MENU] Button to exit the date setting.
 - The second display starts from 0 (zero).
 - Press the [MENU] Button again to terminate the menu screen.

- The built-in battery sustains the operation of the clock.
- The time format is a 24 hour clock.
- The clock might cause a deviation from the correct date and/or time, so that check the current date and/or time before filming a movie or taking a photo.
- If the [] indicator is displayed, set the date and time after the battery has charged. (→ 29)

Basic Functions

Recording the Moving Picture (MPEG4)

You can record moving pictures on the Card.

- 1 Set the Operation Mode to [REC>> MPEG4] ①
- 2 Select the [RECORDING SETUP]②.
- 3 Set the [MPEG4 MODE] ③ to desired picture quality.
 - Select one of the options of [FINE], [NORMAL], [ECONOMY1], or [ECONOMY2].
 - Press the [MENU] Button twice to exit menu.
- 4 Press the Recording Start/Stop Button.
 - Recording starts.

To stop recording

While recording the moving picture, press the Recording Start/Stop Button ④.

- If the moving picture is recorded again after stopping recording, it will be saved as another file.

Display in the moving picture (MPEG4) mode

-  : Moving picture mode.
- R:0h00m: Remaining Time Indication
- F/N/E1/E2: Shows the picture quality. [F]: Fine, [N]: Normal , [E1]: Economy1 and [E2] :Economy2.
(The picture quality in E2 is lower than E1).

- The MPEG4 moving pictures can be recorded in any mode, but moving pictures recorded in the [FINE], [NORMAL] or [ECONOMY 1] mode may not be played on other Panasonic digital video cameras. The message [Press RESET button.] may be displayed in such case. This is not a fault of the camera.
- The MPEG4 moving pictures recorded in the [ECONOMY 2] mode may not be played, if it was a short recording (4 seconds or shorter).
- The picture quality level deteriorates, if the [ECONOMY 1/2] in the [RECORDING SET UP] MENU is selected.
- The recorded data can be also played back on Windows® Media Player.(→ 30)
- Record the subject approx.50 cm away from it.
- The capacities of the recording time for MPEG4 files are as follows:

	Fine	Normal	Economy1	Economy2
8MB	2 min	3 min	6 min	8 min
16MB	4 min	7 min	14 min	19 min
32MB	10 min	15 min	30 min	40 min
64MB	20 min	32 min	60 min	80 min

The times listed in the above table are approximate.

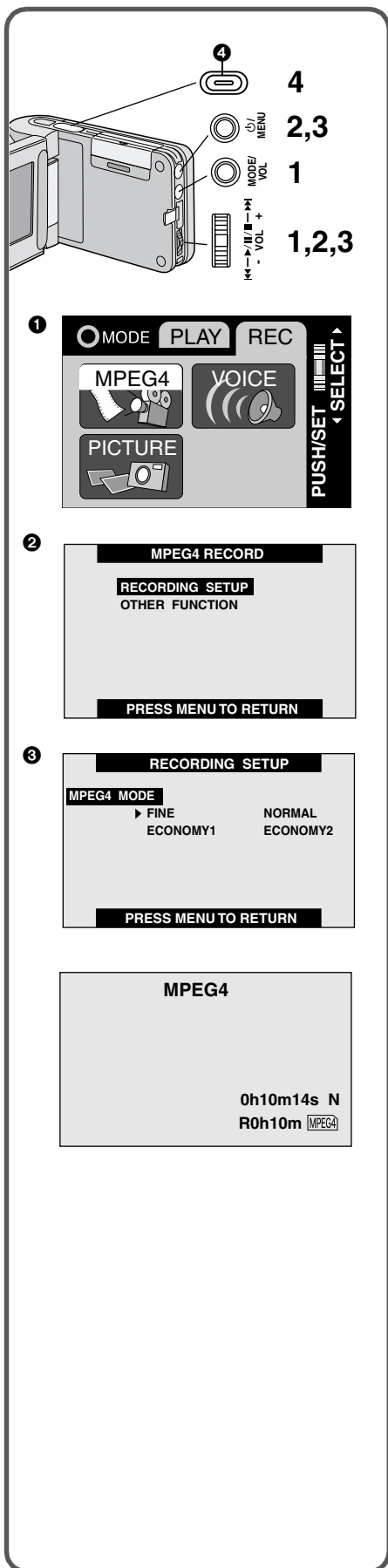

Playing the Moving Picture (MPEG4)

Plays back moving pictures recorded on the card.

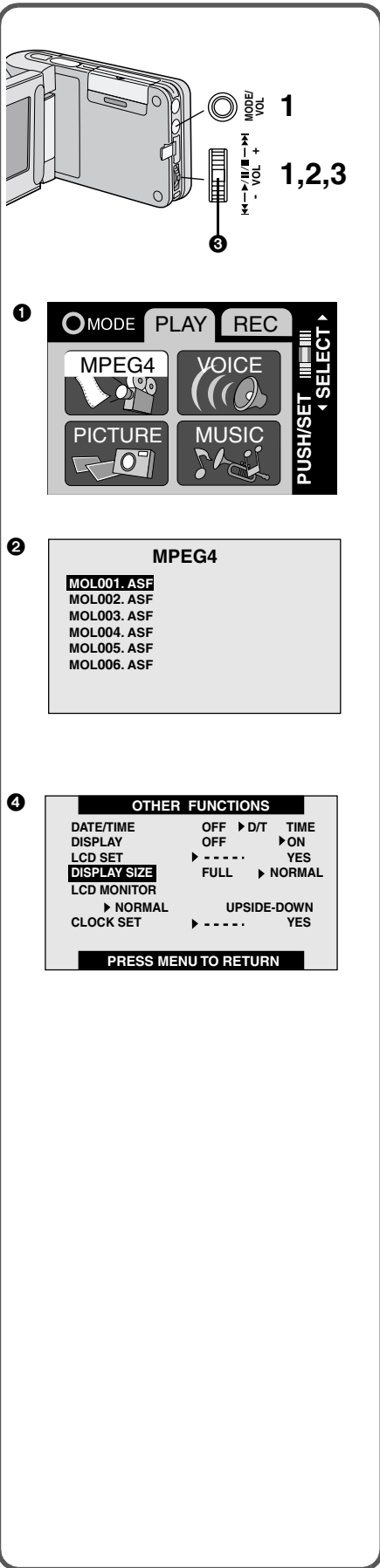

1 Set the Operation Mode to [PLAY>>MPEG4] ①

- Moving picture files recorded on the card are displayed in the form of a list (six files per page) ②.

2 Move the Jog Lever up or down to select a desired file.

3 Press down the centre of the Jog Lever ③.

- A moving picture file is played back.
- After playing back the files with the number selected and after, the file list reverts.
- Wear the Earphone (supplied) to listen to the sound.

To stop playback

While playing back, hold down the centre of the Jog Lever ③ for about two seconds.

- Playback is stopped and moving picture files are displayed in the form of a list.
- Press once, and the play back will pause.

To find the beginning of a moving picture file

While playing back, move the Jog Lever up or down.

To Change the Display Size

Select [FULL] or [NORMAL] from the [DISPLAY SIZE] option under the [OTHER FUNCTIONS] Menu ④.

- If the [FULL] is selected, the quality of picture will degrade slightly.
- If the picture recorded on another machine is played back in the [FULL] mode, a part of the picture will be clipped.

- To hear the sound, the earphone must be plugged into the jack of the SD Multi Audio Device.
- Files are numbered hexadecimally.
- The file format supported by this SD Multi AV Device is ASF. (Some ASF formatted files may not be played back.)
- When a moving picture is played back, a mosaic may appear or some frames may be missing; but this is normal.
- MPEG4 files recorded by another device may not be played back.
- Fast forward or slow playback is not available.
- When playing back a picture recorded by other equipment, picture size may differ.
- Refer to Page 21 for volume adjustment.
- Refer to Page 30 for viewing pictures on a personal computer.

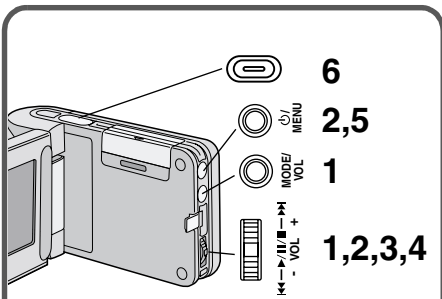

Recording Still Pictures

Records still pictures.

- 1 Set the Operation Mode to [REC>>PICTURE] ①
- 2 Select [RECORDING SETUP] ②.
- 3 Set the [PICTURE QUALITY] ③ to desired picture quality.
 - Select one of [FINE], [NORMAL], or [ECONOMY].
- 4 To use the flash, Set the [FLASH] on the [RECORDING SETUP] ④ Menu to [ON].
 - At a dark place, ⚡ will be displayed and the Flash will be available. (The display disappears at a bright place.)
- 5 Press the [MENU] Button twice to exit menu.
- 6 Press the Recording Start/Stop Button.
 - The still image is recorded on the Card.

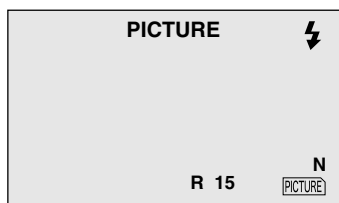
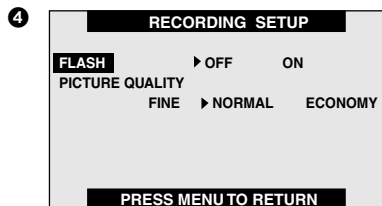
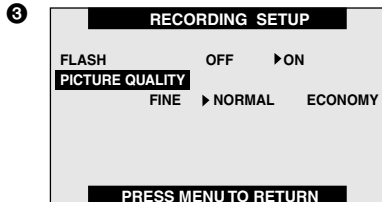
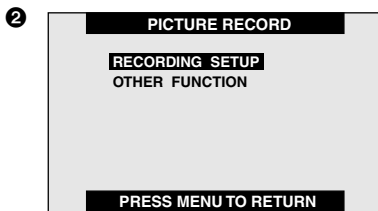
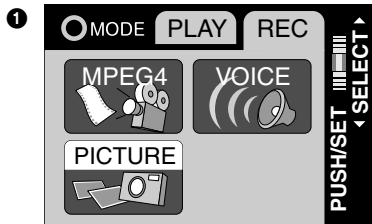

Display in the Still picture mode

PICTURE : Still picture mode
R 0000: Number of remaining recordable pictures
F/N/E: Select a picture quality. ([F]: Fine, [N]: Normal and [E]: Economy)

- The image size is 640 x 480 (VGA).
- If [NORMAL] or [ECONOMY] is selected for recording, mosaic-pattern noise may appear on a playback image depending on the image content.
- The available range of the Flash is approximately 60 to 100 cm in a dark place.
- Record the subject approx.50 cm away from it.
- If the number of remaining recordable pictures is 10,000 or more, the indication will be "9999".
- ⚡ flashes immediately after the Flash is used to indicate that pictures cannot be recorded. Wait until it turns on.
- The following table shows still image storage capacity for each image quality settings:

	Fine	Normal	Economy
8MB	45	95	190
16MB	100	200	400
32MB	220	440	880
64MB	440	880	1760

The numbers shown in the above table are approximate and may vary depending on picture content.

Playing back Still Pictures

Plays back still pictures recorded on the card.

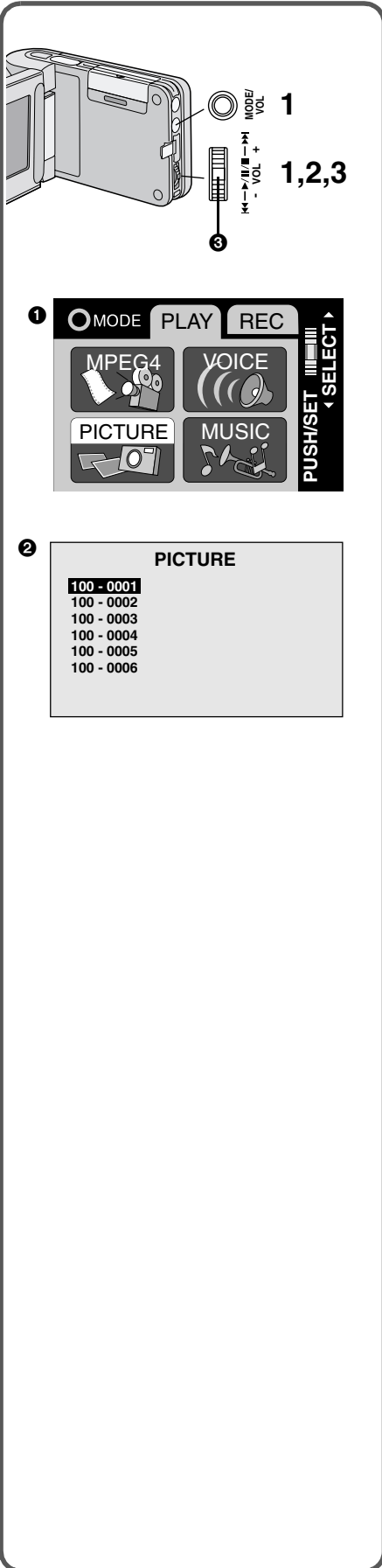

1 Set the Operation Mode to [PLAY>>PICTURE] ❶

- Still picture files recorded on the card are displayed in the form of a list (six files per page) ❷.

2 Move the Jog Lever up or down to select a desired file.

3 Press down the centre of the Jog Lever ❸.

- A still picture file is played back.

■ To stop playback

While playing back, press down the centre of the Jog Lever.

- Playback is stopped and still picture files are displayed in the form of a list.

■ To play the next (previous) file

While playing back, Move the Jog Lever up or down.

- If there is no file to be played, [NO FILE] is displayed.
- Only JPEG formatted files are able to play on your SD Multi AV Device. (In some cases, even such a file may not be played back).

Recording Voice (Voice Recording Function)

You can record voice data on the card.

- 1 Set the Operation Mode to [RECORD>>VOICE] ②.
- 2 Press the Recording Start/Stop Button.
 - Recording starts.
- 3 Speak into the built-in microphone ① of this SD Multi AV Device.

■ To stop recording

While recording Voice, press the Recording Start/Stop Button.

■ Display in the Voice Mode

VOICE : Voice Mode
R:0h00m: Remaining Time Indication

- The LCD Monitor will shut off about 5 seconds after starting to record. This is not a malfunction but a normal sequence in recording. When voice recording stops, the LCD Monitor turns on again.
- To check the voice while recording, use the earphone.
- The recorded file is automatically locked (to prevent accidental erasure).
- The screen shows a simple blue background.
- If the [MODE/VOL] button is pressed while recording, the LCD Monitor turns on and will turn off again in approx. five seconds.
- To check the sound which is being recorded, the Earphone supplied needs to be connected. (Volume adjustment is not available.)
- The indexes of the recording time for Voice files are as follows:

8MB	25 min.
16MB	58 min.
32MB	120 min.
64MB	240 min.

- The times listed in the above table are approximations.

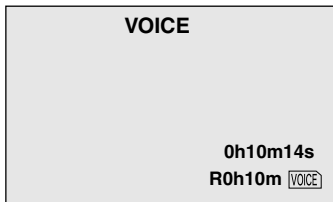
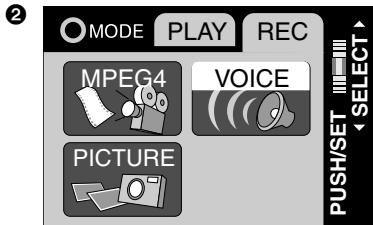
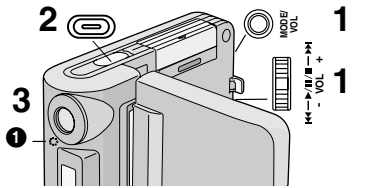

Hearing the Voice Recorded (Playback Sound)

Plays back the voice files recorded by this SD Multi AV Device. Plays back the voice files recorded by this SD Multi AV Device. Wear the Earphone (supplied) to listen to the sound.

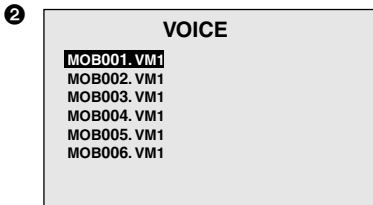
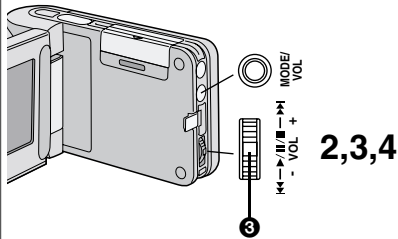
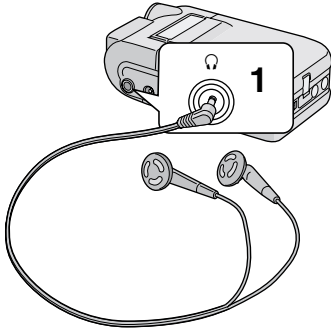

1 Plug the earphone into the [] jack. (→ 21)

2 Set the Operation Mode to [PLAY>>VOICE] ①.

- Voice files recorded on the card are displayed in the form of a list (six files per page) ②.

3 Move the Jog Lever up or down to select a desired file.

4 Press down the centre of the Jog Lever ③.

- A voice file is played back.
- In approx. five seconds after playing back, the Monitor will turn off.
- After playing back, the file list reverts and the LCD monitor turns on again.

■ To stop playback

While playing back, hold down the centre of the Jog Lever for about two seconds.

- Playback is stopped and voice files are displayed in the form of a list.
- Press once, and the playback will pause.

■ Fast forward (fast backward) playback

While playing back, hold down the Jog Lever upwards (downwards).

- Hold down the Jog lever upwards for fast forward playback or downwards for fast backward playback. (Hold down the Jog Lever for about one second or more for 10 times the normal speed or for about seven seconds or more for 60 times.)
- Release the Jog Lever to return to the normal playback.

■ To find the beginning of a voice file:

While playing back, move the Jog Lever up or down.

- When playback begins, the LCD Monitor turns off about 5 seconds later.
- The screen shows a simple blue background.
- If a file is not available, [NO FILE] will be displayed.
- If the [MODE/VOL] button or the Jog Lever is pressed after the LCD Monitor turns off, the Monitor turns on and will turn off again in approx. five seconds.
- The L/R indication on the Earphone represents Left/Right.
- The recorded voice files cannot be played back on PC.

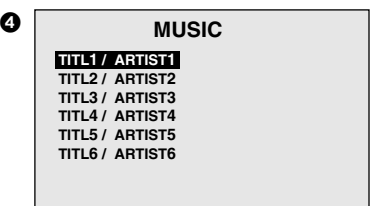
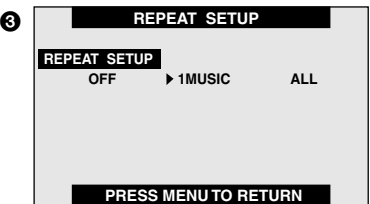
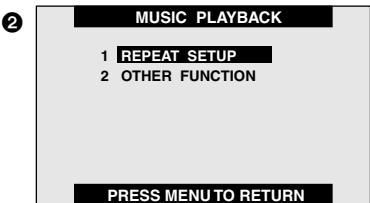
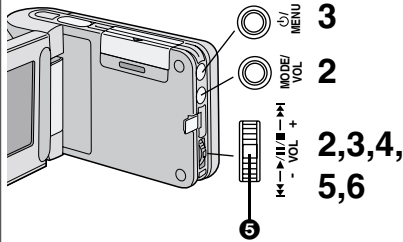
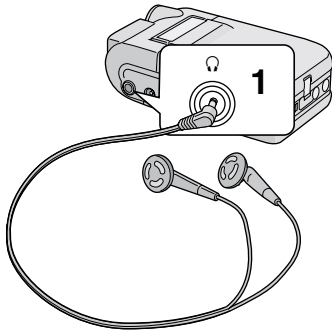

Listening to Music (Music Play)

You can play MPEG-2 AAC format and MP3 data. Music files must be written on the SD Memory Card using a USB Reader/Writer for SD Memory Card (supplied accessory) and the Panasonic Media Manager (supplied accessory) special software programme in order for the SD Multi AV Device to play music. For more detailed information, please refer to the supplied Panasonic Media Manager Basic Operating Instructions. The SD memory card must be formatted using the supplied USB Reader/Writer before using the "Listening to Music (Music Play)". For more specific information regarding formatting the SD memory card, please refer to the supplied Panasonic Media Manager Basic Operating instructions.

- 1 Plug the earphone terminal into the [] jack. (→ 21)**
- 2 Set the Operation Mode to [PLAY>>MUSIC] ①.**
 - Music files recorded on the card are displayed in the form of a list (six files per page).
- 3 Select the [REPEAT SETUP] ②**
- 4 Set the [REPEAT SETTING] to desired settings.③**
 - Select either [1MUSIC] or [ALL]. Select [OFF] when playback is not desired to be repeated.
- 5 Move the Jog Lever up or down to select a desired file ④.**
- 6 Press down the centre of the Jog Lever ⑤.**
 - A music file is played back.
 - In approx. five seconds after playing back, the Monitor will turn off.
 - After playing back, the file list reverts and the LCD monitor turns on again.

To stop playback

While playing back, hold down the centre of the Jog Lever for about two seconds.

- Playback is stopped and music files are displayed in the form of a list.
- Press once, and the playback will pause.

To find the beginning of a music file:

While playing back, move the Jog Lever up or down.

- Only the MPEG2-AAC formatted file and MP3 (data recorded using Panasonic Media Manager) is applicable to play on your SD Multi AV Device.
- Music playback is not possible with a MultiMediaCard.
- A title or artist name may not be displayed in some cases.
- When playback begins, the LCD Monitor turns off about 5 seconds later.
- **Music cannot be heard without connecting the earphone.**
- All music files are locked.
- The SD Multi AV Device can be used as a player only. It cannot record or erase tracks. However, using its Formatting Function, all the data on an SD Memory Card can be erased.
- Only the first 17 characters are displayed for the title/artist name.
- If a file is not available, [NO FILE] will be displayed.

Listening to Music (Music Play) (Cont.)

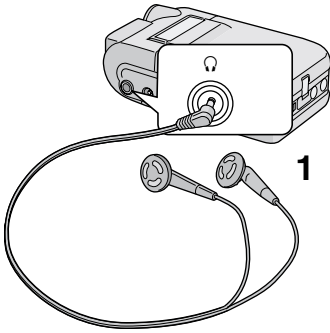

- During playback, the date is not displayed.
- MP3 is the abbreviation for MPEG1 Audio Layer3.
- Normal MP3 files cannot be played back. Use the data created with Panasonic Media Manager.
- Some MP3 or MPEG2-AAC files which were written with Panasonic Media Manager may not be played back.
- The bit rates (recommended) supported are 64 kbps, 96 kbps or 128 kbps for both the MPEG2-AAC and MP3 files.
- The WMA data cannot be played back.
-

Using the Earphone

Since there is no internal speaker, the supplied earphone must be used when hearing the sound or making volume adjustment.

1 Plug the earphone terminal into the [] jack.

- If the voice sound is checked with the Earphone on while recording, the volume adjustment function is invalid.

Adjusting the Volume

Adjusts the playback audio level for moving picture files, music files, and voice files.

1 While playing back, press the [MODE/VOL] Button.

- The [Volume] indication appears ❶.

2 Move the Jog Lever up to increase the audio level or down to decrease it.

3 Press the [MODE/VOL] Button.

- The [Volume] indication disappears.
- If the [MODE/VOL] Button or the Jog Lever is left unoperated for five seconds, the [Volume] indication will automatically disappear.

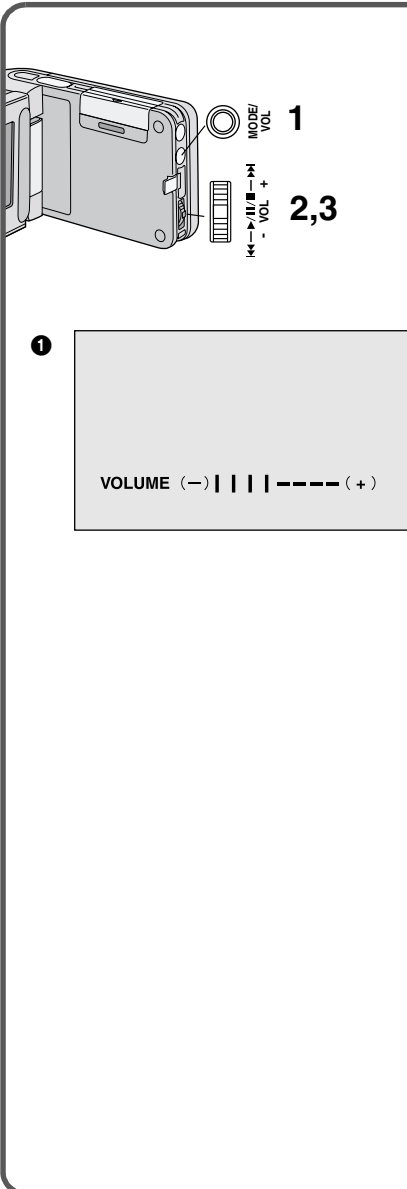

Advanced Functions

Backlight Compensation Function

This prevents a recording subject from being recorded darker in backlight. (Backlight is the light that shines from behind a recording subject.)

- 1 Set the Operation Mode to [REC>>MPEG4] or [REC>>PICTURE] ①.
- 2 Move the Jog Lever up for about 1 second.
 - The [] Indication ② is displayed.

To Resume Normal Recording

Move the Jog Lever up for about 1 seconds.

- When the Backlight Compensation Function is activated, the entire screen becomes brighter.
- Turning the power OFF will release this function.
- It is not possible to use Horizontal Stripes Reduction Mode when this mode is set to ON.
- The backlight may not be sufficiently compensated in dark places.
- The Backlight Compensation Function cannot be set or released while recording.

Adjusting White Balance

The SD Multi AV Device adjusts White Balance automatically. However, depending on the scene or light condition, the Automatic White Balance may not be able to bring out natural colours. In such case, the white balance can be adjusted manually.

- 1 Set the Operation Mode to [REC>>MPEG4] or [REC>>PICTURE] ①.
- 2 Point the SD Multi AV Device at a full-screen white subject (e.g. white paper).
- 3 Keep pressing the centre of the Jog Lever until the [] Indication ② is displayed.

To Resume Automatic Adjustment

Press down the centre of the Jog Lever until the [] Indication ② disappears.

- You may not be able to achieve correct White Balance adjustment manually under weak illumination. (In this case, the [] Indication flashes.)
- Turning the power OFF will release the adjusted White Balance setting.
- This mode cannot be set or released while recording.
- Adjustment of White Balance is effective under the following conditions.
 - When recording under reddish lighting (halogen light bulb, incandescent light bulb, etc.).
 - When recording a picture of mono-tone colour.
 - When recording under multiple lightings

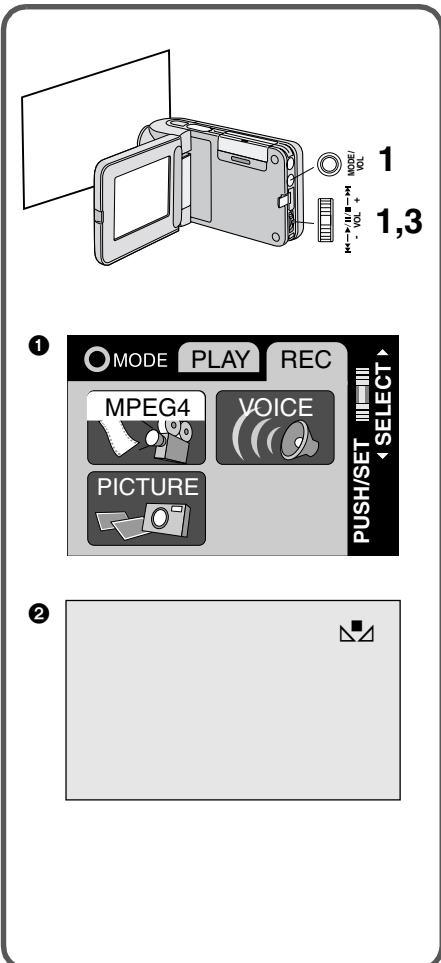
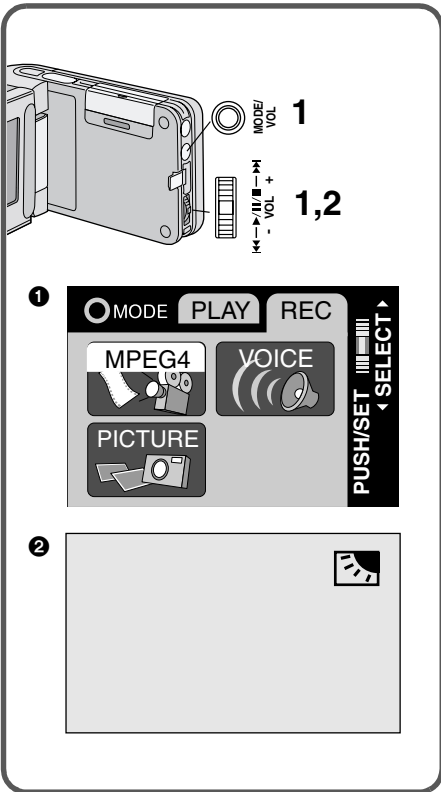

Erasing the Files Recorded on a Card

Using SD Multi AV Device, you can erase the files recorded on a Card. After the file is erased, it cannot be restored.

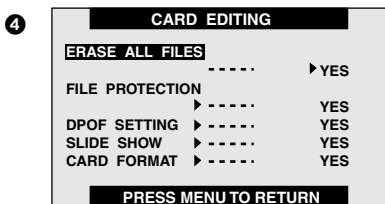
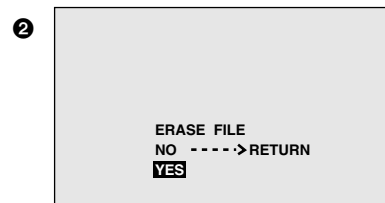
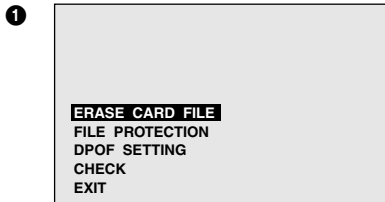
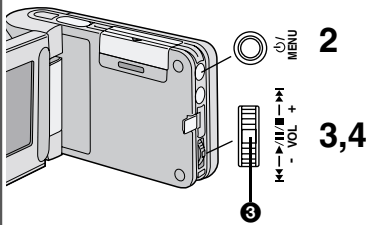

- 1 **Play back the file to be erased or let it pause.**
(→ 15, 17, 19)
- 2 **Press the [MENU] Button.**
 - The [CARD EDITING] screen appears ①.
 - Except for the still picture mode, [DPOF SETTING] and [SLIDE SHOW] is not displayed.
- 3 **Press the Jog Lever downwards/upwards to select [ERASE CARD FILE] and press down the centre of the Jog Lever ③**
 - A verification message appears ②.
- 4 **Move the Jog Lever up or down to select [YES] and press down the centre of the Jog Lever ③**
 - The selected file is erased from the Card.
 - If [NO] is selected, the file selection is cancelled.
 - To abort the [CARD EDITING] screen, select [RETURN].

To erase All Files

- 1 **Set [ERASE ALL FILES] on the [CARD EDITING] ④ Menu to [YES].**
 - A verification message appears.
- 2 **Select [YES].**
- 3 **Press the [MENU] Button twice.**
 - Erased files cannot be restored.
 - This SD Multi AV Device cannot erase any music files (MPEG2-AAC and MP3) (→ 20).
 - Music files (in MPEG2-AAC or MP3 format) cannot be erased on the SD Multi AV Device.
 - The files recorded in the Voice Record mode (see page 18) are automatically locked. Release the lock to erase them.
 - Do not erase the Voice Files recorded with this SD Multi AV Device using other devices.
 - A locked file cannot be erased. Release the lock to erase them.
 - Any file cannot be erased if the write protect switch on the SD Memory Card is set to [LOCK].
 - If a file is erased on the SD Multi AV Device, the DPOF information set on another camera may also be erased.
 - A still picture file (other than JPEG) that cannot be played back on the SD Multi AV Device may be erased.
 - Erasing many files may take a little time. Wait until the ACCESS Lamp goes out.

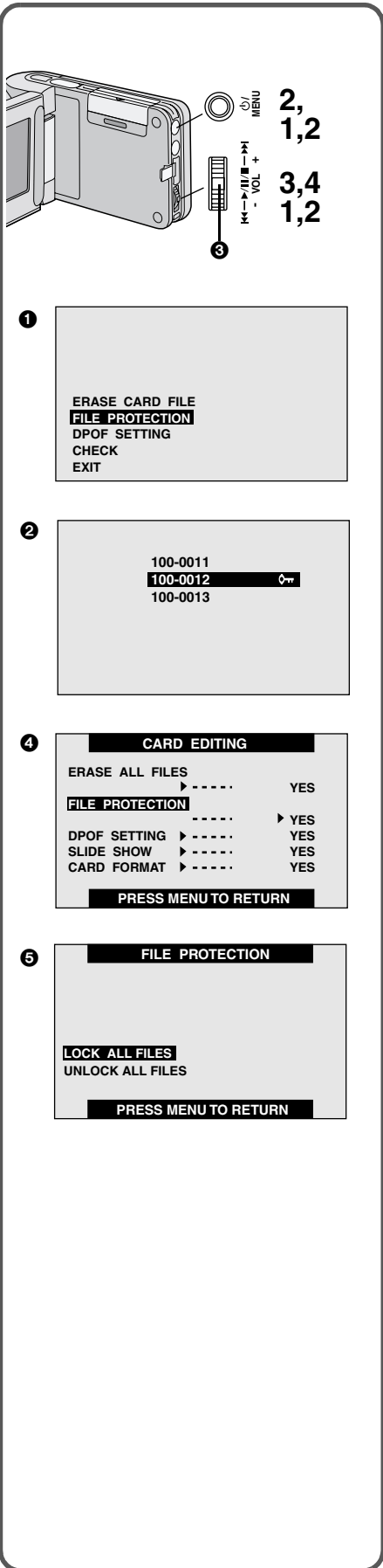

Protecting the file (Lock Setting)

Precious files recorded on a Card can be locked (to prevent accidental erasure).

- 1 **Play back the file to be locked or let it pause.** (→ 15, 17, 19)
- 2 **Press the [MENU] Button**
 - The [CARD EDITING] screen appears ❶.
 - Except for the still picture mode, [DPOF SETTING] and [SLIDE SHOW] is not displayed.
- 3 **Move the Jog Lever up or down to select the [FILE PROTECTION], and press down the centre of the Jog Lever ❷.**
 - The selected file is locked and the [] Indication ❸ is attached to the selected files.
 - Repeat steps 1 through 3 to lock multiple files.

■ To release the lock setting:

Select [UNLOCK] in Step 3.

- the [] Indication disappears.

■ To lock all files:

- 1 **Set the [FILE PROTECTION] on the [CARD EDITING] Menu ❹ to [YES].**
- 2 **Select [LOCK ALL FILES] ❺ .**
 - To unlock all the files, select [UNLOCK ALL FILES].

- Even if files are locked, the files will be deleted when the Card is formatted.
- Any music files (MPEG2-AAC and MP3) cannot be unlocked.
- Files recorded by Voice Recording Functions are automatically locked (to prevent accidental erasure).
- The Lock Setting carried out by this SD Multi AV Device is only effective for this SD Multi AV Device.
- The SD Memory Card has a write protection switch on it. If the switch is moved to the [LOCK] side, you cannot write to or format the Card. If it is moved back, you can.
- If there are many files to be locked (or unlocked), the operation takes a longer time.

Writing Printing Data on a Card (DPOF Setting)

DPOF Setting Printing data (DPOF Setting), such as the number of images to be printed, can be written to the Card.

- 1 Play back a still picture to be DPOF-set.(→ 17)
- 2 Press the [MENU] Button.
 - The [CARD EDITING] screen appears ①.
- 3 Move the Jog Lever up or down to select [DPOF SETTING] and press down the centre of the Jog Lever ③
- 4 Move the Jog Lever up or down to select the number of pictures ② to be printed and press down the centre of the Jog Lever.

- When DPOF setting is set to 1 or more files, the [●] indication ④ appears.

■ To release all the DPOF settings:

- 1 Set the [DPOF SETTING] on the [CARD EDITING] Menu ⑤ to [YES].
- 2 Select [SET ALL TO 0] ⑥.
 - If the [ALL 1] is selected, all the still pictures are set for one DPOF.
 - If the [CHECK] is selected, still pictures that DPOF setting are set can be played back like a Slide Show.

- DPOF is the abbreviation of Digital Print Order Format. DPOF is used to select images you want to print. DPOF can only used with products that support this feature.
- The number of prints can be set from 0 to 99.
- This SD Multi AV Device may not recognize the DPOF set by the other type of device.
- Verifying the DPOF Setting may take a little time. Wait until the ACCESS Lamp goes out.

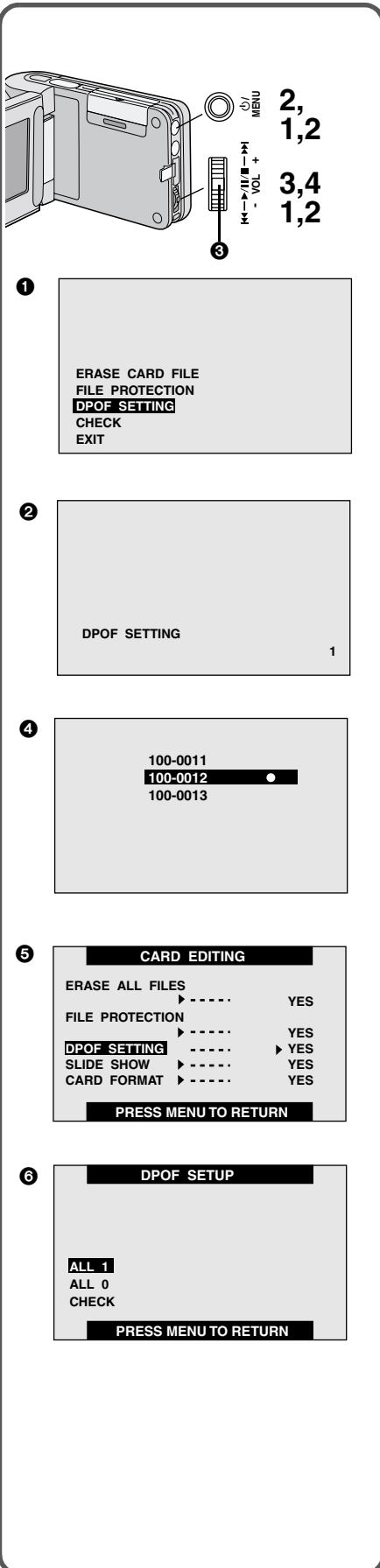

Playing back still pictures one by one (Slide Show)

The recorded still picture in the Card can be played back like a Slide Show.

- 1 Set the Operation Mode to [PLAY>>PICTURE] ①.
- 2 Set the [SLIDE SHOW] on the [CARD EDITING] ② Menu to [YES].

- Slide show starts from the selected still picture.
- All pictures are sequentially displayed, each for about 5 seconds, and the show stops at the last picture.

To cancel the Slide Show:

press down the centre of the Jog Lever ③ for about 2 seconds or more.

- Press down the centre of the Jog Lever once, and the playback will pause.
- Playback time may take longer than usual depending on the picture.
- The order and playback time of a slide show set on another device is not applicable to this SD Multi AV Device (all pictures are played back).

Formatting the Card

If a Card becomes unreadable by the SD Multi AV Device, formatting it may make it reusable. Formatting erases all the data recorded on a Card. If additional cards are purchased it is advisable to format the card before it is used the first time.

- 1 Set the Operation Mode to [PLAY>>MPEG4], [PLAY>>PICTURE], or [PLAY>>VOICE].
- 2 Set the [CARD FORMAT] on the [CARD EDITING] Menu ① to [YES].
 - A verification message appears ②.
- 3 Move the Jog Lever up or down to select [YES] and press down the centre of the Jog Lever ③
 - Formatting is carried out.

- By formatting, all data stored in the Card (e.g., still pictures, MPEG4 moving pictures, voice data, music data) is erased.
- Format the Card on the SD Multi AV Device or on Panasonic Media Manager (supplied). A Card formatted on a machine other than the SD Multi AV Device may not be used. A Card formatted on the SD Multi AV Device may not be used on other machines. Format a Card on the machine on which it is used.
- If the write protection switch of the SD Memory Card is set on [LOCK], data cannot be erased.
- When the Card is formatted, the files will be deleted, even if files are locked.
- As formatting erases all the data, save the necessary data on a personal computer, etc. beforehand.
- Format may take a little time. Wait until the ACCESS Lamp goes out.

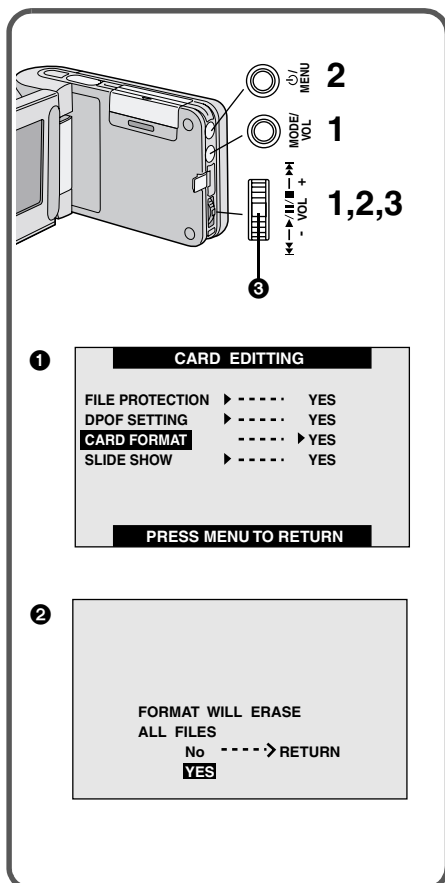
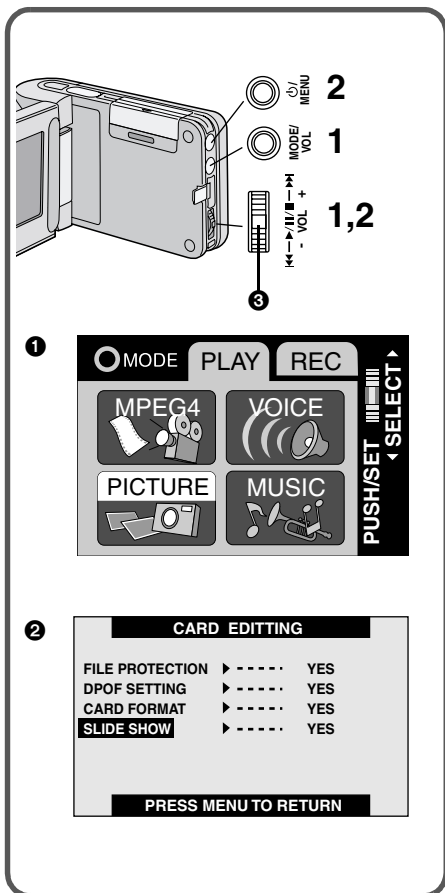

For using SD-MovieStage

-

For using the SD-MovieStage software, refer to the PDF manual. This manual describes installation only.

Operating environment

SD-MovieStage can be installed in a PC/AT compatible personal computer which can run Microsoft® Windows® 98SE/Me/2000 Professional/XP.

Compatible machines:

PC/AT compatible PC with Microsoft Windows® 98 Second Edition/Me/XP/2000 Professional pre-installed.(Intel® Pentium® II 333MHz or higher CPU recommended)

Graphic display:

High Colour (16 bit) or more.

Desktop resolution of 800X600 dots or higher.

Installed memory:

128 MB or more (for Windows® 98SE/Me)

256 MB or more (for Windows® 2000/XP)

Free hard disk space:

400 MB or more

Disk drive:

CD-ROM drive

Ports:

USB Terminal

Other requirements:

Mouse

- Microsoft and Windows are registered trademarks of Microsoft in the United States and other countries.
- Intel Pentium is a registered trademark.
- Other names, company names, and product names printed in these instructions are trademarks or registered trademarks of the companies concerned.
- The contents or complete reproduction or copy of these Operating Instructions could be changed without notice.
-

Installing SD-MovieStage

2



3



4



5



6



7



- 1 Insert the supplied CD-ROM into the personal computer's CD-ROM drive.
- 2 Double-click [My Computer], double-click CD-ROM icon, double-click [SD-MovieStage Ver.1.0E], and double-click [SETUP.EXE].
- 3 Select the Language to be installed and click the [OK] Button.
- 4 Click the [Next] Button.
 - The next screen will be displayed.
- 5 Read License Agreement carefully, and click [Yes] Button, if you accept the terms of the agreement.
 - If [No] Button is selected, you cannot proceed to install.
- 6 Click the [Next] Button.
- 7 Click the [Next] Button.
 - Check that the [PAL] system is selected.

Installing SD-MovieStage (Cont.)



8 Click the [YES] Button.

- The necessary software for the SD-MovieStage is installed.

9 Click [Yes] Button to create the short-cut icon on the desktop.

10 At the end of the Setup, click on the [Finish] Button.

- After rebooting the computer, the SD MovieStage is enabled.
- For the information of the operation of SD-MovieStage, refer to the instruction in the PDF file that was installed together with this software. Adobe® Acrobat® Reader® (refer to <http://www.adobe.com/>) is required to read PDF files.
- The screen image inserted into this manual is captured from English version.

■ Cautions for Windows XP/2000 Professional

When installing or using this software, specify the user name to [Administrator (computer administrator)] or any other user name having the equivalent right. Then log on with that user name to install this software.

(If you don't have such a right, consult with your system administrator).

Starting SD-MovieStage

The step below starts the SD-MovieStage. Please read the PDF-based Instructions for using the SD-MovieStage.

1 Select [Programs] >> [Panasonic] >> [SD-MovieStage] >> [SD-MovieStage] from the Windows start menu.

- SD-MovieStage will start.

- If you use Windows 98SE, install Panasonic Media Manager (supplied accessory) before using the SD-MovieStage.

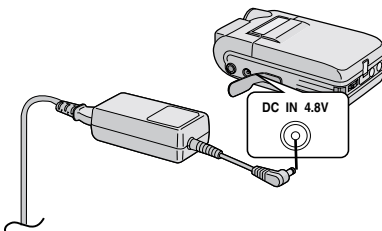

Others

Notes & Precautions

■ Charge the built-in battery for maintaining the date information.

This built-in battery is used for the memory of date and time. If [⌚] is displayed when the power is on, the built-in battery may be exhausted. Charge using the following procedure:

- 1 Take the battery out and plug in the AC adapter (→ 6).**
- 2 Turn the power off and leave this SD Multi AV Device as it is for about 12 hours.**

■ After Use.

- 1 Turn off the SD Multi AV Device.**
- 2 Take out the Card.**
- 3 Detach the power supply and retract the LCD Monitor.**
- 4 Put the SD Multi AV Device into the Carrying Case.**

■ Using a Card in a Personal Computer

- To erase pictures that you recorded on the Card by using the SD Multi AV Device, be sure to erase them on the SD Multi AV Device, not on the computer.
- You may not be able to properly play back on the SD Multi AV Device after editing the recorded data or changing the image data on a personal computer.
- The image data files recorded on the Card with this SD Multi AV Device conform to the DCF (Design Rules for Camera Files Systems) universal standard stipulated by JEITA (Japan Electronics and Information Technology Industries Association).
- Moving Picture format (MPEG4) that can be played back on this device is ASF. (Depending on the file, it may not be able to be played back even if it is in ASF format.)

Constructing a Folder when the Card is used with a PC

- When a Card with data recorded on it is inserted into a personal computer, folders will be displayed as in the figure.

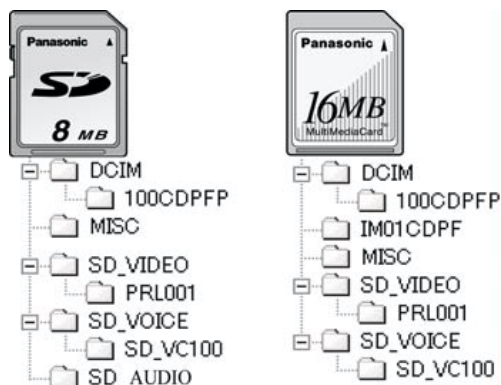

- [100cdpfp]: The images (imga0001.jpg etc.) in this folder are recorded in the JPEG format. ([100-0001] or similar indication is displayed on the SD Multi AV Device.)
- [Misc]: Files in which DPOF Data has been set to the image are in this.
- [SD_VC100] Folder in which the voice data (e.g., MOB0001.VM1) files are stored.
- [SD_AUDIO] Folder in which the music data (e.g., A0B001.SA1) files recorded by the Panasonic Media Manager (supplied accessory) are stored.

- [PRL001]: MPEG4 moving picture is recorded in ASF format (MOL00001.ASF etc.). It can be played back with Windows Media Player (ver.6.4 and later). Because of small size, this File is well suited for transmitting data through a telephone line etc.
- [DCIM], [IM01CDPF], [PRIVATE], [VTF], [SD_VIDEO], [SD_VOICE] etc. are necessary items in the folder structure. They have nothing to do with actual operations.
- The SD Multi AV Device automatically saves file numbers (imga0001.jpg, etc.) along with the images. The file numbers are recorded with each image as a consecutive number.

- The “SD_VOICE” folder and the Voice files in the folder are set as hidden. Depending on the settings of your personal computer, this hidden folder and these hidden files might not appear in Windows Explorer or the “My Computer” screen.
- The memory capacity indicated on the SD Card label corresponds to the total amount of the capacity to protect and manage the copyright and of the capacity available as a conventional memory for a SD Multi AV Device, Personal Computer or others. Capacity that can be used as conventional memory:
8MB Card: about 6,800,000 bytes
- The [SD_VOICE] folder, the voice files contained in it, and [SD_AUDIO] folder are specified to the hidden files. Those folders and files may not be displayed on the Explore and My Computer screen depending on the setting of your PC.
- Do not delete any folders located on the Card. If this is done, the Card may not be recognized on your SD Multi AV Device.
- The MPEG 4 moving picture file (ASF format) can be played on the Windows Media Player (Ver. 6.4 or later). If it cannot be played back, download the appropriate software (G.726). The Windows Media Player contains the auto-downloading feature of this software. Log on the Internet and double-click the MPEG 4 moving picture file. The software will be downloaded automatically. (To play back a file on MacOS, Windows Media Player for Macintosh is required.)
- When formatting a Card, format it on the SD Multi AV Device or on Panasonic Media Manager.
- When a moving picture is played back on a personal computer, a black belt may be present along the top and bottom of the picture.
- If data not supported by the SD Multi AV Device is recorded on a personal computer, it cannot be recognized by the SD Multi AV Device.

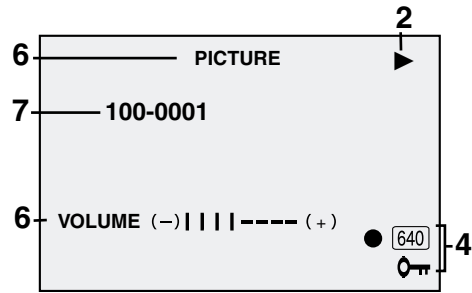
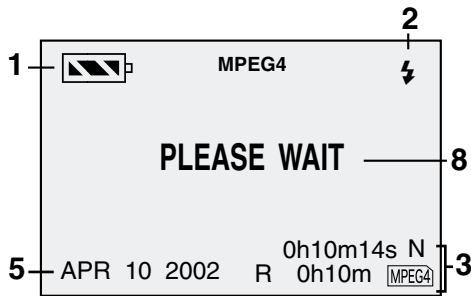

Indications

1) Remaining Battery Power []

When the battery power becomes low, the indication changes. When the battery level indicator indicates [], the battery will run out in a few minutes. Recharge the battery. may be displayed when the AC Adaptor is used. This is not abnormal.

2) Status Indications

Playback Mode

- ▶: Playback (→ 15,19,20,26)
- ||: Still Playback (→ 15,19,20,26)
- ▶▶/◀◀: Cue Playback/Review Playback (Only for sound play back) (→ 19,20)
(10 times speed with 10 ◀◀/▶▶ and 60 times speed with 60 ◀◀/▶▶)

- ↺: Repeat Playback (→ 20)
- SLIDE▶: Slide play back

Recording Mode

- ⚡: Flash (→ 16)
- 1/100,1/120: Horizontal Stripes Reduction Mode (→ 12)
- : Backlight Compensation Mode (→ 22)
- : White Balance setting Mode (→ 22)

3) Card Indication 1

MPEG4

: During recording, this indication is lit in red, and the [ACCESS] Lamp lights. When it is lit in green, recording is not possible. When Remaining Time Indication is [R:0h00m], it flashes in red. When no card is inserted, the indication flashes in red.

R:0h00m: Remaining Time Indication

F/N/E1/E2: Shows the picture quality. [F]: Fine, [N]: Normal, [E1]: Economy and [E2]: Economy 2.

PICTURE

: During recording, this indication is lit in red, and the [ACCESS] Lamp lights. When it is lit in green, recording is not possible. When Remaining Time Indication is [R:0h00m], it flashes in red. When no card is inserted, the indication flashes in red.

0000: Number of remaining recordable pictures

F/N/E: Select a picture quality. [F]: Fine, [N]: Normal and [E]: Economy

VOICE

: During recording, this indication is lit in red, and the [ACCESS] Lamp lights. When it is lit in green, recording is not possible. When Remaining Time Indication is [R:0h00m], it flashes in red. When no card is inserted, the indication flashes in red.

R:0h00m: Remaining Time Indication

4) Card Indication 2

- : DPOF setting (setting for more than 1 print) (→ 25)
- [00]: Number set DPOF (→ 25)
- []: LOCK setting (→ 24)
- : Picture size
When you play back a scene recorded on the SD Multi AV Device with a picture size specification different from the one stated above, the following indications should be displayed. If the size of the picture is from 640 pixels to 800 pixels, the indication will be displayed; if picture size is 640 pixels or lower, the scene should be displayed without any indication of picture size.
- : From 800 to 1024
- : From 1024 to 1280
- : From 1280 to 1600
- : Above 1600 pixels

5) Date/Time Indication (→ 10)

6) Volume (→ 21)

- Use this indication to adjust the volume of playback sound from the earphone.

7) File Name Display (→ 15, 17, 19, 20)

8) Displayed by the text

[LOW BATTERY]:

The battery may be exhausted. Replace it with fully charged battery.

[NO CARD]:

The Memory Card is not inserted. Otherwise, the Card may not be inserted correctly.

[CARD FULL]:

The memory capacity is fully utilized. Erase any unnecessary files or replace it with a new card.

[CARD LOCKED]:

The write enable switch of the SD Memory Card is set to [LOCK] (see page 24).

[CHECK CARD]:

Re-insert the Card. If [CHECK CARD] is still displayed, the Card is not compatible or applicable. This SD Multi AV Device cannot recognize it. Format it (→ 26).

[FILE LOCKED]

You attempt to execute the erase operation on a locked Card.

[UNPLAYABLE CARD]

This data is not valid for playback.

[PLEASE RE-OPERATE]:

Press the power button for 5 seconds or longer if playback or recording cannot be controlled or the screen freezes. If the power remains, remove the battery off or unplug the power cord.

■ Cautions for Use

When you use your SD Multi AV Device on a rainy or snowy day or on a beach, make sure that no water or moisture enters the SD Multi AV Device.

- Water may cause the SD Multi AV Device or card to malfunction. (Irreparable damage may occur.)
- If sea water splashes onto the SD Multi AV Device, wet a soft cloth with tap water, wring it well, and use it to wipe the camera body carefully. Then, wipe it again thoroughly with a soft dry cloth.

Keep the SD Multi AV Device away from magnetized equipment (such as a microwave oven, TV, video game equipment, etc.).

- If you use the SD Multi AV Device on or near a TV, images or sounds may be disturbed due to electromagnetic wave radiation.
- Do not use near a cell phone because doing so may cause noise to adversely affect the picture and sound.
- Recording on the card may be damaged, or images may be distorted by strong magnetic fields created by speakers or large motors.
- Electromagnetic wave radiation generated by a microprocessor may adversely affect the SD Multi AV Device, causing the disturbance of images and sounds.
- If the SD Multi AV Device is affected by magnetically charged equipment and does not function properly, turn off the SD Multi AV Device power and detach the Battery or AC Adaptor and then connect the Battery or AC Adaptor again. Thereafter, turn on the SD Multi AV Device power.

Do not use your SD Multi AV Device near radio transmitters or high-voltage lines.

- If you record pictures near radio transmitters or high-voltage lines, recorded images or sounds may be adversely affected.

Do not use this SD Multi AV Device for surveillance purposes or other business use.

- If you use the SD Multi AV Device for a long period of time, the internal temperature increases and, consequently, this may cause malfunction.
- This SD Multi AV Device is not intended for business use.

When you use your SD Multi AV Device on a beach or similar place, do not let sand or fine dust get into the SD Multi AV Device.

- Sand or dust may damage the SD Multi AV Device. (Extra care should be taken when inserting and removing the Card.)

Do not spray insecticides or volatile chemicals onto the SD Multi AV Device.

- If the SD Multi AV Device is sprayed with such chemicals, the camera body may be deformed and the surface finish may peel off.
- Do not keep rubber or plastic product in contact with the SD Multi AV Device for a long period of time.

Do not use benzine, thinner or alcohol for cleaning the SD Multi AV Device.

- The camera body may be deformed and the surface finish may peel off.
- Before cleaning, detach the Battery or pull out the AC Mains Lead from the AC Mains socket.
- Wipe the SD Multi AV Device with a soft dry cloth. To remove stubborn stains, wipe with a cloth that is soaked in a detergent diluted with water, and afterward, finish wiping with a dry cloth.
- For storing or transporting the SD Multi AV Device, place it in a bag or case lined with soft pads to prevent the coating on the camera body from being worn.

After use, be sure to take the Card out and detach the Battery from the SD Multi AV Device or pull out the AC Mains Lead from AC Mains socket.

- If the Battery is left on the SD Multi AV Device for a long time, the voltage drops excessively, and the Battery may not function even after it is recharged.

About the Lens

When the Lens is Fogged up:

Turn off the SD Multi AV Device and leave the SD Multi AV Device in this condition for about 1 hour. When the lens temperature becomes close to the ambient temperature, the fog disappears naturally.

About the AC Adaptor

- If the Battery is warm, charging takes longer time than usual.
- If you use the AC Adaptor near a radio, radio reception may be disturbed. Keep the AC Adaptor 1 metre or more away from radio.
- After use, be sure to pull out the AC Mains Lead from the AC Mains socket. (The SD Multi AV Device consumes approx. 0.5 W of power when it is turned off simply by the [] Button.)
- Keep the electrodes of the AC Adaptor and Battery clean at all times.
- Remove the battery if the device is left unused for a long time.
- The temperature of the SD Multi AV Device and the battery may rise while charging the battery. Such rise of temperature does not indicate a fault.
- Do not install, remove, plug or unplug the battery or power cord while the power is on.

About the LCD Monitor

- In a place with drastic temperature changes, condensation may form on the LCD Monitor. Wipe it with soft dry cloth.
- If your SD Multi AV Device is extremely cold when you turn its power on, the image on the LCD Monitor will be slightly darker than usual at first. However, as the internal temperature increases, it goes back to the normal brightness.

Extremely high precision technology is employed to produce the LCD Monitor screen featuring a total of approximately 110,000 pixels. The result is more than 99.99% effective pixels with a mere 0.01% of the pixels inactive or always lit. However, this is not a malfunction and does not affect the recorded picture.

Optimal Use of the Battery

Battery Characteristics

This Battery is a rechargeable lithium ion battery. Its ability to generate power is based upon the chemical reaction that takes place inside it. This reaction is susceptible to the surrounding temperature and humidity, and, if the temperature is too high or too low, the operating time of the Battery becomes shorter. If the Battery is used in an extremely cold environment, the Battery may operate only for about 5 minutes. If the Battery becomes extremely hot, a protective function may operate, and the Battery may become unusable for a while.

Be Sure to Detach the Battery after Use

Be sure to detach the Battery from the SD Multi AV Device. (If it is left attached to the SD Multi AV Device, a minute amount of current is consumed even when the SD Multi AV Device power is off.) If the Battery is left attached to the SD Multi AV Device for a long time, over discharge takes place. The Battery may become unusable after it is charged.

Disposing of an Unusable Battery

- The Battery has a limited life.
- Do not throw the Battery into fire because it may cause an explosion.

Always Keep the Terminals of the Battery Clean

Prevent the terminals from getting clogged with dirt, dust, or other substances.

If you drop the Battery accidentally, check to see if the Battery body and terminals are deformed.

Attaching a deformed Battery to the SD Multi AV Device may damage the SD Multi AV Device.

■ Notes on the SD Memory Card Write-Protect Switch

- The SD Memory Card has a write-protect switch. Sliding the switch to [LOCK] prevents the recording of data to the card as well as the deletion of data from the card. Sliding back the switch permits such operations.

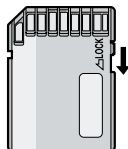

■ Cautions for Storage

Before storing the SD Multi AV Device, take the Card out and detach the Battery.

Store all the components in a dry place with a relatively stable temperature.
(Recommended Temperature: 15 to 25°C, Recommended Humidity: 40 to 60%)

SD Multi AV Device

- Wrap it with a soft cloth to prevent dust from getting into the SD Multi AV Device.
- Do not leave the SD Multi AV Device in places that expose it to high temperature.

Battery

- Extremely high temperatures or low temperatures will shorten the life of the Battery.
- If the Battery is kept in smoky or dusty places, the terminals may rust and cause malfunctions.
- **Do not allow the Battery terminals to come in contact with metal objects (such as necklaces, hairpins, etc.) This can result in a short circuit or heat generation and, if you touch the Battery in this condition, you may be badly burned.**
- Store the Battery in a completely discharged state. To store the Battery for a long period of time, we recommend you charge it once every year and store it again after you completely use up the charged capacity.

Card

- When the Card is being read, do not remove the Card, turn off the power, or subject it to vibration or impact.
- Do not leave the Card in places where there is high temperature or direct sunlight, or where electromagnetic waves or static electricity are easily generated.
- Do not bend or drop the Card. The Card or the recorded content may be damaged.
- After use, be sure to remove the Card from the SD Multi AV Device.
- After usage, store the supplied SD Memory Card in the enclosed bag.
- Do not touch the terminals on the back of the Card with your fingers. Do not allow dirt, dust or water to enter it.

■ Fogging of lens

Turn off the power and leave the SD Multi AV Device as it is for an hour or so. When a temperature equilibrium is reached, the fogging will naturally disappear.

■ State of Power Lamp while charging

The Power Lamp flashes while charging. (Flashes approx. every two seconds when charging is normal.)

When the Power Lamps flashes more quickly or slowly (or turns off), some abnormality may have happened. The flashing speed suggests the following states.

Flashing approx. every 0.5 seconds:

- The SD Multi AV Device, battery or AC adaptor may be defective. Contact your nearest Panasonic dealer.

Flashing approx. every six seconds:

- The ambient temperature or that of the battery itself is too high or too low. Charging proceeds, but will take a longer time.

Turning off:

Charging is completed.

If the Power Lamp turns off when charging is not completed, the following reasons are probable.

- The ambient temperature or that of the battery itself is too high or too low. Wait until the proper temperature is reached and charge the Battery again.
- The AC Adaptor is probably defective. Contact your nearest Panasonic dealer.

Before Requesting Service

If the trouble persists even when the action suggested below has been taken, press the the [ϕ] Button to turn off the power and disconnect and re-connect the Power Cable. Consult your dealer.

Power

- 1: **The SD Multi AV Device power cannot be turned on.**
 - 1: Is the power source connected correctly?
- 2: **The SD Multi AV Device power shuts off automatically.**
 - 2: If you do not use the SD Multi AV Device for more than 10 minutes, the power shuts off automatically to save the Battery power.
- 3: **The SD Multi AV Device power does not stay on long enough.**
 - 3-1: Is the Battery low? Charge the Battery or attach a fully charged Battery.

Battery

- 1: **Battery runs down quickly.**
 - 1-1: Is the Battery fully charged? Charge it with the AC Adaptor.
 - 1-2: Are you using the Battery in an extremely cold place? In cold places, the operating time of the Battery becomes shorter.
 - 1-3: Has the Battery worn out? If the operating time is still short even after the Battery is fully charged, the Battery has worn out.

2:

Recording

- 1: **Recording does not start although power is supplied to the SD Multi AV Device and the Card is correctly inserted.**
 - 1: Is the SD Multi AV Device power turned on?
 - 1-1: Is the [ϕ] Lamp on? If the [ϕ] Lamp is not on, no recording function can be operated.
 - 1-2:

Playback

- 1: **Sound is not played back from the earphones.**
 - 1: Is the volume too low? During playback, keep pressing the [MODE] Button until the [VOLUME] Indication appears. Then, press the [MODE] Button to adjust the volume.
- 2: **Recorded images are not clear.**
 - 2: Is [PICTURE QUALITY] on the [CARD SETUP] Sub-Menu set to [NORMAL] or [ECONOMY]? If recording is done with it set to [NORMAL] or [ECONOMY], images with fine details may include a mosaic-like pattern. Set [PICTURE QUALITY] to [FINE].
- 3: **Playback images do not look normal.**
 - 3: The picture may be damaged. In order to prevent the loss of image data, backing up on a personal computer is recommended.
- 4: **During Playback an [×] Indication is displayed.**
 - 4: The data was either recorded in a different format, or data is damaged.
- 5: **Even if a Card is formatted, it cannot be used.**
 - 5: Either the SD Multi AV Device or the Card may be damaged. Please consult a dealer.
- 6: **Playing back or recording do not function and the screen has frozen.**
 - 6: Press and hold the power button until the power is turned off. If the power still remains after 5 seconds

passed, remove the battery or unplug the AC adapter.

- 7: **Sound is not heard with the Earphone connected while a still picture is played back.**
 - 7: Sound is not presented in the Still Picture mode (recording or playing back of still pictures).
- 8: **How do I send an MPEG4 moving picture recorded as e-mail?**
 - 8: Capture the moving picture data recorded on the SD Multi AV Device onto a personal computer and attach it to an e-mail to send it. In this case, it is recommended to make a file size 1 MB or less. The recording time of 1 MB MPEG4 moving picture is approx. 15 seconds (Fine), 20 seconds (Normal), 45 seconds (Economy 1) or 60 seconds (Economy 2). (The capacity limit of the file which is attachable to an e-mail differs depending on the environment used.) If the file is played back on Macintosh®, use the Windows Media Player for Macintosh®. (MacOS® 8.0 or later) The Windows® Media Player for Macintosh® can be downloaded from Microsoft's home page.
- 9: **Red, blue, green or white dots appear on the screen.**
 - 9-1: 0.01% or less of the pixels of some LCD monitors may remain turned on or off.
 - 9-2: If the SD Multi AV Device is used continuously for a long time or used at a high ambient temperature, red, blue, green or white dots may appear on the screen and be recorded on a still picture. This is due to the rise of the temperature inside the body. This is caused by a characteristic of the C-MOS sensor and is not a failure. Under this condition, turn the SD Multi AV Device off and leave it for a while.
 - C-MOS sensors are said to be a next-generation image pick-up device succeeding CCDs as they are small and consume low power.

Specifications

SD Multi AV Device

Information for your safety

Power Source:	DC 4.8 V (AC Adaptor)
Power Source:	DC 3.7 V (Battery)
Power Consumption:	Recording 3.1W (When using the AC Adaptor) 2.8 W (When using the battery)

Image Sensor:	1/4-inch C-MOS Image Sensor
Lens:	F3.6, Focal Length; 3.88 mm Shortest Image Distance; Approx. 50 cm from Lens
Monitor:	2.0-inch LCD
Microphone:	Mono
Standard Illumination:	1400 lx
Minimum Required Illumination:	120 lx
Recording Media:	MultiMediaCard, SD Memory Card
Image Compression:	JPEG (VGA)
Video Compression:	MPEG4 Fine; 320×240 dot Normal; 176×144 dot Economy1; 176×144 dot Economy2; 176×144 dot
Voice Compression:	G.726
Music Expansion:	MPEG2-AAC, MP3
Dimensions:	Approx. 28 (W)× 50 (H)× 87 (D) mm
Weight:	Approx. 98 g(without Battery and Memory Card) Approx. 125 g(with Battery and SD Memory Card)
Operating Temperature:	0 °C–40 °C
Operating Humidity:	10%–80%

AC Adaptor

Information for your safety

Power Source:	AC 110–240 V, 50/60 Hz
Power Consumption:	7.0 W
DC Output:	DC 4.8 V, 1 A

Dimensions:	Approx. 40 (W)× 26 (H)× 75 (D) mm
Weight:	Approx. 75 g

Battery Pack

Information for your safety

Nominal Voltage:	3.7V
Nominal Capacity:	900 mAh

Dimensions	Approx. 36(W)×7(H)×53(D) mm
Weight	Approx. 27 g



BZ02

ИНФОРМАЦИЯ О СЕРТИФИКАЦИИ ПРОДУКЦИИ

БЛОК ПИТАНИЯ
ДЛЯ ИНФОРМАЦИОННОЙ ТЕХНИКИ

МОДЕЛЬ VSK0621 Panasonic

сертифицирован ОС ГОСТ-АЗИЯ,

(Регистрационный номер в Госреестре — РОСС SG.0001.11BZ02)

Сертификат соответствия:	№ РОСС CN. BZ02.B03196
Сертификат соответствия выдан:	10 января, 2002 года
Сертификат соответствия действителен до:	10 января, 2005 года
Модель VSK0621 Panasonic соответствует требованиям нормативных документов:	ГОСТ Р50377-92 (МЭК 950-86) ГОСТ Р 51318.22-99, ГОСТ Р 50839-2000,
Срок службы	7(семь) лет

Информация для покупателя

Название продукции:	Аудио-Видео SD-устройство
Название страны производителя:	Япония
Название производителя:	Мацусита Электрик Индастриал Ко., Лтд.
Юридический адрес:	1006 Кадома, Осака, Япония
Дата производства: Вы можете уточнить год и месяц по серийному номеру на табличке. Пример маркировки — Серийный номер № G2XXXXXXX (X-любая цифра или буква) Месяц: Первая цифра серийного номера (А — Январь, В — Февраль, ...L — Декабрь) Год: Вторая цифра серийного номера (2 — 2002, 3 — 2003, ...)	
Дополнительная информация:	Пожалуйста внимательно прочитайте инструкцию по эксплуатации.



VQT9775

F0202Mk0(0000 (A))



Matsushita Electric Industrial Co., Ltd.

Web site: <http://www.panasonic.co.jp/global/>