

# Ikelite Digital Housing

instruction manual

for

#6242.95 Canon S95  
ULTRAccompact Digital Housing

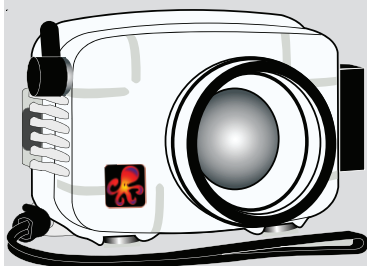

## Please Read

We suggest that you read this instruction booklet thoroughly before use. If you are new to underwater photography be sure to read the General and Photo Tips.

We also suggest that you read the camera manual thoroughly to have a full understanding of where each camera control is located and what function each control provides.

## Initial Camera Setup

- Set camera mode switch to "Av" Aperture Priority.
- Set White Balance to auto "AWB".
- Set Light Metering to "Center-Weighted Avg."
- Set ISO to 80.
- Set Flash to forced ON (flash always fires) "Lightning Bolt".
- Set Review to "5 Seconds".
- Set AF-assist beam to "Off".
- Set Red-Eye Correction and Red-Eye Lamp to "Off".
- Set AF Frame to "Center" and Servo AF to "Off".
- Set AF-Point Zoom to "Off".
- If the "Shortcut/Print" button is **not** assigned, functions of the rear control dial can be accessed through the housing by holding down the "Shortcut/Print" button and using the left/right buttons of the rear control cluster.
- The camera does NOT operate with TTL "automated" flash when in the "M" manual mode. "M" manual mode should NOT be used with the AF35 strobe.

## Canon S90 Note:

The Canon Powershot S90 camera body varies slightly by camera thickness and pushbutton placement. Rear and top pushbutton controls will be slightly off-center but operational when using the S90 camera in the S95 housing.

2

## Camera Setup (cont.)

- You can assign different camera functions such as ISO, WB, Metering, AEL, and AFL to the "Short Cut" button and then change those settings using the arrow buttons. Refer to your camera owner's manual for additional information.
- In Manual mode, the Control Ring will operate the aperture setting. Press the Ring Function button and set to +/- / Tv to change shutter speed; set to "STD" to adjust aperture.
- Camera functions can be assigned to the Control Ring by pressing the Ring Function button. Additional functions include ISO, +/-Exp./Tv, MF Manual Focus, WB white balance, and Step Zoom. Depress the Ring Function button until the desired function is highlighted in the camera LCD screen. Once the function is highlighted, it can be adjusted using the Control Ring.

## Attaching Control Ring Gear (see illustration below)

Press the supplied Control Ring Gear over the camera's control ring before installing the camera in housing. The gear is a "press fit" and goes on either way. Make sure to test it's function once installed.

When installing the camera in housing, make sure that the Control Ring gear meshes properly with the housing gear.

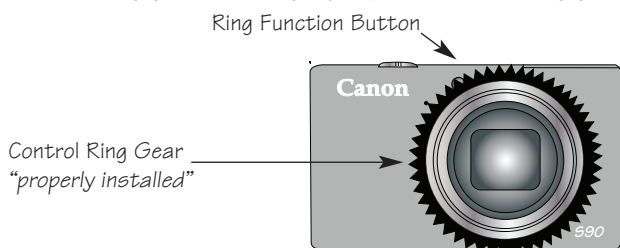

3 Camera Illustration

## Opening the Housing

1. Depress opposing latch buttons simultaneously to open the housing. Once the latch is unlocked, rotate the latch handle away from the housing until it stops. This motion will also break the housing o-ring seal and open the housing back slightly. NOTE: Latch must be rotated to the fully open position to assure easy opening of the back. Rotate the hinged back to its open position.

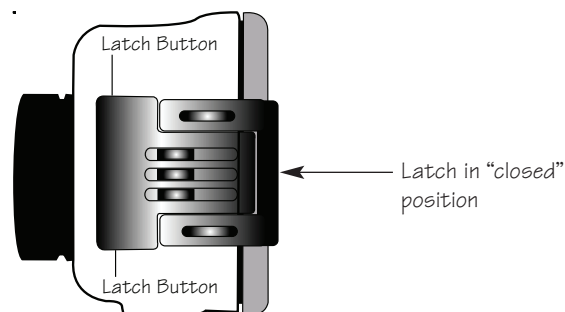
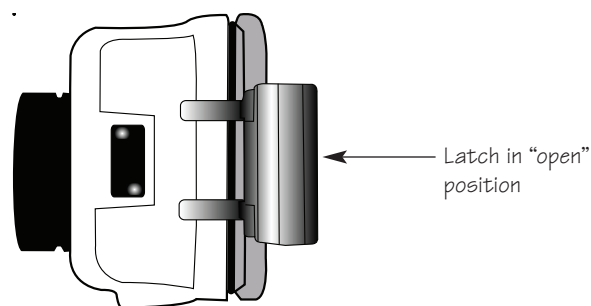

4

## Installing the Camera

1. Place the camera face down into the front housing ribs as shown.

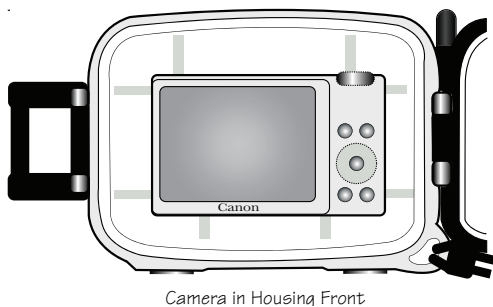

## Closing the Housing

1. Place housing face down in your lap or on a flat surface.
2. Check to see that there is an o-ring on the housing back and that it is clean, lightly lubed, and in its proper location.

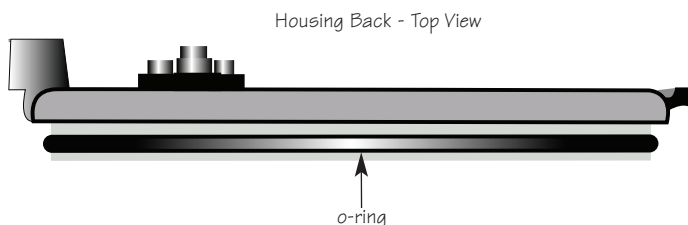

3. Rotate the hinged back onto the housing front. Close the latch and make sure it locks. Latch will "click" into its locked position. Latch buttons will NOT be depressed when latch is properly locked.

5

## Closing the Housing

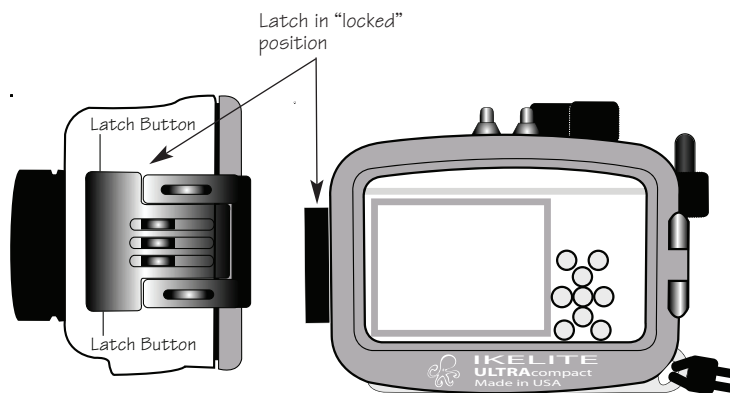

## Check Main O-ring Seal and Controls

Once the housing has been closed, look at the main housing o-ring seal from the "top view" as seen on page 4. Rotate the housing 360 degrees and note the o-ring seal by looking through the clear housing. A good seal should appear as a solid black line.

## Housing Controls

Make sure the housing controls line up with the camera controls. Turn the camera on and operate each of the housing controls to get a feel for using the camera in the housing. Take a few pictures above water with the camera in the housing.

- All camera controls are accessed except the rear Control Dial. Use arrow pad instead to change menu settings.

6

## Housing Controls (cont.)

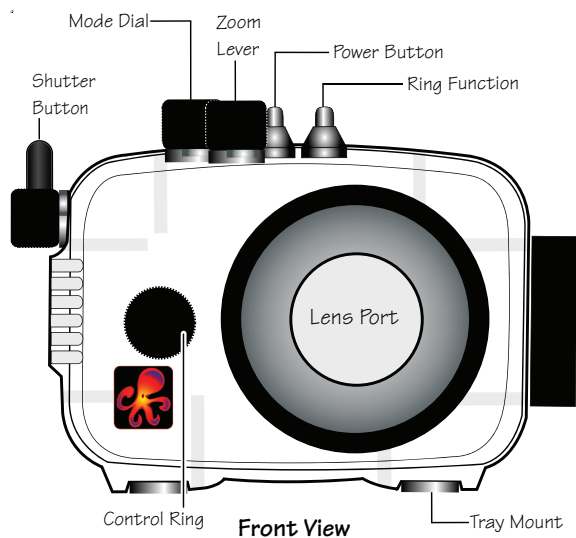

Zoom Control: After you have used the housing's zoom control,

it must be returned to the center position to disengage. If the housing zoom control is pushing the zoom lever in either direction, you may not be able to take a picture or access other functions. This is because the camera is receiving a signal from the engaged zoom control.

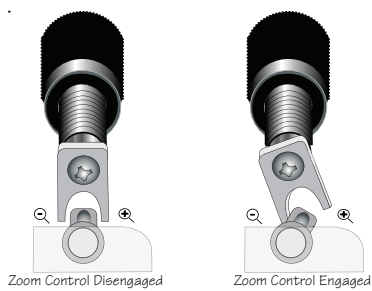

7

## Housing Controls (cont.)

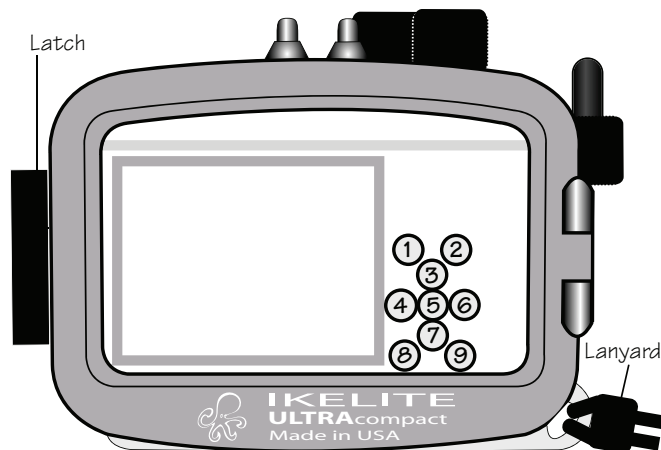

- |               |               |                  |
|---------------|---------------|------------------|
| [1] Short Cut | [4] Macro/MF  | [7] Single Erase |
| [2] Playback  | [5] FUNC./SET | [8] Display      |
| [3] +/-       | [6] Flash     | [9] Menu         |

## Back View

## Using the Camera's Built-in Flash

For the best results, we recommend using an external Ikelite Substrobe. If you do not have an external flash, the camera's built-in flash can be used. This use is limited due to the housing port blocking a portion of the built-in camera flash. See Diffuser/Deflector Installation (page 9).

NOTE: The camera's built-in flash cannot be used with optional Wide-Angle or Accessory lenses.

8

## Diffuser and Deflector Installation

A diffuser and deflector are included with the housing. The diffuser is white transparent plastic. The deflector is also white but is not transparent.

To install the diffuser or deflector, simply push the Cut-out Section into the port groove until it stops. The white plastic should be placed in front of the camera flash as shown below.

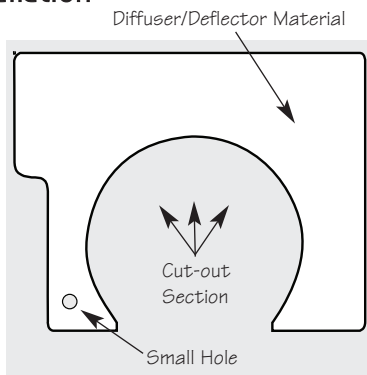

Note the Small Hole. To avoid losing the diffuser/deflector, you can attach a fishing line or string to this hole.

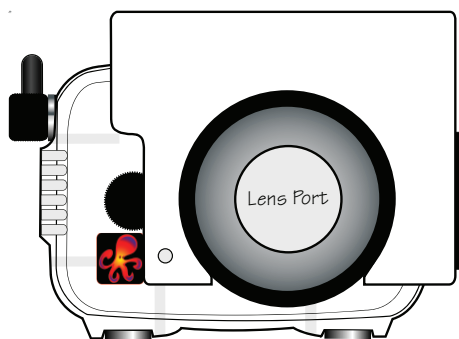

Housing shown with Deflector installed.

9

## Optional Accessories

### Ikelite Lube #5020 (4 - 1cc tubes)

For light lubrication of the main housing o-ring.

### Main Housing O-ring #0132.45

O-rings last for several years if properly maintained (See maintenance). Always carry a spare in case your housing o-ring becomes damaged or lost.

### Additional Control Ring Gear #0099.23

Backup Control Ring Gear for the camera lens.

### UR/Pro Filter (Blue Water) #6441.41 (3" port)

The UR/Pro underwater color correcting filter is designed to restore some of the warm colors filtered out by the water. For available light use only; not recommended for use with flash.

### Green Water Filter #6441.81 (3" port)

Enhances contrast and alters the color of green water to give your subject a rich, natural tone. For available light use only. Not recommended for use with flash.

11

## Diffuser

The diffuser should be installed when using the camera's built in flash. When shooting with the camera's built-in flash at approximately 2 feet (0.6 m) or less, the lens port on the housing will block a portion of the light from the camera's built-in flash, creating a shadow in the lower right area of the photo. Zoom the lens to eliminate the shadow (*You can test this above water*).

## Deflector

The deflector should be installed when using an external strobe such as the AF35, DS51, DS160, DS161 or DS200 Substrobe with an EV Controller. The deflector will redirect the camera's flash to the slave unit or EV Controller which controls the external strobe's output.

## Lens Port

Treat the glass in the lens port as a camera lens. After use, rinse and gently dry the outside lens port to avoid water spotting. To clean, use a mild soap solution or lens cleaner. Do not rinse the inside port glass. *Do not use alcohol or window cleaner on the Lens Port.*

## Lubricants

1. Ikelite provides silicone lubricant with the housing. We recommend you use only Ikelite lubricant on Ikelite products. Other brands may cause the o-ring to swell and not seal properly.
2. Use only enough lubricant to lightly cover the main housing o-ring. Wipe off any excess lubricant with a clean cloth. Lubricant is not a sealant, it is used to reduce friction. Excessive lubricant can collect sand and dirt which may interfere with proper sealing.

**CAUTION: Never use spray lubricants as the propellant ingredient can cause the plastic housing to crack.**

10

## Optional Accessories (cont.)

### Ikelite Digital Strobe Packages

For the best photo results in all shooting conditions, Ikelite highly recommends that you use an external digital strobe. Ikelite strobes are much more powerful, recycle more quickly, and eliminate backscatter created by the camera's built-in flash. Strobe packages come complete with the strobe, arm, and slave unit (to sense the camera flash).

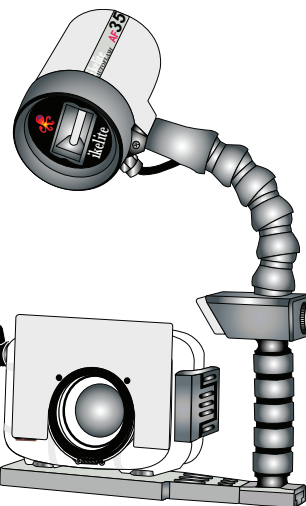

The addition of an external strobe to your housing will help eliminate particles in the water that are "lit-up" by the camera flash, commonly called backscatter. A second strobe will eliminate shadows and add more depth to your subjects.

The #4035 AF35 AutoFlash Kit strobe package is designed specifically for the Ikelite Compact and ULTRAcompact Digital housings.

### AF35 AutoFlash Kit includes:

- AF35 strobe
- Flex arm
- AutoFlash sensor
- Handle with rubber grip
- Tray (single or dual)
- Mounting hardware

12

## Optional Accessories (cont.)

### Recommended Strobe Packages

**AF35 Autoflash Kit #4035.**

**DS51 Substrobe Flex Package #3944.49** includes #4087.1 Flex Arm System with EV Manual Controller.

**DS51 Substrobe Deluxe Package #3944.54** includes #4086.61 SA-100 Arm System with EV Manual Controller.

**DS160 Substrobe Package #3944.91** includes #4086.61 SA-100 Arm System and 1.5 hour Smart Charger with EV Manual Controller.

**DS161 Movie Substrobe Package #3945.03** includes #4086.61 SA-100 Arm System and 1.5 hour Smart Charger with EV Manual Controller.

**DS200 Substrobe #4062.2** can be used with #4100.6 EV Manual Controller. Also recommended is Smart Charger #4066.1.

### Please Read If Using an EV-Manual Controller

The EV-Manual Controller used with Ikelite DS Substrobes has two user settings. One setting is for strobe selection, the other is for pre-flash or non pre-flash. **Your camera model uses pre-flash** in all shooting modes except "M manual mode. The EV-Controller should be set to the pre-flash position except when using "M" manual mode. We recommend setting the Controller for "pre-flash" and using "Av" aperture priority mode.

13

## Control Maintenance

Ikelite controls are designed to provide years of reliable service with minimal maintenance.

1. Push button controls require no maintenance other than rinsing in fresh water after saltwater use. If a push button control becomes difficult to push, or if it sticks when depressed, soak the housing in luke warm fresh water. After a few minutes operate the push button. If this does not correct the problem, return the housing to Ikelite for routine maintenance.
2. If a housing control shaft becomes "sticky" and hard to operate, return the housing to Ikelite for routine maintenance.

15

## Optional Accessories (cont.)

### Tray with Release Handle #9523.31

Tray and Release Handle is required to mount external Ikelite Digital Substrobes (except AF35) - page 13. Contact an Ikelite dealer to order and receive additional information regarding all Ikelite strobe packages.



### Ikelite W-20 Wide-Angle Conversion Lens #6420

An external wide angle conversion lens increases angle of coverage, so you can get closer to your subject while still fitting everything in the frame. Add an Ikelite W-20 or other 67mm wide-angle conversion lens to improve your angle of coverage in any shooting situation.

Vignetting will occur at widest angle camera lens setting with these lenses. Zoom in 2 or 3 times to eliminate, or crop the image in post-processing.

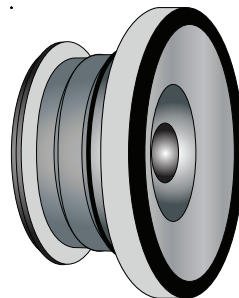

**NOTE:** Accessory 67mm macro lenses designed for underwater use may also be attached directly to the front of the housing's port. Bayonet mount lenses cannot be used with this housing.

Complete information regarding strobe packages and optional accessories is available at [www.ikelite.com](http://www.ikelite.com)

14

## Maintenance

The Ikelite Digital Housing should be given the same care and attention as your other photographic equipment. In addition to normal maintenance, we recommend that the housing be returned to Ikelite periodically to be checked and pressure tested.

1. **Do Not** leave the camera and housing in direct sunlight for prolonged periods. Heat may damage the camera.
2. **Do Not** ship the camera in the housing.
3. Keep the back o-ring clean and lightly lubricated. Only apply enough lubricant to make the o-ring feel slick. **Do Not stretch the o-ring.** This light coating of lubricant will help to keep the o-ring from drying out, and will also reduce friction when opening and closing the housing. Keep the area where the o-ring fits and the sealing surface of the housing clean.
4. Rinse the housing exterior thoroughly in fresh water after each salt water use. Dry with a soft cloth. Dry lens port to eliminate water spotting.

After several uses in salt water, soak the housing exterior in a mild soap solution, then rinse and dry before storage. When storing the housing, remove the back o-ring, lightly lubricate, and place in a plastic bag. Place the plastic bag with o-ring inside the housing for safe keeping.

16

## General Tips

1. Due to the power required to operate the camera, flash, and LCD screen, it is a good idea to start each dive with a fresh set of batteries.
2. Some cameras reset their flash to AUTO when the camera is turned on. If you prefer another setting be sure to select it.
3. As soon as you enter the water, take a moment and check the housing to see that it is properly sealed.
4. Next, check to see if there are any bubbles on the face of the lens port. If there are, take your finger and remove them. If there are bubbles on the lens port they can produce soft focus spots in your photographs.
5. If you are shooting with the camera's built-in flash and the camera's lens is set to the widest angle, you may need to zoom the lens slightly or a shadow may appear in the lower left corner of close-up photographs. The lens port may block some of the light. Installing the flash diffuser will help to eliminate the shadow. *(You can test this above water)*  
To shoot photographs closer than 2 feet (0.6m), you need to use an external strobe such as the AF35, DS51, DS125, or DS160. With an external strobe you can position it so nothing blocks the light path between the strobe and the subject.

17

## Photo Tips (cont.)

4. Do not shoot down on subjects as they will quite often blend into the background and be difficult to see in the photograph. Shoot subjects straight on or shoot up at a slight angle using the blue water as a contrasting background.
5. Underwater flash is used to restore the warmer colors filtered out by the water as well as to illuminate the subject. When photographing underwater, set the camera to use flash on every shot. If the camera's flash is set to AUTO and the sun is behind your subject, the camera may see enough light that it does not fire the flash. With the sun behind the subject, the subject is shaded (dark) and needs flash for a good exposure.
6. If over-exposure occurs, enable macro setting. If over-exposure continues, zoom in and back away from the subject.
7. If your camera consistently over or underexposes the image when using daylight or flash, you may want to adjust your camera's exposure compensation settings (if offered on your model). Many cameras allow you to adjust both available light and flash exposure with an EV "Exposure Compensation" control in the camera's menu.
8. Many photographers transfer their images to the computer where they can fine tune the appearance of the image. Many of the image manipulation programs make you think you can magically correct any image taken and make a good picture. Note that if the image is overexposed, much of the color is missing. If the color is missing you cannot adjust it. If images are slightly underexposed, the color is there, and you can adjust exposure to some degree. So, if you error in exposure, it is better to have the image slightly underexposed rather than over exposed.

19

## General Tips (cont.)

6. **NOTE:** Fogging of the port glass may occur due to a variety of environmental factors. To prevent fogging issues, always assemble the housing in a cool, dry area, and keep the housing out of direct sunlight. If fogging persists, insert a fresh dessicant packet inside the housing before each day of diving (dessicant packages are not available from Ikelite, however most camera stores carry them).
7. Before placing your camera in the housing, it is a good idea to immerse the closed housing in a bucket or rinse tank to make sure it is watertight.

## Photo Tips

1. The number one rule in underwater photography is to eliminate as much water between the camera and subject as possible. Get as close as you can to the subject, then use the zoom if necessary. If you are using flash, subjects beyond 6 feet (1.8m) will not have much color regardless of strobe power.
2. The camera's built-in flash is very close to the camera lens. The flash can light up any suspended particles in the water and they can be recorded in your picture. This effect is called backscatter. To eliminate as much backscatter as possible, photograph close, photograph in clear water, and do not stir up the sand or silty bottom. If backscatter becomes a problem in the environment you are photographing, an external flash will help eliminate much of the backscatter.
3. Digital cameras have a slight lag time between when you press the shutter release button and the camera actually takes the picture. Hold the camera steady a second or two after pressing the shutter release button.

18

## Ikelite Limited Warranty

All Ikelite products are warranted against any manufacturing defects for a period of one year from the original date of purchase. Defective products should be returned prepaid to Ikelite. Ikelite will, at its discretion, repair or replace such products, and will return to customer prepaid. All other claims of any nature are not covered. Housing is pressure tested and warranted to 200' (60m) maximum underwater depth. Except as mentioned above, no other warranty expressed or implied, applies to this Ikelite product.

## Returning Products for Service

Ikelite is most interested in performing any service to assure that all products perform as intended. For repair or service, return the product to the address below with your name, address, phone number and a brief description of the problem. Evidence of purchase date must be provided to obtain warranty service. Normal service turnaround time is approximately 2-3 weeks.



Ikelite Underwater Systems  
50 W 33rd Street  
Indianapolis, IN 46208 USA

When returning products send "attn. Repair Dept."

317-923-4523

"general questions" e-mail: [ikelite@ikelite.com](mailto:ikelite@ikelite.com)  
[www.ikelite.com](http://www.ikelite.com)

#6242.95\_Canon\_S95-01-0810