

Panasonic
ideas for life

P2HD

TENTATIVE



P2HD × AG-HPX500
PRACTICAL GUIDEBOOK

P2HD × AG-HPX500 PRACTICAL GUIDEBOOK

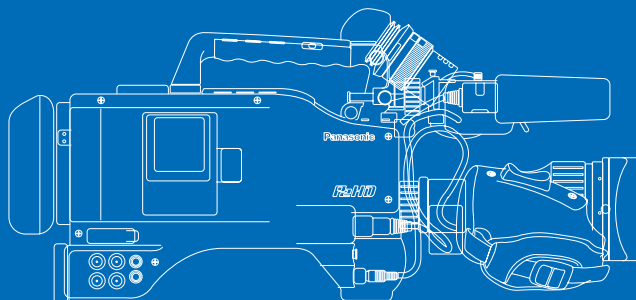

Next-generation camcorder media aimed at professionals, including hard disk drives (HDD) and Blu-ray discs (BD) vary in shapes and structures. However, their main advantage is probably that the data on the media used for shooting does not need to be digitized, meaning that it is ready for immediate use in non-linear editing (NLE) systems. Whereas HDD and BD both require specialized input devices (docking stations or dedicated drives), the P2 (Professional Plug-in) card system proposed by Matsushita provides the benefits of solid-state memory, including durability, portability and freedom from mechanical issues. This gives it numerous advantages over other media as a recording system for professionals. In recent years, a key issue for all production sites has been ensuring that their recording media works smoothly with their PC systems. In this regard, because they can be used in existing PC card slots and allow data to be transferred directly to notebook PCs with ease, Matsushita's P2 cards offer an extremely convenient and efficient media system in comparison with other non-contact media.

A 16 GB P2 card will hold roughly 16 minutes of broadcast-quality HD format 1080i signals using DVCPROHD mode, or around 40 minutes of 720p mode recording in 24p native mode. Clearly, the key limitation is the short absolute limit on recording time when compared with existing tape-based recording and other formats. But when we consider the prospects for future development and the future of the SD memory cards that provide the basic technology for P2 cards, it is also apparent that these problems are only short-term issues and will soon be overcome.

And while other media provide only one means of access (recording) for each recording (shot), the P2 system provides a Hot Swap function that allows multiple cards to be inserted in parallel for sequential recording. This means that 2 or more P2 cards can be used to record indefinitely without disconnecting the backup line.

Looking at the development roadmap for the future of P2, the capacity is slated to double each year while the cost per unit of capacity will fall. For instance, with the 32 GB P2 card planned for release at the end of 2007, it will be possible to shoot continuously for approximately 2 hours on the new AG-HPX500 introduced here, since that model comes with 4 slots, each of which will store 32 minutes of HD recording. Even on its predecessor the AG-HVX200, it will be possible to record 1 hour of HD video, recording 32 GB in each of its 2 slots. And given that later models will support the new AVC-Intra data compression codec, P2 media clearly have a bright future. With such strong future prospects, the P2 card system will surely become the media of choice for core photography flow systems at professional sites of the future.

This guidebook is intended primarily for AG-HVX200 users or those who are running tape media operations (DVCPRO, DVCAM, etc.) with conventional SD, and provides straightforward descriptions of the procedures and settings for a basic photography, recording and editing system capable of creating and handling HD productions using the AG-HPX500 and the P2 card system.

Contents

P3_4	1	AG-HPX500 Basic Setting for Aquisition
P5_6	2	AG-HPX500 Recording codec and format
P7_8	3	Variable Frame Rate Data capacity according to collection format / AG-HPX500 Pre-shooting setup
P9_10	4	AG-HPX500 Pre-shooting setup
P11_12	5	Hot Swap feature of the P2 system Method of back up various data
P13_14	6	Special Effect Variable Frame Rate
P15_16	7	Special Recording Pre-REC/One-Shot/Loop REC/Interval REC
P17_18	8	Using P2 Cards
P19_20	9	From P2 to non-linear editing workstation
P21_22	10	Editing of Advanced mode (pA) Frame rate converter (Software)
P23_24	11	Method of operating P2Viewer
P25_26	12	P2 data back-up and creating archives
P27_28	13	P2-compatible non-linear editing systems other than Apple Final Cut Pro
P29_30	P2HD	P2HD X AG-HPX500 List of Terms

Shooting Procedure

Operation of the P2 system begins with deciding what to shoot, and how to shoot it (tone, recording format).

59.94Hz (NTSC) and 50Hz (PAL) settings

Before shooting with the AG-HPX500, set it to 59.94Hz (NTSC) or 50Hz (PAL).

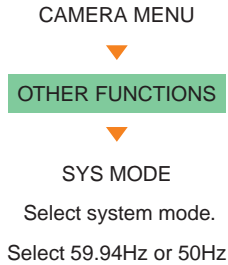

(2) Setting the recording format

Next, under REC FORMAT (recording format), select 1080, 720 or 480(576) setting.

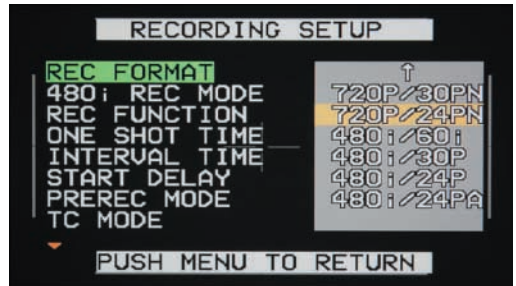
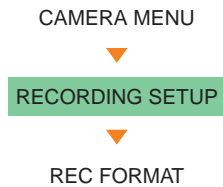

*Selecting 1080 or 720 at this stage will result in HD recording, while selecting 480(576) will result in SD recording (for details, see pp. 5-6)

(3) Recording format = SCENE FILE setting

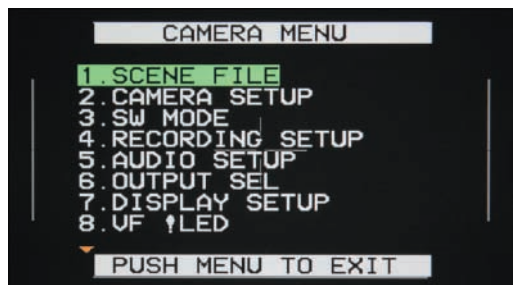
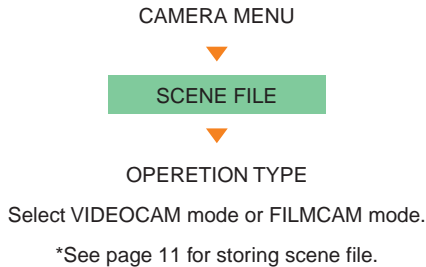

VIDEOCAM mode and FILMCAM mode

AG-HPX500 has VIDEOCAM mode and FILMCAM mode.

Each mode has some exclusive functions against another mode.

<Exclusive features of each mode>
 VIDEOCAM mode: Shutter(1/sec.), Special Recording(Loop REC, Interval REC, One-shot)
 FILMCAM mode: Shutter(Angle), Variable Frame Rate

Recording codec and format

Operation of the P2 system begins with deciding what to shoot, and how to shoot it (tone, recording format).

AG-HPX500 recording codec

Like the AV-HGX200, the AG-HPX500 has a total of 32 recording formats (14 HD formats and 18 SD formats) that can be selected, depending on shooting conditions.

The codec for recording to P2 card is DVCPRO HD when recording in HD format (1080, 720), while when recording in SD format (480/576), DVCPRO 50, DVCPRO, or DV can be selected.

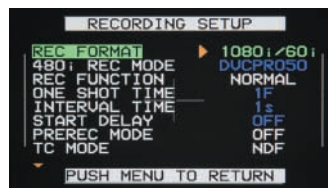

Setting at HD

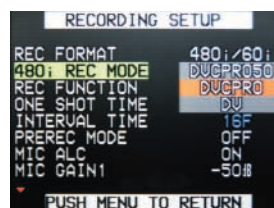

Setting at SD

Image formats and codecs supported by the AG-HPX500

With the P2 system, it is possible to have recordings in a variety of these formats on a single P2 card, but it should be noted that at time of playback, the format must be the same as that used when recording.

Image format*1		Recording time*3	Recording codec
HD 60Hz	1080/60i	64 minutes	DVCPRO HD
	1080/24p(over 60i)		
	1080/24pA(over 60i)		
	1080/30p(over 60i)		
	720/60p		
	720/24p(over 60p)		
	720/30p(over 60p)		
	720/24pN(Native)*2		
720/30pN(Native)*2	128 minutes		
HD 50Hz	1080/50i	64 minutes	
	1080/25p(over 50i)		
	720/50p		
	720/25p(over 50p)		
	720/25pN(Native)*2		
SD 60Hz	480/60i	128 minutes(DVCPRO 50) 256 minutes(DVCPRO/DV)	
	480/24p(over 60i)		
	480/24pA(over 60i)		
	480/30p(over 60i)		
	576/50i		
SD 50Hz	576/25p(over 50i)		

*1: "24p" is recorded as 23.98p, "30p" as 29.97p, and "60p" / "60i" as 59.94p and 59.94i respectively.

*2: Only valid frames will be recorded when in native mode.

*3: Stated recording times are those when four 16GB P2 cards are used. When one card is used, recording time will be 1/4 of that shown. In addition to image format and codec, the function setting and number of cuts may also affect recording time.

Checking the format

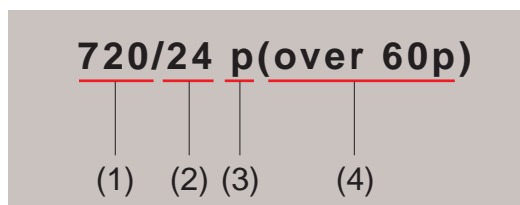

- (1) Size of angle of view (based on number of vertical lines in the image)
 - (2) Frame rate (camera CCD side)
 - (3) p = progressive, i = interlace
 - (4) Frame rate for this recording format during standard recording
- * (4) will only appear when the CCD frame rate differs from the recording frame rate

General HD recording methods

Standard recording

1080/60i, 50i •Suitable for high-definition broadcasting, such as digital terrestrial broadcasting

1080/24p(over 60i) •Movies for theatrical release, etc.
Also known as normal 2:3 pull-down recording.

1080/24pA(over 60i) •Movies for theatrical release, etc.
If it is possible to convert 2:3:3:2 advanced pulldown in editing, accurate 24-frame conversion is possible.
Note) Please check with post-production to confirm whether it is possible to remove advanced pulldown.
[* Please refer to "Importing to 6-1 FCP" for the details of advanced pull-down removal in Final Cut Pro.](#)

1080/30p(over 60i)
1080/25p(over 50i) •Commercials, music videos, CG synthesis, Blu-Ray/HD-DVD content

720/24p(over 60p)
720/30p(over 60p)
720/25p
720/60p
720/50p Commercials, music videos, CG synthesis, video for public urban broadcast, Blu-Ray/HD-DVD content, Web video, mobile-terminal video, etc.

[720/24p(over 60p) might be used for Movies for theatrical release.]

Shutter speed guide

- Shutter speed (default)

60i-60p mode	1/60(OFF), 1/100, 1/120, 1/250, 1/500, 1/1000, 1/2000 second
30p mode	1/30, 1/50(OFF), 1/60, 1/120, 1/250, 1/500, 1/1000 second
24p/24pA mode	1/24, 1/50(OFF), 1/60, 1/120, 1/250, 1/500, 1/1000 second
50i-50p mode	1/50(OFF), 1/60, 1/120, 1/250, 1/500, 1/1000, 1/2000 second
25p mode	1/25, 1/50(OFF), 1/60, 1/120, 1/250, 1/500, 1/1000 second

- Shutter speed (variable)

60i mode	1/60.0 - 1/249.8
30p mode	1/30.0 - 1/249.8
24p-24pA mode	1/24.0 - 1/249.8
50i-50p mode	1/50.0 - 1/249.8
25p mode	1/25.0 - 1/249.8

- Shutter speed (slow)

60i-60p mode	1/15
1/30 30p mode	1/15
24p-24pA mode	1/12
50i-50p mode	1/12
1/25 25p mode	1/12

(4) Gamma Setting (Eight-Mode Gamma)

Drawing on technologies developed for the VariCam, Panasonic has equipped the AG-HPX500 with advanced gamma functions that address eight different shooting scenarios and expand your creative abilities. Included are Cine-Like Gamma, which gives recordings the characteristic warm tone of film recordings, and a News Gamma that's designed especially for news gathering.

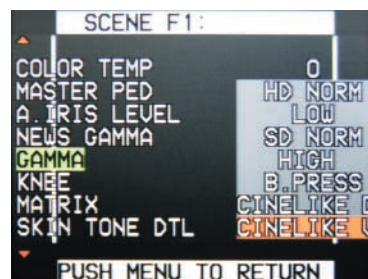

7 Gamma modes are preset in Gamma menu.

AG-HPX500 Gamma Modes

NEWS:	Minimizes washout to faithfully capture all visual information especially in the highlights
HD NORM:	Suitable for HD recording
LOW:	Works to flatten out high-contrast scenes
SD NORM:	Normal setting for SD
HIGH:	Provides additional contrast and color gradation
B.PRESS:	Provides more contrast and richer blacks to low-contrast scenes
CINE-LIKE_D:	Shifts the Cine-Like mode to prioritize dynamic range
CINE-LIKE_V:	Shifts the Cine-Like mode to prioritize contrast

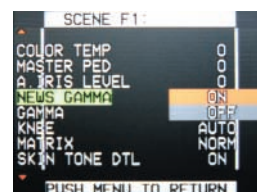

NEWS Gamma is set as independent menu.

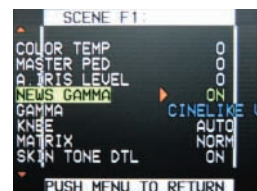

Setting NEWS gamma ON causes not selecting other gamma.

For Cinema shooting, recommend to select CINE-LIKE_D or CINE-LIKE_V, and adjust chroma level etc., so that you can get film-like tone footage as you want. Your original setting can be stored on each scene file dial.



Variable Frame Rate-capable recording modes

About the difference between Native (pN) and "over60p" Mode

When recording in native (pN) mode, it is possible to check data recorded at Variable Frame Rate (VFR), such as slow motion or quick motion, with camera output. Also, only valid frames are recorded, extending the recording time and allowing more data to be stored on the P2 card than is possible in normal mode. (See accompanying table)

Over60 = Varicam-compatible mode; VFR recording is possible, but the difference in pulldown systems makes it impossible to check the VFR with camera output. A frame rate converter such as hardware or NLE should be used.

About standard recording (over60)

As with Varicam, regardless of the camera's frame rate setting, recording will occur at 60 frames per second (over60). For example, when 24p mode is selected, 60 frames will be recorded with 2:3 pulldown. Thus, no matter what frame rate is selected, it is necessary to have the storage capacity for 60 frames, including duplicate frames. The advantages of standard recording are: output from the IEEE 1394 interface to DVCPRO HD is possible during recording, and when recording for extended periods, FS-100 data storage or DVCPRO HD tape storage in the AJ-HD1400, etc., is possible. For undercrank and overcrank shooting, as long as special effects are not required, shooting in native mode (30pN/25pN/24pN) is recommended in order to save space on the P2 card.

*To check variable frame when using 720p, a frame rate converter (hard device such as the AJ-FRC27, or similar software) is necessary.

About native recording

30pN/25pN/24pN are recording formats. The letter "N" indicates Native. In native mode, video data is recorded on the P2 card at the frame rate used by the camera. In this mode, it is possible to record on a P2 card for 2 to 2.5 times as long as in standard (30p/25p/24p) mode. Another major advantage of native mode is that it allows on-the-spot playback of variable frame data without a frame rate converter. After recording, it is possible to output to DVCPRO HD from the IEEE 1394 interface.

*Native recording is the recommended mode for chroma key synthesis.

Usage of native recording

720/24pN	Commercials, music videos, CG synthesis, Blu-Ray/HD-DVD content, Web video, mobile-terminal video (progressive moving image), etc.
720/30pN	
720/25pN	

Variable frame rate functions at the 720P setting when "OPERATION TYPE" is set to FILM CAM.

Data capacity for each recording type (DVCPRO HD)

Standard recording	1G=1 minute
Native recording	1G=2 minutes (using 30pN/25pN)
	1G=2.5 minutes (using 24pN)

Recording time for P2 card using VFR (16GB)

Format *1		Recording codec	Recording time*3 (One card using)	Recording time (Four card using)
HD	720/60p	DVCPRO HD	16 minutes	64 minutes
	720/50p			
	720/24p(over 60p)			
	720/25p(over 60p)		40 minutes	160 minutes
	720/30p(over 60p)			
	720/24pN(Native)*2			
	720/25pN(Native)*2			
720/30pN(Native)*2	32 minutes	128 minutes		

*1 "24p" is recorded as 23.98p, "30p" as 29.97p, and "60p" / "60i" as 59.94p and 59.94i respectively.

*2 Only valid frames will be recorded when in native mode.

*3 When using 8GB P2 cards or mini DV tape, the stated recording times are valid when using two P2 cards, or when using AY-DVM60, respectively. When one 8B card is used, recording time will be 1/2 of that shown.

Pre-shooting setup (1)

(*The contents of this section are intended for users who are not accustomed to working with professional video cameras.)

The camera design of the AG-HPX500 is a chassis design suitable for use by broadcasting professionals, and it may seem difficult to use for those accustomed to using the AG-HVX200. However, once an understanding of the essentials of setup and operation has been gained, shooting becomes easy for any user, including AG-HVX200 users.

Lens setup, battery setup, audio setup, etc.? Setup specifications for the professional-quality video camera

Lens setup

As the lens mount of the AG-HPX500 is a "B4 mount," the type generally found on video cameras for professional or broadcasting use, a wide variety of professional-quality lenses can be used. However, in order to obtain the benefits of the AG-HPX500's unique Chromatic Aberration Compensation (CAC) function and get the best color results, use of one of the maker-endorsed digital HD lenses (shown below) is recommended.

Canon (3 varieties)
KJ10ex4.5B IRSD PS12
KJ16ex7.7B IRSD PS12
KJ21ex7.6B IRSD PS12
Fujinon (2 varieties)
XA17x7.6BERM-M58B
XA17x7.6BRM-M58B



*The above list shows compatible lens varieties as of Feb. 2007. The range of compatible lenses is expected to grow in the future.

*2/3-inch mount-compatible HD cine-lenses such as Carl Zeiss Digiprimes may also be attached.

*Note) It may be possible to use some high-performance SD lenses, but when using lenses other than those endorsed by the maker, please be aware that there is a risk of adverse effects such as vignetting (reduction of the image periphery) or color bleeding.

Things to keep in mind when using a 35mm film lens adapter with the AG-HPX500

*When shooting movies or commercials with a 35mm film camera lens, it is possible to shoot using a lens adapter, but please be sure to use an adapter for a 2/3-inch lens.

(For example, when using a P + S Technik image converter, use a pro35 which is compatible with a B4 mount, rather than a mini35 such as is used with the AG-HVX200.)

*Also, in such a case, depending on the equipment, there is a possibility that the image will be recorded upside down. If this is occurring, one can invert the LCD monitor while shooting, but it is impossible to invert the viewfinder or the HD-SDI output. It is necessary to flip the image using a nonlinear editing system.

Pre-shooting setup (2)

Battery setup

For the AG-HPX500 battery bracket, attachment of an Anton bracket (Gold Mount) for professional-quality batteries is standard. The battery menu also lists items made by other companies, and their compatible V-mount batteries (at the automatic default setting, 12 varieties are listed), so any professional-quality batteries in general use can be used. Also, the camera has full compatibility with info lithium batteries, so if one selects battery from the menu, the battery information (display of quantity remaining, etc.) will be returned via the viewfinder. (Note that the camera is not compatible with the small battery used in the AG-HVX200.)



Audio setup

With the AG-HPX500, a Canon connector (3-pin XLR) can be used for the audio input, and individual sounds can be matched independently, so separate audio strains can be input with 1/2ch. Phantom +48v power supply is also possible, so efficient mikes such as gun mikes can be directly connected. (*No slot-in wireless function)



Setup for shooting: Gain / Iris / WB

Lens, iris and image quality adjustment

The lens may be one of the most difficult parts of the camera to understand, but when compared with the AG-HVX200, the lack of auto-focus is the only substantial difference. Otherwise, it can be used in much the same way. The focus must be adjusted manually, but setting the focus in advance makes this easy. First, zoom in the object you want to shoot, rotate the focus ring adjust it, and then adjust zoom as you want..

Iris adjustment may be done automatically, but there is also an easy way to do it manually. Turn on the zebra pattern inside the VF (viewfinder), and then adjust the iris ring so that the zebra pattern does not appear on the object you wish to shoot (for example, on the skin of a person you are shooting.) The zebra pattern setting (within Camera Setup) should be 100% (or 95%). The VF and LCD monitor of the AG-HPX500 do not respond to HD signals, so when capturing on a site where you require a more severe focus, use an SD connection to an external monitor such as the optional 7.9 inch/multi-format monitor in order to confirm that the image has HD picture quality.

Setting the WB (White Balance)

- (1) Set the WHITE BAL switch to A or B. Separate settings are created for the A and B channels (e.g.: Cloudy/Fine, Outdoor/Indoor).
- (2) Place a grayscale chart (see right) or a white piece of paper in the same location as the setting for your shot and zoom in so that it completely fills the screen.
- (3) Adjust the lens aperture. Use the normal Auto Iris function to set the aperture.
- (4) Push the AWB switch upwards to set the white balance.
- (5) Push the AWB switch downwards to set the black balance (BB).
- (6) Push the switch up again to set the white balance more precisely.

WB adjustment technique

When setting the WB, one can experiment with disrupting the color temperature and giving the image a warmer feel by selecting warmer color. Some high-grade inkjet papers have a small amount of blue mixed in, in order to bring out the white more, and it can be interesting to line up a few different types of "white" paper and observe the differences in hue. (Another trick is to cover the lens with a white.)



Flange Back = Back Focus = Rear Focus

Because cameras such as the AG-HPX500 that use B4 mounts are designed to allow easy lens removal, the distance from the mount to the light-incident surface of the CCD (the "flange-back" distance) sometimes differs slightly depending on the camera (or lens) used. So if you change the lens-camera combination, the back focus will need to be adjusted. If the back focus is incorrect, images will not be correctly focused for either macro shots or telephoto shots. Adjust the flange back (F/B) distance using a chart such as the one attached.

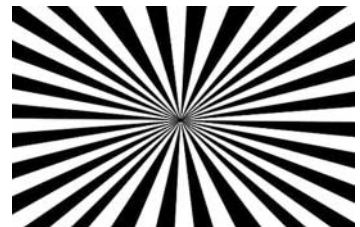

Gain

Adjust the gain when shooting at outdoor locations, or other places where the brightness is outside the standard range. The toggle switch on the side of the camera has three sensitivity settings assigned standards of 0db / +6db / +12db, but it is possible to change each number individually, shifting according to the lens one is using.

The ?12db setting gives a grainy image, and is rarely used. When possible, it is best to assign a value of +9dB instead.



Selecting a tripod

It is assumed that the AG-HPX500 will rarely be swung around freely in the manner of the AG-HVX200, and even when shooting the same scene, the AG-HPX500 has different requirements. It may be necessary to set Gamma, to adjust the black level to boost reproduction of dark areas, and during extremely slow zoom-in/zoom-out, or for simple fixes, especially with interval shooting (see p. 15), a tripod allowing firm positioning and very smooth movement is a necessity. Compared with the AG-HVX200, it is a larger camera both in terms of chassis and in terms of mass, and a suitable tripod must be selected or it will be unstable.

Stable picture quality can be obtained by selecting a tripod by a well-known maker, such as the Sachtler System 18, the Vinten Vision 11, or a comparable tripod.



Hot Swap feature of the P2 system / When using 2 or more P2 cards

When recording on location, the Hot Swap feature is the greatest blessing of a P2 card system camera. With tapes, other types of hard disks or Blu-Ray disks, replacing the media while the camera is operating or recording, and continuing to capture, is of course impossible. With the P2 system, however, if one has at least 2 cards and a PC, or a P2 data storage device such as P2 Store or P2 Gear, etc., it is possible to capture continually for a longer period of time than the capacity of a single P2 card would allow.

The AG-HPX500 has four P2 card slots, thus it is possible to record for such extended periods of time as the capacity of 4 cards allows (if using 16GB cards, up to 64GB.)

Note) About recording order of slots

When P2 cards are inserted in all 4 slots at once, data will generally be stored on the cards in ascending order (1 -> 2 -> 3 -> 4). However, phenomena in which the data is not stored in this order may occur? for example, if one switches from standard recording to native recording (24pN, 25pN, 30pN).

Even though the TC (time code) is recorded at an absolute address, thus when the data is loaded into a nonlinear editing system, etc., data files will line up in the order in which they were shot, so there is no risk of trouble.



Saving Scene Files and User Files

With the AG-HPX500, six presets are provided as Scene files and the camera features a dedicated Scene File dial that lets you instantly recall the preset that best fits the shooting conditions. You can save and load up to 8 files on an SD card, with each file containing a Scene file with accompanying settings.

(*Compared with a maximum of 4 files saved/loaded on the AG-HVX200.)

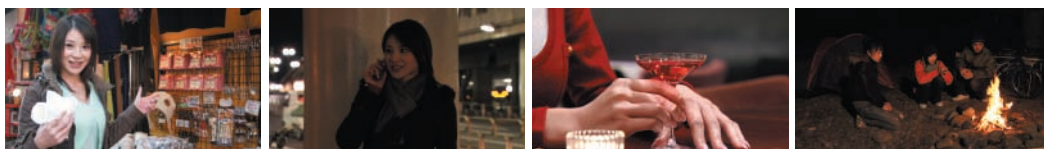

Copying To and Loading From SD Cards

CARD FUNCTION



Select SCENE FILE YES and confirm. (Press the OK (Still /Pause) button.)



Use the  or  button to select the file number to be saved.



Select WRITE and confirm. (*To load a file from the SD card, select READ.)
(* In this procedure you can also type in a file name.)



Use the  button to display YES and confirm.



Press the MENU button 4 times to exit menu mode.



Backup recording of data output from the IEEE 1394 interface

Footage recorded on the AG-HPX500 can be recorded and backup copies made on an external device such as an HDD connected to the IEEE 1394 interface.



Specialized P2 hard disk unit:
FOCUS FS-100



External hard disk

Connecting to an external tape deck (AJ-HD1400)

(When storing data on a DVCPRO HD tape, etc.)

Note) One-shot REC, loop REC, interval REC data cannot be backed up using the IEEE 1394 interface.



Control settings for connected backup devices

OTHER FUNCTIONS

1394 CONTROL (Equipped with 4 modes)

- ▶ **OFF:** Quit control of connected backup device
- EXT:** Control connected backup device using the camera START/STOP button. Recording operations cannot be carried out within the camera itself when in this mode.
- BOTH:** Record simultaneously onto both the camera and the connected backup device.
- CHAIN:** Connected backup device begins to record automatically when recording capacity of the P2 cards fall to a low point during recording.

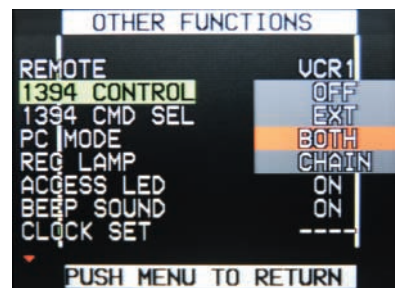
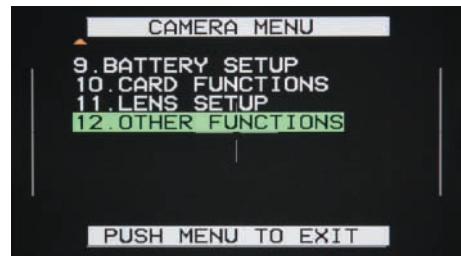

Setting the connected backup device to quit operation when the camera's START/STOP button is pushed

OTHER FUNCTIONS

1394 CMD SEL

- ▶ **REC_P:** Pauses during recording
- STOP:** Stops recording

Note) When the connected backup device is not equipped with a Record Pause function, choose STOP.

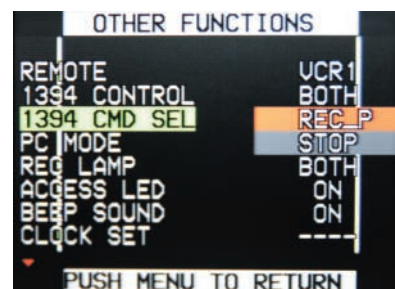

Variable Frame Rate - Overcrank/Undercrank shooting

Variable Frame Rate (VFR) shooting is the most distinctive feature of AG-HPX500. You need to select 720p mode and follow the next page procedures. The basic operation procedures are the same as AG-HVX200.

Overcrank shooting

This is a type of slow-motion effect, known as High Speed (HS). In Progressive mode, when the recording format is set to 24 fps (24p, 24pN), 25 fps (25p, 25pN) or 30 fps (30p, 30pN), you can shoot slow-motion video by setting a higher than original frame rate, up to a maximum of 2.5 times the original rate (60 fps set in 24p mode).

Undercrank shooting

This is the opposite of the overcrank concept. By setting a lower frame rate than that of the selected format (less than 24, 25 or 30), you can shoot fast-motion video that looks speeded up when you play it back.



Procedure for using VFR (required settings)



1. Set the camera mode to FILMCAM.

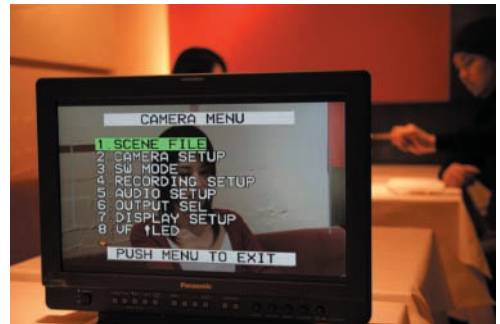
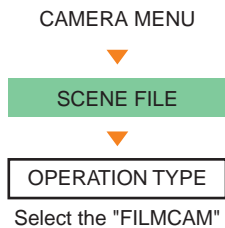

2. Set the recording mode to 720p. (VFR effect can only be seen instantly in Native mode.)

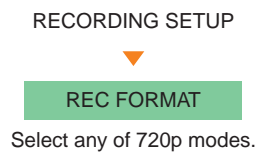

3. Set the frame rate to one of rates between 12 and 60(50).

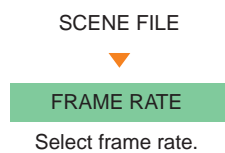

(Frame rates between 12 and 60(50) can be set.)



With these 3 steps, you are ready to shoot in VFR mode. Note also that during Progressive shooting in modes other than Native mode, the camera records in the over60p format, so that on-site (camera output) slow- or quick-motion video checking or monitor checking is not possible.

Special Recording

AG-HPX500 has some other special recording modes.

Special recording requirements: Recording is possible in the conditions below.

(1)OPERATION TYPE	VIDEO CAM mode
(2)Recording formats	1080/60i, 1080/50i, 1080/30p, 1080/25p, 720/60p, 720/50p 720/30p, 720/25p, 576/50i, 576/25p, 480/60i, 480/30p

Pre-REC

This allows you to record video and audio for a set period prior to the record button actually being pressed (approx. 3 seconds for HD recording and approx. 7 seconds for SD recording).



Note) Pre-REC does not work in the following shooting modes:

- When recording through IEEE 1394 input
- Starting to record during playback
- During interval recording
- During One-shot recording
- During Loop recording

One-shot recording

This mode records certain frames by setting. This mode is like a still camera mode.



Note) Files recorded during One-shot recording are collected together into a single file.

Loop Recording

If you are inserting 2 or more P2 cards into the slots, this mode lets you record indefinitely by successively switching cards until you are ready to stop. This is especially effective for shooting fixed-point observations.



*1) To pause Loop recording, you can stop recording using the Start/Stop trigger, but to release the Loop recording you need to select **NORMAL** in the REC FUNCTION settings.

*2) Use at least two P2 cards each has 1 minute or more of remaining recording time.

*3) Recording stops when either P2 card is removed.

Interval Recording

Interval Recording records a single frame at set intervals.

This feature can be used for applications such as recording shots of a set location over long periods of time.

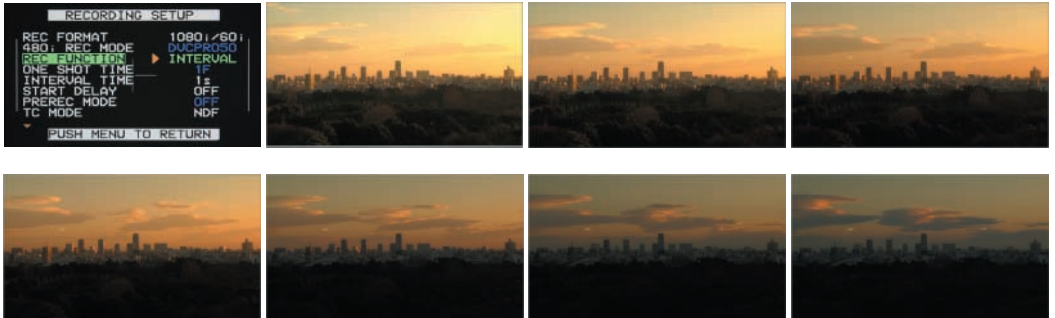

*1) Audio is not recorded.

*2) Files recorded using Interval recording are collected together into a single file.

Note) All the above Special recording modes are started by pressing the camera's Start/Stop trigger, but Interval and One-shot recording are stopped by pressing the STOP button  on the camera deck.

Settings for special recording modes

1. Select "VIDEOCAM" in the menu of scene file.
2. Select one of the following recording formats.

CAMERA MENU



SCENE FILE



OPERATION TYPE

Select "VIDEOCAM"

1080/60i, 1080/50i, 1080/30p, 1080/25p,
720/60p, 720/50p, 720/30p, 720/25p,
576/50i, 576/25p, 480/60i, 480/30p

- Pre-REC

3. RECORDING SETUP

PREREC MODE

Set PREREC MODE "ON"

- Interval REC/Loop REC/One-shot

3. Select Interval, Loop or One-shot recording

RECORDING SETUP



REC FUNCTION

▶ INTERVAL REC
LOOP
ONE SHOT

4. Select a setting for the Interval "time" or One-shot "time"

RECORDING SETUP

ONESHOT TIME

1F, 2F, 4F, 8F, 16F, 1s

INTERVAL TIME

2F, 4F, 8F, 16F, 1s, 2s, 5s, 10s, 30s, 1m, 5m, 10m

Note) When you are using Interval, Loop or One-shot recording, you cannot make backup recordings through the IEEE1394.

Using P2 Cards

Recorded images can be checked on the AG-HPX500's LCD monitor as thumbnails of each file.



Basic thumbnail operations

Select MCR mode
by pressing mode button.

▼
Press MENU button to display thumbnail menu.
(MENU buttons are located under inside of
LCD and front side of the camera.)

▼
Use the ◀▶ or ▶▶ button to select a thumbnail.
(The yellow frame indicates the selected thumbnail.)



Playing back selected file

Select the thumbnail you want to play and press the ▶▶ button.

Note) You need to set the same recording format as the clip you want to play.

Select Slot

Follow the procedure below to select which of the four P2 card slots on the AG-HPX500 will be used for playback.

Press the MENU button
on the thumbnail screen.

▼
In the menu, press the ◻ or ▶▶ button to select
THUMBNAIL and then press the ◻▶▶ button.

▼
Then, from the same menu, press the ◻ or ▶▶ button to select
SHOT CLIPS and select the slot you want to use.



Deleting Clips and Formatting P2 or SD Card

This section describes how to delete individual clips and how to format a P2 card or SD card.

* Recommend to format a P2 card on a P2 camera or other P2 device.

To delete clips:

Select the clip you want to delete in the thumbnail screen and press the MENU button.



In the menu, press the or button to select OPERATION and then press the or button.



Select DELETE and press the button.

To format a P2 or SD card:

Insert the P2 card or SD card you want to format.



In the menu displayed in the thumbnail screen, press the or button to select OPERATION and then press the or button.



Select FORMAT, select the or the in the card selection screen and then press the button.



Select whether or not to proceed with formatting.

TOPIC!

Data stored on P2 cards

When you store images on a P2 card, an hierarchical structure such as that shown in the figure right is created on the card. (This is of Final Cut Pro.)

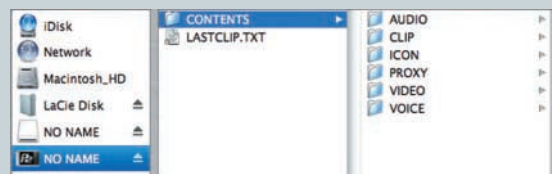

"Data stored on a P2 card" refers to the entire data structure on the card including the CONTENTS folder. When you copy or back up P2 card data, you must copy all the data on the card.

Note) You need to copy not only the CONTENTS folder, but all the data.

Note) If you back up just the MXF files in the VIDEO folder, you will not be able to play the video.

* For more information on the backup procedure, see P.25-26, "Making Backups and Archives".

From P2 to non-linear editing workstation

Ingesting procedures using Apple's Final Cut Pro

In this section, Apple's non-linear editing system Final Cut Pro is featured to show you examples of editing data from P2 card(s).



Mounting P2 card onto the computer's operating system via AG-HPX500

1. From the SETUP menu, select

OTHER FUNCTIONS

PC MODE followed by 1394 DEVICE

2. Press the camera's MENU button twice, to exit from the menu mode.

3. Press the function mode button to turn the MCR lamp on. Press and hold the button (for more than 2 seconds) to enter the PC mode.

DEVICE CONNECT is displayed; P2 card is mounted, with its icon appearing on the desktop.

Note: To exit PC mode, unmount (eject) the P2 card on the Desktop, and turn the camcorder off.

* If the P2 card icon does not appear on the Desktop

Application

Utilities

Disk Utility (as shown in the screenshot).

In the left column, select the P2 card marked with gray, then click Mount.

Note: In order to mount the PC card using the PowerBook's PC card slot, you will need to install the P2 card driver.

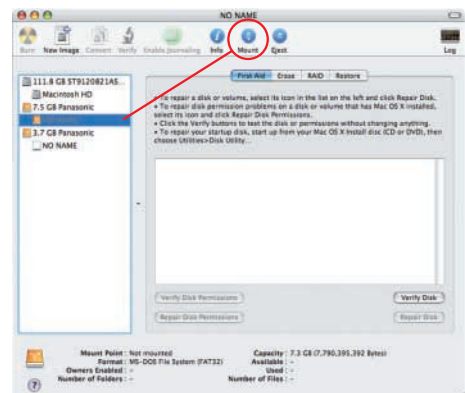

Using Final Cut Pro to capture P2 data

The P2 card data must be converted to Quicktime before being edited on Final Cut Pro. Therefore, you will need to configure "Scratch Disks" under "System Settings" prior to capturing data, as with any other data capturing. Captured P2 data will be stored as a Quicktime file in the Capture Scratch folder specified under "Scratch Disks".

From the pulldown menu, select:

File -> Import -> Panasonic P2.

As seen in the example right, list of data on the P2 card is automatically displayed in the browse section.

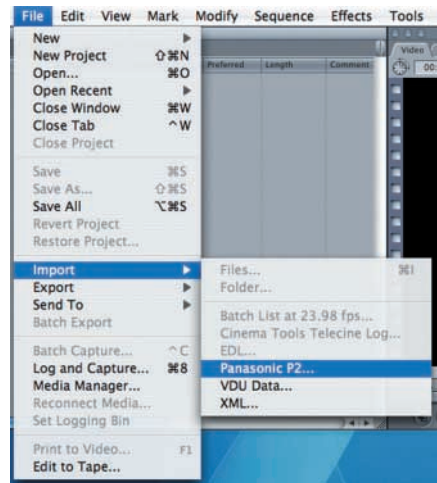

Select a data in the browse section to preview. As in the same manner as handling a magnetic tape medium, you can specify in/out time for capturing.

To capture the clip being previewed, press the "Add clip to the queue" button.

To capture one or more items from the browse section, select item(s), then press "Add selected to the queue"

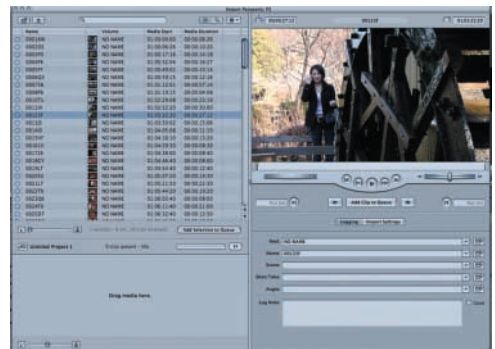

To capture all clips in the P2 card

Click "List View" to switch the hierarchical display. Select the P2 card, and drag it to the queue. This way, all clips in the card or folder are captured.

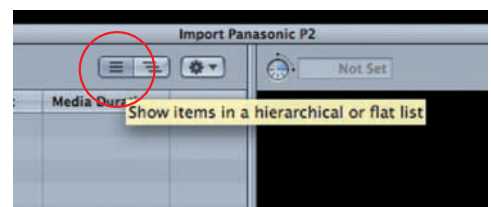

* When capturing of the P2 card is completed, unmount the P2 card from the Desktop, then disconnect the camcorder.

Configuring Removing Advanced Pulldown / Duplicate frames

Removing Advanced Pulldown

Removing duplicate frames in standard-recorded data

To capture P2 data recorded using advanced mode such as 24pA into Final Cut Pro, you must first remove advanced pulldown (2:3:3:2 pulldown) to delete unnecessary frame fields, so that 24 fps (23.98, to be more precise) progressive video can be handled correctly.

Click the button shown on the screen capture image below "Importing from Panasonic P2", and select "Settings...".

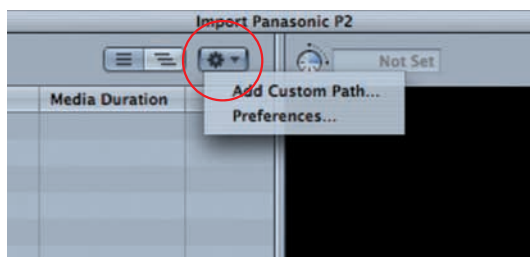

"Import settings" window appears, as shown below; select the checkbox.

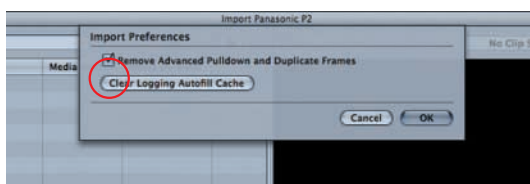

Importing P2 data backed up on a hard drive

Click "Add folder" in the importing window, to select the folder on the drive containing data.

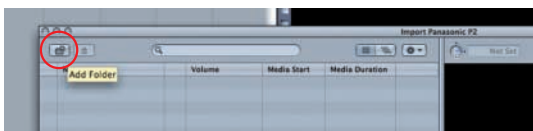

Note: You cannot import data into FCP by directly selecting an MXF file in CONTENTS.

(* Refer to "P25-26 Data back-up and other recording method" for detailed explanation of how to back up data.)



Installation of frame rate converter

If variable frame rate (over 60p/50p mode) is used

If overcrank/undercrank shooting was done using variable frame rate and over60p mode, you will not be able to execute slow/quick playback without using a frame rate converter.

Therefore, you will need to install the frame rate converter plug-in for Final Cut Pro. The frame rate converter plug-in is included in the Final Cut Pro 5.1 (or Final Cut Studio) installation disk.



* In the case of native mode recording (24pN, 25pN, and 30pN), you can directly edit the captured data.

Examples of exporting data from FCP

- Writing AJ-HD1400 via IEEE1394 connection
- Writing to a professional HD deck, via PCI card video interface (such as Decklink by Blackmagic, or Cona by AJA) capable of HD-SDI output
- Tapeless, lossless direct data conversion using Apple Compressor (for webcasting format such as H.264, MPEG2 for DVD, and various other data conversion)

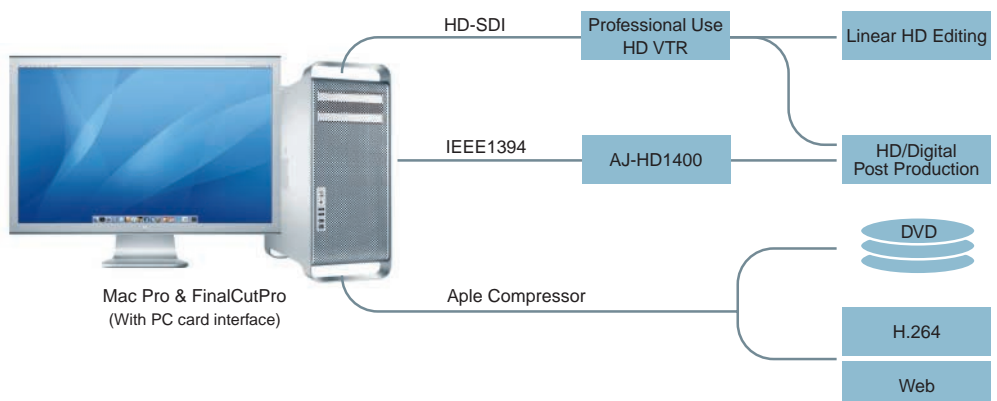

* For webcasting, progressive mode shooting is recommended.

Creating archives using P2Viewer

P2Viewer is a software program to manage data exclusively for P2 card and other P2 compatible equipment. You can use this software to copy multiple cards into one folder, or copy selected clips.



Where to obtain P2Viewer

<https://www.pavc.panasonic.co.jp/pro-av/> (in English)



P2Viewer screen

The composition of the main window greatly divides into four areas.

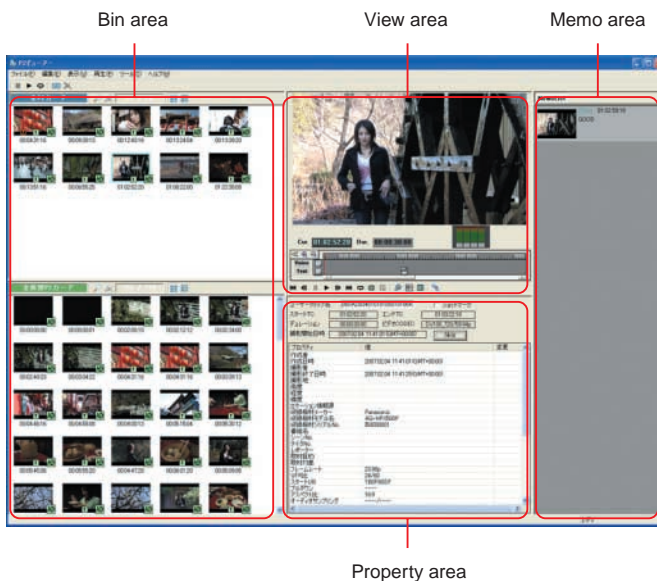

Archiving of P2 cards

In the pulldown menu, select "Show"
-> "Show Primary Bin"
-> "All P2 cards",
to show all clips in the P2 cards
currently inserted.



Next, select the storing destination.

In the pulldown menu, select "Tool"
-> "Configuring Virtual P2 card ...".



In the "Virtual P2 card configuration" window, click the registration button to newly create a folder on the hard drive where the data is stored.

On the screen capture image below, "D:\testP2" is the newly created folder.

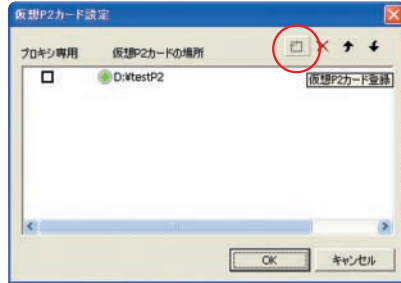

Note: The folder indeed is the Virtual P2 card.

Next,

select "Show"
-> "Show Secondary Bin"
-> "New folder" in the pulldown menu.
Bin area display is divided horizontally.

On the screen capture image below, "D:\testP2" is the newly created folder



From the Primary Bin displayed on the upper section, select the clip you wish to copy, and drag-drop onto the Secondary Bin on the lower section.

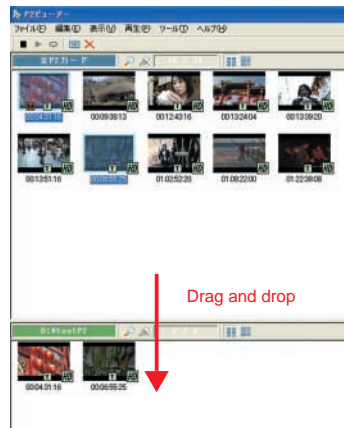

* You can use P2Viewer to take numerous P2 cards, and copy all data into one single folder.
* Prior to copying, make sure that you have enough hard drive space.

P2 data back-up and creating archives

Backing up data onto a HDD (1394 HOST mode)

<Procedures>

1. Connect the HDD to the AG-HPX500 with an IEEE1394 cable and then turn on the HDD.

2. In the Setup menu:

From **OTHER FUNCTIONS**,
select **PC MODE** -> Select **1394HOST** and press **II** .

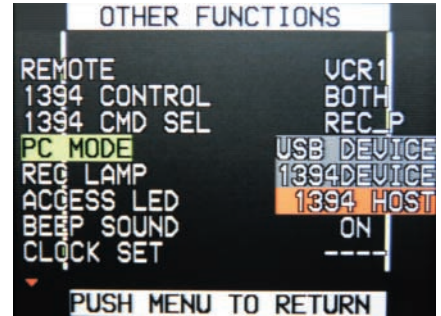

3. Press the MENU button twice to exit menu mode.

4. Use the operation mode button to turn on the MCR lamp and then hold the button down for at least 2 seconds.

-> The PC lamp lights and the camera switches to PC mode.

5. If the HDD has not been formatted,

use the **▶** or **■** button to select **FORMAT (HDD)** and press the **II** button.

-> HDD formatting begins.

6. When formatting ends, use the **▶** or **■** button to select **COPY TO HDD**

and press the **II** button.

7. Use the **▶** or **■** button to select one of the card slots (1 to 4) and press **II**.

A slot selection confirmation message (displaying YES or NO) then appears.



To proceed with copying the files, select YES and press the **II** button. -> Copying begins.

8. When copying ends, turn the camera off.

* Notes on copying files

- Ensure that there is ample free space on the HDD for the copied files.
- Format the HDD for use with the AG-HPX500 beforehand. (Formatting erases all the data on the HDD.)
- Do not make multiple connections (daisy-chain or hub) to the HDD, even while it is turned off.
- You can copy up to 15 P2 cards onto a single hard disk.

Backing up from AG-HPX500 to a HDD

After step 4 in the above procedure, you can check the contents of the HDD by using the  or  button to select PROPERTY and pressing .

You can view the details of items on the hard disk by selecting an item using  or  and then pressing .

* You are allowed to copy up to 15 cards onto one hard disk.

Backing up data onto a HDD using an OS

- You will copy the entire content of the P2 card into a newly created folder on the hard drive. During the procedure, do not change the folder name "CONTENTS". If you wish to back up more than two P2 cards, you must create a named folder for each, then copy data as described above.

- When naming each folder, use number scheme such as 001, 002, ... to help clarify the order of recording.

Note 1: Do not copy the CONTENTS folder only; copy the folder containing CONTENTS and other files in the same directory.

Note 2: You won't be able to play back data by copying only the MXF files in the VIDEO folder.

* To import a folder backed up on the HDD using Apple Final Cut Pro, select the folder on the HDD from within the P2 importing screen using "Add Folder". You cannot import video by selecting the MXF files in CONTENTS.

Refer to "Importing P2 data backed up on HDD" for detailed instruction.

Creating archives using FCP

From the pulldown menu, select:

File -> Import -> Panasonic P2.

From within the Panasonic P2 import screen, press the hierarchy

list display button (A). Select the P2 volume to copy, and click the

pulldown menu (B) to select "Create an archive folder...".

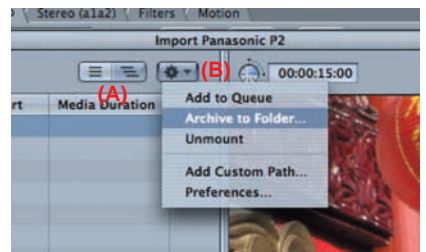

* You can also select the P2 volume, press the control key (right-clicking of the mouse) and click to select "Create an archive folder..." from the shortcut menu.

Combining P2HD data and HDV data

TOPIC!

You cannot combine data shot using a P2HD in a camera such as the AG-HPX500 and HDV data shot using an HDV camera on the same timeline in a non-linear editing system. P2 system HD data is recorded using the DVCPRO HD codec while HDV data is recorded using the MPEG-2@TS codec. As such, the data types are completely different and combined editing on the same system is virtually impossible. To edit HDV data and P2 data together, you need to convert the data to a uniform codec by, for example, converting the HDV data to the DVCPRO HD codec.

P2-compatible non-linear editing systems other than Apple Final Cut Pro

or the latest compatibility information for Windows-based non-linear editing systems and P2-based equipment, visit the following URL:

https://eww.pavc.panasonic.co.jp/pro-av/sales_o/p2comp/index.html

* For compatibility with Windows Vista and related information regarding the latest updates and patches for each software, visit the manufacturer's web site, or contact the manufacturer/vendor directly.

Canopus EDIUS Pro Version 4 and REXCEED series <http://www.canopus.com>



Avid Xpress Pro / Avid Media Composer <http://www.avid.com>



Media Composer set

Appendix: Information regarding composition and post-processing of images

The following data/information are required following the non-linear editing work to move on to work with compositing software or go into post-production. While working with compositing or editing of extracted still images, share the following information with your operators and designers to work on compositing processes more efficiently.

1080 size	Data size	280 x 1080 pixels
	Pixel ratio	1.5
	Interlace	odd number fields are prioritized

When displaying images on Adobe Photoshop, set the horizontal/vertical pixel ratio to 1.5 for accuracy.

* If you are preparing still images for printing, correct the resolution to 1920 x 1080.

The pixels will need to be set back to "square".

720 size	Data size	960 x 720 pixel
	Pixel ratio	1.33

* If you are preparing still images for printing, correct the resolution to 1280 x 720.

The pixels will need to be set back to "square".

PAL mode (50p/25p) 1080 size	Data size	1440 x 1080 pixels
	Pixel ratio	1.33
	Interlace	odd number fields are prioritized

* If you are preparing still images for printing, correct the resolution to 1920 x 1080. The pixels will need to be set back to "square".



P2HD EQUIPMENTS

The latest P2 equipment

P2 card



8GB AJ-P2C008H



16GB AJ-P2C016RG



32GB AJ-P2C032RG



AG-HPX50



AG-HVX200



P2 store
AJ-PCS060G



P2 drive
AJ-PCD20



P2 mobile
AJ-HPM100



P2 Gear
AJ-HPG10

Bayonet Mount

This is a mounting format for lenses that makes them easy to attach and remove. The name derives from the socket-type fastening mechanism used for mounting bayonets on rifles. The movement used to mount the lens on the camera works similarly, hence the name. There are three or four pins on the lens mounting portion and matching slots on the body mounting portion. To mount the lens, you slide the pins into the slots and then turn the lens to lock it. Most lenses for commercial video cameras and still cameras use bayonet mounts. Exceptions include wide conversion lenses and the like that employ threaded screw-on mounts.

BNC

BNC stands for "bayonet Neill-Concelman" and is a type of connector for coaxial cables. On the AG-HPX500, BNC connectors are used for the HD-SDI, VIDEO OUT, T/C, and GENLOCK outputs. These connectors have comparatively good frequency characteristics and can be made quite compact, so they are used widely for a variety of communication applications in addition to video signals. The connecting portion has no threading. Instead, it uses a bayonet mechanism that locks when the connector is inserted and turned. BNC connectors are compatible with coaxial cables ranging from 1.5D to 5D, among which 5D and 3D cables are widely used in commercial applications.

CAC (Chromatic Aberration Compensation)

The CAC function built into the body of the camera-recorder unit corrects registration error caused primarily by minute chromatic aberration that cannot be corrected by the lens itself. This helps minimize rainbow color effects around the periphery of the image.

Clip Thumbnail

Clip thumbnails are miniature stills from video clips recorded on a P2 card that are displayed in a list format. On the AG-HPX500 a list of clip thumbnails is displayed when you switch from REC mode to MCR mode (the equivalent of VCR mode in a camcorder using videocassette tape). One thumbnail is displayed for each clip in the order captured, from top left to lower right. It is also possible to display clip thumbnails in P2Viewer and some nonlinear editing programs. *1 (The clip thumbnail list cannot be displayed on an external monitor connected to the camera.)

DSP

DSP stands for "digital signal processor," a type of specialized microprocessor for manipulating digital signals. The AG-HPX500 is equipped with a high-performance DSP that performs 14-bit A/D conversion and 19-bit "inner processing". It also adjusts the gamma and other settings for the R, G, and B segments of 1080/60p (50p) video signals, as well as performing batch conversion (P/I conversion, line conversion, down conversion) between HD and SD formats. It is due to this advanced DSP that the AG-HPX500 can produce high-picture-quality output in any supported video format.

Frame Rate Converter

This converts recording or playback frame rates for only the valid frames in data stored using the Over60p mode variable frame rate. It plays the frames using the slow- or quick-motion effect that was intended when the frames were shot. In addition to the AJ-FRC27 hardware used in products such as the VariCam, some companies also offer plug-in software for non-linear systems.

The AG-HPX500 and AG-HVX200 allow native-mode recording that is only possible by recording onto P2 cards, so that slow- and quick-motion playback on the camera is possible without an FRC.

Gold Mount/V Mount

These are mounting formats used to mount the commercial camera battery on the camera body. They are types of battery mounts. Gold Mount is the type used by batteries from Anton/Bauer and is included by default on the AG-HPX500. V Mount is used by batteries from companies such as IDX.

HD/SD-SDI

SDI stands for "serial digital interface," one of the video signal transfer standards used by commercial video equipment. It allows transfer of uncompressed digital video of standard quality and digital audio over a single coaxial cable connected using BNC connectors. HD-SDI is the standard for transferring HD video and SD-SDI is for SD video. The video signal is transferred as both a component signal and as a composite signal, but these two formats are not compatible with each other.

Hot Swap

This function makes it possible to replace P2 cards that are not in use while the P2cam is operating or recording.

ING

ING stands for "IT news gathering." The P2 system proposed and advanced by Matsushita Electric Industrial aims to replace conventional ENG (electric news gathering) with ING employing advanced information technology (IT).

MXF File

MXF stands for "material exchange format," a general-use media container format used in the video industry. It functions as a container for storing and transferring video and audio data as well as related metadata. Video and audio data using a variety of sizes, codecs, and sampling rates can be stored. MXF is not a compression format or video type. P2 uses the MXF wrapper to store data in formats such as DV, DVCPRO, DVCPRO 50, and DVCPRO HD. The use of the MXF wrapper makes it possible to transfer and store specialized media data using general-use computer systems. It also provides compatibility with multiple media types.

Native Mode

In native mode the video data is recorded on the P2 card at the frame rate used by the camera, such as 720/24pN, 720/25pN, or 720/30pN. Only valid frames are recorded, extending the recording time.

Shot Marker

This is a marking function that can be used, for example, to distinguish between good takes and outtakes. A shot marker may be added to each clip in the P2 data. Marks may be added or removed during or after recording. It is possible to display only marked clips when mounting video data on a PC (using P2Viewer).

Span Files

Span files are created when a video file is recorded spanning two or more P2 cards. When P2Viewer or a nonlinear editing (NLE) system supporting P2 is used, a set of span files is treated as a single video file rather than as multiple files.

Text Memo

By pressing the Text Memo button during video recording or preview, you can record blank text memos wherever you want (up to a maximum of 100 memos). Later you can search for memos using P2Viewer and insert appropriate text, such as the shooting location or scene information.

Non-linear Editing Terms

Redundant and Duplicate Frames

In the FCP manual the term "duplicate frames" is used to refer to cases where the same material is used two or more times in a single timeline, and "redundant frames" refers to cases where multiple instances of the same frame exist before pull-down processing. However, in new information concerning FCP5, "duplicate frames" is used in place of "redundant frames," so the terms may be considered as interchangeable.

Production Note

AG-HPX500 Camera Operation; HIDEUMI OKA / Videonetwork

NLE Engineer : KOTARO TAKANO / VFX Director

Model : YOU TEJIMA

Still Camera: HYOJI OHFUDE (Studio OXI), MITSUKO HONDA

Design : MORIHIRO YAKABI

Special Thanks to : MASANORI(Igrec.co.,Ltd), NAOYA TAIRA, YUZO FUSE, SANAE ITO

Kurosawa Film Studio

Edit : Yukihiko Ishikawa / Editor in Chief DVJAPAN



P2HD × AG-HPX500
PRACTICAL GUIDEBOOK