

# PENTAX®

## smc PENTAX-D FA INTERCHANGEABLE LENS OPERATING MANUAL

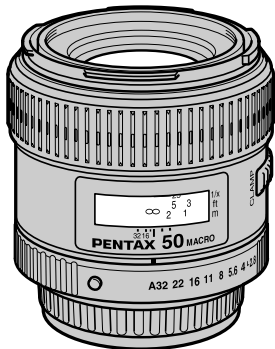

## FOREWORD

Thank you for purchasing the smc PENTAX-D FA lens.

The smc PENTAX-D FA lens is an interchangeable lens for Pentax SLR cameras. Its image circle covers the 35mm film format, and it also obtains optimum image clarity with Pentax digital SLR cameras. When the lens is used with an *\*istD*-series digital SLR camera, the Quick-Shift Focus System enables manual touch-up focusing after autofocus is achieved. For details, see page 12.

Before using the lens, read this manual carefully for proper use. Also refer to your camera's manual for more information.

- ※ In this operating manual, “smc PENTAX-D FA lens” is shortened to “D FA lens.”
- ※ The items appearing in the illustrations may look different from the actual product.
- ※ PENTAX and smc PENTAX are trademarks of PENTAX Corporation.

Although we have carefully designed these lenses for safe operation, please pay special attention to items marked with the following symbols when using this product.



## **WARNING**

This mark indicates precautions that if not followed, could result in serious injury to the user.



## **CAUTION**

This mark indicates precautions that if not followed, could result in minor or medium injury to the user or damage to the equipment.



## **WARNING**

- **Never look at the sun through the lens or camera. Serious damage to the retina, or total loss of eyesight may occur.**



## **CAUTION**

- **Do not leave the lens in direct sunlight without lens caps. Direct sunlight passing through the lens will be intensified, and should it focus on flammable materials, fire may occur.**

### 1. Storage and mildew prevention

- Take the lens out of the protective case or camera bag, and store it in a dry, well-ventilated place.
- Avoid storing the lens in a poorly ventilated location such as a closet, wardrobe, drawer, vehicle, or where insect repellent or medicine is kept.
- Avoid storing the lens in areas of high temperature and humidity, where there is a risk of mildew growth.

Store the lens with a desiccant in a dry cabinet, airtight container, or plastic bag. (Leaving a saturated desiccant in the storage container can cause damage to the lens. Be sure to read the instructions that came with the desiccant before use.)

2. The lens is not waterproof. When using the lens in a rain or mist, be careful not to allow it to get wet.
3. Never use any organic solvent such as thinner, alcohol, or benzine, etc. to remove dust on the lens.
4. The lens is a precise optical instrument. Be careful not to let it fall, or subject it to strong shocks or pressure. Use a cushion or similar pad to protect the lens from the vibrations of motorcycles or other vehicles, boats, etc.

5. Avoid subjecting the lens to rapid changes in temperature, otherwise condensation can occur on both the inside and the outside of the lens. Put the lens in a plastic bag or camera bag, and take it out after the lens has reached ambient temperature.
6. When the lens is not attached to the camera body, attach both the supplied lens cap and lens mount cap to protect it from dust.
7. Do not leave the camera with the lens cap off attached to a tripod or other rigid camera support. The inner parts of the camera can be damaged by direct sunlight.
8. Have the lens inspected by a dealer every one or two years to maintain its high performance.

◦ FOREWORD	
◦ FOR SAFE USE OF YOUR LENS .....	1
◦ PRECAUTIONS AND LENS MAINTENANCE .....	2
◦ smc PENTAX-D FA LENS .....	6
• About the Lens Mount .....	7
• Camera/Lens Mount Compatibility .....	8
◦ MOUNTING AND REMOVING THE LENS .....	9
◦ FOCUSING .....	10
• Switching the Focus Mode .....	10
• Using Autofocus .....	10
• Using Manual Focus .....	11
• Using the Quick-Shift Focus System ( <i>*istD</i> -series cameras only) .....	12
• How to use the Quick-Shift Focus System .....	12
◦ HOW TO USE THE INFRARED INDEX .....	13
◦ APERTURE CONTROL .....	14

○ <b>MACRO LENS</b> .....	16
• Magnification Scale .....	17
• About the Clamp Switch .....	18
○ <b>LENS HOOD</b> .....	19
○ <b>FILTERS</b> .....	20
• Precaution on filters .....	20
○ <b>PRECAUTIONS WHEN USING THE LENS WITH A FLASH</b> .....	21
• Built-in Flash .....	21
○ <b>MAIN SPECIFICATIONS</b> .....	22

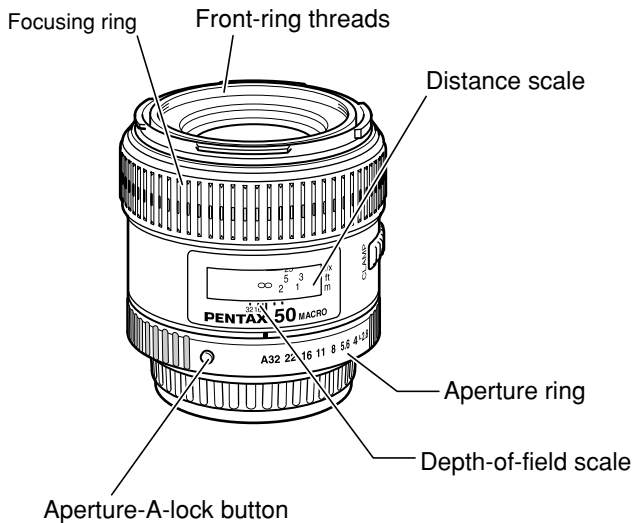



## About the Lens Mount

The D FA lens mount is called the “K<sub>AF</sub> - mount.” This lens mount enables autofocus and autoexposure.

K<sub>AF</sub>-mount

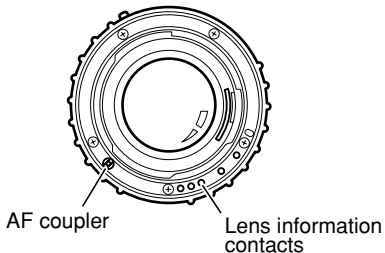

### CAUTION

Be careful not to damage or dirty the lens information contacts and AF coupler on the mount surface of the lens. Otherwise, failure or malfunction may result.

## Camera/Lens Mount Compatibility

Pentax camera/lens mount compatibility chart is shown below.

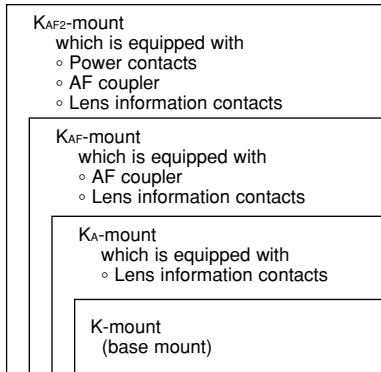

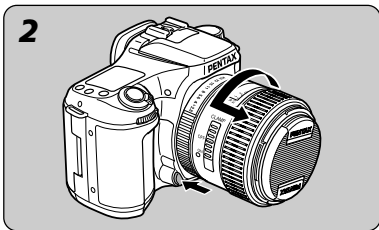
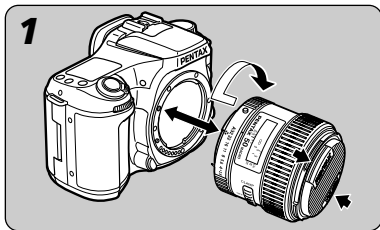

### 1. To mount the lens on the camera body

Align the red dots on the lens and camera body, and then turn the lens clockwise until it clicks into place.

Push the tabs in the directions shown by the arrows to remove the lens cap. Attach the lens cap when the lens is not used.

#### **Memo:**

- Do not hold down the lens unlock button while mounting the lens, otherwise the lens will not be properly mounted.
- After mounting the lens, gently turn the lens counterclockwise to make sure it is locked in place.

### 2. To remove the lens

Hold down the lens unlock button on the camera body and turn the lens counterclockwise.

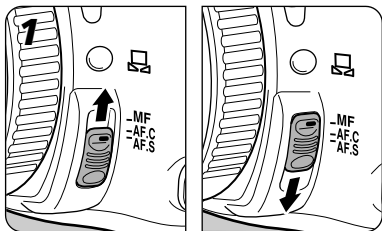

## 1. Switching the Focus Mode

Use the camera's focus mode switch to change between the autofocus mode and manual-focus mode. For details, refer to your camera's manual.

- If you use the lens with a manual-focus camera, focus the lens manually.

## 2. Using Autofocus

Set to autofocus with the camera's focus mode, and press the shutter button halfway or press the AF button of *\*istD* and MZ-S to autofocus.

- Note that during the autofocus operation, the D FA lens' focusing ring does not rotate. However, do not turn the focusing ring during the autofocus operation. Doing so will cause a malfunction.

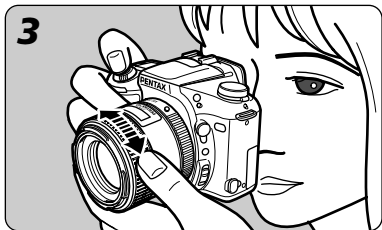

### 3. Using Manual Focus

Set to MF with the camera's focus mode, and turn the focusing ring to focus manually.

- If the lens is used with a camera, you must set the focus mode switch to MF before you focus manually.

#### **Note:**

When focusing manually, do not turn the focusing ring all the way to infinity or to the minimum focusing distance.

## Using the Quick-Shift Focus System ( *\*istD* -series cameras only)

If you use the lens with an *\*istD* camera and the focus mode is set to autofocus, you can focus manually after autofocus is achieved. Just turn the focusing ring to manually touch-up the focus. You can do this without switching the focus mode to MF.

### How to use the Quick-Shift Focus System

#### 1. Using Autofocus

Set the camera's focus mode switch to autofocus, then press the shutter button halfway (or press the AF button) to autofocus.

#### 2. Adjust the focus by turning the focusing ring.

#### 3. Finally, press the shutter release button to take the picture.

#### CAUTION

- During the autofocus operation, the focusing ring does not rotate. Do not turn the focusing ring during the autofocus operation. Doing so will cause a malfunction.
- When using the Quick Shift Focus System, keep pressing the shutter button (or AF button) after you achieve focus and before taking the picture. If you let go of the shutter button before taking the picture, you will have to focus all over again when you press the shutter button again.

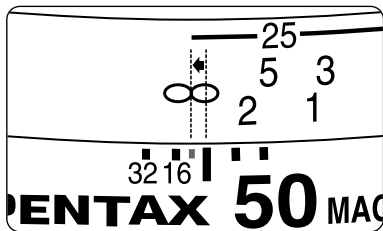
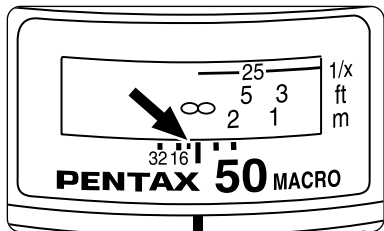

If you use infrared film and attach an R2 or O2 filter to the lens to take infrared pictures, the point of focus will be different from when you shoot normally (with visible light). A focusing correction will be necessary. As shown above left, memorize the focusing point on the lens distance scale when viewed through the viewfinder and turn the focusing ring until the point you memorized aligns with the infrared index, red dot, as shown above right.

- Infrared film can not be used for MZ-S, MZ-60 and \*ist since infrared ray is used for detecting device of film transport. It will expose infrared film in the camera.
- Turn the focusing ring in the MANUAL focus mode only.
- For the exposure control required in this special photography, see the information supplied with the infrared film.

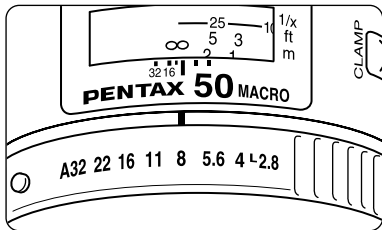
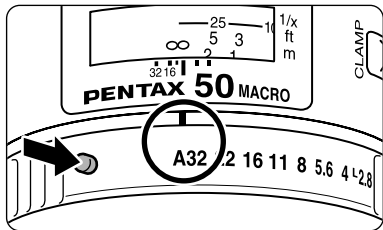

### Setting the aperture to "A"(Auto)

Turn the aperture ring to align the aperture-A index with the white line while depressing the Aperture-A-lock button. The aperture ring can be released from "A" in the same manner to set your desired f-stop manually.

- If the camera has the K<sub>AF2</sub> lens mount and the aperture is not set to A, the approximate aperture setting will be displayed on the display panel and in the viewfinder.
- If the camera has the K lens mount which has no electronic contacts to transmit the lens information, set the aperture to any f-stop other than A.



## Aperture Ring Cautions

The following restrictions apply to the respective cameras below.

<p><i>*istD</i> -series, <i>*ist</i></p>	<p>If the camera is set to the default settings and the aperture ring is not set to A, the camera will not work. Be sure to set the aperture ring to A and set the aperture with the camera. Although you can use the Custom Function menu or C Custom menu to enable camera operation while the aperture ring is not set to A, restrictions will apply. Refer to the camera's manual for details.</p>
<p>MZ-60, MZ-30 MZ-50</p>	<p>If the aperture ring is not set to A, the camera will not work. Be sure to set the aperture ring to A and set the aperture with the camera.</p>

The D FA Macro 50mm f/2.8 and D FA Macro 100mm f/2.8 lenses enable closeup photography up to 1x magnification.

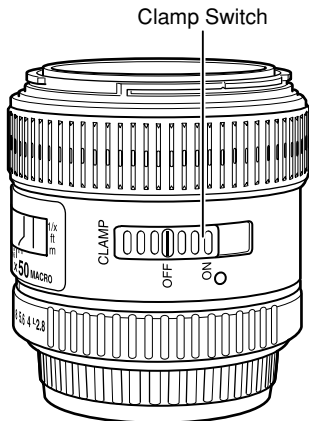

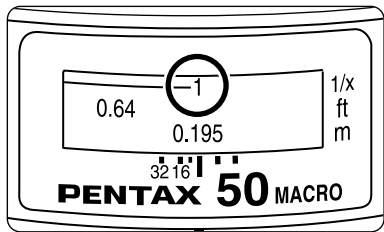

### Magnification Scale

The magnification is indicated by denominators on the distance scale. "1" indicates "1x". For example, "1" on the magnification scale at the top will make the magnification 1/1x. If you want to set the magnification first, turn the focusing ring to set the desired magnification. Then focus the subject by moving the camera forward or back.

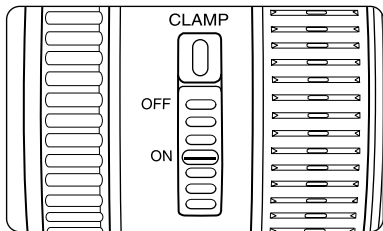

### About the Clamp Switch

The D FA Macro 50mm f/2.8 and D FA Macro 100mm f/2.8 lenses are equipped with a Clamp switch which is convenient for manual focus.

The Clamp switch locks the manual focus position. You can use it when taking close-ups with a copy stand, for example.

### Using the Clamp Switch

Focus manually, then set the Clamp switch to ON.

The point of focus will be locked. Autofocus will also be disabled.

- Do not turn the focusing ring forcibly while setting the Clamp switch to ON because there is a slight possibility that the point of focus may change.
- If you use the Clamp switch with any of the following cameras, be sure to first set the camera's focus mode switch to MF.

Z-10, Z-20, Z-20P, Z-50 P, Z-70P, MZ-5, MZ-10, and MZ-50

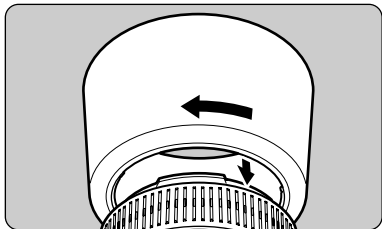

Using a lens hood is recommended to block stray light from entering the lens. The stray light's internal reflections degrade the image quality.

### **Lens hood for D FA lens**

#### **How to attach**

Put the hood on the lens, and turn it as shown by the arrow until it clicks in place.

#### **Memo:**

- When the lens hood is not in use, it can also be turned around and attached in the reversed position.

The filter is mounted into the screw thread in front of the lens.

**Precaution on filters**

- Since the filter becomes a part of the optics when attached on the lens, handle it in the same way you handle the lens with care to dust, dirt and scratches. Avoid using more than one filter, unless it is a circular polarizing filter. Using two or more filters will degrade the image quality and the filter effect will not be obtained.
- Use a circular polarizing filter with Autofocus camera for proper exposure and autofocusing.

**Built-in Flash**

The built-in flash can not be used when the distance is less than 0.7m. When the flash is used within 0.7m, it causes incorrect exposure control.

- If the built-in flash is used with the lens hood attached to the lens, the flash light will be blocked by the lens hood. Always make sure to remove the lens hood before using the built-in flash.

Lens	smc PENTAX-D FA Macro 100mm f/2.8
Elements in groups	9-8
Angle of view	24.5° (16° when attached to <i>*istD</i> -series)
Aperture	f/2.8
Mount type	K <sub>AF</sub> -mount
Minimum focus distance	0.303m (0.99ft) (0.130m (0.45ft) working distance)
Maximum magnification	1×
Filter size	49mm
Lens hood	PH-RBB 49mm (provided)
Max. Diameter x Length	67.5mm × 80.5mm (2.6in × 3.2in)
Weight	345g/12.2oz
Soft case	S80-120



Lens	smc PENTAX-D FA Macro 50mm f/2.8
Elements in groups	8-7
Angle of view	47° (31.5° when attached to <i>*istD</i> -series)
Aperture	f/2.8
Mount type	K <sub>AF</sub> -mount
Minimum focus distance	0.195m (0.64ft) (0.047m (0.15ft) working distance)
Maximum magnification	1×
Filter size	49mm
Lens hood	PH-RBC 49mm (provided)
Max. Diameter x Length	67.5mm × 60mm (2.6in × 2.6in)
Weight	265g/9.3oz
Soft case	S80-80

**Specifications and external dimensions are subject to change without notice.**

**Memo :**

---

---

---

---

---

---

---

---

---

---

---

---

---

---

---

## For customers in the USA

### STATEMENT OF FCC COMPLIANCE

This device complies with Part 15 of the FCC Rules. Operation is subject to the following two conditions : (1) This device may not cause harmful interference, and (2) this device must accept any interference received, including interference that may cause undesired operation.

Changes or modifications not approved by the party responsible for compliance could void the user's authority to operate the equipment.

This equipment has been tested and found to comply with the limits for a Class B digital device, pursuant to part 15 of the FCC Rules. These limits are designed to provide reasonable protection against harmful interference in a residential installation. This equipment generates, uses and can radiate radio frequency energy and, if not installed and used in accordance with the instructions, may cause harmful interference to radio communications. However, there is no guarantee that interference will not occur in a particular installation. If this equipment does cause harmful interference to radio or television reception, which can be determined by turning the equipment off and on, the user is encouraged to try to correct the interference by one or more of the following measures :

- Reorient or relocate the receiving antenna.

Increase the separation between the equipment and receiver.

Connect the equipment into an outlet on a circuit different from that to which the receiver is connected.

\*Consult the dealer or an experienced radio/TV technician for help.

## For customers in the Canada

This Class B digital apparatus meets all requirements of the Canadian Interference-Causing Equipment Regulations.

Cet appareil numérique de la classe B respecte toutes les exigences du Règlement sur le matériel brouilleur du Canada.

- PENTAX Corporation** 2-36-9, Maeno-cho, Itabashi-ku, Tokyo 174-8639, JAPAN (<http://www.pentax.co.jp/>)
- PENTAX Europe GmbH** Julius-Vosseler-Strasse, 104, 22527 Hamburg, GERMANY  
**(European Headquarters)** (HQ - <http://www.pentaxeurope.com>) (Germany - <http://www.pentax.de>)
- PENTAX U.K. Limited** PENTAX House, Heron Drive, Langley, Slough, Berks SL3 8PN, U.K. (<http://www.pentax.co.uk>)
- PENTAX France S.A.S.** 12/14, rue Jean Poulmarch, 95106 Argenteuil Cedex, FRANCE
- PENTAX Benelux B.V.** (for Netherlands) Spinveld 25, 4815 HR Breda, NETHERLANDS (<http://www.pentax.nl>)  
(for Belgium & Luxembourg) Weiveldlaan 3-5, 1930 Zaventem, BELGIUM (<http://www.pentax.be>)
- PENTAX (Schweiz)** AG Widenholzstrasse 1 Postfach 367 8305 Dietlikon, SWITZERLAND (<http://www.pentax.ch>)
- PENTAX Scandinavia AB** P.O. Box 650, 75127 Uppsala, SWEDEN (<http://www.pentax.se>)
- PENTAX Imaging Company**  
**A Division of PENTAX of America, Inc.**  
(Headquarters)  
600 12th Street, Suite 300 Golden, Colorado 80401, U.S.A.  
(Distribution & Service Center)  
16163 West 45th Drive, Unit H Golden, Colorado 80403, U.S.A. (<http://www.pentaximaging.com>)
- PENTAX Canada Inc.** 1770 Argentia Road, Mississauga, Ontario L5N 3S7 CANADA (<http://www.pentaxcanada.ca>)



for your  
precious moments



The CE Mark is a Directive conformity mark of the European Community.

Copyright © PENTAX Corporation 2004