



MODEL : STm.57w
MOBILE PRINTER



**RISK OF EXPLOSION IF BATTERY IS REPLACED BY AN INCORRECT TYPE.
DISPOSE OF USED BATTERIES ACCORDING TO THE INSTRUCTION**



Disposal of Old Electrical&Electronic Equipment(Applicable in the European Union and other European countries with separate collection systems)

This symbol on the product or on its packaging indicates that this product shall not be treated as household waste. Instead it shall be handed over to the applicable collection point for the recycling of electrical and electronics equipment. For more detailed information about recycling of this product, please contact your local city office, your household waste disposal service or the shop where you purchased the product.

Table of Contents

1. Unpacking	2
2. Product overview	3
3. Installation & Usage	4
3-1. Control Panel Usage	4
3-2. Battery Installation	5
3-3. Battery removal	6
3-4. Battery Charging	7
3-5. Battery Charger Usage	8
3-6. Usage of Cigar Jack for charging	9
3-7. Belt clip usage	10
3-8. Roll Paper Installation	11
3-9. Leather case Usage	12
3-10. Shoulder Strap Usage	13
3-11. Self Test	14
4. Peripherals Connection	17
4-1. Wifi(802.11b/g) Connection	17
4-2. Interface Cable Connection	18
5. Printer Cleaning	19
6. Product Specification	20
6-1. Specification	20
7. CPCL Command Compatibility	22

1. Unpacking

Standard

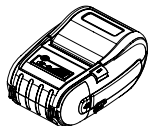

Printer

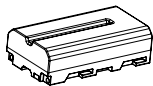

Battery



Belt Buckle

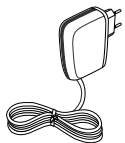

Recharger

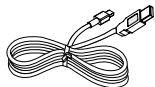

USB Shilded Cable

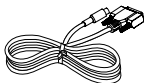

Serial Cable

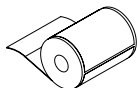

Roll paper

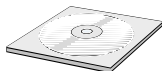

CD



Quick Manual

Optional



Battery Holder
(Cradle)



Cigar jack



Printer case

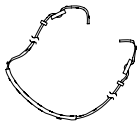

shoulder strap

2. Product overview

Front

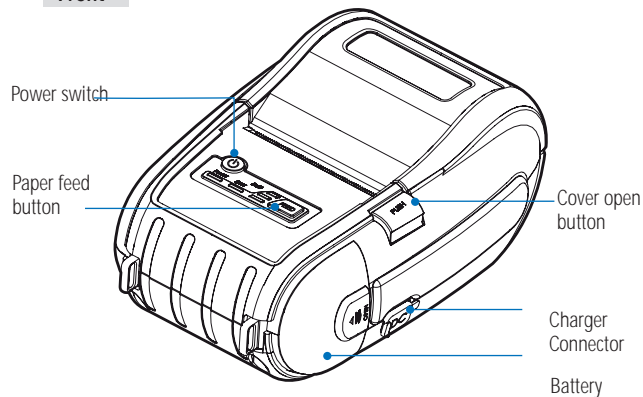

Side

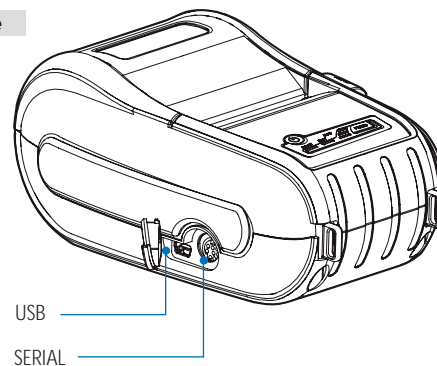

3. Setting Up the Product

3-1. Control Panel Usage

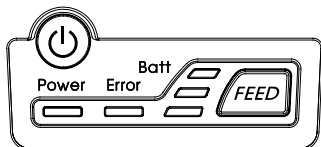

Button	Name	function
	Power button	This button is used to turn the printer on and off. When the printer is off, press this button for approximately 2 seconds and it will turn on the power. When you press this button in a state that the printer is on, the printer will turn off.
	Paper Feed Button	Paper output can be done manually by pressing this button. Additionally, self-testing and Hexadecimal Dumping can be processed. 1. Refer to "3-10" for self test information. 2. Refer to the service manual regarding Hexadecimal Dumping.
	Battery Status Lamp	1. If the Batt, LED are Lit, the battery is fully charged. 2. If you can hear beeping sound and LED light is turned off, it means that the battery is at the lowest level. 3. If the battery is not charged at all, the printer turns off automatically.
	Error Lamp	If the red light is turned on, it means that the paper cover is open.

3-2. Installing battery

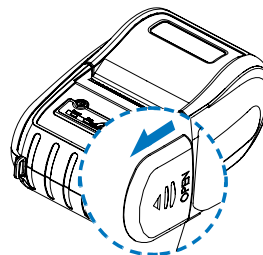

Push the Open to the direction as pointed by arrow in the image.

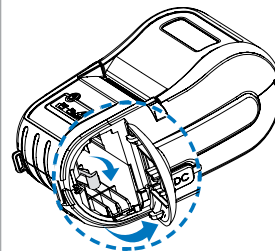

Open the battery cover and push up the hook to the direction as above.

1 2
3

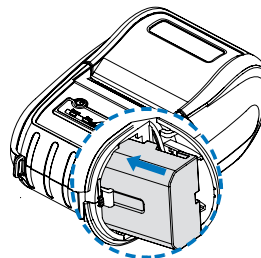

Insert the battery inside printer as shown.

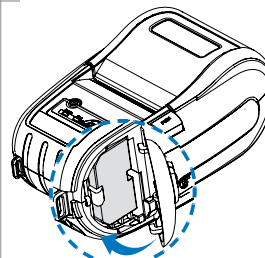

Close the battery cover once you inserted the battery completely.

NOTE

As the battery is not charged at the time of your purchase, charge the battery prior to using the product.
(Use the battery charger and/or the optional battery holder.)

3-3. Battery removal

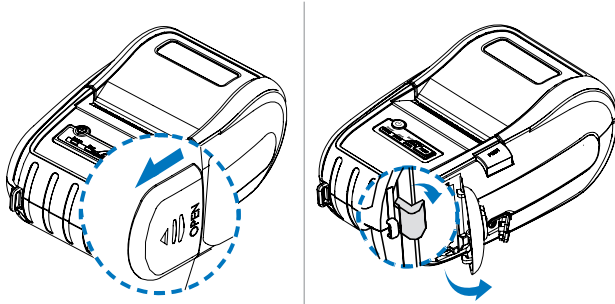

Push the Open into the direction indicated with the arrow in the image.

Push up the hook after opening the battery cover.

1 2
3

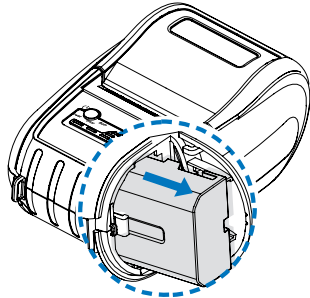

Pull out the battery as shown above.

3-4. Battery Charging

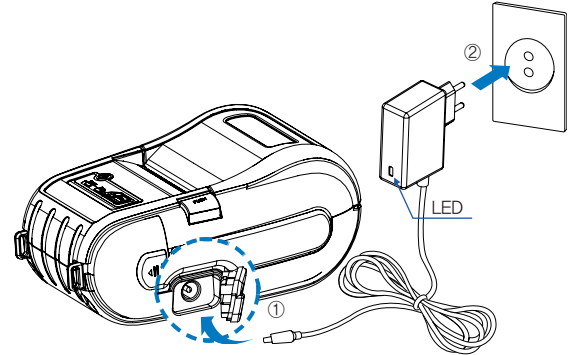

1. The battery can be charged only when the temperature is 0~40℃
2. Be sure that the printer is turn off and the battery to be charged is installed.
3. Connect the charger to the printer.
4. Recharging will now be started.

3-4-1 The status of lamp in charging

Status	charging	charging complete
Charging Lamp	Red	Green

NOTE

1. Unless the exclusive charger is used provided by the manufacturer, the printer can be damaged, and the manufacturer is not liable for the consequential damage.
2. Before removing the battery, make sure that power is turned off.
3. Printer does not work in the status of being connected with charger only.
4. The battery should be installed to operate printer.
5. While charging, do not turn on the power.
6. Do not operate the print while charging the battery.
7. Do not connect the charger while the printer is operated.

3-5. Battery charger Usage

Optional

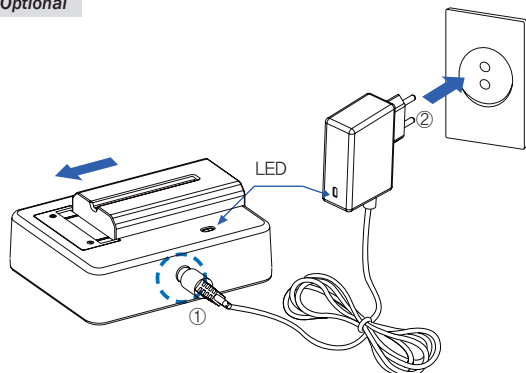

1. Please press the battery into the holder until you can hear a snapping sound.
2. Insert DC JACK ① into the end completely as the direct shown above.
3. Plug the power code to electrical outlet.
4. While charging the battery, red light turns on.
Once the charge is completed, green light turns on.
Check the state of code connection when error occurs blinking on red light.

3-5-1 The status of lamp in charging

Status	charging	charging complete
Charging Lamp	Red	Green

NOTE

In the case the battery is not fixed properly in the holder, the red lamp will be blinking.
Then, extract and reinsert the battery.

3-6 Usage of Cigar Jack Charger for charging

Optional

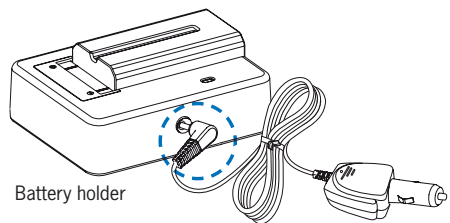
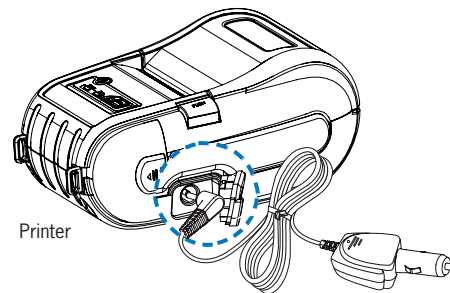

Connect the car cigar JACK charger into the printer or battery holder.

Input	12 ~ 24V
Output	8.4V 0.8 ~ 1.2A

NOTE

Use the Cigar Jack offered by the manufacturer.

3-7. Belt clip Usage

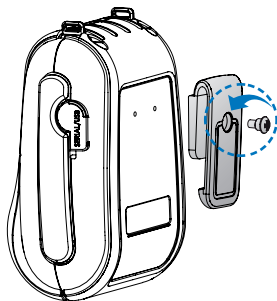

Insert the belt hook screw into the hole of the belt hook.

1
2

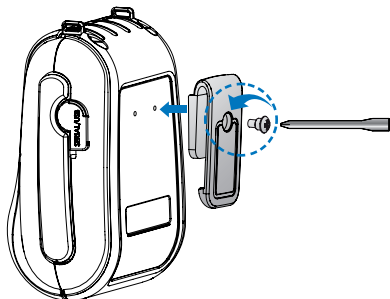

As shown above, fasten the screw with a screw driver.

3-8. Roll Paper Installation

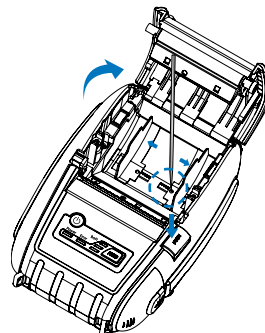

Open the paper cover pressing the open button. Insert a sharp tool into the paper guide hole and push it in the direction of arrow as shown above.

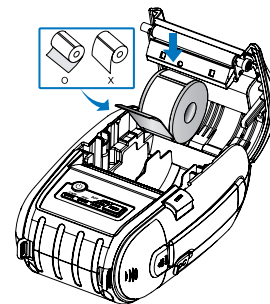

Put the paper in the right direction after adjusting the paper guide matching the paper width. (Remove the paper core when it is used all)

1 2
3 4

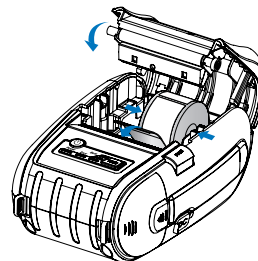

Pull out a short length of the paper and shut the paper cover.

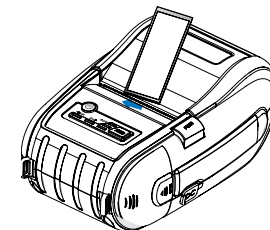

Press the Feed Key once to arrange the paper.

3-9. Leather Case Usage

Optional

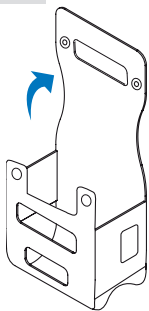

Open the Velcro

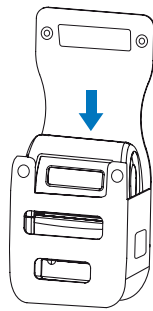

Put the printer into the leather case following the direction shown in the image.

1 2
3

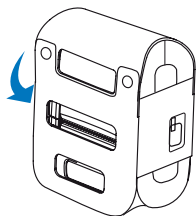

Close the Velcro

3-10. Shoulder Strap Usage

Optional

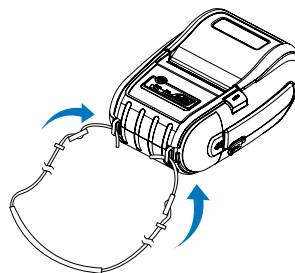

Insert the strap into the hook on the printer.

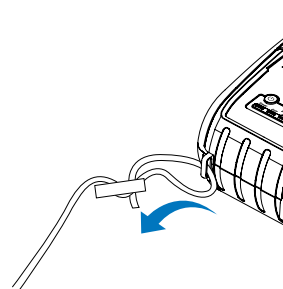

Place the end of strap into the hook of shoulder strap.

1 2
3 4

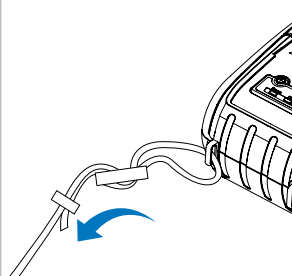

After pulling out the end of strap tightly, put it into the clip to be fastened.

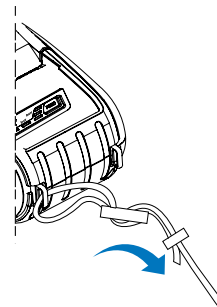

Fasten the strap in the opposite side with the same way.

3-11. Self Test

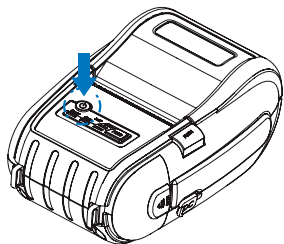

Turn off the power pressing the power button for approximately 3 seconds.

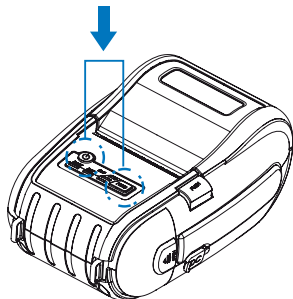

While you are pressing the FEED button, press the power button

1 2
3

NOTE

1. To print ASCII pattern additionally, press the Feed button once more
2. After printing ASCII pattern, the self test will be finished automatically.
3. If the Feed button is not pressed to print ASCII pattern, self test will be finished automatically after 30 seconds.

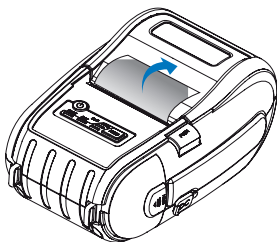

The printout is produced.

The sample of self test printout

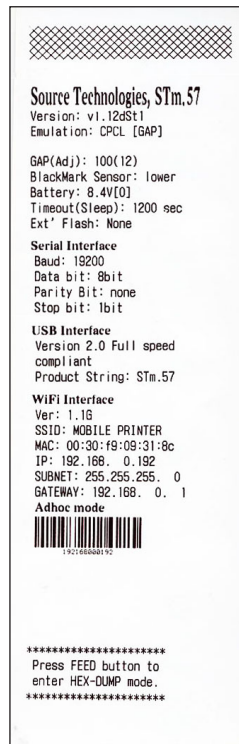

When the printer is installed initially or when you face a problem, you can run the self test and check the information about

-Control Circuit, Mechanism, Print Quality, ROM Version

After checking with self-test and no issues are found, you can examine other devices and software. This function is working independent of devices and software.

● **Motor protection from being overheated**

The motor should be stopped and cooled about more than 30 seconds after continuous printing 1.5 meter

4. Peripherals Connection

This product can communicate with other devices via Wifi(802.11b/g) communication and cable.

4-1 Wifi(802.11b/g) Connection

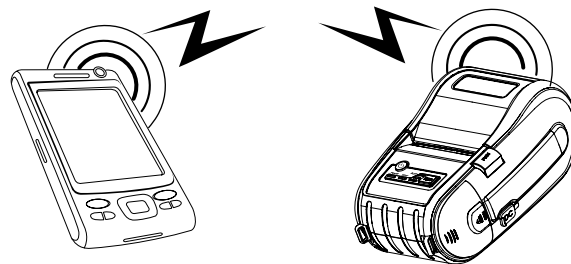

1. The Printer can be connected to devices equipped with wifi(802.11b/g) communication capacity (PDAs, PCs, etc.)
2. Use the wifi(802.11b/g) connection function supported by the device to connect to the printer.

✔ **NOTE**

Refer to the wifi(802.11b/g) Manual for more details on connection.

4-2. Interface Cable Connection

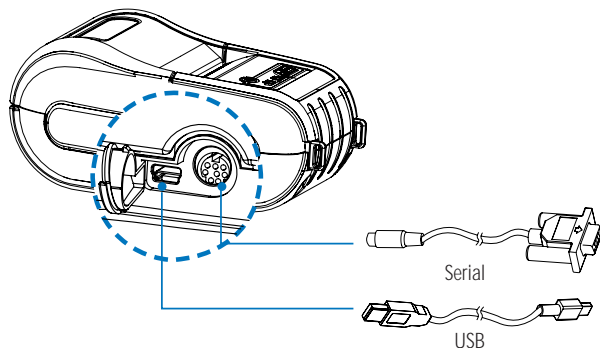

1. Connect USB or Serial cable into the cable connector on the printer.

✔ NOTE

Use the cable offered by the manufacturer (USB, Serial)

2. Connect the interface cable into the USB or Serial port of the device (PDA, PC, etc.)

5. Printer cleaning

If the interior of the printer is dusty, printing quality can lowered. In such a case, follow the instructions below to clean up the printer.

✔ NOTE

1. Make sure to turn the printer power off prior to cleaning
2. Regarding print head cleaning, as the print head sets very hot during printing, turn off the printer power and wait approximately 10 minute before commencement.
3. When cleaning the print head, take care not to touch the heated portion of the print head. The print head subject to be damaged by static electricity.
4. Take care not to allow the print head to become scratched and /or damaged in any way.

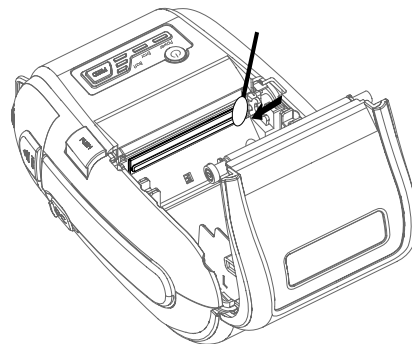

1. Use an applicator swab moistened with an alcohol solution to clean the print head and remove any dusts.
2. Once the cleaning is completed, insert paper roll into the printer few minutes later and close the printer cover.

✔ Preventing Overheating

To prevent the motor from overheating, continuous driving of the printer should be 1.5 m or less in print length. Set the pause time for 30 seconds or more after driving the printer.

6. Pritner Specification

6-1. Specification

Printing Method		Direct Thermal
Printing Speed		80mm/sec
Resolution		203 DPI X 203 DPI
Character		ALPHA NUMERIC Character, Extension Character
Barcode		Code 39, Code 93, UCC/EAN-128, Code 128, UPC-E, UPC-A, EAN-8, EAN-13, EAN-14, UPC and EAN 2 or 5 digit extensions, Plessey, FIM, Postnet, Interleaved 2-of-5, MSI, Codabar
Emulation		CPCL
Driver		Window CE 4.2&5.0, Window Mobile 5.0
Sensor		Black-mark, Gap, cover open
Paper	paper type	Thermal Paper
	width	58mm
	thickness	65 μ l
	External Diameter	Max. ϕ 56mm
	Internal Diameter	12.5mm +/-0.5mm
Reliability	TPH	100km
	Battery	Continuous Printing 54min Standby for 19hours Printing length: 249.8M
Communications	standard	Serial(RS-232C), USB, Wireless Lan *802.11b/g
Battery Charger	input	AC100~240V, 50/6 Hz
	output	8.4V , 800~1400mA
Battery	Battery type	Li-ion
	output	7.4V, 2200mAh
	Charging time	3hours 40min
Size	WXDXH(mm)	104 X 74 X 154
	WXDXH*	4.0 X 2.9 X 6.0

Weight		500g
Environmental sealing		IP42
Temperature	operation	5~40 $^{\circ}$ C
	storage	-20~60 $^{\circ}$ C
Humidity	operation	35 ~ 80%
	storage	10 ~ 90%

7. CPCL Command Compatibility

NOTE

Compatible	Compatible with only commanders provided by the manufacturer.	Partially Compatible	Not Compatible
○	●	△	x

Printer Commands	Compatibility
PRINT	○
FORM	○
JOURNAL	○
UNITS	○
Comments	○
TEXT	Compatibility
TEXT	○
FONT-GROUP(FG)	○
TEXT CONCATENATION	○
MULTILINE(ML)	○
COUNT	○
SETMAG	○
SCALABLE TEXT	X
Linear Bar Codes	Compatibility
BARCODE	○
BARCODE-TEXT	○
Two-Dimensional Bar Codes	Compatibility
PDF417 (PORTABLE DATA FILE)	○
MAXICODE	○
QRCODE	●
DATAMATRIX	●
GS1(RSS)	●

Graphics	Compatibility
BOX	○
LINE	○
INVERSE-LINE	○
PATTERN	○
GRAPHICS	○
PCX	○
Advanced Commands	Compatibility
CONTRAST	○
tone	○
JUSTIFICATION	○
PAGE-WIDTH	○
PACE	○
NO-PACE	○
WAIT	○
REWIND	X
TENSION	X
SPEED	○
SETSP	○
ON-OUT-OF-PAPER	X
ON-FEED	○
PREFEED	○
POSTFEED	○
PRESENT-AT	X
COUNTRY/CODE PAGE	○
FORMAT FILES	○
BEEP	○
CUT	X
PATIAL-CUT	X
MCR	●

Line Print Mode	Compatibility
SETLP	○
SETLF	○
Moving With X and Y Coordinates	○
LMARGIN	○
SETBOLD	○
SETSP	○
Special ASCII Characters	○
SETFF	○
SET-TOF	○
SETLP-TIMEOUT	○