

# Installation and Operation Guide



## PowerVu® Model D9225 Headend Satellite Receiver





# Quick Setup Guide

If receiver setup details are unavailable, you can perform a Quick Setup of your Headend Satellite Receiver by following the step-by-step instructions in this Quick Setup Guide. After performing the Quick Setup, you can change the current settings to better suit your receiver operating requirements. If you are unsure about which settings to use, contact your dealer/reseller or local service provider for assistance. For complete receiver setup information, see the Model D9225 Headend Satellite Receiver Installation and Operation Guide.

TO REMOVE, TEAR ALONG PERFORATION



**IMPORTANT:** Only preauthorized subscriber services can be made available for your Headend Satellite Receiver. If a unauthorized signal is present, a warning message displays on the TV monitor. In this case, contact your dealer/reseller or local service provider about satellite broadcast services authorization.

## ...About the Video Standard

The Video Standard used to operate the receiver is preset at the factory to either NTSC (525-line) or PAL (625-line), depending on factory-installed options.



**IMPORTANT!** The current Video Standard setting is used by the receiver for correct display of the video (picture) only. The satellite receiver does not convert from one Video Standard to another, such as from NTSC (525-line) to PAL-B (625-line).

## Receiver Startup

**Step 1. Check your installation:**

- (a) Check that the receiver is correctly installed and connected to the satellite LNB antenna, to other A/V equipment (as required) and to AC power.
- (b) Verify that the satellite LNB power switch at the receiver rear panel is correctly set (OFF to use the external LNB power source, or ON to use the internal receiver LNB power source).

**Step 2. Power-on the receiver:** Press the STANDBY front panel button (1).

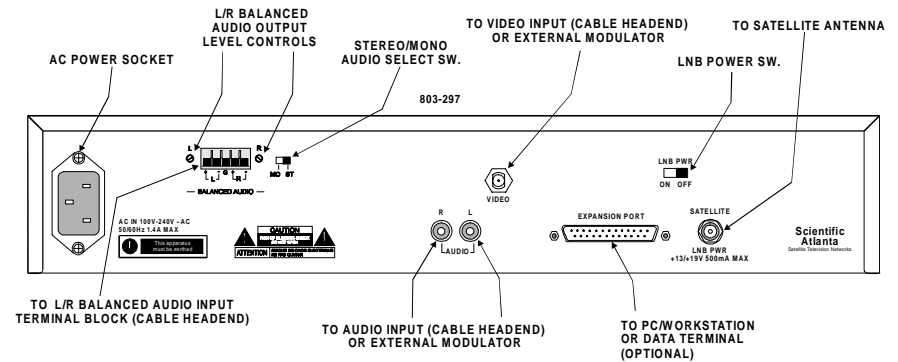

Figure A. TV & RF plus optional connections

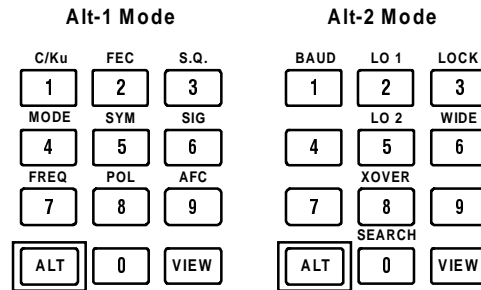

Figure B. Front panel Alt-1 and Alt-2 Mode function buttons

**Step 3. Change the video standard [if required]:**

- (a) Press and hold the SELECT button (3), then (b) Press the **↑** arrow button (4) once to replace the current setting. (c) Press the **↑** arrow button again (4) to select the alternate video standard.

**To use the ON/STANDBY, MENU, SELECT and arrow buttons...**

- (1) Press **STANDBY**.....
- (2) Press **MENU**.....
- (3) Press **SELECT**.....
- (4) Press **↑** and **↓**.....
- (5) Press **←** and **→**.....

## Quick Setup instructions

Follow these quick setup instructions to set up the receiver via the menu interface using front panel buttons, and to find a signal using the built-in signal search function. To operate the menu interface, a RF cable must be connected from the receiver VIDEO output to a TV monitor UHF/VHF RF input (see Figure A).

**Step 1.** Power ON the receiver by pressing the STANDBY button.

**Step 2.** Display the MAIN MENU by pressing the MENU button.

**Step 3.** Display the RECEIVER STATUS menu by pressing 2 and then SELECT, or move to Receiver Status and press SELECT.

**Step 4.** Display the RECEIVER SETUP menu by pressing 3 and then SELECT, or move to Receiver Setup and press SELECT.

**Step 4.** Change the Local Oscillator #1 frequency:

- (a) Move to L.O. Freq #1 and press SELECT to unlock the current setting
- (b) Enter the L.O. #1 Frequency (in GHz) based on C or Ku-Band LNB operation and press SELECT (e.g., 10750 for Ku-Band, and 5150 for C-Band).

**Step 5.** Change the Symbol Rate:

- (a) Move to Symbol Rate and press SELECT to unlock the current setting
- (b) Enter the Symbol Rate (in MS/s) and press SELECT.

**Step 6.** Change the FEC Rate: by moving to FEC Rate and pressing SELECT to display available FEC Rates.

**Step 7.** Activate the signal search to “Find” the signal (use only if the operating frequency is unknown) by moving to Find and pressing SELECT (set to ON). The “Lock, Sig” Signal State is displayed when a signal is found.

**Step 8.** Save the settings: (after signal found)

- (a) Press 1 and then SELECT, or move to Exit and press SELECT to display the Save pop-up menu.
- (b) Press 1 to save the new configuration (YES).

When the signal is found, the Find option is automatically set to OFF. Repeat this action to search for another signal. You can perform these functions using the following front panel buttons.

- Save:** Press and hold down both the ← and → arrow buttons simultaneously (5) to save the new configuration (YES)
- Discard:** Press and hold down both the ↑ and ↓ arrow buttons simultaneously (4) to discard all changes (NO)
- Cancel:** Press SELECT (3) to cancel the operation (CANCEL)



**WARNING!** Saved settings are automatically restored when the receiver is restarted after AC power is switched off or interrupted. Upon restarting, the receiver defaults to the virtual channel previously displayed for more than 20 seconds after exiting from menus (see also “...About saving changes” in the Installation and Operation Guide).

Table A. Factory default settings

	Option	Menu	Default setting
1.	Frequency Mode	Receiver Setup	L-Band/1
2.	Frequency	Receiver Setup	950 MHz
3.	Local Oscillator #1	Receiver Setup	9.750 GHz
4.	Local Oscillator #2	Receiver Setup	10.600 GHz
5.	Crossover	Receiver Setup	11.700 GHz
6.	Polarization	Receiver Setup	H (Horizontal)
7.	FEC Rate	Receiver Setup	7/8
8.	Symbol Rate	Receiver Setup	28.3465 Msymbols/sec.
9.	Network ID	Receiver Setup	1
10.	Lock Level	User Setup	0
11.	Bouquet ID	User Setup	0
12.	TV Audio	User Setup	Left + Right
13.	Baud Rate	User Setup	9600
14.	Aspect Ratio	User Setup	Normal
15.	Local Time	User Setup	12:00 AM
16.	IR Remote	User Setup	Disabled (OFF)
17.	Date Format	User Setup	US
18.	Video Standard	User Setup	AUTO
19.	Subtitles Language	User Setup	Arabic
20.	Password	User Setup	1234
21.	Search Mode	Search Setup	OFF
22.	Search Type	Search Setup	Frequency
23.	Lower Range	Search Setup	950 MHz
24.	Upper Range	Search Setup	2150 MHz
25.	IQ Select	Search Setup	Automatic

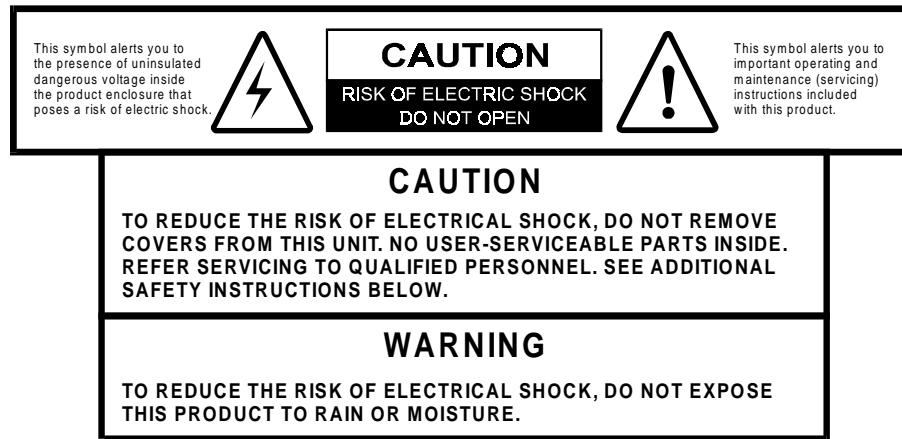

## IMPORTANT SAFEGUARDS

**Read Instructions:** All the safety and operating instructions should be read before this product is operated.

1. **Retain Instructions:** The safety and operating instructions should be retained for future reference.
2. **Heed Warnings:** All warnings on the product and in the operating instructions should be adhered to.
3. **Follow Instructions:** All operating and use instructions should be followed.
4. **Cleaning:** Unplug this product from the wall outlet before cleaning. Do not use liquid cleaners or aerosol cleaners. Use a damp cloth for cleaning.
5. **Attachments:** Do not use attachments not recommended by Scientific-Atlanta as they may cause hazards.
6. **Water and Moisture:** Do not use this product near water - for example, near a bath tub, wash bowl, kitchen sink, or laundry tub, in a wet basement, or near a swimming pool, and the like.

7. **Accessories:** Do not place this product on an unstable cart, stand, bracket, or table. The product may fall causing serious injury to a child or adult, and serious damage to the product. Use only with a cart, stand, bracket, or table recommended by Scientific-Atlanta. Any mounting of the product should follow the instructions, and should use a mounting accessory recommended by Scientific-Atlanta.  
An appliance and cart combination should be moved with care. Quick stops, excessive force, and uneven surfaces may cause the appliance and cart combination to overturn.

### PORTABLE CART WARNING



8. **Ventilation:** Slots and openings in the cabinet are provided for ventilation and to ensure reliable operation of the product, and to protect it from overheating. These openings must not be blocked or covered. The openings should never be blocked by placing the product on a bed, sofa, rug, or other similar surface. This product should not be placed in a built-in installation such as a bookcase or rack unless proper ventilation is provided or the instructions have been adhered to.

9. **Heat:** This product should be located away from heat sources such as radiators, heat registers, stoves or other products (including amplifiers) that radiate heat.
10. **Power Sources:** This product should be operated only from the type of power source indicated on the marking label. If you are not sure of the type of power supply in your home or business, consult your appliance dealer or local power company. For products intended to operate from battery power, or other sources, refer to the operating instructions supplied with the product. For applications other than in North America, a suitable attachment plug adapter should be used for connection to the power source. For determining the appropriate attachment adapter type, refer to qualified technical personnel.
11. **Polarization:** This product may be equipped with a polarized alternating current line plug (i.e., a plug having one blade wider than the other). This plug will fit into the power outlet only one way. This is a safety feature. If you are unable to insert the plug fully into the outlet, try reversing the plug. If the plug should still fail to fit, contact your electrician to replace your obsolete outlet. Do not defeat the safety purpose of the polarized plug.
12. **Power Cord Protection:** Power-supply cords should be routed so that they are not likely to be walked on or pinched by items placed upon or against them, paying particular attention to cords at plugs, convenience receptacles, and the point where they exit from the appliance.
13. **Lightning:** For added protection for this product during a lightning storm or when it is left unattended and unused for long periods of time, unplug it from the wall outlet and disconnect the antenna or cable system. This will prevent damage to the product due to lightning and power-line surges.
14. **Power Lines:** An outside antenna system should not be located in the vicinity of overhead power lines or other electric light or power circuits, or where it can fall into such power or circuits. When installing an outside antenna system, extreme care should be taken to keep from touching such power lines or circuits as contact with them might be fatal.
15. **Overloading:** Do not overload wall outlets, extension cords or integral convenience receptacles, as this can result in a risk of fire or electric shock.
16. **Object and Liquid Entry:** Never push objects of any kind into this product through openings as they may touch dangerous voltage points or short-out parts that could result in a fire or electric shock. Never spill liquid of any kind on the product.
17. **Servicing:** Do not attempt to service this product yourself as opening or removing covers may expose you to dangerous voltage or other hazards. Refer all servicing to qualified service personnel.
18. **Damage Requiring Service:** Unplug this product from the wall outlet and refer servicing to qualified service personnel under the following conditions:
  - (a) When the power-supply cord or plug is damaged.
  - (b) If liquid has been spilled, or objects have fallen into the product.
  - (c) If the product has been exposed to rain or water.
  - (d) If the product does not operate normally by following the operating instructions. Adjust only those controls that are covered by the operating instructions as an improper adjustment of other controls may result in damage and will often require extensive work by a qualified technician to restore the product to its normal operation.
  - (e) If the product has been dropped or damaged in any way.
  - (f) The product exhibits a distinct change in performance.
19. **Replacement Parts:** When replacement parts are required, be sure the service technician uses replacement parts specified by Scientific-Atlanta, or parts having the same operating characteristics as the original parts. Unauthorized part substitutions made may result in fire, electric shock or other hazards.
20. **Safety Check:** Upon completion of any service or repairs made to this product, ask the service technician to perform safety checks to determine that the product is in safe operating condition.
21. **Outdoor Antenna Grounding:** If an outside antenna or cable system is connected to this product, ensure that the antenna or cable system is properly grounded to provide protection against voltage surges and built-up static charges. Appropriate sections of the National Electrical Code (NFPA 1990) provide information with respect to proper grounding of the mast and supporting structure, grounding of the lead-in wire to an antenna discharge unit, connection to grounding electrodes, and requirements for the grounding electrode (see "...About receiver & satellite antenna grounding").

## ...About receiver & satellite antenna grounding

Before you can operate your Headend Satellite Receiver system, both the receiver chassis and the satellite antenna LNB connection(s) must be properly grounded. Information about grounding your receiver and satellite antenna follow.

### Grounding the receiver

The receiver ground connection is made from the shield<sup>1</sup> conductor attached to the RF coaxial cable "F" connector (rear panel SATELLITE input) to an external grounding rod via a receiver/antenna grounding block. A separate grounding wire connects the grounding block (and the satellite antenna LNB grounding block) to the grounding rod (see Figure 1).

### Grounding the LNB and/or VHF/UHF antenna

The antenna ground connection is made from the satellite LNB/antenna ground and/or the VHF/UHF terrestrial antenna discharge unit to an external grounding rod via a receiver/antenna grounding block.

### General grounding information

The actual ground/cable connections made depend on your site installation requirements, and on the type of satellite antenna and/or VHF/UHF terrestrial antenna you have. If your satellite antenna installation includes a dual-port LNB, both RF coaxial cables must be routed to the grounding block. When connecting RF coaxial antenna cables to the grounding block, looping the antenna cables as shown in the accompanying figure helps to direct moisture away from the grounding block. Always choose the shortest route possible when connecting RF coaxial cables to the receiver/antenna grounding block, and when connecting the grounding wire(s) to the grounding rod.

---

<sup>1</sup> Multi-strand (braided) shield that surrounds the center conductor of the coaxial cable

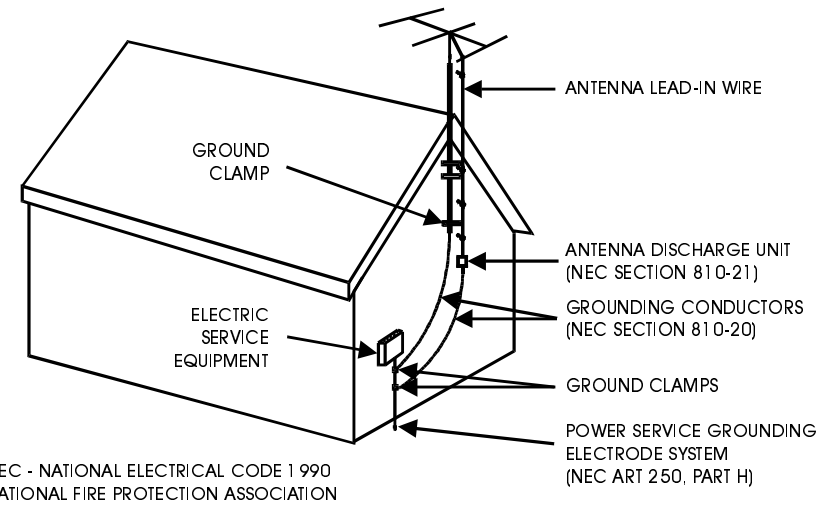

TO CATV SYSTEM INSTALLER

This reminder is provided to call the CATV system installer's attention to Article 820-40 of the National Electrical Code (NEC) that provides guidelines for proper grounding, and in particular, specifies that the cable ground shall be connected to the grounding system of the building, as close to the point of entry as practical.

Figure 1. Receiver & satellite antenna grounding

Ensure that all wires/cables are properly routed, and are clamped/secured, as required. Install the grounding rod as close to the grounding block as possible (NEC 820-40 [USA]). If your satellite antenna is installed on a separate support structure and/or is not located near the RF antenna cable point-of-entry, a duplicate ground using a second grounding rod installed as close to the antenna as possible is recommended. Typically, a good earth ground can be obtained by driving a grounding rod made of copper-clad iron into the ground next to the grounding block.



## IMPORTANT

Install this product on a flat surface only, ensuring that all four rubber feet are making full contact with the mounting surface. During normal operation, it is recommended that physical contact be limited to using the front panel buttons only. Do not place any other equipment directly on top of the receiver, and prevent foreign objects from coming into direct contact with the chassis. Subjecting this product to abnormal impact may result in momentary interruption of video service.

## NOTICE FOR CUSTOMERS IN THE UNITED KINGDOM

### WARNING THIS APPARATUS MUST BE EARTHED

#### AC MAINS LEAD CONNECTION (IMPORTANT)

The wires in this mains lead are coloured in accordance with the following code:

- Green-and-Yellow: Earth
- Blue: Neutral
- Brown: Live

As the colours of the wires in the mains lead of this apparatus may not correspond with coloured markings identifying the terminal in your plug, proceed as follows:

1. The wire which is coloured green-and-yellow must be connected to the terminal plug which is marked by the letter E, by the safety earth symbol (⏚) or coloured green-and-yellow.
2. The wire which is coloured blue must be connected to the terminal which is marked with the letter N or coloured black.
3. The wire which is coloured brown must be connected to the terminal which is marked with the letter L or coloured red.

## SAFETY PRECAUTIONS (EU Market)

## MESURES DE SÉCURITÉ

## SICHERHEITSMASSNAHMEN

## PRECAUCIONES DE SEGURIDAD

### WARNING

To prevent fire or electric shock:

- Do not expose this apparatus to rain or moisture.
- Avoid spilling liquids on or near this apparatus.
- Do not open the top cover of this apparatus.
- Do not push objects through openings in this apparatus.
- Refer servicing to qualified personnel only. Contact your cable operator for service.

### ATTENTION

Afin d'éviter tout incendie ou choc électrique:

- Ne laissez pas cet appareil sous la pluie ou dans un endroit humide.
- Ne renversez pas de liquide sur ou à proximité de l'appareil.
- N'ouvrez pas le couvercle supérieur de l'appareil.
- N'insérez pas d'objet dans les ouvertures de l'appareil.
- Faites réparer votre appareil par une personne qualifiée, contactez votre opérateur cable pour le service



## WARNUNG

Um Feuer oder elektrischen Schock zu vermeiden:

- ❑ Keiner Nässe oder Feuchtigkeit aussetzen.
- ❑ Keine Flüssigkeiten auf oder in der Nähe des Gerätes verschütten.
- ❑ Den oberen Deckel nicht öffnen.
- ❑ Keine Gegenstände in die Geräteöffnungen stecken.
- ❑ Arbeiten am Gerät nur von qualifiziertem Personal vornehmen lassen. Wenden sie sich an ihre Kabelfirma.

## ADVERTENCIA

Para prevenir incendio o una descarga eléctrica:

- ❑ No exponga este aparato a la lluvia o a la humedad.
- ❑ Evite derramar líquidos en o cerca del aparato.
- ❑ No abra la cubierta superior de este aparato.
- ❑ No introduzca objetos a través de las aberturas de este aparato.
- ❑ Mandelo a servicio únicamente donde existe personal calificado. Para servicio consulte con su operador de cable.

## CAUTION

- ❑ To protect this apparatus against damage from lightning storms and power-line surges, or when you are not using this apparatus for a long period of time, disconnect the power cord from the AC outlet.
- ❑ To disconnect the cord, pull it out by grasping the plug. Never pull the cord itself. Additionally, never walk on, place objects on, or pinch the power cord.
- ❑ The top cover on this apparatus has openings for ventilation to protect it from overheating. To ensure reliable operation, do not block or cover these openings by placing this apparatus on a bed, sofa, rug, or any similar surface, or by placing entertainment apparatus, lamps, books, or other objects on the top cover.

- ❑ Additionally, never place this apparatus near or over a radiator or heat register, or a built-in installation, such as a bookcase or rack, unless the installation provides proper ventilation.
- ❑ Locate this apparatus on a stable, vibration-free surface capable of supporting its weight and size.

## PRÉCAUTIONS À PRENDRE

- ❑ Afin de protéger votre appareil des orages et des surtensions de courant ou si vous ne l'utilisez pas pendant une période prolongée, débranchez de la prise électrique du secteur.
- ❑ Pour débrancher, tirez sur la prise. Ne tirez jamais sur le cordon secteur. En outre, ne marchez jamais sur le cordon, ne placez pas d'objet dessus et ne le coincez pas.
- ❑ Le couvercle supérieur de cet appareil comprend des ouvertures pour la ventilation afin d'éviter qu'il ne chauffe trop. Pour assurer un bon fonctionnement, ne bloquez pas ou ne couvrez pas ces ouvertures en plaçant cet appareil sur un lit, un sofa, un tapis ou toute autre surface semblable. Ne posez pas de lampes, livres ou tout autre objet sur le couvercle supérieur.
- ❑ De plus, il ne faut jamais mettre cet appareil près d'un radiateur ou tout autre élément dégageant de la chaleur. Ne l'incorporez pas dans une installation comme une bibliothèque, une étagère, à moins que l'installation offre une ventilation appropriée.
- ❑ Installez cet appareil sur une surface dégagée, stable et sans vibration capable de supporter son poids et sa taille.

## VORSICHT

- ❑ Um dieses Gerät vor Blitzschlag bzw. Stromüberladung zu schützen, oder wenn das Gerät längere Zeit nicht benutzt wird, soll der Stecker aus der Steckdose gezogen werden.
- ❑ Zum Abschalten immer am Stecker selbst und nie am Kabel ziehen. Außerdem nie darauf treten, einen Gegenstand darauf legen oder das Kabel drücken.

- ❑ Die Oberseite des Gerätes hat Ventilationsöffnungen, die das Gerät vor Überhitzung schützen. Um einwandfreies Funktionieren zu gewährleisten, dürfen diese Öffnungen nicht blockiert oder verdeckt werden (z. B. nicht auf ein Bett, Sofa, Teppich oder ähnliche Unterlagen stellen, oder Lampen, Bücher oder ähnliches auf das Gerät stellen).
- ❑ Außerdem soll dieses Gerät nie in der Nähe einer Heizquelle stehen. Vermeiden Sie, das Gerät in einem geschlossenen Platz aufzustellen, z. B. Schrank, wo ausreichende Ventilation nicht möglich ist.
- ❑ Stellen Sie das Gerät auf eine stabile und schwingungsfreie Unterlage, die für das Gerät groß genug ist.

## **PRECAUCION**

- ❑ Para proteger este aparato contra daños producidos por tormentas eléctricas y pulsaciones de energía eléctrica, o cuando no use este aparato por largo tiempo, desconéctelo del tomacorriente de CA.
- ❑ Para desconectar el cable, tómelo del enchufe y desconéctelo. Nunca tire del cable directamente. Asimismo, nunca apriete, pise, o coloque objetos sobre el cable.
- ❑ La cubierta superior de este aparato tiene aberturas de ventilación para evitar que se recaliente. Para asegurar una operación confiable, no bloquee o cubra estas aberturas colocando este aparato sobre una cama, sofá, alfombra o cualquier superficie similar, o colocando sobre la cubierta superior artefactos de entretenimiento, lámparas, libros u otros objetos.
- ❑ Adicionalmente, nunca coloque este aparato cerca o sobre una salida de calefacción o lo instale en un lugar tal como un mueble integrado o estante para libros, a menos que la instalación proporcione una ventilación adecuada.
- ❑ Coloque este aparato sobre una superficie estable, sin vibraciones y que tenga la capacidad de aguantar su peso y tamaño.

# Table of contents

IMPORTANT SAFEGUARDS.....	i	...About Lock Levels.....	10
...About receiver & satellite antenna grounding.....	iii	...About Signal Searches.....	11
Grounding the receiver.....	iii		
Grounding the LNB and/or VHF/UHF antenna.....	iii		
General grounding information.....	iii		
SAFETY PRECAUTIONS (EU Market).....	iv		
<b>Introduction.....</b>	<b>1</b>	<b>Alt Mode operation.....</b>	<b>12</b>
...About this guide.....	1	...About Alt Modes.....	12
Your Headend Satellite Receiver.....	1	...About frequency settings.....	13
Unpacking your receiver.....	1	...About changing the Symbol Rate.....	14
Before you get started.....	1	AFC Level.....	15
Connecting your system.....	2	Alt-1 Mode.....	15
...About the EXPANSION port.....	2	Alt-2 Mode.....	15
TV & RF plus optional connections.....	3	Aspect Ratio.....	15
		Baud Rate.....	16
<b>Operating the receiver.....</b>	<b>4</b>	FEC Rate.....	16
Front panel controls & display.....	4	Band Select.....	16
STANDBY button.....	4	Crossover frequency.....	17
MENU button.....	4	Factory Reset.....	17
SIGNAL indicator LED.....	4	Frequency.....	17
ALT Mode indicator LED.....	4	Frequency Mode.....	18
7-Segment display.....	4	Lock Level.....	18
MULTI-FUNCTION keypad.....	5	LO Frequency #1.....	19
NUMERIC keypad.....	5	LO Frequency #2.....	19
SMART CARD slot.....	5	Signal Quality.....	20
CHANGING channels.....	5	Signal Polarization.....	20
CHANGING the volume.....	5	Signal Search.....	20
Menus at-a-glance.....	6	Signal Strength.....	21
		Symbol Rate.....	21
		View.....	22
<b>Setting up the receiver.....</b>	<b>7</b>	<b>On-screen menu operation.....</b>	<b>23</b>
...About the Alternate Mode interface.....	7	...About on-screen menu operation.....	23
...About operating the on-screen menus.....	7	Receiver Setup menu.....	24
...About entering numbers using front panel buttons.....	8	...About frequency settings.....	24
...About saving changes.....	8	...About the Signal State.....	27
...About the current channel.....	9	...About the Find option.....	27
...About changing the Video Standard.....	9	User Setup menu.....	29
...About the Network ID.....	10	...About Lock Levels.....	29
...About the Password.....	10	...About the Aspect Ratio.....	30
		...About the local time.....	30
		...About video subtitles.....	31

...About the Password.....	32
...About factory defaults.....	32
...About the IR Remote Control.....	33
Search Setup menu.....	34
...About the Search option.....	34
...About other Search Setup options.....	35
...About I/Q signal inversion.....	36
Receiver Status menu.....	37
...About the ADP count.....	37
Available Services menu.....	39
...About subscriber services.....	39
...About the current channel.....	40
Dish Pointing menu.....	41
...About Signal Strength and Signal Quality.....	41
Configuration menu.....	42
Network Presets menu.....	44
...General rules for using the Network Presets menu.....	44
...About the Signal State.....	47
Display Setup menu.....	48

**Appendix A Specifications ..... A-1**

**Appendix B Troubleshooting ..... B-1**

Troubleshooting checklist.....	B-1
Questions and answers.....	B-3

**Appendix C Serial Remote Control Command Set ..... C-1**

Command protocol.....	C-1
Command/Response messaging.....	C-1
Error responses.....	C-2
Bit Error Rate (BER).....	C-2
Channel.....	C-2
Errors (Corrected).....	C-3
Errors (Uncorrected).....	C-3
External Security microprocessor.....	C-3
Frequency Stability (AFC level).....	C-3
Installer.....	C-4
Internal Security microprocessor.....	C-4
Keypad microprocessor.....	C-4
Lock Level.....	C-5
Main microprocessor.....	C-5
Port Control.....	C-5

Power.....	C-5
Reset.....	C-6
Signal Quality.....	C-6
Signal State.....	C-6
Signal Strength (AGC level).....	C-6
Version.....	C-7

**Appendix D Customer information ..... D-1**

Product support.....	D-1
Hotline technical support.....	D-2
Training support.....	D-2
Warranty and post-warranty support.....	D-2
Customer responsibility.....	D-2
In case of a fault.....	D-2
Product return.....	D-3
Limited Warranty.....	D-4
Warranty terms and conditions.....	D-4
Limits of liability.....	D-4
Disclaimer.....	D-4
FCC notices.....	D-5
Industry Canada notice.....	D-5

**Appendix E Product identification ..... E-1**

---

# Introduction

## ...About this guide

This Installation and Operation Guide includes all the information you'll need to install and begin using your Scientific-Atlanta PowerVu Headend Satellite Receiver. Use it to familiarize yourself with product features and operation, and for quick reference when needed. The guide provides complete operating instructions and other important information about your Headend Satellite Receiver. We recommend that you read this guide before you begin using the receiver.

## Your Headend Satellite Receiver

Welcome to the world of PowerVu direct-broadcast satellite services. Your Headend Satellite Receiver provides the ultimate in digital-quality video, audio and data services. Designed using state-of-the-art MPEG 2 digital compression and broadcast satellite technology, your PowerVu Model D9225 Headend Satellite Receiver is quality-built for trouble-free operation, and comes equipped with many built-in features and capabilities. Depending on the country or jurisdiction where it is used, your Headend Satellite Receiver may be slightly different from other models.

- MPEG 2/DVB digital video and audio signals in 525-line or 625-line systems
- Variable symbol rates from 3.0 to 30.8 Msymbols/s
- Single or multiple channel per carrier within the same unit
- Smart Card receptacle for field-upgradable security
- Selectable Viterbi Forward Error Correction rates of  $\frac{1}{2}$ ,  $\frac{2}{3}$ ,  $\frac{3}{4}$ ,  $\frac{5}{6}$  or  $\frac{7}{8}$  (installer-selectable or downloadable over satellite)
- Low-Speed data output and rates up to 38.4kbits/s via EXPANSION PORT
- Left and right balanced and unbalanced audio outputs
- Multilingual subtitles
- reinsertion of NABST, AMOL I AND II (Nielsen), and WST data
- Cue tone equivalent signalling information and control
- LNB power ON/OFF switch
- 24 independent user-configurable Network Presets

## Unpacking your receiver

Before you proceed with unpacking the equipment, inspect the shipping carton for damage. If damage is apparent, do not proceed with unpacking and report the damage immediately to the shipper or your retailer. If there is no apparent damage, remove the contents from the carton and protective packaging. Retain the packaging in the event of return, or for equipment storage.

## Before you get started

Before proceeding, check that your Headend Satellite Receiver is correctly installed as part of your Video/Audio system. Before you can operate the receiver, it must be properly connected to your satellite LNB antenna, TV monitor and to other A/V equipment, as required. For information about installing and connecting the receiver, refer to this guide. If you need assistance with the installation of your Headend Satellite Receiver or satellite antenna, or with connecting or modifying your equipment installation, contact your dealer/reseller or local service provider for assistance. For product identification and other/servicing information, see the Appendices.

# Connecting your system

The following information is provided to help you set up and connect the Headend Satellite Receiver to the satellite antenna, TV monitor, and other A/V (Audio/Video) headend equipment. The accompanying figure shows receiver rear panel connections for the NTSC receivers base version. For equipment interconnection details, see "TV & RF plus optional connections".

## ...About the EXPANSION port

The Headend Satellite Receiver can be operated and monitored remotely via the EXPANSION port when connected to a PC workstation or data terminal. Remote receiver operation requires installation of a PC/data communications program. Note that certain program settings may vary, depending on the type of workstation/terminal equipment being used. Data interface cables connected between the Headend Satellite Receiver and some customer equipment may require a unique pin-out for proper operation via the EXPANSION port (DB-25 female connector). For port pin-out information, see the accompanying table. Note that only those EXPANSION port pins used are shown (i.e., all other pins are unused, or are not required for normal operation).

Table1. EXPANSION port pin-out

Pin	Function
#1	Chassis Ground
#2	Low Speed Data (up to 38.4 Kbps)
#7	Signal Ground
#12	Remote Rx (input)
#13	Remote Tx (output)
#20	+5 VDC control output via 1K $\Omega$ pull-up resistor
#21	+5 VDC control output via 47 $\Omega$ pull-up resistor
#22	Control output #4
#23	Control output #3
#24	Control output #2
#25	Control output #1

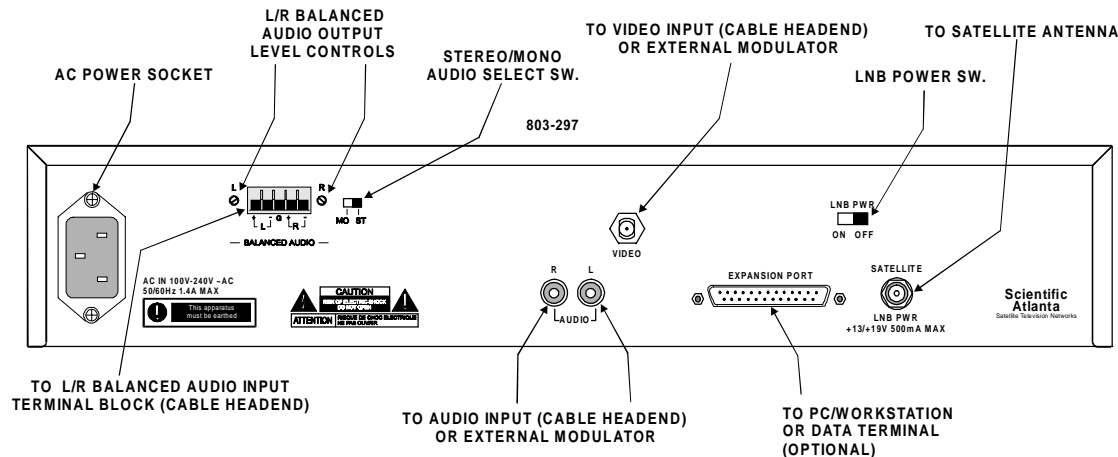

Figure2. Rear panel connections

## TV & RF plus optional connections

The accompanying figure shows the cable connections required for the satellite LNB and TV monitor plus other (optional) connections that can be made from the rear panel of your Headend Satellite Receiver. As many different equipment configurations are possible, use the following information as a guide only. If you need assistance to identify your specific equipment configuration needs, contact your dealer/reseller or local service provider (see also “Connecting your system”).

### Satellite antenna LNB and TV monitor connection...

- ❑ Connect the coaxial RF cable from the satellite antenna LNB to the receiver SATELLITE jack
- ❑ Connect a coaxial cable from the receiver VIDEO output jack to the TV monitor VIDEO IN jack (optional), or to external headend TV modulator equipment

### LNB power supply switch setting...

- ❑ Set the satellite LNB power switch (near SATELLITE connector) to OFF for using the external LNB power source, or to ON for using the internal receiver LNB power source (LNB power switch set to ON permits software control over the LNB power supply output voltage from the receiver if switchable LNB connected)

### Audio connections & level control...

- ❑ **Unbalanced AUDIO:** Connect A/V cables from the L (Left) and R (Right) receiver AUDIO output jacks to the AUDIO IN jacks of your headend A/V equipment (optional)
- ❑ **Balanced Audio:** Connect separate conductors from the L (Left, +/-) and R (Right +/-) receiver balanced audio output terminals plus the G (Ground) terminal to the balanced audio/ground terminals of your headend A/V equipment
- ❑ **Level Control (Balanced Audio):** If necessary, change the Left and Right preset audio channel signal levels higher or lower (i.e., from unity gain) adjustable  $\pm 6$  dB by rotating the potentiometers marked L and R (across from balanced audio output terminals) clockwise or counterclockwise, respectively

### Stereo/Mono balanced audio output switch setting...

- ❑ Set the MO/ST slide switch (near balanced audio output level control) to MO for monaural audio output, or to ST for stereo audio output to your headend A/V equipment

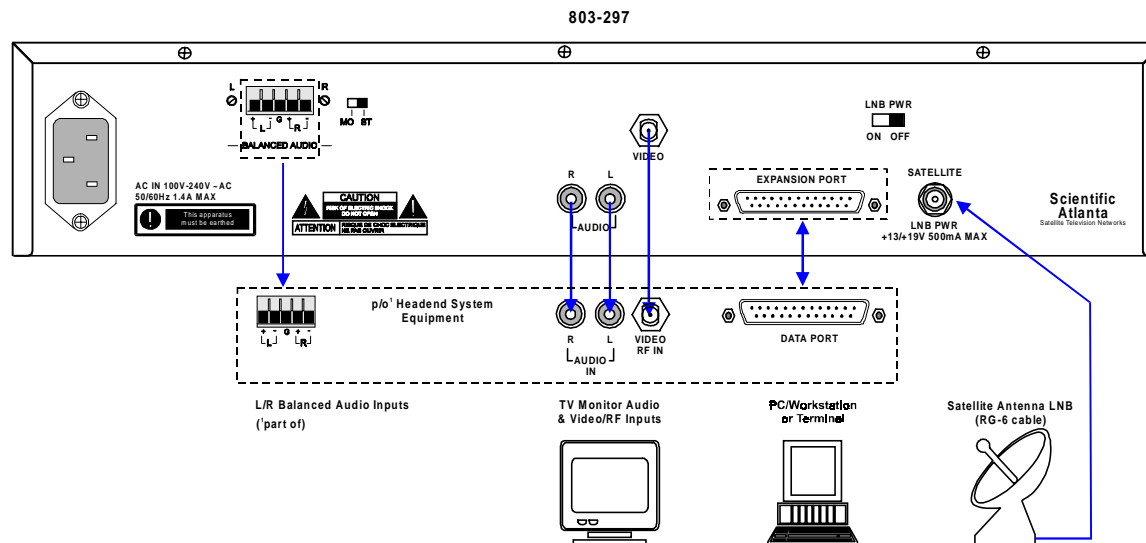

Figure 3. TV & RF plus optional connections

# Operating the receiver

This Installation and Operation Guide provides all the information you need to setup and operate your PowerVu Headend Satellite Receiver.

## Front panel controls & display

The front panel of your Headend Satellite Receiver provides controls for switching the receiver on and off, switching the receiver to Alt Mode operation, activating and navigating menus, and for interfacing with the Smart Card. A Signal presence LED and an Alternate Mode indicator LED are provided. A 4 digit, 7-segment LED display provides visual identification of current receiver settings, and also provides user feedback when changing the current receiver setup via the front panel. An introduction to each of the front panel buttons and indicators follows.

### STANDBY button

The STANDBY button switches the Headend Satellite Receiver on and off (standby).

To switch the receiver on or off from the front panel...

Press **STANDBY** .....



When the receiver is switched on, the front panel LED display is ON. When switched off (standby), all indicator and display LEDs are OFF, and a single dot flashes ON and OFF, repeatedly.

### MENU button

While viewing any channel you can use the MENU button (front panel) to display the **Main Menu**.

To display the Main Menu...

Press **MENU** .....

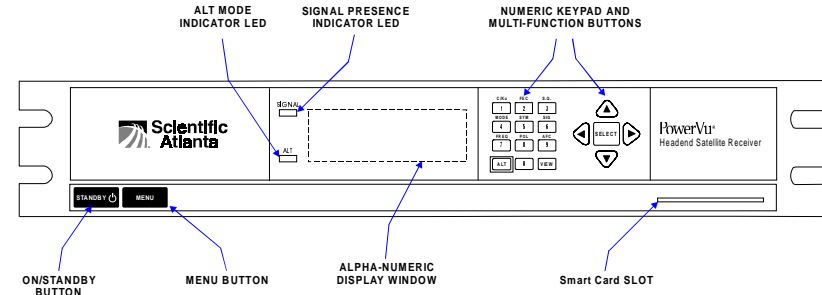

Figure 4. Front panel controls and display

### SIGNAL indicator LED

The Signal indicator LED is ON when your Headend Satellite Receiver is synchronized with the incoming digital video signal. If no incoming signal is detected or recognized by the receiver, or if the receiver setup is incorrect, this LED is OFF. If the incoming signal or signal synchronization is temporarily interrupted or lost, this LED may turn OFF or may flicker (i.e., turn ON and OFF intermittently). Also, if the receiver is not authorized to receive programming via the local service provider, the SIGNAL LED flashes ON and OFF (i.e., ON and OFF). For more information about troubleshooting your Headend Satellite Receiver, see “Appendix B Troubleshooting”.

### ALT Mode indicator LED

The ALT Mode indicator LED flashes ON and OFF when your Commercial Satellite Receiver is operating in Alt-1 Mode, and is ON when operating in Alt-2 Mode. When operating the receiver in Alt Mode, you can use the front panel keypad Alt Mode functions to change the current receiver setup. When the receiver is in normal operating mode, this LED is OFF. For information about using Alt Mode functions to operate your Headend Satellite Receiver, see “Setting up the receiver”.

### 7-Segment display

Visual identification of current receiver settings is provided by a 4 digit, 7-segment LED display. The display provides you with immediate feedback when making changes to the current receiver setup via the front panel buttons. When the receiver is switched on, the 7-segment display shows the current channel.



## MULTI-FUNCTION keypad

The multi-function keypad includes the **↑**, **↓**, **←** and **→** arrow buttons and the **SELECT** button. Use the arrow buttons and the **SELECT** button to operate the on-screen menus. The arrow buttons are found on the receiver front panel together with the **SELECT** button. You use the **SELECT** button separately to make selections from on-screen menus, and together with the arrow buttons to perform special functions (see also “Front panel controls & display”).

While viewing any channel you can use the **↑/↓** arrow buttons to display (higher or lower) channels, and the **←/→** arrow buttons to increase or decrease the volume level, respectively. Note that **↑/↓** arrow buttons control available channels only (see also “CHANGING channels” and “CHANGING the volume”).

To use the arrow buttons and the **SELECT** button...



## NUMERIC keypad

While viewing any channel you can use the front panel buttons to change the current receiver setup by switching from normal receiver operation to one of two (2) alternate operating modes (i.e., Alt Mode-1 and Alt Mode-2). For more information about Alt Modes, see “Setting up the receiver”.

While in normal operating mode (i.e., front panel ALT LED OFF), you can use the front panel numeric keypad to change any channel from 001 through 999, or to enter information for menu options (see “Setting up the receiver”).

To use the numeric keypad (normal mode operation)...



To use the numeric keypad (Alt Mode operation)...

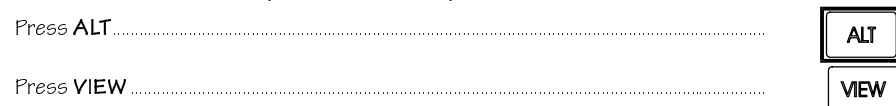

Use the **VIEW** button to return to normal receiver operation from Alt Mode. Other Alt Mode functions are also available via the front panel. For complete information about viewing or changing the current receiver setup using Alt Mode functions, see “Alt Mode operation”.

## SMART CARD slot

Security and/or preauthorized satellite broadcast services upgrades via Smart Card are planned in future for the PowerVu Headend Satellite Receiver.

## CHANGING channels

While viewing any channel you can change channels (higher or lower) one channel at a time. Channels are changed (higher or lower) depending on which button is pressed.

To change channels...

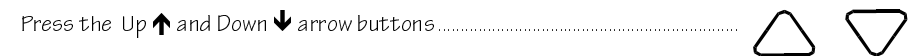

Channels can also be changed directly by pressing the numbered front panel buttons (e.g., to change to channel 5, press 0005, or press 5 and then **SELECT**).

## CHANGING the volume

While viewing any channel you can increase or decrease the volume level. The volume level is increased or decreased depending on which button is pressed.

To change the volume...

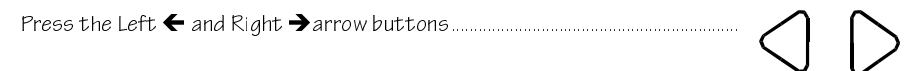

# Menus at-a-glance

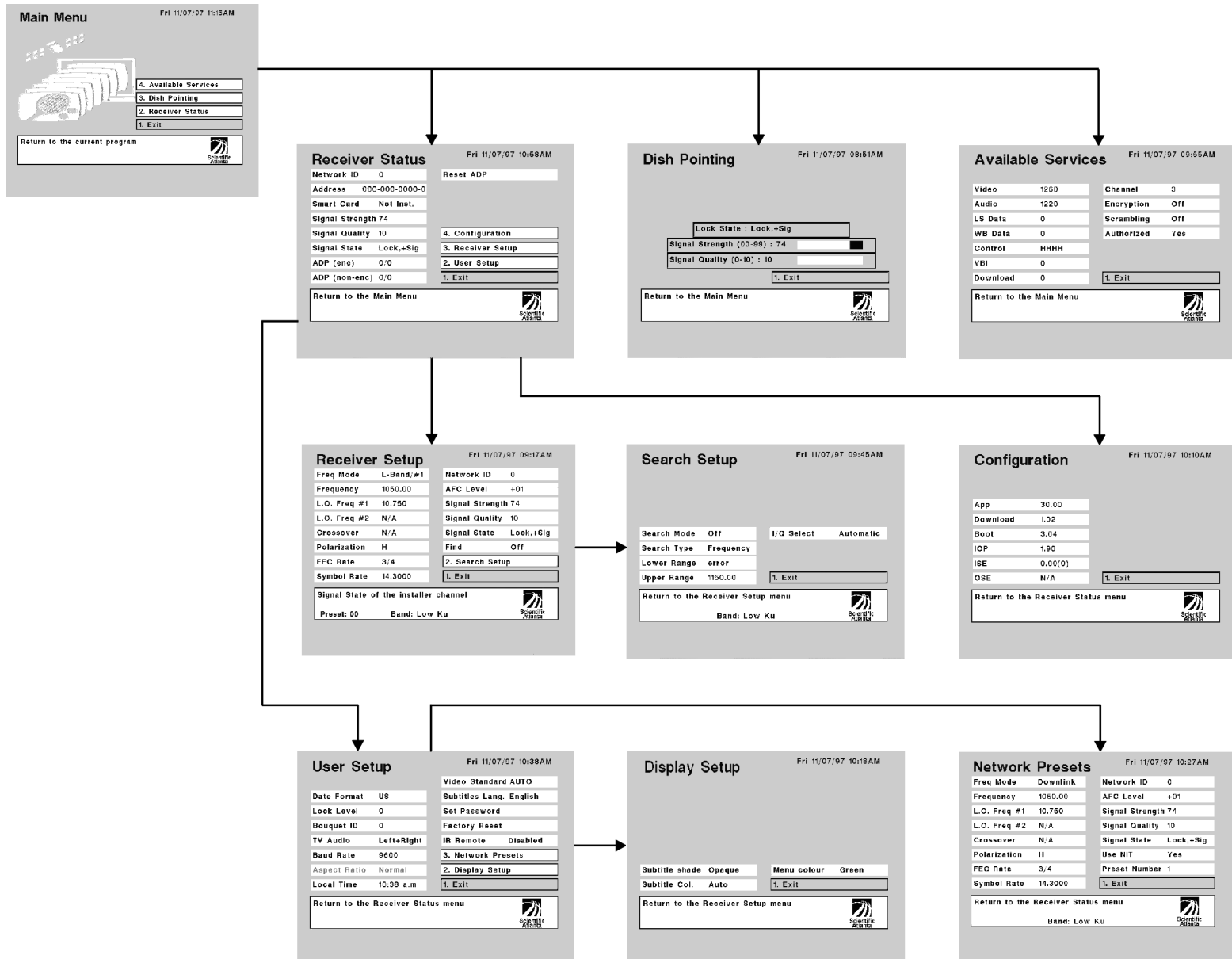

Figure5. Menus at-a-glance

# Setting up the receiver

This section provides important operating information regarding the setup and operation of your PowerVu Headend Satellite Receiver and satellite antenna signal source, including signal search. Before you begin using the receiver, it is important that you read all of the information in this section first. If you are modifying your receiver or system configuration, you may need to change the current settings to suit your operating requirements.



**IMPORTANT!** Access to your PowerVu Headend Satellite Receiver setup can be Password-protected. Depending on the current Lock Level setting, you may be prompted for the Password before you can display on-screen menus, or before using the Alt Mode front panel interface. Note that if Lock Level 3 is currently set, pressing any button displays a password prompt (see "...About the Password").

Because some or all of the receiver setup can be Password-protected, you may or may not be permitted to make changes to the current settings.

## Using the receiver front panel buttons you can...

- Activate and navigate the on-screen menus via the menu interface
- Operate the receiver in Alt Mode via the Alt Mode interface
- View or change the current receiver setup
- Select and view available satellite programs or events

Both the menu interface and the Alt Mode interface can be used interchangeably for performing most receiver setup tasks, since both are operated via receiver operating system software. However, not all menu interface functions are duplicated by the Alt Mode interface. Depending on how you have installed and connected the Headend Satellite Receiver, you may or may not be able to use the menu interface. If the receiver is connected to a TV/video display monitor, you can view or change the current receiver setup via on-screen menus. Conversely, if no TV/video display monitor connection is available, only the front panel Alt Mode interface can be used for receiver setup, and you will not need to reference instructions provided for operating the various menus.

## ...About the Alternate Mode interface

While viewing any channel, you can use Alt Mode functions to view the current receiver setup, or you can view or change the current setup from the Installer Channel. Alt Mode functions are available via receiver front panel buttons. Alt-1 function labels are printed directly on the keypad bezel above each button (see Figure 4). Alt-2 functions are also associated with front panel buttons, except that the function names are not printed on the keypad bezel (see "...About entering numbers using front panel buttons"). As with the menu interface, access to Alt Mode functions is controlled by system Lock Levels and the security Password. More information about Lock Levels and the Password is contained in this section.

For detailed information about how each of the Alt-1 and Alt-2 functions are used to set up the receiver, see "Alt Mode operation".

## ...About operating the on-screen menus

While viewing any channel, you can display on-screen menus for viewing or changing the current receiver setup. While in menus, you can change the current receiver settings, and/or display other menus. Some menus contain setup information which is available for viewing only, and cannot be changed. Numbered menu options are used to display other menus. Access to menus and changeable menu options is controlled by system Lock Levels and a security Password. For more information about Lock Levels and the Password, see "...About the Password".

### To display on-screen menus...

- Press the **MENU** button on the receiver front panel.

### To change a receiver setting...

- Step 1.** Move to the desired setting using the **↑**, **↓**, **←** and **→** arrow buttons.
- Step 2.** For numeric entry options, press **SELECT** to clear the display field, enter the number and then press **SELECT** again. For all other options, press **SELECT** repeatedly to display available settings.

**Step 3.** After making changes, move to Exit and press SELECT, or press 1 and then press SELECT. This action displays the Save pop-up menu.

**Step 4.** Press 1 to save the new configuration.

#### To display another menu, or exit from the current menu...

**Step 1.** Move to the desired menu option using the **↑**, **↓**, **←** and **→** arrow buttons and press SELECT, or...  
Press the number displayed at the menu option (left) and then press SELECT.

When you select EXIT or if you press the MENU button after making changes, a pop-up menu displays available Save options (see "...About saving changes").

#### To display the Main Menu (if Lock Level 3 set)...

**Step 1.** Press the MENU button.  
An on-screen prompt displays for entering the current Password.

**Step 2.** Enter the current Password and press SELECT to display the Main Menu (for security, a default character is substituted for each number pressed).

For more information about the Password, see "...About the Password".

## ...About entering numbers using front panel buttons

**Alt Mode interface:** The Alt Mode interface cannot be used for direct numeric entry. Some Alt Mode options let you enter values directly using front panel buttons. To operate the front panel for setting numeric functions while in Alt Mode, perform the following actions.

**Step 1.** Change to Alt-1 or Alt-2 Mode operation by pressing the ALT button on the receiver front panel (see "Alt Mode operation").

**Step 2.** Press the **↑** or **↓** arrow button to change the currently displayed value higher or lower, as required, and then press SELECT.

Each change made must be saved before exiting (see "...About saving changes"). Pressing the **↑** or **↓** arrow button displays available options (numbers) in fixed steps. Note that stepping speed increases if you press and hold down the arrow button.

If the selected value is out of range or conflicts with another setting, a pop-up message displays information about the error, or substituted (default) value. For a list of frequency-related error messages, see Table 6.

**Menu interface:** Some menu options let you enter values directly using front panel buttons. To enter numbers directly and to operate numeric functions, perform the following actions.

**Step 1.** Press SELECT (after moving to the desired option) to replace the current setting. This action also clears the display field.

**Step 2.** Press the front panel buttons to enter the number.  
Each number entered is displayed on-screen (decimal places may also display automatically). If you make a mistake while entering numbers, press the **←** or **→** arrow button to clear the entry and start again.

**Step 3.** Press SELECT after completing the numeric entry.

Changes made must be saved before exiting (see "...About saving changes"). If you press SELECT to clear the entry, pressing the **↑** or **↓** arrow button displays available options (numbers) in fixed steps.

Repeat this action to change the current setting. If a value entered is out of range or conflicts with another setting, a pop-up message displays information about the error, or substituted (default) value. For a list of frequency-related error messages, see Table 6.

## ...About saving changes

**Alt Mode interface:** After making changes to the current setup via any Alt Mode function, you must save or discard the changes. Saved changes are used to update the current receiver settings which are stored in non-volatile memory. Discarding changes restores the previously saved settings. You can also cancel the operation to make further changes. For more information about Alt Modes, see "Alt Mode operation".

When you press the ALT, VIEW or STANDBY button after making changes, "sav?" is displayed at the front panel (see Figure 4).

### After changing the current receiver setup you can...

- ❑ **Save:** Press 1 to save the new settings (done)
- ❑ **Restore:** Press 2 to discard all changes (rstr)
- ❑ **Cancel:** Press 3 to cancel the operation (abrt)

**Menu interface:** After making changes to current receiver setup, you must save or discard changes. Saved changes are used to update the current receiver settings which are stored in non-volatile memory. Discarding changes restores the previously saved settings. You can also cancel the operation to make further changes. For more information about menus, see “On-screen menu operation”.

When you select EXIT, or if you press the MENU, VIEW or SELECT button after making changes, a pop-up menu displays available Save options (see Figure 4). After changes are saved, you are automatically returned to the previous menu.

### After changing the current receiver setup you can...

- ❑ **Save:** Press 1 to save the new settings (YES)
- ❑ **Restore:** Press 2 to discard all changes (NO)
- ❑ **Cancel:** Press 3 to cancel the operation (CANCEL)

You can also perform these menu functions using the following front panel buttons.

- ❑ **Save:** Press and hold down both the ← and → arrow buttons simultaneously to save the new configuration (YES)
- ❑ **Discard:** Press and hold down both the ↑ and ↓ arrow buttons simultaneously to discard all changes (NO)
- ❑ **Cancel:** Press SELECT to cancel the operation (CANCEL)



**WARNING!** Saved settings are automatically restored when the receiver is restarted after AC power is switched off or interrupted. Upon restarting, the receiver defaults to the virtual channel previously displayed for more than 20 seconds after exiting from menus (see also “...About Lock Levels”).

## ...About the current channel

When you change from normal receiver operation to Alt Mode (or navigate to menus from video), the information displayed is associated with the current (virtual) channel. If no changes are made to the current setup, you are automatically returned to the previously-watched channel when you exit to video. If any changes are made which affect the received digital signal, exiting to video after saving changes is preceded by the Installer Channel banner display (i.e., channel 0). The current channel is displayed on-screen when in video, at the front panel when using the Alt Mode interface, and at the Available Services menu. For more information about the Installer Channel, see “Alt Mode operation”.



**IMPORTANT!** Exiting to video from menus after saving changes made to the current setup at the Receiver Setup menu only may be preceded by the Installer Channel banner display. The Installer Channel is a reserved channel associated with the current setup, and is usually channel “0”. Most receiver settings can only be changed from this channel. You can return to video programming from the Installer Channel by pressing the CH ↑/↓ or the Up /Down ↑/↓ multi-function buttons, or you can change channels directly using numbered front panel buttons.

## ...About changing the Video Standard

The Video Standard used to operate the receiver is preset at the factory to either NTSC (525-line), or PAL (625-line), depending on factory-installed options (if the receiver is equipped with a TV modulator, the compatible Video Standard is set as the factory default). Changing the Video Standard is normally required only for operating the receiver in a network or jurisdiction that uses the alternate Video Standard, and/or when new (or different) subscriber services are made available.

Changing the Video Standard or resetting the receiver to the default factory settings may cause the TV video to display improperly. If the current Video Standard setting is incompatible with subscriber/network services, it must be changed. For information about factory default settings, see “User Setup menu”.

## ...About the Network ID

Operating the Headend Satellite Receiver in a DVB<sup>1</sup> network requires a valid Network ID. This number must be correctly set to match the Network ID associated with the uplink signal. Loss of service will result if the receiver Network ID does not match the uplink signal Network ID information. If you are unsure about which Network ID to use, contact your dealer/reseller or local service provider.

The Network ID used to operate the receiver is preset at the factory (i.e., to 1). Changing the Network ID or resetting the receiver to the factory default settings may cause loss of service. If the Network ID required for your uplink service is unknown or is incorrect, it must be correctly identified and set. For information about factory default settings, see "User Setup menu".



**IMPORTANT!** The current Video Standard setting is used by the receiver for correct display of the video (picture) only. The satellite receiver does not convert from one Video Standard to another, such as from NTSC (525-line) to PAL-B (625-line).

## ...About the Password

A unique Password (4-digit number) protects the current receiver settings against unauthorized changes. When changing the Password, record and keep this number in a secure location. The default password provided is...

Default Password	1234
------------------	------

It is recommended that you change the default Password to a different Password when the receiver is first installed, and periodically afterward, as required. If the Password is lost or is unknown, contact your dealer/reseller or local service provider for assistance.

## ...About Lock Levels

Four (4) user-selectable Lock Levels are available for protecting your Headend Satellite Receiver and the current receiver settings against unauthorized use or modification (see Table 2). A Lock Level 0 setting lets you make any changes to the current receiver setup. Lock Levels 1 and 2 settings limit access to settings that cannot compromise the video signal. A Lock Level 3 setting prevents any changes to the current receiver setup by blocking access to menus or to the front panel (i.e., Alt Mode). A Lock Level 4 setting can only be changed via remote terminal (Serial Remote Control commands) or PCC uplink signal, and displays N/A (Not Applicable) if set. When the receiver configuration is protected via Lock Levels 3 or 4, menus cannot be displayed. Note that after setting the Lock Level to 3 and saving changes (menus only), exiting from the User Setup menu automatically returns you to video.



**IMPORTANT!** For Alt Mode operation only: The Lock Level setting can be changed from any channel, including the Installer Channel (i.e., channel 0). To return to the previously-watched (virtual) channel after changing the Lock Level setting to 3 in Alt Mode, be sure that the desired virtual channel is displayed before changing the Lock Level setting.

If an incorrect Password is entered at the Password prompt, a message displays to confirm the invalid Password, and access to the menu or option is denied. If a change made to the current Lock Level setting is not saved, the previously-saved setting is restored. The accompanying table summarizes Lock Level settings and associated receiver options.

**Menu interface:** When an attempt is made to change the current Lock Level setting (if set to Level 1, 2 or 3), a Password prompt displays. After the correct Password is entered, the Lock Level setting is automatically reset to Level 0. Similarly, the correct Password is also required before changing the Lock Level setting from Level 0 to Level 1 or higher. If no password is entered (Lock Level 3 is set), or if no other button is pressed within one (1) minute of the banner/prompt display, the current virtual channel displays automatically.

**Alt Mode interface:** The Alt Mode interface operates like the menu interface when changing the Lock Level settings, except that the current Lock Level setting can be changed higher or lower without being first reset to Level 0. The Lock Level setting

---

<sup>1</sup> Digital Video Broadcasting

is only reset to Level 0 after the correct Password is entered (Lock Level 3 is set). In addition, the Password prompt displays after the Lock Level setting is changed.

Table 2. Available Lock Levels

Level	Description
0	All settings unlocked (receiver lockout disabled)
1	All settings unlocked except Factory Reset and Password options
2	All settings unlocked except Receiver Setup and User Setup <sup>1</sup> options
3	All settings locked (access via Password only)
4	All settings locked (access via remote terminal or PCC uplink signal only)

## ...About Signal Searches

Searching for a signal with the “Search” option is used for restoring normal receiver operation if the received signal is interrupted or lost, or is changed by the local broadcast satellite services provider.

A signal search is enabled by setting the Search option to ON, and is activated automatically only if the carrier signal is interrupted or lost for more than 20 seconds, and only if the receiver is operating in normal mode (i.e., menus are not displayed). If the lost carrier signal is recovered within 20 seconds, the receiver will attempt to synchronize with the last locked channel. If unavailable, the “NO CHANNEL” banner is displayed. If the lost carrier signal is not recovered within this time, a signal search is activated automatically.

Once activated, the receiver begins searching for a signal associated with the current Network ID. When a possible match is found, the search is temporarily interrupted while the receiver attempts to synchronize with the found signal. If synchronization is successful, the signal status is displayed on-screen. Settings can be saved, as required, before exiting to video (current channel). If receiver synchronization cannot take place, the signal is discarded and the signal search is automatically resumed. If no signal is found, the signal search continues indefinitely, and must be manually terminated. A signal search can also be manually terminated, or interrupted and resumed with different settings. To disable the search, set the Search to OFF. A search is also terminated automatically if the current channel is changed, or if the MENU button is pressed.

Signal Searches are constrained or limited by the current Search Type and the boundary settings for the Lower and Upper Range frequencies. Default Search Type, Lower Range and Upper Range (frequency) criteria used for conducting the Signal Search can only be changed via the menu interface. For information about factory default settings, see “User Setup menu”.

---

<sup>1</sup> Baud Rate and TV Audio options are unlocked

# Alt Mode operation

Setting up your Headend Satellite Receiver via the Alt Mode interface requires setup of frequency-related and other options. These settings are used by the receiver for locking onto the signal, and for optimizing receiver performance. Some menu interface functions are also available via the Alt Mode interface. For a summary of Alt Mode functions, see Table 4.

## ...About Alt Modes

While viewing any channel, you can use Alt Mode functions to view the current receiver setup, or you can view or change the current setup from the Installer Channel. Alt Mode functions are available via receiver front panel buttons. Alt-1 function labels are printed directly on the keypad bezel above each button (see Figure 4). Alt-2 functions are also associated with front panel buttons, except that the function names are not printed on the keypad bezel (see “...About entering numbers using front panel buttons”). As with the menu interface, access to Alt Mode functions is controlled by system Lock Levels and the security Password. More information about Lock Levels and the Password is contained in this section.

Complete information about how each of the Alt-1 and Alt-2 functions are used to set up the receiver is contained in this section.

### To operate the receiver in Alt-1 Mode...

**Step 1.** Press the ALT button on the receiver front panel once. If you are already operating in Alt-2 Mode, press the ALT button twice.  
The ALT LED flashes to confirm Alt-1 Mode operation.

While the receiver is operating in Alt-1 Mode, the ALT LED flashes ON and OFF, and only Alt-1 functions are available via front panel buttons. Pressing ALT twice (or pressing VIEW) returns the receiver to normal operation (i.e., the ALT LED is OFF).

### To operate the receiver in Alt-2 Mode...

**Step 1.** Press the ALT button on the receiver front panel twice. If you are already operating in Alt-1 Mode, press the ALT button once.  
The ALT LED is ON to confirm Alt-2 Mode operation.

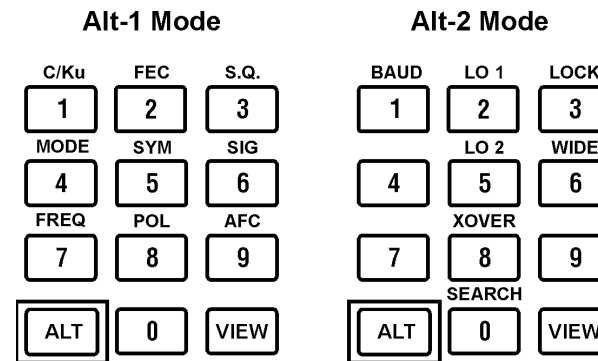

Figure 6. Front panel Alt-1 and Alt-2 Mode function buttons

While the receiver is operating in Alt-2 Mode, the ALT LED is ON, and only Alt-2 functions are available. Pressing ALT once (or pressing VIEW) returns the receiver to normal operation (i.e., the ALT LED is OFF).

### To change a receiver setting (Alt Mode)...

- Step 1.** Choose the desired Alt Mode function by pressing the appropriate front panel button.  
The current setting is displayed on the receiver front panel.
- Step 2.** For some Alt Mode functions, you press the same button repeatedly to display available options. For other functions, you press the  $\uparrow$  and  $\downarrow$  multi-function arrow buttons.
- Step 3.** Press SELECT after displaying the desired option.

### After changing a receiver setting you can...

- Save:** Press 1 to save the new settings (donE)
- Restore:** Press 2 to discard all changes (rstr)
- Cancel:** Press 3 to cancel the operation (abrt)



To exit from Alt Mode interface to video...

**Step 1.** Press the VIEW button  
(you can also press the ALT button until the ALT LED is OFF).

Table 4 provides a summary of available Alt Mode functions.

## ...About frequency settings

As you make changes to the current setup, the receiver checks that the Local Oscillator frequencies, Crossover frequency, Frequency and Frequency Mode settings are compatible with each other. A Crossover frequency is required only if you are using both Local Oscillators (i.e., you have a dual-band LNB). If used, the Local Oscillator Frequency #2 must be greater than Local Oscillator Frequency #1. The operating Frequency, Local Oscillator frequencies plus the Crossover frequency must be correctly set as specified by your antenna/LNB manufacturer, dealer/reseller or local service provider. The Frequency setting plus other settings used depend on subscriber/network services available, and may vary.

The relationships between the Downlink frequency, the Local Oscillator frequency and the resulting L-Band (operating) Frequency are shown in Table 3 for both C-Band (3.7 GHz through 4.2 GHz) and Ku-Band (10.7 GHz through 15 GHz) operation.

Table 3. C and Ku-Band frequency calculations

Band	L-Band (operating) frequency calculation
C-Band	L-Band frequency = $f^1$ (Local Oscillator) - $f$ (Downlink)
Ku-Band	L-Band frequency = $f$ (Downlink) - $f$ (Local Oscillator)

<sup>1</sup> Frequency

<sup>2</sup> Press ALT once for Alt-1 Mode operation

<sup>3</sup> Press ALT twice for Alt-2 Mode operation

<sup>4</sup> Enables or disables Signal Search

Table 4. Available Alt Mode functions

Alt-1	Description	Press	Alt-2	Description	Press
C/Ku	Band Select	1	BAUD	Baud Rate	1
FEC	FEC Rate	2	LO1	Local Osc. Freq. # 1	2
S.Q.	Signal Quality	3	LOCK	Lock Level	3
MODE	Frequency Mode	4	-	-	4
SYM	Symbol Rate	5	LO 2	Local Osc. Freq. # 2	5
SIG	Signal Strength	6	WIDE	Aspect Ratio	6
FREQ	Frequency	7	-	-	7
POL	Signal Polarization	8	XOVER	Crossover Frequency	8
AFC	Auto Frequency Control	9	-	-	9
ALT	Alt Mode 1	ALT <sup>2</sup>	ALT	Alt Mode 2	ALT <sup>3</sup>
-	-	0	SEARCH	Signal Search <sup>4</sup>	0
VIEW	Exit to video	VIEW	VIEW	Exit to video	VIEW
Save	Saves each change	SELECT	Save	Saves each change	SELECT

The examples that follow are provided to help explain how frequency settings can be changed by switching from lower to higher resolution at the front panel display. The (default) lower resolution display (i.e., four most significant digits) changes the value up or down in larger steps for making coarse adjustments. When selected, the higher resolution display (i.e., four least significant digits) changes the value up or down in smaller steps for making fine adjustments. When in Alt-1 or Alt-2 Mode, pressing the up  $\uparrow$  or down  $\downarrow$  arrow button advances the frequency up or down. You use the left  $\leftarrow$  or right  $\rightarrow$  arrow button to change from low to high resolution. Note that when displaying high resolution (i.e., least significant digits), the decimal point appearing after the least significant digit flashes ON and OFF repeatedly.

**Downlink frequency:** (see Figure 7) For example; if the current Downlink frequency is 12.25225 GHz, changing to Alt-1 Mode (ALT LED flashes) and then pressing 7 displays the four most significant digits on the front panel (i.e., 12.25). At low resolution (A), pressing the up  $\uparrow$  or down  $\downarrow$  arrow button advances the frequency up or down in 10 MHz steps (i.e., 12.26, 12.27, and so on). Pressing and holding down the up  $\uparrow$  or down  $\downarrow$  arrow button will increase the step size further.

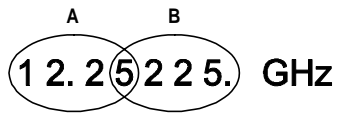

Figure 7. Downlink frequency low and high-resolution display

For high resolution (B), pressing the left  $\leftarrow$  or right  $\rightarrow$  arrow button displays the four least significant digits (i.e., 5225). At high resolution (decimal point flashes ON and OFF), pressing the up  $\uparrow$  or down  $\downarrow$  arrow button advances the frequency up or down in 250 kHz steps (i.e., 5250, 5275, and so on). Pressing and holding down the up  $\uparrow$  or down  $\downarrow$  arrow button will increase the step size further.

**L-Band frequency:** (see Figure 8) For example; if a current L-Band frequency is 1502.25 MHz, changing to Alt-1 Mode (ALT LED flashes) and pressing 4 (to display Lb1 or Lb2), and then pressing 7 displays the four most significant digits on the front panel (i.e., 1502.). At low resolution (A), pressing the up  $\uparrow$  or down  $\downarrow$  arrow button advances the frequency up or down in 1 MHz steps (i.e., 1503., 1504., and so on). Pressing and holding down the up  $\uparrow$  or down  $\downarrow$  arrow button will increase the step size further.

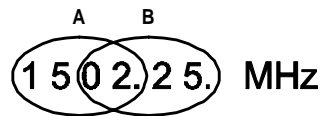

Figure 8. L-Band frequency low and high-resolution display

For high resolution (B), pressing the left  $\leftarrow$  or right  $\rightarrow$  arrow button displays the four least significant digits (i.e., 02.25). At high resolution (decimal point flashes ON and OFF), pressing the up  $\uparrow$  or down  $\downarrow$  arrow button advances the frequency up or down in 250 kHz steps (i.e., 02.50, 02.75 and so on). Pressing and holding down the up  $\uparrow$  or down  $\downarrow$  arrow button will increase the step size further.

**Local Oscillator frequency:** (see Figure 10) For example; if a current Local Oscillator frequency is 10.750 GHz, changing to Alt-2 Mode (ALT LED is on) and then pressing 2 displays the four most significant digits on the front panel (i.e., 10.75). At low resolution (A), pressing the up  $\uparrow$  or down  $\downarrow$  arrow button advances the frequency up or down in 10 MHz steps (i.e., 10.76, 10.77, and so on). Pressing and holding down the up  $\uparrow$  or down  $\downarrow$  arrow button will increase the step size further.

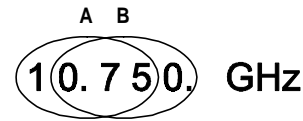

Figure 10. Local Oscillator frequency low and high-resolution display

For high resolution (B), pressing the left  $\leftarrow$  or right  $\rightarrow$  arrow button displays the four least significant digits (i.e., 0.750). At high resolution (decimal point flashes ON and OFF), pressing the up  $\uparrow$  or down  $\downarrow$  arrow button advances the frequency up or down in 1 MHz steps (i.e., 0.751, 0.752, and so on). Pressing and holding down the up  $\uparrow$  or down  $\downarrow$  arrow button will increase the step size further.

**Crossover frequency:** Because the Crossover and LO frequency ranges are similar, refer to the above example for changing the Crossover frequency using the high and low resolution front panel display (see Figure 10).

## ...About changing the Symbol Rate

The example that follows is provided to help explain how the Symbol Rate setting can be changed by switching from lower to higher resolution at the front panel display. The (default) lower resolution (i.e., four most significant digits) changes the value up or down in larger steps for making coarse adjustments. When selected, the higher resolution (i.e., four least significant digits) changes the value up or down in smaller steps for making fine adjustments. You can use the left  $\leftarrow$  or right  $\rightarrow$  arrow button to change from low to high resolution display. When displaying high resolution (i.e., least significant digits), the decimal point appearing after the least significant digit flashes ON and OFF repeatedly.

**Symbol Rate:** (see Figure 9) For example; if the current Symbol Rate is 28.3465 Msymbols/s, changing to Alt-1 Mode (ALT LED flashes) and then pressing 5 displays the four most significant digits on the front panel (i.e., 28.34). At low resolution (A), pressing the up  $\uparrow$  or down  $\downarrow$  arrow button advances the Symbol Rate up or down in 10 Kbit/s steps (i.e., 28.35, 28.36, and so on). Pressing and holding down the up  $\uparrow$  or down  $\downarrow$  arrow button will increase the step size further.

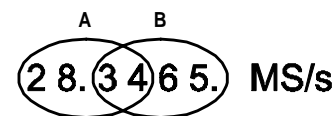

Figure 9. Symbol rate low and high-resolution display

For high resolution (B), pressing the left ← or right → arrow button displays the four least significant digits (i.e., 3465). At high resolution (decimal point flashes ON and OFF), pressing the up ↑ or down ↓ arrow button advances the Symbol Rate up or down in 100 bit/s steps (i.e., 3466, 3467 and so on). Pressing and holding down the up ↑ or down ↓ arrow button will increase the step size further.

## AFC Level

**Display only:** The AFC (Automatic Frequency Control) Level display option is an Alt-1 Mode function. The displayed AFC Level (any number from -50 through +50) is the current relative offset from the set center frequency of the decoded digital signal. The receiver automatically compensates for a +/- 2.5 MHz frequency offset which is equivalent to an AFC Level of approximately +/- 12.

**To display the AFC Level...**

**Step 1.** Press **ALT** once to change from normal operation to Alt-1 Mode.  
The ALT LED flashes ON and OFF.

**Step 2.** Press **9** (AFC) to display the AFC Level.

The AFC Level can be displayed from any channel.

## Alt-1 Mode

**To operate the receiver in Alt-1 Mode...**

**Step 1.** Press the ALT button on the receiver front panel once. If you are already operating in Alt-2 Mode, press the ALT button twice.  
The ALT LED flashes to confirm Alt-1 Mode operation.

While the receiver is operating in Alt-1 Mode, the ALT LED flashes ON and OFF, and only Alt-1 functions are available via front panel buttons. Pressing ALT twice (or pressing VIEW) returns the receiver to normal operation (i.e., the ALT LED is OFF).

## Alt-2 Mode

**To operate the receiver in Alt-2 Mode...**

**Step 1.** Press the ALT button on the receiver front panel twice. If you are already operating in Alt-1 Mode, press the ALT button once.  
The ALT LED is ON to confirm Alt-2 Mode operation.

While the receiver is operating in Alt-2 Mode, the ALT LED is ON, and only Alt-2 functions are available. Pressing ALT once (or pressing VIEW) returns the receiver to normal operation (i.e., the ALT LED is OFF).

## Aspect Ratio

**Display only:** The Aspect Ratio option is an Alt-2 Mode function. The selected Aspect Ratio lets you view programming broadcast in normal/narrow (4 X 3) or wide (16 X 9) format on your TV monitor. Wide format is available when wide aspect ratio information is included with the broadcast, and only if enabled at the uplink. If you are unsure about which Aspect Ratio to use, contact your dealer/reseller, or local service provider.

**To display the Aspect Ratio...**

**Step 1.** Press **ALT** twice to change from normal operation to Alt-2 Mode.  
The ALT LED is ON.

**Step 2.** Press **6** (WIDE) to display the current Aspect Ratio setting. Available settings are 4-3 [4X3 or Normal] or 16-9 [16X9 or Wide]. The default setting is 4X3 (Normal).

The Aspect Ratio can be displayed from any channel.

# Baud Rate

The Baud Rate option is an Alt-2 Mode function. The selected Baud Rate sets the Baud Rate for the serial Expansion Port (if used). If you are unsure about which Baud Rate to use, contact your dealer/reseller, or local service provider.

## To display or change the Baud Rate...

- Step 1.** Press **ALT** twice to change from normal operation to Alt-2 Mode.  
The ALT LED is ON.
- Step 2.** Press **1** (BAUD) to display the current Baud Rate. Pressing **1** repeatedly displays available settings [600, 1200, 2400, 4800 or 9600 baud] ). The default setting is 9600.
- Step 3.** When the desired setting is displayed on-screen, press **SELECT** to change the current setting.  
The front panel displays "sav?".

**Available options:** Press **1** to save the new setting (donE), or press **2** to discard all changes (rstr), or press **3** to cancel the operation (abrt).

Repeat this action to change to another Baud Rate. The Baud Rate can be displayed or changed from any channel.

# FEC Rate

The FEC Rate option is an Alt-1 Mode function. The selected FEC Rate must match the FEC Rate associated with the transmitted signal. If you are unsure about which FEC rate to use, contact your dealer/reseller, or local service provider.

## To display or change the FEC rate...

Perform the first step if you are changing the FEC Rate.

- Step 1.** If required, press **0** and then press **SELECT** to display the Installer Channel.
- Step 2.** Press **ALT** once to change from normal operation to Alt-1 Mode.  
The ALT LED flashes ON and OFF.

**Step 3.** Press **2** (FEC) to display the current FEC Rate. Pressing **2** repeatedly displays available settings (1-2 [1/2], 2-3 [2/3], 3-4 [3/4], 5-6 [5/6], or 7-8 [7/8]). The default setting is 7/8.

**Step 4.** When the desired setting is displayed on-screen, press **SELECT** to change the current setting.  
The front panel displays "sav?".

**Available options:** Press **1** to save the new setting (donE), or press **2** to discard all changes (rstr), or press **3** to cancel the operation (abrt).

Repeat this action to change the FEC Rate. The FEC Rate can be displayed from any channel, but can only be changed from the Installer Channel (see "...About the current channel").

# Band Select

**Display only:** The Band Select display option is an Alt-1 Mode function. The operating (frequency) band displayed identifies the operating L-Band frequency (C-Band or Ku-Band) used by the receiver (see also "Frequency Mode"). The operating band can only be set via the menu interface. If you are unsure about which frequency to use, contact your dealer/reseller, or local service provider.

## To display the operating band...

- Step 1.** Press **ALT** once to change from normal operation to Alt-1 Mode.  
The ALT LED flashes ON and OFF.
- Step 2.** Press **1** (C/Ku) to display the current operating band (C or U [Ku]).

The operating Band can be displayed from any channel.

## Crossover frequency

The Crossover frequency option is an Alt-2 Mode function. The Crossover frequency is an internal threshold frequency used for selecting the L-Band 1 or L-Band 2 frequency, depending on the current Downlink and L-Band frequency settings. The Crossover frequency is valid only if the Frequency Mode is set to Downlink (dnLn). If you are unsure about which Crossover Frequency to use, contact your dealer/reseller, or local service provider.

### To display or change the Crossover Frequency...

Perform the first step if you are changing the Crossover Frequency.

**Step 1.** If required, press **O** and then press **SELECT** to display the Installer Channel.

**Step 2.** Press **ALT** *twice* to change from normal operation to Alt-2 Mode.  
The ALT LED is ON.

**Step 3.** Press **B** (XOVER) to display the current Crossover frequency. Pressing the **↑/↓** arrow button displays higher or lower frequency settings (frequencies are displayed from 0 GHz through 15 GHz). The default setting is 11.700 GHz.

**Step 4.** When the desired setting is displayed on-screen, press **SELECT** to change the current setting.  
The front panel displays "sav?".

**Available options:** Press 1 to save the new setting (donE), or press 2 to discard all changes (rstr), or press 3 to cancel the operation (abrt).

Repeat this action to change to another frequency. You use the left **←** or right **→** arrow button to change from low to high resolution. Note that when displaying high resolution (i.e., least significant digits), the decimal point flashes ON and OFF repeatedly (see "...About frequency settings"). The Crossover frequency can be displayed from any channel, but can only be changed from the Installer Channel (see "...About the current channel"). A Crossover frequency is only required when the Frequency Mode is set to Downlink (dnLn), and is not valid if set to L-Band 1 [Lb1] or L-Band 2 [Lb2]. For more information about frequency settings, see "Setting up the receiver".

## Factory Reset

The Factory Reset option is an Alt-1 Mode function, and is used to replace the current receiver settings with the factory default settings. If you are unsure about using factory default settings, contact your dealer/reseller, or local service provider. For information about factory default receiver settings, see "Setting up the receiver" (see also Table 8).

### To perform a Factory Reset...

**Step 1.** Press **O** and then press **SELECT** to display the Installer Channel.

**Step 2.** Press **ALT** *once* to change from normal operation to Alt-1 Mode.  
The ALT LED flashes ON and OFF.

**Step 3.** Press the Up **↑** and Down **↓** arrow buttons simultaneously.  
The front panel displays "do?".

**Step 4.** Press the Left **←** and Right **→** arrow buttons simultaneously to initiate the Factory Reset (pressing any other key aborts the action).

Repeat this action to restore the factory default settings. Once initiated, a Factory Reset cannot be interrupted or reversed. A Factory Reset can only be performed from the Installer Channel (see "...About the current channel").

## Frequency

The Frequency option is an Alt-1 Mode function. The displayed Frequency is the current Downlink [dnLn], L-Band 1 [Lb1] or L-Band 2 [Lb2] operating frequency used by the receiver for tuning the received digital signal. If you are unsure about which Frequency to use, contact your dealer/reseller, or local service provider.

### To display or change the operating Frequency...

Perform the first step if you are changing the operating Frequency.

**Step 1.** If required, press **O** and then press **SELECT** to display the Installer Channel.

**Step 2.** Press **ALT** *once* to change from normal operation to Alt-1 Mode.  
The ALT LED flashes ON and OFF.

**Step 3.** Press **7** (FRQ) to display the current operating Frequency. The Frequency display is preceded by the current Frequency Mode setting. The default Frequency setting is 950 MHz.

**Step 4.** Press the **↑/↓** arrow buttons to display available settings (frequencies are displayed from 950 MHz through 15 GHz).

**Step 5.** When the desired setting is displayed at the front panel, press **SELECT** to save the setting.  
The front panel displays “sav?”.

**Available options:** Press **1** to save the new setting (donE), or press **2** to discard all changes (rstr), or press **3** to cancel the operation (abrt).

Repeat this action to display or change the operating frequency. You can use the **←/→** arrow buttons to change between low and high resolution. Note that when displaying high resolution (i.e., least significant digits), the decimal point flashes ON and OFF repeatedly (see “...About frequency settings”). The operating frequency can be displayed from any channel, but can only be changed from the Installer Channel (see “...About the current channel”).

## Frequency Mode

The Frequency Mode option is an Alt-1 Mode function. The mode selected is the Downlink (dnLn) or L Band (Lb1 or Lb2) Frequency Mode used by the receiver. If you are unsure about which Frequency Mode to use, contact your dealer/reseller, or local service provider.

### To display or change the Frequency Mode...

Perform the first step if you are changing the Frequency Mode.

**Step 1.** If required, press **0** and then press **SELECT** to display the Installer Channel.

**Step 2.** Press **ALT** once to change from normal operation to Alt-1 Mode.  
The ALT LED flashes ON and OFF.

**Step 3.** Press **4** (MODE) to display the current Frequency Mode (Lb1 [L-Band 1], Lb2 [L-Band 2] or dnLn [Downlink]). The default setting is L-Band 1.

**Step 4.** Press **4** repeatedly until the desired setting is displayed at the front panel, and then press **SELECT** to set the new Frequency Mode.  
The front panel displays “sav?”.

**Available options:** Press **1** to save the new setting (donE), or press **2** to discard all changes (rstr), or press **3** to cancel the operation (abrt).

Repeat this action to change the Frequency Mode. The Frequency Mode can be displayed from any channel, but can only be changed from the Installer Channel (see “...About the current channel”). Each Frequency Mode corresponds to a valid Local Oscillator or Downlink frequency (see also “LO Frequency #1”, “LO Frequency #2”) and “Crossover frequency”).

## Lock Level

The Lock Level option is an Alt-2 Mode function. The Lock Level determines what receiver/interface options are available for viewing and/or modification. If you are unsure about which Lock Level to use, contact your dealer/reseller, or local service provider.

### To display or change the Lock Level...

Perform the first step if you are changing the Lock Level.

**Step 1.** Press **ALT** twice to change from normal operation to Alt-2 Mode.  
The ALT LED is ON.

**Step 2.** Press **3** (LOCK) to display the current Lock Level. Pressing **3** repeatedly displays available settings (Lock Levels are displayed from 0 through 3). The default setting is 0.

**Step 3.** When the desired setting is displayed at the front panel, press **SELECT** to set the new Lock Level.  
A prompt displays for entering the current Password.

**Step 4.** Enter the current Password.  
After the correct Password is entered, the new Lock Level is set.

Repeat this action to change the Lock Level setting. The Lock Level setting can be changed from any channel. If Lock Level 3 is set and any button is pressed, you are prompted to enter the current Password. After the correct Password is entered, the Lock Level setting is automatically changed to Level 0. If an incorrect Password is entered, "bAd" is displayed at the front panel. For more information about Lock Levels, see "...About Lock Levels".

## LO Frequency #1

The LO (Local Oscillator) Frequency #1 option is an Alt-2 Mode function. The LO Frequency #1 sets the satellite antenna LNB local oscillator #1 frequency, and is valid only if the Frequency Mode is set to L-Band 1 (Lb1) or Downlink (dnLn). If you are unsure about which Local Oscillator Frequency to use, contact your dealer/reseller, or local service provider.

### To display or change the LO Frequency #1...

Perform the first step if you are changing the LO Frequency #1.

**Step 1.** If required, press **0** and then press **SELECT** to display the Installer Channel.

**Step 2.** Press **ALT** twice to change from normal operation to Alt-2 Mode.  
The ALT LED is ON.

**Step 3.** Press **2** (LO 1) to display the current LO Frequency #1. Pressing the **↑/↓** arrow button displays higher or lower frequency settings (frequencies are displayed from 0 GHz through 15 GHz (see "...About frequency settings"). The default setting is 9.750 GHz.

**Step 4.** When the desired setting is displayed at the front panel, press **SELECT** to save the setting.  
The front panel displays "sav?".

**Available options:** Press 1 to save the new setting (donE), or press 2 to discard all changes (rstr), or press 3 to cancel the operation (abrt).

Repeat this action to change to another frequency. You can use the **←/→** arrow buttons to change between low and high resolution. When displaying high resolution (i.e., least significant digits), the decimal point flashes ON and OFF repeatedly. The Local Oscillator #1 frequency can be displayed from any channel, but can only be changed from the Installer Channel (see "...About the current channel"). The Local Oscillator #1 frequency is associated with the L-Band 1 [Lb1] Frequency Mode, and must be lower than the Local Oscillator #2 frequency. For more information about frequency settings, see "Setting up the receiver".

## LO Frequency #2

The LO (Local Oscillator) Frequency #2 option is an Alt-2 Mode function. The LO Frequency #2 sets the satellite antenna LNB Local Oscillator #2 frequency, and is valid only if the Frequency Mode is set to L-Band 2 (Lb2) or Downlink (dnLn). If you are unsure about which Local Oscillator Frequency to use, contact your dealer/reseller, or local service provider.

### To display or change the LO Frequency #1...

Perform the first step if you are changing the LO Frequency #2.

**Step 1.** If required, press **0** and then press **SELECT** to display the Installer Channel.

**Step 2.** Press **ALT** twice to change from normal operation to Alt-2 Mode.  
The ALT LED is ON.

**Step 3.** Press **5** (LO 2) to display the current LO Frequency #2. Pressing the **↑/↓** arrow button displays higher or lower frequency settings (frequencies are displayed from 0 GHz through 15 GHz (see "...About frequency settings"). The default setting is 10.600 GHz.

**Step 4.** When the desired setting is displayed at the front panel, press **SELECT** to save the setting.  
The front panel displays "sav?".

**Available options:** Press 1 to save the new setting (donE), or press 2 to discard all changes (rstr), or press 3 to cancel the operation (abrt).

Repeat this action to change to another frequency. You can use the  $\leftarrow/\rightarrow$  arrow buttons to change between low and high resolution. When displaying high resolution (i.e., least significant digits), the decimal point flashes ON and OFF repeatedly. The Local Oscillator #2 frequency can be displayed from any channel, but can only be changed from the Installer Channel (see "...About the current channel"). The Local Oscillator #2 frequency is associated with the L-Band 2 [Lb2] and Downlink (dnLn) Frequency Mode, and is required if you are using a dual Ku-Band LNB system. If used, the Local Oscillator #2 frequency must be higher than the Local Oscillator #1 frequency. For more information about frequency settings, see "Setting up the receiver".

## Signal Quality

**Display only:** The Signal Quality display option is an Alt-1 Mode function. The displayed Signal Quality (any number from 0 through 10) is related to the Bit Error Rate (higher numbers [for Signal Quality] are better).

To display the Signal Quality...

**Step 1.** Press **ALT** *once* to change from normal operation to Alt-1 Mode.  
The ALT LED flashes ON and OFF.

**Step 2.** Press **3** (S.Q.) to display the Signal Quality.

The Signal Quality can be displayed from any channel.

## Signal Polarization

The signal Polarization option is an Alt-1 Mode function. The selected signal Polarization must match the polarization of the transmitted signal. If you are unsure about which Polarization to use, contact your dealer/reseller, or local service provider.

To display or change the Signal Polarization...

Perform the first step if you are changing the Signal Polarization.

**Step 1.** If required, press **0** and then press **SELECT** to display the Installer Channel.

**Step 2.** Press **ALT** *once* to change from normal operation to Alt-1 Mode.  
The ALT LED flashes ON and OFF.

**Step 3.** Press **8** (POL) to display available settings (H [Horizontal], HF [Horizontal, Fixed], U [Vertical] or U F [Vertical, Fixed]). The default setting is H (Horizontal).

**Step 4.** When the desired setting is displayed at the front panel, press **SELECT** to save the setting.  
The front panel displays "sav?".

**Available options:** Press 1 to save the new setting (donE), or press 2 to discard all changes (rstr), or press 3 to cancel the operation (abrt).

Repeat this action to change the Polarization. The Polarization can be displayed from any channel, but can only be changed from the Installer Channel (see "...About the current channel"). When a Horizontal polarization is set, a 19 volt DC signal is output via the receiver rear panel SATELLITE connector. When a Vertical polarization is set, a 13 volt DC signal is output via this connector. If a fixed Horizontal or Vertical polarization is set, the setting cannot be changed via uplink control. Observe the effect of the Polarization change by checking the displayed relative Signal Strength value (see "Signal Strength"). Higher Signal Strength numbers are better.

## Signal Search

The Search option is an Alt-2 mode function. Searching for a signal with the Search option is used for restoring normal receiver operation if the received signal is interrupted or lost, or is changed by the local broadcast satellite services provider.

A signal search is enabled by setting the Search option to ON, and disabled by setting this option to OFF. When enabled, a signal search is activated automatically only if the carrier signal is interrupted or lost for more than 20 seconds (normal operating mode only). For more information about Signal Searches, see "Setting up the receiver".



### To display or change the Search setting...

- Step 1.** Press **ALT** twice to change from normal operation to Alt-2 Mode.  
The ALT LED is ON.
- Step 2.** Press **0** to display the current Search setting. Pressing **0** repeatedly displays available settings (SON or SOFF). The default setting is SOFF (OFF).
- Step 3.** When the desired setting is displayed at the front panel, press **SELECT** to save the setting.  
The front panel displays "sav?".

**Available options:** Press **1** to save the new setting (donE), or press **2** to discard all changes (rstr), or press **3** to cancel the operation (abrt).

Repeat this action to change (i.e., enable or disable) the Search setting. A Signal Search can be executed from any channel. For more information about signal searches, see "Setting up the receiver".

## Signal Strength

**Display only:** The Signal Strength option is an Alt-1 Mode function. The displayed Signal Strength (any number from 0 through 99) is associated with the Symbol Rate and signal input level.

### To display the Signal Strength...

- Step 1.** Press **ALT** once to change from normal operation to Alt-1 Mode.  
The ALT LED flashes ON and OFF.
- Step 2.** Press **6** (SIG) to display the Signal Strength.
- The Signal Strength can be displayed from any channel.

## Symbol Rate

The Symbol Rate option is an Alt-1 Mode function. The selected Symbol Rate must match the Symbol Rate associated with the transmitted signal. If you are unsure about which Symbol Rate to use, contact your dealer/reseller, or local service provider.

### To display or change the Symbol Rate...

Perform the first step if you are changing the Symbol Rate.

- Step 1.** If required, press **0** and then press **SELECT** to display the Installer Channel.
- Step 2.** Press **ALT** once to change from normal operation to Alt-1 Mode.  
The ALT LED flashes ON and OFF.
- Step 3.** Press **5** (SYM) to display the current Symbol Rate. Pressing the **↑/↓** arrow buttons displays higher or lower settings (Symbol Rates are displayed from 3 MS/s through 30.8000 MS/s in 10 KS/s steps). The default setting is 28.3465 MS/s.
- Step 4.** When the desired setting is displayed at the front panel, press **SELECT** to save the setting.  
The front panel displays "sav?".

**Available options:** Press **1** to save the new setting (donE), or press **2** to discard all changes (rstr), or press **3** to cancel the operation (abrt).

Repeat this action to change to another Symbol Rate (see "...About changing the Symbol Rate"). You can use the **←/→** arrow buttons to change between low and high resolution (see "...About frequency settings"). The Symbol Rate can be displayed from any channel, but can only be changed from the Installer Channel (see "...About the current channel").

# View

The View option is an Alt Mode function (i.e., Alt-1 or Alt-2 Mode), and is provided for exiting from Alt Mode to video (current channel).

**To exit from Alt Mode to video...**

**Step 1.** Press **VIEW** to exit from Alt Mode to video (i.e., return to normal receiver operation). You can also exit from Alt Mode to the current channel by pressing the ALT button until the ALT LED is OFF).

**Step 2.** If an unsaved change exists, you are prompted to save, discard or cancel the change by pressing the appropriate front panel buttons.

**Available options:** Press 1 to save the new settings (donE), or press 2 to discard all changes (rstr), or press 3 to cancel the operation (abrt).

# On-screen menu operation

Setting up your Headend Satellite Receiver via the menu interface requires setup of frequency-related and other options. These settings are used by the receiver for locking onto the signal, and for optimizing receiver performance. Most menu interface functions are also available via the Alt Mode interface.

While viewing any channel, you can display on-screen menus to view or change the current receiver setup. Menu interface functions are available via receiver front panel buttons. As with the Alt Mode interface, access to menu functions is controlled by system Lock Levels and the security Password. More information about Lock Levels and the Password is contained in this section.

## ...About on-screen menu operation

While viewing any channel, you can display on-screen menus for viewing or changing the current receiver setup. Using the menu interface, you can change the current receiver settings, and/or display other menus. Some menus contain setup information which is available for viewing only, and cannot be changed. Numbered menu options are used to display other menus. Access to menus and changeable menu options is controlled by system Lock Levels and a security Password. For more information about Lock Levels and the Password, see “Setting up the receiver (see also “User Setup”).

### To display on-screen menus...

**Step 1.** Press the **MENU** button.

Depending on the current Lock Level setting, you may be prompted for the current Password. If Lock Level 3 is set, an on-screen prompt displays for entering the current Password. Otherwise, the Main Menu displays.

**Step 2.** If required, enter the current Password and press **SELECT** to display the Main Menu (for security, a default character is substituted for each number pressed).

For more information about the Password, see “...About the Password” (see also “Setting up the receiver”).

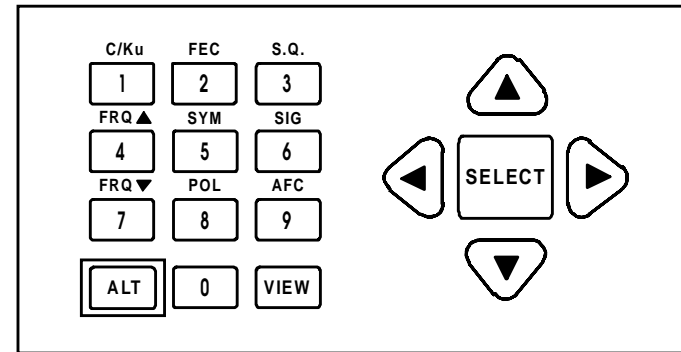

Figure11. Front panel keypad showing Alt-1 functions

# Receiver Setup menu

Setting up your Headend Satellite Receiver for normal operation requires setup of frequency-related and other options from the Receiver Setup menu, and from other menus. These settings are used by the receiver for locking onto a network signal, and for optimizing receiver performance (see also “User Setup menu” and “Search Setup menu”). You can view or change the current setup.

Most of the functions needed to set up your Headend Satellite Receiver are available from the Receiver Setup menu. This menu lets you set up your receiver to lock onto a single network signal. However, if you wish to setup your receiver to lock onto more than one network signal and store each configuration set, use the Network Presets menu. (See also “Network Presets menu”.)

## To display the Receiver Setup menu...

- Step 1.** Display the **Main Menu** (see Figure 5).
- Step 2.** Move to **Receiver Status** and press **SELECT**.
- Step 3.** Move to **Receiver Setup** and press **SELECT**.

**Available options:** Select **SEARCH SETUP** (or press 2 and then **SELECT**) to display the Search Setup menu, or select **RECEIVER STATUS** (or press 3 and then **SELECT**) to display the Receiver Status menu.

## ...About frequency settings

As you make changes to the current setup (at the Receiver Setup menu), the receiver checks that the Local Oscillator frequencies, Crossover frequency, Frequency and Frequency Mode settings are compatible with each other. A Crossover frequency is required only if you are using both Local Oscillators (i.e., you have a dual-band LNB and you are entering a Frequency with Downlink Mode set). If used, the Local Oscillator Frequency #2 must be greater than Local Oscillator Frequency #1. The operating Frequency, Local Oscillator frequencies plus the Crossover frequency must be correctly set as specified by your antenna/LNB manufacturer, dealer/reseller or local service provider. The Frequency setting plus other settings used depend on subscriber/network services available, and may vary.

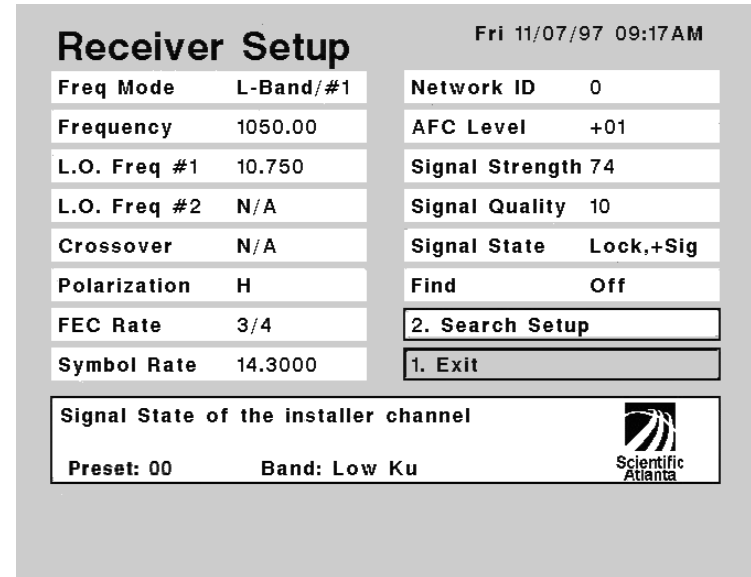

Figure 12. Receiver Setup menu display

You can enter a valid frequency using the numbered Remote Control buttons, and/or you can use the  $\uparrow/\downarrow$  arrow buttons to display available settings. If the current setting is out of range or is incompatible with other settings, a pop-up message displays setup error information, or N/A (Not Applicable) will display for the setting. Setup errors must be corrected before the new setup can be saved. For information about saving changes, see “...About saving changes”.

The relationships between the Downlink frequency, the Local Oscillator frequency and the resulting L-Band (operating) Frequency are shown in the accompanying table for both C-Band (3.7 GHz through 4.2 GHz) and Ku-Band (10.7 GHz through 15 GHz) operation.

Table 5. C and Ku-Band frequency calculations

Band	L-Band (operating) frequency calculation
C-Band	L-Band frequency = $f^1$ (Local Oscillator) - $f$ (Downlink)
Ku-Band	L-Band frequency = $f$ (Downlink) - $f$ (Local Oscillator)

<sup>1</sup> Frequency

Pop-up error messages that display for invalid settings are listed in Table 6. Use this information to help you correct frequency-related receiver setup errors. The pages that follow contain detailed setup information for each Receiver Setup menu option.

**Table 6. Pop-up error messages**

Displayed Messages
Local Oscillator frequency #2 is not valid for Ku-Band
Local Oscillator frequency #2 is less than Local Oscillator Frequency #1
Downlink frequency entered is out of range
Downlink frequency calculated from L-Band is out of range
L-Band frequency calculated from Downlink is out of range

#### To set the Frequency Mode...

**Step 1.** Move to **Freq Mode** and press SELECT to display available settings (L-Band/1, L-Band/2 or Downlink). The default setting is L-Band/1.

**Step 2.** When the desired setting is displayed on-screen, move to Exit and press SELECT, or press 1 and then press SELECT to change the current setting. A pop-up menu displays Save options.

**Step 3.** Press 1 to save the new setting (YES), or follow the on-screen instructions, as required.

**Available options:** Press 1 to save the new settings (Yes), or press 2 to discard all changes (No), or press 3 to cancel the operation (Cancel).

Repeat this action to change to another Frequency Mode. A valid Frequency Mode is always required (i.e., for setting the L-Band or Downlink frequency).

#### To set the operating Frequency...

**Step 1.** Move to **Frequency** and press SELECT to replace the current setting.

**Step 2.** Enter a valid frequency and then press SELECT. You can also press the  $\uparrow/\downarrow$  arrow buttons to display available settings (frequencies are displayed from 950 MHz through 2150 MHz [L-Band] and from 0 GHz through 15 GHz [Downlink] in 250 kHz steps). The default setting is 950 MHz.

**Step 3.** When the desired setting is displayed on-screen, move to Exit and press SELECT, or press 1 and then press SELECT to change the current setting. A pop-up menu displays Save options.

**Step 4.** Press 1 to save the new setting (YES), or follow the on-screen instructions, as required.

**Available options:** Press 1 to save the new settings (Yes), or press 2 to discard all changes (No), or press 3 to cancel the operation (Cancel).

Repeat this action to change to another frequency. A valid operating Frequency is always required (i.e., for setting the L-Band or Downlink frequency).

#### To set the Local Oscillator #1 frequency...

**Step 1.** Move to **LO Freq #1** and press SELECT to replace the current setting.

**Step 2.** Enter a valid frequency and then press SELECT. You can also press the  $\uparrow/\downarrow$  arrow buttons to display available settings (frequencies are displayed from 0 GHz through 15 GHz in 1 MHz steps). The default setting is 9.750 GHz.

**Step 3.** When the desired setting is displayed on-screen, move to Exit and press SELECT, or press 1 and then press SELECT to change the current setting. A pop-up menu displays Save options.

**Step 4.** Press 1 to save the new setting (YES), or follow the on-screen instructions, as required.

**Available options:** Press 1 to save the new settings (Yes), or press 2 to discard all changes (No), or press 3 to cancel the operation (Cancel).

Repeat this action to change to another frequency. A Local Oscillator #1 frequency setting is required only if Downlink or L-Band/1 Frequency Mode are set (N/A<sup>1</sup> displayed if Frequency Mode set to L-Band/2).

#### To set the Local Oscillator #2 frequency...

**Step 1.** Move to **LO Freq #2** and press SELECT to replace the current setting.

---

<sup>1</sup> Not Applicable

**Step 2.** Enter a valid frequency and then press SELECT. You can also press the  $\uparrow/\downarrow$  arrow buttons to display available settings (frequencies are displayed from 0 GHz through 15 GHz in 1 MHz steps). The default setting is 10.600 GHz.

**Step 3.** When the desired setting is displayed on-screen, move to Exit and press SELECT, or press 1 and then press SELECT to change the current setting. A pop-up menu displays Save options.

**Step 4.** Press 1 to save the new setting (YES), or follow the on-screen instructions, as required.

**Available options:** Press 1 to save the new settings (Yes), or press 2 to discard all changes (No), or press 3 to cancel the operation (Cancel).

Repeat this action to change to another frequency. A Local Oscillator #2 frequency setting is required only if the Downlink or L-Band/2 Frequency Mode is set (N/A<sup>1</sup> displayed if Frequency Mode set to L-Band/1, or if operating Frequency in C-Band range [3.7-4.2 GHz]). The Local Oscillator #2 frequency used must be greater than the Local Oscillator #1 frequency.

#### To set the Crossover frequency...

**Step 1.** Move to **Crossover** and press SELECT to replace the current setting.

**Step 2.** Enter a valid frequency and then press SELECT. You can also press the  $\uparrow/\downarrow$  arrow buttons to display available settings (frequencies are displayed from 10.7 GHz through 15 GHz in 250 kHz steps). The default setting is 11.700 GHz.

**Step 3.** When the desired setting is displayed on-screen, move to Exit and press SELECT, or press 1 and then press SELECT to change the current setting. A pop-up menu displays Save options.

**Step 4.** Press 1 to save the new setting (YES), or follow the on-screen instructions, as required.

**Available options:** Press 1 to save the new settings (Yes), or press 2 to discard all changes (No), or press 3 to cancel the operation (Cancel).

Repeat this action to change to another frequency. A Crossover frequency setting is required only if the Downlink Frequency Mode is set (N/A<sup>1</sup> displayed if Frequency Mode set to L-Band/1 or L-Band/2 [not dual Ku-Band LNB operation]). The Crossover frequency setting determines which LNB is used (only for dual-LNB operation).

#### To set the antenna LNB polarization...

**Step 1.** Move to **Polarization** and press SELECT to display available settings (H [Horizontal], H [Fixed], V [Vertical]) or V (Fixed). The default setting is H (Horizontal).

**Step 2.** When the desired setting is displayed on-screen, move to Exit and press SELECT, or press 1 and then press SELECT to change the current setting. A pop-up menu displays Save options.

**Step 3.** Press 1 to save the new setting (YES), or follow the on-screen instructions, as required.

**Available options:** Press 1 to save the new settings (Yes), or press 2 to discard all changes (No), or press 3 to cancel the operation (Cancel).

Repeat this action to change the polarization. When a Horizontal polarization is set, a 19 volt DC signal is output via the receiver rear panel SATELLITE connector. When a Vertical polarization is set, a 13 volt DC signal is output via this connector. Observe the effect of the polarization change by checking the displayed relative Signal Strength and Signal Quality values (see Figure 12). Higher numbers are better. If you are unsure about which polarization to use, contact your dealer/reseller, or local service provider.

#### To set the FEC rate...

**Step 1.** Move to **FEC Rate** and press SELECT to display available settings (1/2, 2/3, 3/4, 5/6, or 7/8). The default setting is 7/8.

**Step 2.** When the desired setting is displayed on-screen, move to Exit and press SELECT, or press 1 and then press SELECT to change the current setting. A pop-up menu displays Save options.

**Step 3.** Press 1 to save the new setting (YES), or follow the on-screen instructions, as required.

**Available options:** Press 1 to save the new settings (Yes), or press 2 to discard all changes (No), or press 3 to cancel the operation (Cancel).

Repeat this action to change the FEC Rate. The selected FEC Rate must match the FEC Rate associated with the transmitted signal. If you are unsure about which FEC rate to use, contact your dealer/reseller, or local service provider.

### To set the Symbol Rate...

- Step 1.** Move to **Symbol Rate** and press SELECT to replace the current setting.
- Step 2.** Enter a valid Symbol Rate using the numbered Remote Control buttons and then press SELECT. You can also press the **↑/↓** arrow buttons to display available settings (Symbol Rates are displayed from 3 MS/s through 30.8000 MS/s in 10 KS/s steps). The default setting is 28.3465 MS/s.
- Step 3.** When the desired setting is displayed on-screen, move to Exit and press SELECT, or press 1 and then press SELECT to change the current setting. A pop-up menu displays Save options.
- Step 4.** Press 1 to save the new setting (YES), or follow the on-screen instructions, as required.

**Available options:** Press 1 to save the new settings (Yes), or press 2 to discard all changes (No), or press 3 to cancel the operation (Cancel).

Repeat this action to change to another Symbol Rate. The selected Symbol Rate must match the Symbol Rate associated with the transmitted signal. If you are unsure about which Symbol Rate to use, contact your dealer/reseller, or local service provider.

### To set the Network ID...

- Step 1.** Enter a valid Network ID (number) and then press SELECT. You can also press the **↑/↓** arrow buttons to display available settings (numbers are displayed from 0 through 65535).
- Step 2.** When the desired setting is displayed on-screen, move to Exit and press SELECT, or press 1 and then press SELECT to change the current setting. A pop-up menu displays Save options.
- Step 3.** Press 1 to save the new setting (YES), or follow the on-screen instructions, as required.

**Available options:** Press 1 to save the new settings (Yes), or press 2 to discard all changes (No), or press 3 to cancel the operation (Cancel).

Repeat this action to change the Network ID (see also "...About the Network ID"). Changing the Network ID is normally required only when authorized subscriber services are changed, or when new or different subscriber services are made available (see Figure 12). If you are unsure about which Network ID to use, contact your dealer/reseller, or local service provider. Changing the Network ID may also require that you execute a signal search (see "Search Setup menu" and "...About the Find option").

## ...About the Signal State

During normal operation, your receiver is synchronized with the received LNB signal (confirmed by the "Lock, Sig" status display). If the receiver is able to synchronize to a carrier frequency only and no MPEG stream is present or is recognized, the "Lock, No Sig" status is displayed, and the Signal indicator LED is OFF. If no digital carrier signal is detected, the "No Lock" status is displayed, and the Signal indicator LED is also OFF. If a signal search activated using the "Find" option is in progress, the "Searching" status is displayed. If a signal search activated using the Search function is in progress, the message "Searching for a signal" is displayed. For more information about the Find option, see "...About the Find option". For more information about signal searches, see "...About the Search option".

## ...About the Find option

Searching for a signal with the "Find" option can be used if you are installing your Headend Satellite Receiver for the first time, or if you are modifying the current receiver setup. Activating the Find function forces the receiver to search for a signal immediately. Signal searches are also performed automatically to restore normal receiver operation if the received signal is interrupted or lost, or is changed by the local broadcast satellite services provider.

Once activated, the receiver begins searching for a signal associated with any Network ID. When a possible match is found, the search is temporarily interrupted while the receiver attempts to synchronize with the found signal. If synchronization is successful, the “*Lock, Sig*” status is displayed on-screen, and the settings can be saved, as required before exiting to video (current channel). If receiver synchronization cannot take place, the signal is discarded and the signal search is automatically resumed. If no signal is found, the signal search continues indefinitely, and must be manually terminated (see also “...About the Search option” and “...About the Signal State”).

#### **To Find a signal...**

- Step 1.** Move to **Find** and press SELECT to display ON—activating the signal search (available options are ON and OFF).
- Step 2.** When a signal is found (“*Lock, Sig*” status display), move to Exit and press SELECT (or press 1 and then SELECT).  
A pop-up menu displays Save options.
- Step 3.** Press 1 to save the new setting (YES), or follow the on-screen instructions, as required.

**Available options:** Press 1 to save the new settings (Yes), or press 2 to discard all changes (No), or press 3 to cancel the operation (Cancel).

Repeat this action to search for (i.e., Find) another signal. When the settings are saved, the Find option is automatically set to OFF. You can also terminate the search manually by setting the Find option to OFF.



# User Setup menu

Setting up your Headend Satellite Receiver for normal operation requires that user-related options be set from the User Setup menu. These settings are used for optimizing receiver performance (see also “Receiver Setup menu” and “Search Setup menu”).

To display the User Setup menu...

**Step 1.** Display the Main Menu (Figure 5).

**Step 2.** Move to **Receiver Status** and press SELECT.

**Step 3.** Move to **User Setup** and press SELECT.

You can view or change the current setup. Your dealer/reseller or local service provider can advise you about what receiver settings you may need to change. Move to Exit and press SELECT (or press 1 and then SELECT) to return to the previous menu.

## ...About Lock Levels

Four (4) user-selectable Lock Levels are available for protecting your Headend Satellite Receiver and the current receiver settings against unauthorized use or modification. A Lock Level 0 setting lets you make any changes to the current receiver setup. Lock Levels 1 and 2 settings limit access to settings that cannot compromise the video signal. A Lock Level 3 setting prevents any changes to the current receiver setup by blocking access to menus or to the front panel (i.e., Alt Mode). A Lock Level 4 setting can only be changed via remote terminal (Serial Remote Control commands) or PCC uplink signal, and displays N/A (Not Applicable) if set. When the receiver configuration is protected via Lock Levels 3 or 4, menus cannot be displayed. Note that after setting the Lock Level to 3 and saving changes (menus only), exiting from the User Setup menu automatically returns you to video.

When an attempt is made to change the current Lock Level setting (if set to Level 1, 2 or 3), a Password prompt displays. After the correct Password is entered, the Lock Level setting is automatically reset to Level 0. Similarly, the correct Password is also required before changing the Lock Level setting from Level 0 to Level 1 or higher. If no password is entered (Lock Level 3 is set), or if no other button is pressed within one (1) minute of the banner/prompt display, the current virtual channel displays automatically.

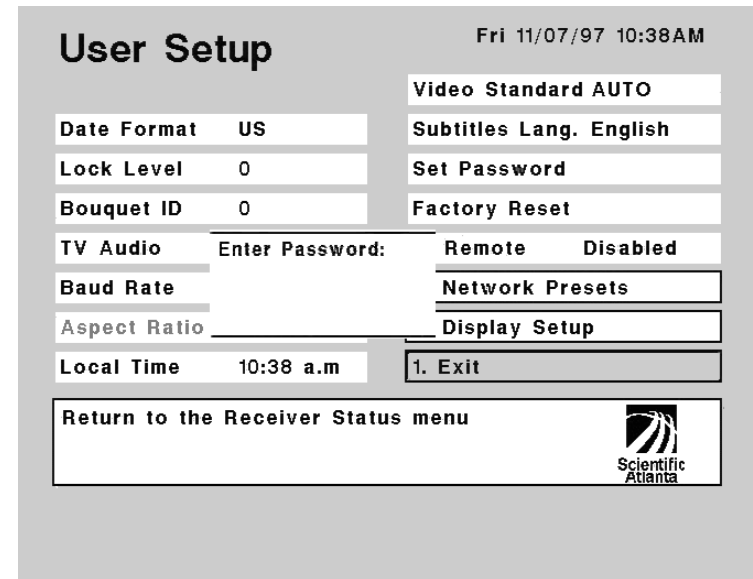

Figure 13. User Setup menu and Password prompt display

If an incorrect Password is entered at the Password prompt, a message displays to confirm the invalid Password, and access to the menu or option is denied (see “...About the Password”). If a change made to the current Lock Level setting is not saved, the previously-saved setting is restored. Table 2 summarizes Lock Level settings and associated receiver options (see “Setting up the receiver”).

To change the Lock Level...

**Step 1.** Move to **Lock Level** and press SELECT to replace the current setting.

**Step 2.** Enter a valid Lock Level (number) and then press SELECT. You can also press the  $\uparrow/\downarrow$  arrow buttons to display available settings (Lock Levels are displayed from 0 through 3). The default setting is 0. A pop-up displays for entering the current Password.

**Step 3.** Enter the current Password and press SELECT (for security, a default character is substituted for each button pressed).

**Step 4.** Move to Exit and press SELECT, or press 1 and then press SELECT to change the current setting. A pop-up menu displays Save options.

**Step 5.** Press 1 to save the new setting (YES), or follow the on-screen instructions, as required.

The receiver settings are enabled or disabled, depending on the Lock Level set.

**Available options:** Press 1 to save the new settings (Yes), or press 2 to discard all changes (No), or press 3 to cancel the operation (Cancel).

Repeat this action to change the Lock Level setting. Menu options appear grayed-out if disabled by the current Lock Level setting.

#### To display the Main Menu (if Lock Level 3 set)...

**Step 1.** Press the **MENU** button.

The following front panel prompt is displayed.

PAS?

**Step 2.** Enter the *current Password* and press **SELECT** to display the Main Menu. (For security, a default character is substituted for each number pressed.)

#### To set the Baud Rate (for external remote operation)...

**Step 1.** Move to **Baud Rate** and press **SELECT** to display available settings [600, 1200, 2400, 4800 or 9600 baud]. The default setting is 9600.

**Step 2.** When the *desired setting* is displayed on-screen, move to **Exit** and press **SELECT**, or press 1 and then press **SELECT** to change the current setting. A pop-up menu displays *Save options*.

**Step 3.** Press 1 to save the new setting (YES), or follow the on-screen instructions, as required.

**Available options:** Press 1 to save the new settings (Yes), or press 2 to discard all changes (No), or press 3 to cancel the operation (Cancel).

Repeat this action to change to another baud rate. If you are unsure about which baud rate to use, contact your dealer/reseller, or local service provider.

## ...About the Aspect Ratio

The Aspect Ratio setting displayed at the User Setup menu is preset at the factory to Normal for viewing programming broadcast in 4 X 3 format on your TV monitor, and cannot be changed. If enabled at the uplink, a Wide Aspect Ratio setting lets you view programming broadcast in 16 X 9 format on your TV monitor. For more information, contact your dealer/reseller, or local service provider.

## ...About the local time

Current day, date and time information is displayed at the top of each menu. Time information is normally broadcast as part of the transmitted digital signal, and is usually the broadcaster local time relative to GMT<sup>1</sup>. If the current broadcast time is not your local time, you must change this time setting. Time information is displayed in the following format.

Day 00/00/00 00:00AM

---

<sup>1</sup> Greenwich Mean Time

### To set the Local Time...

- Step 1.** Move to **Local Time** and press SELECT to replace the current setting.
- Step 2.** Press the  arrow button to advance forward or backward from the current time setting in one-half (½) hour increments over a 24-hour period (12:00 AM through 11:59 PM). The default setting is 12:00 AM.

### To set the Video Standard...

- Step 1.** Move to **Video Standard** and press SELECT to display available settings [AUTO, NTSC, PAL-B, PAL-M OR PAL-N]. The default setting is AUTO.
- Step 2.** When the desired setting is displayed on-screen, move to Exit and press SELECT, or press 1 and then press SELECT to change the current setting. A pop-up menu displays Save options.
- Step 3.** Press 1 to save the new setting (YES), or follow the on-screen instructions, as required.

**Available options:** Press 1 to save the new settings (Yes), or press 2 to discard all changes (No), or press 3 to cancel the operation (Cancel).

Repeat this action to change the Video Standard. The Video Standard is initially preset to NTSC or PAL-B, depending on factory-installed options. Within your local network or jurisdiction, the local service provider may output a NTSC (525-line) or PAL-M (625-line) QPSK (downlink) signal. When set to AUTO, the receiver automatically displays video using the Video Standard associated with the QPSK (downlink) signal. When set to a specific Video Standard, the receiver displays video only when the current setting matches the Video Standard associated with the received signal. If the Video Standard (current setting) and do not match the received signal, an on-screen message displays to confirm that the current setting is invalid.

If you are unsure about which Video Standard to use, contact your dealer/reseller, or local service provider (see also "...About changing the Video Standard").



**IMPORTANT!** The current Video Standard setting is used by the receiver for correct display of the video (picture) only. The satellite receiver does not convert from one Video Standard to another, such as from NTSC (525-line) to PAL-B (625-line).

## ...About video subtitles

Your Headend Satellite Receiver can decode and display video subtitles on-screen if this information is broadcast as part of the encoded digital signal. Video subtitling is defined at the uplink via PowerVu System software, and can be set for display in a number of different languages, or can be disabled. When available, subtitle text appears at the bottom of the TV monitor screen and is synchronized with video programming. If the current subtitle language setting is incompatible, unavailable or does not match the subtitle information in the received digital signal, no subtitles are displayed. When you disable video subtitling (i.e., OFF) and exit to video from menus, a banner text message displays to confirm that no subtitles will display. For a list of available subtitle languages, see Table 7.

### To set the video Subtitles Language...

- Step 1.** Move to **Subtitles Lang.** and press SELECT to unlock the current setting.
- Step 2.** Press the  arrow button to advance forward or backward through the available settings (see Table 7). The default setting is OFF.
- Step 3.** When the desired setting is displayed on-screen, move to Exit and press SELECT, or press 1 and then press SELECT to change the current setting. A pop-up menu displays Save options.
- Step 4.** Press 1 to save the new setting (YES), or follow the on-screen instructions, as required.

**Available options:** Press 1 to save the new settings (Yes), or press 2 to discard all changes (No), or press 3 to cancel the operation (Cancel).

Repeat this action to change the Subtitles Language. If you are unsure about which language to use, contact your dealer/reseller, or local service provider.

To change the display characteristics of the subtitle language, refer to the Display Setup menu.

## ...About the Password

A unique Password (4-digit number) protects the current receiver settings against unauthorized changes. When changing the Password, record and keep this number in a secure location. The default password provided is...

Default Password 1234

It is recommended that you change the default Password to a different Password when the receiver is first installed, and periodically afterward, as required.

### To change the Password...

- Step 1.** Move to **Password** and press SELECT to display the Password prompt. A pop-up displays for entering the current password.
- Step 2.** Enter the current Password and press SELECT (for security, a default character is substituted for each button pressed). A pop-up displays for entering the new Password.
- Step 3.** Enter the new Password and press SELECT (any number from 0000 through 9999 is valid). A pop-up displays for confirming the new Password.
- Step 4.** Enter the new Password again and press SELECT. A pop-up displays to confirm that the new Password is ready to use.
- Step 5.** Repeat this action to change the current Password. If you make an error or press the wrong button when entering the Password, press the  $\leftarrow/\rightarrow$  arrow buttons to cancel input, and start again. If the Password is lost or is unavailable, contact your dealer/reseller or local service provider for assistance.

---

<sup>1</sup> Displays subtitle text in the selected language (from a pre-defined language group)

<sup>2</sup> Other languages (defined at uplink) may also be available for selection, depending on your network or jurisdiction

Table 7. Available video subtitle languages

Language	Language	Language
Arabic	Hebrew	Russian
Batak	Hindi	Sanskrit
Bengali	Hungarian	Serbian
Bulgarian	Indonesian	Sinhalese
Chinese	Irish	Spanish
Czech	Italian	Swedish
Dutch	Japanese	Tai
English	Korean	Tamil
Finnish	Malay	Thai
French	Multiple <sup>1</sup>	Ukrainian
Gaelic	Polish	Vietnamese
German	Portuguese	Undefined 1, 2, 3, 4, 5 and 6 <sup>2</sup>
Greek	Romanian	OFF (Disabled)

## ...About factory defaults

The Factory Reset option is used for resetting the receiver to factory default settings, including the Password. When activated, the current receiver settings are replaced by the default settings (see Table 8). After the factory defaults are restored, you can make any changes, as required. Current receiver settings can be replaced at any time.

### To restore the factory default settings...

- Move to **Factory Reset** and press SELECT. A pop-up menu displays available options (see Table 8).

### After selecting the Factory Reset option you can...

- Restore factory defaults:** Press 1 to restore the factory defaults (YES)
- Cancel:** Press 2 to cancel the operation (NO).

If no Remote Control is available, you can perform the these functions using the following front panel buttons.

- ❑ **Restore factory defaults:** Press and hold down both the ← and → arrow buttons simultaneously to restore the factory defaults (YES)
- ❑ **Cancel:** Press and hold down both the ↑ and ↓ arrow buttons simultaneously to cancel the operation (NO)

## ...About the IR Remote Control

The IR Remote option is used for enabling or disabling Remote Control capability. When enabled (ON), you can operate the receiver using Remote Control or front panel buttons. When disabled (OFF), you can only use the front panel buttons to operate the receiver (no response to any Remote Control buttons pressed). You can enable or disable Remote Control operation at any time.

The IR Remote Control is not supplied with the Headend Satellite Receiver, but can be purchased separately (specify S-A part #760-216). To order, contact your dealer/reseller or local service provider, or your local Scientific-Atlanta Customer Support Center (see “Appendix D Customer information”).

### To enable or disable Remote Control operation...

**Step 1.** Move to **IR Remote** and press SELECT to change the current setting (Enabled or Disabled). The default setting is Enabled.  
A pop-up menu displays available options (see Table 8).

**Step 2.** Press 1 to save the new setting (YES).

**Available options:** Press 1 to save the new settings (Yes), or press 2 to discard all changes (No), or press 3 to cancel the operation (Cancel).

Table 8. Factory default settings

	Option	Menu	Default setting
1.	Frequency Mode	Receiver Setup	L-Band/1
2.	Frequency	Receiver Setup	950 MHz
3.	Local Oscillator #1	Receiver Setup	9.750 GHz
4.	Local Oscillator #2	Receiver Setup	10.600 GHz
5.	Crossover	Receiver Setup	11.700 GHz
6.	Polarization	Receiver Setup	H (Horizontal)
7.	FEC Rate	Receiver Setup	7/8
8.	Symbol Rate	Receiver Setup	28.3465 Msymbols/sec.
9.	Network ID	Receiver Setup	1
10.	Lock Level	User Setup	0
11.	Bouquet ID	User Setup	0
12.	TV Audio	User Setup	Left + Right
13.	Baud Rate	User Setup	9600
14.	Aspect Ratio	User Setup	Normal
15.	Local Time	User Setup	12:00 AM
16.	IR Remote	User Setup	Disabled (OFF)
17.	Date Format	User Setup	US
18.	Video Standard	User Setup	AUTO
19.	Subtitles Language	User Setup	OFF
20.	Password	User Setup	1 2 3 4
21.	Search Mode	Search Setup	OFF
22.	Search Type	Search Setup	Frequency
23.	Lower Range	Search Setup	950 MHz
24.	Upper Range	Search Setup	2150 MHz
25.	IQ Select	Search Setup	Automatic

# Search Setup menu

Automated signal search options are available from the Search Setup menu for setting up your Headend Satellite Receiver (see also “Receiver Setup menu”).

To display the Search Setup menu...

- Step 1. Display the Main Menu (Figure 5).
- Step 2. Move to Receiver Status and press SELECT.
- Step 3. Move to Receiver Setup and press SELECT.
- Step 4. Move to Search Setup and press SELECT.

**Available options:** Move to Exit and press SELECT (or press 1 and then SELECT) to return to the previous menu.

You can view or change the current setup. Your dealer/reseller or local service provider can advise you about what receiver settings you may need to change. The following Search setup information is displayed on-screen.

- Search Mode
- Search Type
- Lower Range
- Upper Range
- I/Q Select

## ...About the Search option

Searching for a signal with the “Search” option is used for restoring normal receiver operation if the received signal is interrupted or lost, or is changed by the local broadcast satellite services provider.

A signal search is enabled by setting the Search option to ON at the Search Setup menu, and is activated automatically only if the carrier signal is interrupted or lost for more than 20 seconds (with menus not displayed). If the lost carrier signal is recovered within 20 seconds, the receiver will attempt to synchronize with the last locked channel. If unavailable, the “NO CHANNEL” banner is displayed. If the

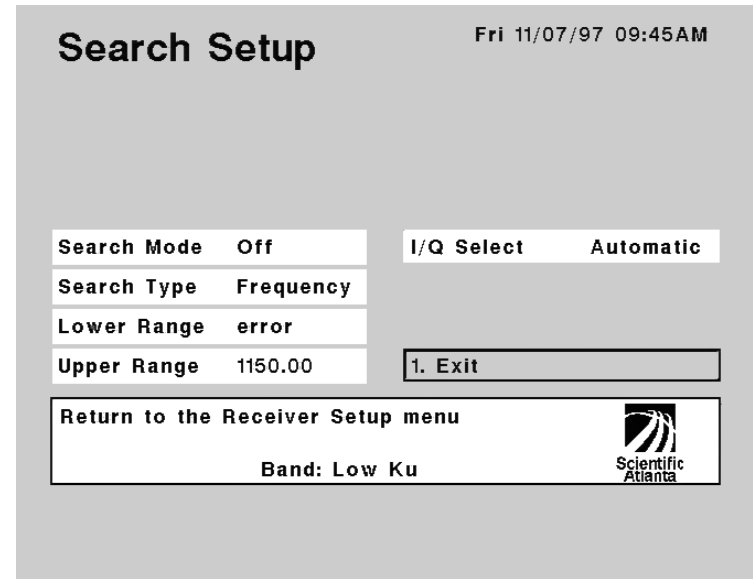

Figure 14. Search Setup menu display

lost carrier signal is not recovered within this time, a signal search is activated automatically.

Once activated, the receiver begins searching for a signal associated with the current Network ID. When a possible match is found, the search is temporarily interrupted while the receiver attempts to synchronize with the found signal. If synchronization is successful, the signal status is displayed on-screen. Settings can be saved, as required while in the Search Setup menu before exiting to video (current channel). If receiver synchronization cannot take place, the signal is discarded and the signal search is automatically resumed.

If no signal is found, the signal search continues indefinitely, and must be manually terminated. A signal search can also be manually terminated, or interrupted and resumed with different settings. To disable the search, set the Search to OFF. A search is also terminated automatically if the current channel is changed, or if the MENU button is pressed (see also “...About the Find option” and “...About the Signal State”).

## ...About other Search Setup options

Signal searches are constrained or limited by the current Search Type and the boundary settings for the Lower and Upper Range. When searching for a signal, the receiver uses the Search Type as the primary search criteria. For example, if the FEC Rate is set as the Search Type, only signals that match the current FEC Rate (set at the Receiver Setup menu) within the current Lower/Upper Range frequency boundaries are examined for a possible match. Signals associated with all other FEC Rates are ignored (see also "...About I/Q signal inversion").

### To set the Search Mode...

- Step 1.** Move to **Search Mode** and press SELECT to display available settings (ON or OFF). The default setting is OFF.
- Step 2.** When the desired setting is displayed on-screen, move to Exit and press SELECT, or press 1 and then press SELECT to change the current setting. A pop-up menu displays Save options.
- Step 3.** Press 1 to save the new setting (YES), or follow the on-screen instructions, as required.

**Available options:** Press 1 to save the new settings (Yes), or press 2 to discard all changes (No), or press 3 to cancel the operation (Cancel).

Setting the Search Mode to ON enables the signal search for automatic activation. You can disable the signal search option by setting the Search Mode to OFF.

### To set the Search Type...

- Step 1.** Move to **Search Type** and press SELECT to display available settings (see Table 9). The default setting is Frequency.
- Step 2.** When the desired setting is displayed on-screen, move to Exit and press SELECT, or press 1 and then press SELECT to change the current setting. A pop-up menu displays Save options.
- Step 3.** Press 1 to save the new setting (YES), or follow the on-screen instructions, as required.

**Available options:** Press 1 to save the new settings (Yes), or press 2 to discard all changes (No), or press 3 to cancel the operation (Cancel).

Table 9. Available Search Type options

Option	Description
FEC Rate	Search by FEC Rate
Frequency	Search by Frequency

Repeat the above action to change the Search Type. If you are unsure about which Search Type to use for best results, contact your dealer/reseller, or local service provider.

### To set the Lower and Upper frequency ranges for the search...

- Step 1.** (a) Move to **Lower Range** and press SELECT to replace the current setting. (b) Enter a valid frequency and then press SELECT. You can also press the **↑/↓** arrow buttons to display available settings (frequencies are displayed in 250 kHz steps from 950 through 2150 MHz). The default setting is 950 MHz.
- Step 2.** (a) Move to **Upper Range** and press SELECT to replace the current setting. (b) Enter a valid frequency and then press SELECT. You can also press the **↑/↓** arrow buttons to display available settings (frequencies are displayed in 250 kHz steps from 950 through 2150 MHz). The default setting is 2150 MHz.
- Step 3.** When the desired settings are displayed on-screen, move to Exit and press SELECT, or press 1 and then press SELECT to change the current settings. A pop-up menu displays Save options.
- Step 4.** Press 1 to save the new setting (YES), or follow the on-screen instructions, as required.

**Available options:** Press 1 to save the new settings (Yes), or press 2 to discard all changes (No), or press 3 to cancel the operation (Cancel).

Repeat this action to change to another frequency. If you are unsure about which frequencies to use, contact your dealer/reseller, or local service provider.

## ...About I/Q signal inversion

The I/Q Select function provides automatic or manual tracking of inverted and non-inverted digital QPSK signals. When set to Automatic, the I/Q Select function automatically tracks the received digital signal and inverts the signal, as required. When set to Inverted, the received digital signal is always inverted. Conversely, when set to Non-Inverted, the received digital signal is never inverted. The I/Q Select function is normally set to Automatic. The I/Q Select Inverted and Non-Inverted settings can be used to automatically reject unwanted signals.

### To set I/Q signal inversion...

- Step 1.** Move to **I/Q Select** and press **SELECT** to display available settings (Automatic, Inverted and Non-Inv). The default setting is Automatic.
- Step 2.** When the desired setting is displayed on-screen, move to **Exit** and press **SELECT**, or press **1** and then press **SELECT** to change the current setting. A pop-up menu displays **Save options**.
- Step 3.** Press **1** to save the new setting (**YES**), or follow the on-screen instructions, as required.

**Available options:** Press **1** to save the new settings (**Yes**), or press **2** to discard all changes (**No**), or press **3** to cancel the operation (**Cancel**).

Repeat the above action to change the I/Q Select setting. Unless otherwise recommended, I/Q Select should normally be set to Automatic (default). If you are unsure about which setting to use, contact your dealer/reseller, or local service provider. For a list of default receiver settings, see Table 8.



# Receiver Status menu

Information about the current receiver setup and about current receiver operating conditions is available from the Receiver Status menu, including ADP count. The current setup is also affected by your LNB antenna (dish) installation.

To display the Receiver Status menu...

**Step 1.** Display the Main Menu (Figure 5).

**Step 2.** Move to **Receiver Status** and press SELECT.

**Available options:** Move to Exit and press SELECT (or press 1 and then SELECT) to return to the previous menu. You can also select USER SETUP (or press 2 and then SELECT) to display the User Setup menu, or select RECEIVER SETUP (or press 3 and then SELECT) to display the Receiver Setup menu, or select CONFIGURATION (or press 4 and then SELECT) to display the Configuration menu.

You can view information about the current setup. Your dealer/reseller or local service provider can advise you about what receiver settings you may need to change. The following available satellite broadcast services information is displayed on-screen.

- Network ID
- Address
- Smart Card
- Signal Strength
- Signal Quality
- Signal State
- ADP (enc)
- ADP (non-enc)

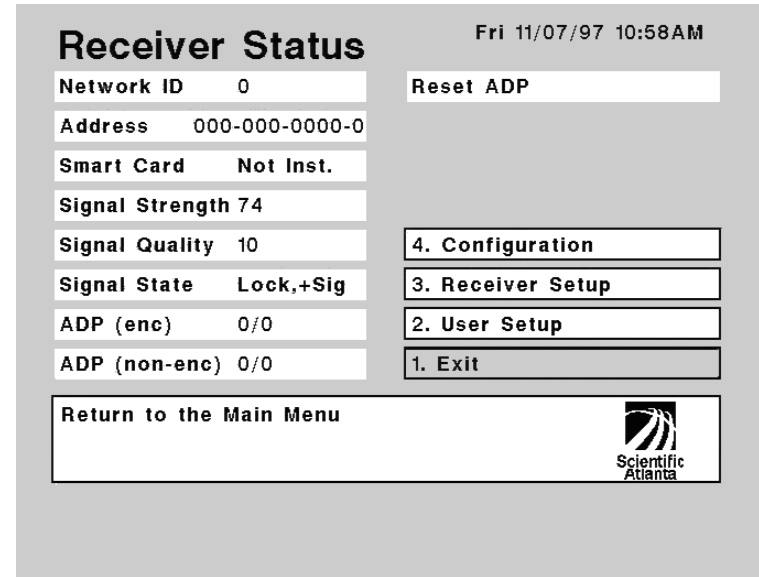

Figure15. Receiver Status menu display

## ...About the ADP count

The encrypted and non-encrypted Address Data Packet (ADP) count is continuously monitored by the receiver. The information displayed on-screen for each packet type indicates how much of the transmitted packet information is being accurately received and processed by the receiver. Under ideal conditions, both of the displayed figures are (nearly) identical. To assist with monitoring your receiver's performance, you can clear or reset the ADP count to zero (0) at any time using the Reset ADP option. The ADP count is also reset each time the receiver is switched ON.

To reset the ADP count...

**Step 1.** Move to **Reset ADP** and press SELECT.  
The ADP count is reset to zero (0).

Repeat the above actions to reset the ADP count.

## Network ID...

The Network ID display is the current Network ID. This number must be correctly set at the Receiver Setup menu to match the Network ID associated with the uplink signal. Loss of service will result if the receiver Network ID does not match the uplink signal Network ID information (see also "...About the Network ID").

## Address...

The decoder user address display is provided externally, and distinguishes your receiver from all other receivers within the network.

## Smart Card...

The Smart Card display indicates whether the Smart Card external security device is installed or not installed (see Figure 4). If your receiver includes a Smart Card interface, the device OSE<sup>1</sup> version identification number is displayed at the Configuration menu if a Smart Card is used.

## Signal Strength...

The Signal Strength display is continuously updated to indicate the relative strength of the received QPSK digital signal. The Signal Strength (displayed on a scale from 00 through 99) is associated with the signal input level. Signal Strength is also displayed at the Receiver Setup menu, and graphically at the Dish Pointing menu (see also "...About Signal Strength and Signal Quality").

## Signal Quality...

The Signal Quality display is continuously updated to indicate the relative quality of the received QPSK digital signal. The Signal Quality (displayed on a scale from 0 through 9) is associated with the Bit Error Rate, and is a measure of how much of the original signal information is being received. Signal Quality is also displayed at the Receiver Setup menu, and graphically at the Dish Pointing menu (see also "...About Signal Strength and Signal Quality").

## Signal State...

The Signal State display is continuously updated to indicate that the receiver is synchronized with the received LNB signal (confirmed by the "Lock, Sig" status display), or to indicate loss of signal synchronization (confirmed by the "Lock, No Sig" status). If the receiver is able to synchronize to a carrier frequency only and no MPEG stream is present or is recognized, the "Lock, No Sig" status is displayed, and the Signal indicator LED is OFF. If no digital carrier signal is detected, the "No Lock" status is displayed, and the Signal indicator LED is also OFF. If a signal search activated using the "Find" option is in progress, the "Searching" status is displayed (see also "...About the Find option" and "Search Setup menu"). Signal State is also displayed at the Receiver Setup menu, and at the Dish Pointing menu (see also "...About the Signal State").

---

<sup>1</sup> Outside Security Element

# Available Services menu

Information about available satellite broadcast services and the current setup is available from the Available Services menu. These services are authorized through your dealer/reseller or local service provider. The current setup is also affected by your LNB antenna (dish) installation.

To display the Available Services menu...

**Step 1.** Display the Main Menu (Figure 5).

**Step 2.** Move to **Available Services** and press SELECT.

**Available options:** Move to Exit and press SELECT (or press 1 and then SELECT) to return to the previous menu.

You can view information about the current setup, and/or change the current channel. The following available satellite broadcast services information is displayed on-screen.

- Video (PID)<sup>1</sup>
- Audio (PID)
- LS Data (PID)<sup>2</sup>
- CONTROL (control pins status)
- VBI (PID)<sup>3</sup>
- Download (PID)
- Channel (current channel number)
- Encryption (status)
- Scrambling (status)
- Authorization (status)

---

<sup>1</sup> Packet ID

<sup>2</sup> Low Speed Data

<sup>3</sup> Vertical Blanking Interval

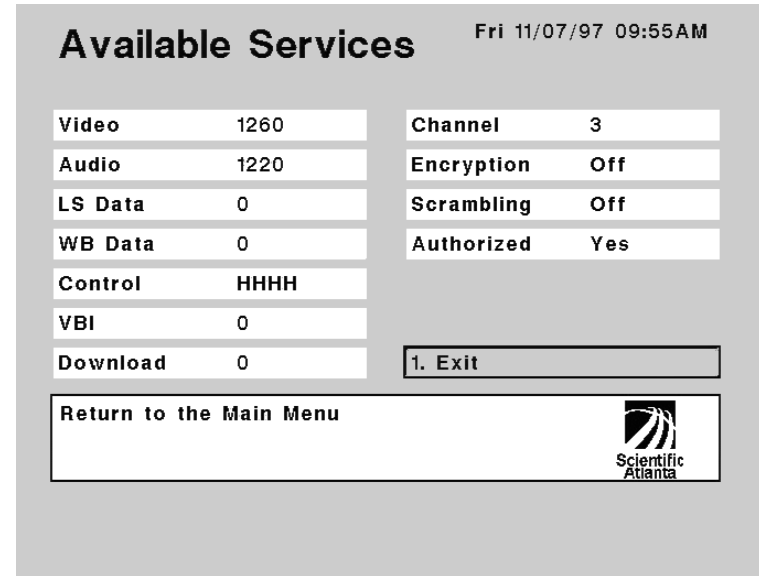

Figure16. Available Services menu display

## ...About subscriber services

Subscriber uplink services made available to your Headend Satellite Receiver are associated with virtual channels. These channels can include video, audio and/or data services. All authorized virtual channel services are provided via PowerVu System software and broadcast facility equipment, and are decoded by the receiver using the current receiver setup. You can view available subscriber services information independently (i.e., for each virtual channel) at the Available Services menu. If subscriber services are deauthorized, or if available services exclude one or more virtual channels, an on-screen message is substituted for the virtual channel display and the Authorized field displays “No” to indicate that no uplink service authorization key is being received.

If EXPANSION PORT control pins are being used for remote receiver operation via Remote Control commands, the status of each pin is displayed at the Control field. For example, if all four control pins are set to the open collector state (i.e., High), the Control field displays “HHHH”. For more information about the EXPANSION PORT, see “Connecting your system” (see also “Appendix C Serial Remote Control Command Set”).

For more information about on-screen messages, see “Appendix B Troubleshooting”.

## **...About the current channel**

When you navigate to menus from video, the information displayed is associated with the current (video) channel, which is also displayed on-screen at the Available Services menu. If no changes have been made to the current setup, you are automatically returned to the same channel when you exit to video. If any changes have been made at the Receiver Setup menu only, exiting to video from menus after saving changes is always preceded by the Installer Channel banner display (i.e., channel 0). Note that changes made at any other menu permit direct return to the previously-watched channel. For more information about the installer channel, see “Setting up the receive”.

### **To change the current channel...**

**Step 1.** Move to **Channel** and press **SELECT** to clear the display field.

**Step 2.** Enter a valid channel number using the numbered front panel buttons and then press **SELECT**.

Repeat the above actions to change the current channel. When you exit to video, the virtual channel you set is displayed.

# Dish Pointing menu

Information about the strength and quality of the incoming signal obtained via your satellite LNB antenna (dish) installation and current receiver setup is available from the Dish Pointing menu graph display.

To display the Dish Pointing menu...

**Step 1.** Display the Main Menu (see Figure 5).

**Step 2.** Move to Dish Pointing and press SELECT.

**Available options:** Move to Exit and press SELECT (or press 1 and then SELECT) to return to the previous menu.

You can view information about the current setup. Two independent bar graphs provide continuous display of Signal Strength and Signal Quality. Signal Strength and Signal Quality information is also displayed numerically at the Receiver Status and Receiver Setup menus (see “Receiver Status menu” and “Receiver Setup menu”).

## ...About Signal Strength and Signal Quality

Your Headend Satellite Receiver actively monitors and updates the strength and quality characteristics of the incoming signal as it is decoded, and displays this information dynamically using two (2) bar graphs. The Signal Strength (displayed on a scale from 0 through 99) is associated with the Symbol Rate and signal input level. The Signal Quality (displayed on a scale from 0 through 9) is associated with the Bit Error Rate, and is a measure of how much of the original signal information is being received.

Certain receiver settings can cause signal loss or degradation which can compromise video or audio information, or data. The effect of any changes you make to your satellite LNB antenna installation is immediately displayed on the bar graphs. Signal Strength and Signal Quality can also be affected by changes at the signal source, and/or by adverse environmental or terrestrial conditions. Taken in combination, certain receiver settings and signal conditions can cause the Signal Strength and Signal Quality (values) to increase or decrease accordingly.

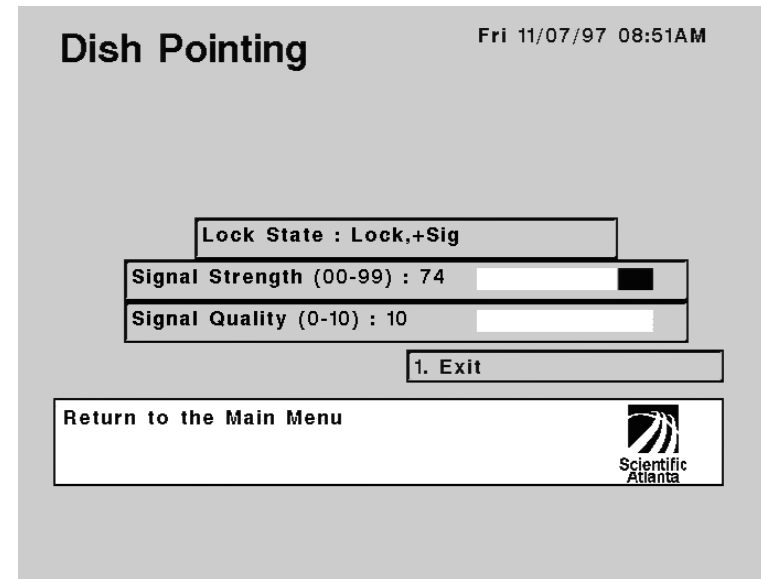

Figure17. Dish Pointing menu display

Temporary, solar-related electromagnetic disturbances occur every year during the spring and autumn months. These disturbances usually persist for several minutes a day for approximately one week during these periods. Your service provider will advise you about channels that may be adversely affected. For troubleshooting information, see “Appendix B Troubleshooting”.

To verify your satellite LNB antenna installation or improve signal reception, refer to your antenna equipment installation manual, or contact your dealer or service provider.

# Configuration menu

Information about the currently installed receiver operating software and hardware is available from the Configuration menu.

To display the Configuration menu...

**Step 1.** Display the **Main Menu** (Figure 5).

**Step 2.** Move to **Receiver Status** and press SELECT.

**Step 3.** Move to **Configuration** and press SELECT.

**Available options:** Move to Exit and press SELECT (or press 1 and then SELECT) to return to the previous menu.

You can view detailed information about the installed receiver software. The following receiver configuration information is displayed.

- App
- Download
- Boot
- IOP
- ISE
- OSE

## Application software version...

The App display identifies the version number of the receiver application software. Receiver application software can be upgraded remotely (i.e., over-the-air) via PowerVu System software control, or locally via Remote Control Commands (via the EXPANSION PORT).

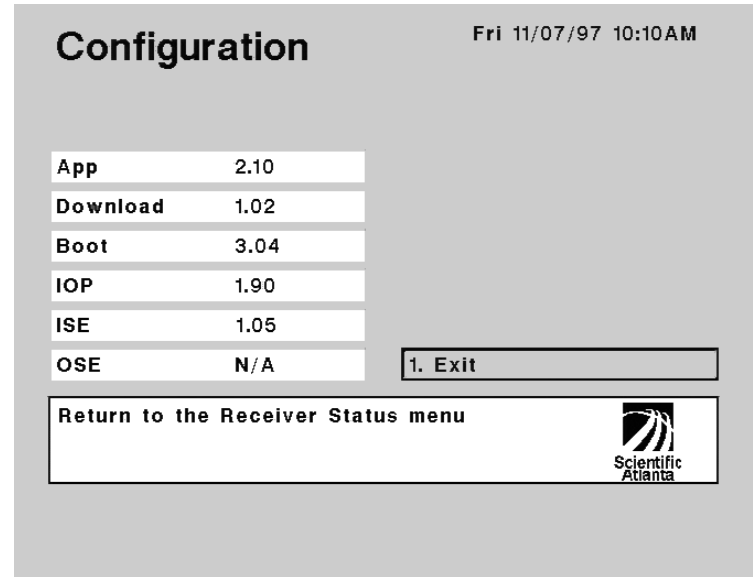

Figure18. Configuration menu display

## Download software version...

The Download display identifies the version number of the receiver Download software. Remote receiver application software downloads performed over-the-air via PowerVu System software are executed using the Download software.

## Boot software version...

The Boot display identifies the version number of the receiver Boot (or startup) software. The Boot software is executed each time the receiver is restarted.

## IOP software version...

The IOP display identifies the version number of the receiver IOP (Input/Output Processor) software. The IOP software controls the operation of all front panel buttons and menu (softkey) functions.

**ISE software version...**

The ISE display identifies the version number of the receiver ISE (Internal Security Element) software. The ISE software controls the operation of all internal data security functions.

**OSE software version...**

The OSE display identifies the version number of the receiver OSE (Outside Security Element) software, if installed. The OSE software is associated with the Smart Card<sup>1</sup> external security device.

---

<sup>1</sup> Smart Card operation is currently unavailable

# Network Presets menu

This menu lets you configure and store sets of network parameters to be used to define as many as 24 network signals. Each configuration set is called a “preset” and is uniquely identified by a preset number (0 to 23).

If you have only one network preset to configure, you could use the Receiver Setup menu instead of this menu. (See also “Receiver Setup menu”.) However, to configure two or more network presets, you must use the Network Presets menu. In a typical application, you would not need to use the Network Presets menu.

Most of the functions needed to set up your Headend Satellite Receiver are available from the Network Presets menu. You can view or change the current setup.

## To display the Network Presets menu...

- Step 1. Display the Main Menu (see Figure 5).
- Step 2. Move to **Receiver Status** and press SELECT.
- Step 3. Move to **User Setup** and press SELECT.
- Step 4. Move to **Network Presets** and press SELECT.

**Available options:** Move to Exit and press SELECT (or press 1 and then SELECT) to return to the previous menu.

## ...General rules for using the Network Presets menu

- The settings in fields Freq Mode, L.O. Freq #1, L.O. Freq #2, and Crossover can be changed only at the Receiver Setup menu. These settings are used for all network presets. If you set L.O. Freq #1 to a value less than 8 GHz, it is used as a C-Band L.O. frequency for all network presets. If you set L.O. Freq #1 to a value greater than 8 GHz, it is used as a low Ku-Band L.O. frequency for all network presets
- If you use Ku-Band, you must define L.O. Freq #1, L.O. Freq #2, and Crossover (at the Receiver Setup menu).
- If your LNB has only one local oscillator, set both L.O.s to the same local oscillator frequency.

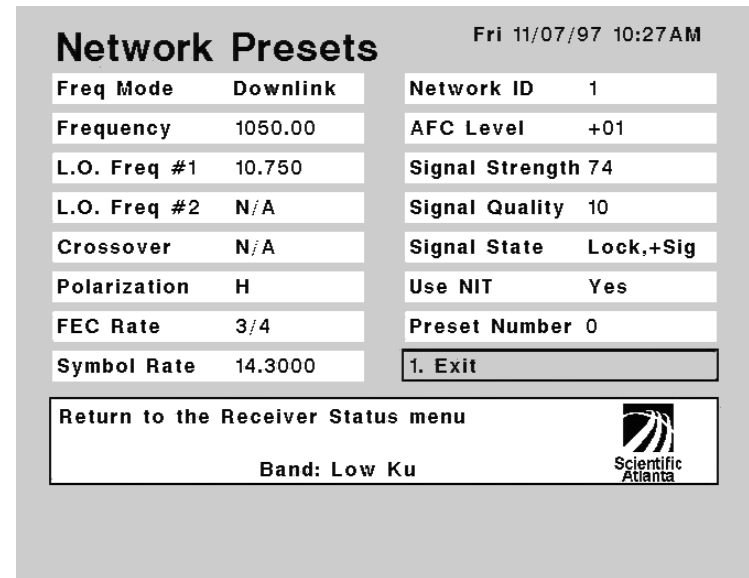

Figure 19. Network Presets menu display

- Whenever you change a setting that is common to both the Receiver Setup menu and the Network Presets menu, the setting is changed accordingly in both menus.
- The current band you are using at the Network Presets menu depends on the frequency defined. Any frequency between 0 and 8 GHz is C-Band. Otherwise, the frequency is KU-band.
- When you switch between presets, the frequency mode in the Receiver Setup menu changes to downlink.
- For those familiar with L-Band frequencies, the Downlink frequency can be determined according to the following formula:

$$\text{Downlink freq.} = \text{L-Band freq.} + \text{L.O. freq.}$$

## To set the Local Oscillator and Crossover frequencies...

- Step 1. Go to the Receiver Setup menu.
- Step 2. Set field Freq Mode to Downlink.



**Step 3.** If you want to use C-Band, set L.O. Freq #1 to the desired C-Band frequency (0 to 8 GHz) at the Receiver Setup menu, and then save the setting. All network presets with downlink frequencies ranging from 0 to 8 GHz will use the L.O. frequency defined in this step.

**Step 4.** If you want to use Ku-Band and if your LNB has two local oscillators set L.O. Freq #1, L.O. Freq #2, and Crossover for Ku-Band, and then save the settings.

If you want to use Ku-Band and if your LNB has only one local oscillator set both L.O. Freq #1 and L.O. Freq #2 to the same setting as is applicable to your LNB.

All network presets with downlink frequencies greater than 8 GHz will use the L.O. frequencies defined in this step.

**Step 5.** Go back to the Network Presets menu to configure the rest of the settings.

#### To set the operating Frequency...

**Step 1.** Be sure you have configured the Local Oscillator and Crossover frequencies as described above.

**Step 2.** Move to **Frequency** and press SELECT to replace the current setting.

**Step 3.** Enter a valid frequency and then press SELECT. You can also press the  $\uparrow/\downarrow$  arrow buttons to display available settings from 0 GHz through 15 GHz (Downlink) in 250 kHz steps. The default setting for Downlink is 10.7 GHz.

**Step 4.** When the desired setting is displayed on-screen, move to Exit and press SELECT, or press 1 and then press SELECT to change the current setting. A pop-up menu displays Save options.

**Step 5.** Press 1 to save the new setting (YES), or follow the on-screen instructions, as required.

**Available options:** Press 1 to save the new settings (Yes), or press 2 to discard all changes (No), or press 3 to cancel the operation (Cancel).

Repeat this action to change to another frequency. A valid operating Frequency is always required (i.e., for setting the Downlink frequency).

#### To set the antenna LNB polarization...

**Step 1.** Be sure you have configured the Local Oscillator and Crossover frequencies as described above.

**Step 2.** Move to **Polarization** and press SELECT to display available settings (H [Horizontal], H (Fixed), V [Vertical]) or V (Fixed). The default setting is H (Horizontal).

**Step 3.** When the desired setting is displayed on-screen, move to Exit and press SELECT, or press 1 and then press SELECT to change the current setting. A pop-up menu displays Save options.

**Step 4.** Press 1 to save the new setting (YES), or follow the on-screen instructions, as required.

**Available options:** Press 1 to save the new settings (Yes), or press 2 to discard all changes (No), or press 3 to cancel the operation (Cancel).

Repeat this action to change the polarization. When a Horizontal polarization is set, a 19 volt DC signal is output via the receiver rear panel SATELLITE connector. When a Vertical polarization is set, a 13 volt DC signal is output via this connector. Observe the effect of the polarization change by checking the displayed relative Signal Strength and Signal Quality values (see Figure 12). Higher numbers are better. If you are unsure about which polarization to use, contact your dealer/reseller, or local service provider.

#### To set the FEC rate...

**Step 1.** Be sure you have configured the Local Oscillator and Crossover frequencies as described above.

**Step 2.** Move to **FEC Rate** and press SELECT to display available settings (1/2, 2/3, 3/4, 5/6, or 7/8). The default setting is 7/8.

**Step 3.** When the desired setting is displayed on-screen, move to Exit and press SELECT, or press 1 and then press SELECT to change the current setting. A pop-up menu displays Save options.

**Step 4.** Press 1 to save the new setting (YES), or follow the on-screen instructions, as required.

**Available options:** Press 1 to save the new settings (Yes), or press 2 to discard all changes (No), or press 3 to cancel the operation (Cancel).

Repeat this action to change the FEC Rate. The selected FEC Rate must match the FEC Rate associated with the transmitted signal. If you are unsure about which FEC rate to use, contact your dealer/reseller, or local service provider.

#### To set the Symbol Rate...

- Step 1.** Be sure you have configured the Local Oscillator and Crossover frequencies as described above.
- Step 2.** Move to **Symbol Rate** and press SELECT to replace the current setting.
- Step 3.** Enter a valid Symbol Rate using the numbered Remote Control buttons and then press SELECT. You can also press the  $\uparrow/\downarrow$  arrow buttons to display available settings (Symbol Rates are displayed from 3 MS/s through 30.8000 MS/s in 10 KS/s steps). The default setting is 28.3465 MS/s.
- Step 4.** When the desired setting is displayed on-screen, move to Exit and press SELECT, or press 1 and then press SELECT to change the current setting. A pop-up menu displays Save options.
- Step 5.** Press 1 to save the new setting (YES), or follow the on-screen instructions, as required.

**Available options:** Press 1 to save the new settings (Yes), or press 2 to discard all changes (No), or press 3 to cancel the operation (Cancel).

Repeat this action to change to another Symbol Rate. The selected Symbol Rate must match the Symbol Rate associated with the transmitted signal. If you are unsure about which Symbol Rate to use, contact your dealer/reseller, or local service provider.

#### To set the Network ID...

- Step 1.** Be sure you have configured the Local Oscillator and Crossover frequencies as described above.
- Step 2.** Enter a valid Network ID (number) and then press SELECT. You can also press the  $\uparrow/\downarrow$  arrow buttons to display available settings (numbers are displayed from 0 through 65535).
- Step 3.** When the desired setting is displayed on-screen, move to Exit and press SELECT, or press 1 and then press SELECT to change the current setting. A pop-up menu displays Save options.

- Step 4.** Press 1 to save the new setting (YES), or follow the on-screen instructions, as required.

**Available options:** Press 1 to save the new settings (Yes), or press 2 to discard all changes (No), or press 3 to cancel the operation (Cancel).

Repeat this action to change the Network ID (see also "...About the Network ID"). Changing the Network ID is normally required only when authorized subscriber services are changed, or when new or different subscriber services are made available (see Figure 12). If you are unsure about which Network ID to use, contact your dealer/reseller, or local service provider. Changing the Network ID may also require that you execute a signal search (see "Search Setup menu" and "...About the Find option").

#### To set the NIT...



NIT (Network Information Table) contains lists of channels and frequency plans used on the network. The NIT is transmitted from the uplink. In most cases, the NIT is needed and, therefore, the YES option should be selected. To find out whether or not you should use the NIT on your receiver, contact your service provider.

- Step 1.** Be sure you have configured the Local Oscillator and Crossover frequencies as described above.
- Step 2.** Move to **Use NIT** and press SELECT to switch between YES and NO.
- Step 3.** When the desired setting is displayed on-screen, move to Exit and press SELECT, or press 1 and then press SELECT to change the current setting. A pop-up menu displays Save options.
- Step 4.** Press 1 to save the new setting (YES), or follow the on-screen instructions, as required.

**Available options:** Press 1 to save the new settings (Yes), or press 2 to discard all changes (No), or press 3 to cancel the operation (Cancel).

#### To set or change the Preset Number...

- Step 1.** Be sure you have configured the Local Oscillator and Crossover frequencies as described above.
- Step 2.** Move to **Preset Number** and press SELECT to clear the current setting.

**Step 3.** Enter a valid Preset Number (0 to 23) and then press SELECT. You can also press the / arrow buttons to cycle through the valid range.

**Step 4.** When the desired setting is displayed on-screen, move to Exit and press SELECT, or press 1 and then press SELECT.  
A pop-up menu displays Save options.

**Step 5.** Press 1 to save the new setting (YES), or follow the on-screen instructions, as required.

**Available options:** Press 1 to save the new settings (Yes), or press 2 to discard all changes (No), or press 3 to cancel the operation (Cancel).

## ...About the Signal State

During normal operation, your receiver is synchronized with the received LNB signal (confirmed by the “Lock, Sig” status display). If the receiver is able to synchronize to a carrier frequency only and no MPEG stream is present or is recognized, the “Lock, No Sig” status is displayed, and the Signal indicator LED is OFF. If no digital carrier signal is detected, the “No Lock” status is displayed, and the Signal indicator LED is also OFF.

# Display Setup menu

This menu lets you select (a) the colour to be used for the menu background, (b) the colour to be used for the subtitling text and (c) the colour to be used for the subtitling shade (background),

## Menu background...

Menu background refers to the area over which menu fields are placed. Once you have selected a menu background colour, it is applied to all menu screens.

## Subtitling text...

Subtitling text is displayed on the lower portion of the video screen, if the option is enabled. The text will be displayed in the language selected in the User Setup menu.

## Subtitling shade (background)...

Subtitling shade refers to the area which is superimposed over the lower portion of the video to serve as a background for subtitling text.

## To display the Display Setup menu...

- Step 1.** Display the **Main Menu** (see Figure 5).
- Step 2.** Move to **Receiver Status** and press **SELECT**.
- Step 3.** Move to **User Setup** and press **SELECT**.
- Step 4.** Move to **Display Setup** and press **SELECT**.

**Available options:** Move to **Exit** and press **SELECT** (or press 1 and then **SELECT**) to return to the previous menu.

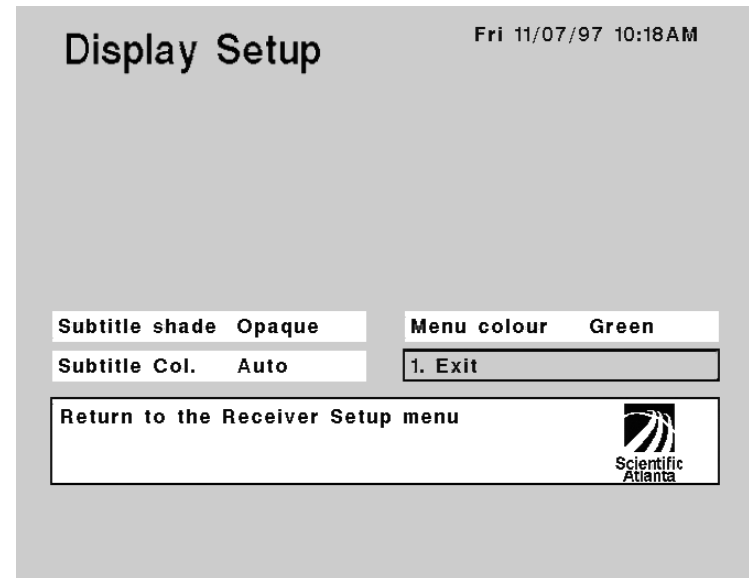

Figure 20. Display Setup menu display

## To change the menu background colour...

- Step 1.** Move to **Menu colour** and press **SELECT** to replace the current colour.
- Step 2.** When the desired colour is displayed on-screen, move to **Exit** and press **SELECT**, or press 1 and then press **SELECT**.  
A pop-up menu displays **Save options**.

**Available options:** Press 1 to save the new settings (**Yes**), or press 2 to discard all changes (**No**), or press 3 to cancel the operation (**Cancel**).

## To change the subtitling colour...

- Step 1.** Move to **Subtitle col.** and press **SELECT** to replace the current setting. (If you choose **AUTO**, the colour used will be automatically chosen at the uplink.)
- Step 2.** When the desired setting is displayed in the field, move to **Exit** and press **SELECT**, or press 1 and then press **SELECT**.  
A pop-up menu displays **Save options**.

**Available options:** Press 1 to save the new settings (**Yes**), or press 2 to discard all changes (**No**), or press 3 to cancel the operation (**Cancel**).

**To change the subtitling shade (background) colour...**

**Step 1.** Move to Subtitle shade and press SELECT to replace the current setting. (See Table 10 for descriptions of settings.)

**Step 2.** When the desired setting is displayed in the field, move to Exit and press SELECT, or press 1 and then press SELECT.  
A pop-up menu displays Save options.

**Available options:** Press 1 to save the new settings (Yes), or press 2 to discard all changes (No), or press 3 to cancel the operation (Cancel).

**Table 10. Available Subtitling shade options**

Option	Description
Auto	Subtitling background will be chosen automatically at the uplink.
None	No background used. Subtitling text will be displayed directly on top of video.
Semi-trans	Subtitling background will partially obscure the video.
Opaque	Subtitling background will totally obscure the video.
Shadow	A drop shadow will be applied to the subtitling text. No other subtitling background will be used.



# Appendix A Specifications

This Appendix provides important information about your PowerVu Headend Satellite Receiver. Refer to this section for:

- Product features and specifications

The accompanying table lists standard features, available options and specifications information.

Table 11. Product specifications

System	Description
Modulation:	QPSK
Inner FEC:	Variable (1/2, 2/3, 3/4, 5/6 or 7/8)
Outer) FEC:	Reed Solomon, T=8
Transport:	MPEG 2
Tuner	Description
Tuner input level:	-30 dBm through -60 dBm per carrier
Frequency range:	950 MHz through 2150 MHz
Symbol Rate range:	3.0 to 30.8 Msymbols/s
Video Output	Description
Video decompression type:	MPEG 2
Video output level:	1.0 V p-p ± 10%
Frequency response:	Up to 5 MHz
Maximum video resolution :	704 x 576
Chroma-luma delay:	± 75 ns
Time line distortion:	3 % max.
Luminance non-linearity:	5 %
Differential gain:	5 % max.
Differential phase:	5 ° max.
Signal-To-Noise-Ratio:	≥ 56 dB
VBI line insertion:	Lines 10-22 (NTSC) fields 1 and 2 or PAL lines 7 -22

<b>Audio Outputs</b>	<b>Description</b>
1 Unbalanced stereo audio output:	2V RMS @ 10 K $\Omega$ max. output level
2 Balanced (adjustable) audio outputs Factory set for unity gain (0 dBm out for 0 dBm in):	Adjustable from $\pm 6$ dB providing a maximum output of +18 dBm into 600 $\Omega$ , <25 $\Omega$ output impedance
<b>Expansion Port</b>	<b>Description</b>
Low-Speed data:	RS-232 asynchronous data at rates of 300, 1200, 2400, 4800, 9600, 19200, and 38400 b/s
Four open-collector outputs:	For control of external devices
Serial Remote Control and monitoring outputs:	Rs-232 data at rates of 600, 1200, 2400, 4800 and 9600 b/s
<b>Environmental</b>	<b>Description</b>
Operating temperature:	32° F to 122° F (0° C to 50° C)
Storage temperature:	-40° F to 140° F (-40° C to 60° C)
Relative humidity:	5% to 95%, non-condensing
<b>Physical</b>	<b>Description</b>
Dimensions:	3.5 inches H X 19.0 inches W X 13.3 inches (8.9 cm H X 48.3 cm W X 64.5 cm D)
Chassis:	2U height for EIA standard (19 inch wide rack) mounting
Weight:	11.5 lbs. (5.22 kg) approx.
<b>Power Requirements</b>	<b>Description</b>
Voltage range:	100 VAC to 240 VAC $\pm$ 10 % nominal
Line frequency:	47 Hz to 63 Hz
Power consumption:	63W
LNB drive voltage (ON/OFF selectable):	13/19 VDC @ 500 mA max. (Optional: 15 VDC @ 500 mA max.)
<b>Connectors and Controls</b>	<b>Description</b>
SATELLITE (input):	F type
VIDEO (output):	BNC type
AUDIO, L & R, unbalanced (output):	2 (RCA type)
AUDIO, L & R, balanced (output):	L (Left +/-), R (Right +/-), and G (Gnd) terminal block
EXPANSION PORT:	25-pin D, female (Low-Speed data)
LNB PWR (drive voltage) ON/OFF:	Slide switch
Level control, L & R balanced (output):	Trimmer potentiometers



# Appendix B Troubleshooting

This Appendix provides important information about your PowerVu Headend Satellite Receiver. Refer to this section for:

- ❑ Product troubleshooting checklist
- ❑ Commonly-asked questions with answers

## Troubleshooting checklist

If you experience any problems operating your Headend Satellite Receiver, the following troubleshooting guide may help you to resolve your problem. Quite often, a loose cable connection or an incorrect receiver setting can cause loss of service, signal degradation, sound or picture problems. In most cases, these problems can be quickly resolved by following the tips and suggestions provided. Also included is a list of answers to some commonly asked questions.

Note that temporary, solar-related electromagnetic disturbances occur every year during the spring and autumn months. These disturbances usually persist for several minutes a day for approximately one week during this period. When they occur, your service provider will advise you about certain channels that may be adversely affected. If you are unable to resolve your problem after consulting this Troubleshooting checklist, contact your dealer/reseller or local service provider for assistance, or contact your local Scientific-Atlanta Customer Support Center.

Table 12. Troubleshooting checklist

	Problem	Possible Causes	Remedies
1.	Blank screen (TV switched on)	<ul style="list-style-type: none"><li>• Normal operation if receiver is not switched on</li></ul>	<ul style="list-style-type: none"><li>• Press the STANDBY button on the receiver front panel</li></ul>
2.	Incomplete or interrupted video recording	<ul style="list-style-type: none"><li>• Receiver manually switched off during VCR recording</li></ul>	<ul style="list-style-type: none"><li>• Do not switch the receiver off during a recording session</li></ul>
3.	Smart Card error reported	<ul style="list-style-type: none"><li>• Smart Card expired or card information damaged or erased</li></ul>	<ul style="list-style-type: none"><li>• Report problem to your dealer/reseller or local service provider</li></ul>
4.	Scrambled channel (not decoded)	<ul style="list-style-type: none"><li>• Smart Card expired, card not inserted or card information damaged or erased</li></ul>	<ul style="list-style-type: none"><li>• Check that the Smart Card is correctly inserted</li><li>• Check that your subscriber services are currently authorized (contact your local services provider)</li></ul>
5.	Cannot exit the on-screen display to the desired program or event	<ul style="list-style-type: none"><li>• You have not pressed the correct button required to make the selection</li></ul>	<ul style="list-style-type: none"><li>• See "Operating the receiver" for details</li></ul>
6.	Cannot access a password protected on-screen option	<ul style="list-style-type: none"><li>• You have not entered the correct password, or the password may be changed</li></ul>	<ul style="list-style-type: none"><li>• Check that you are using the correct password (if you've lost the password, or the password is unavailable, contact your dealer/reseller or local service provider for assistance)</li></ul>
7.	Cannot record a program on your VCR	<ul style="list-style-type: none"><li>• Your VCR is not properly connected (see "Connecting your system")</li><li>• You have attempted to record a copy-protected program or event (some programs are copy-protected at the discretion of the copy-right owner and may not record properly on your VCR)</li></ul>	<ul style="list-style-type: none"><li>• Check that your VCR is properly connected</li><li>• For information about Macrovision copy-protected programs or events, contact your dealer/reseller or local service provider</li></ul>

	<b>Problem</b>	<b>Possible Causes</b>	<b>Remedies</b>
<b>8.</b>	No TV signal present, poor picture quality (sparkles) or loss of picture (receiver is switched on)	<ul style="list-style-type: none"> <li>• Installation problem</li> <li>• Signal problem</li> <li>• Local heavy precipitation falling (normal operation will likely resume after the precipitation has stopped)</li> <li>• Smart Card not inserted</li> <li>• Subscriber services deauthorized</li> <li>• You have attempted to record a copy-protected program (some programs are copy-protected at the discretion of the copyright owner and may not record properly on your VCR)</li> </ul>	<ul style="list-style-type: none"> <li>• Check that all satellite/antenna/video and other cables are properly connected</li> <li>• Check that your satellite antenna (dish) is properly aligned</li> <li>• Check that the correct receiver installation settings are being used, that an adequate signal level is present and that receiver operating errors are being reported</li> <li>• Check that the video signal is being routed directly from the receiver, and not via your VCR equipment (some programming may be transmitted using Macrovision copy protection)</li> <li>• Check that the TV modulator selector switch (receiver rear panel) is set to the correct channel for receiving satellite signals via your TV tuner/converter</li> <li>• Check that your subscriber services are currently authorized</li> <li>• For information about Macrovision copy-protected programs or events, contact your dealer/reseller or local service provider</li> </ul>
<b>9.</b>	Poor reception	<ul style="list-style-type: none"> <li>• Your antenna, video and/or audio cables may be faulty or not properly connected</li> <li>• Your Headend Satellite Receiver is not setup to properly receive the satellite signal</li> <li>• Possible station trouble (the signal source for one or more channels (or all channels) is temporarily affected by technical transmission problems or a temporary solar disturbance)</li> <li>• Your satellite antenna (dish) may not be properly installed (dish/LNB alignment) or is not accurately aimed at the satellite signal transmission source</li> </ul>	<ul style="list-style-type: none"> <li>• Check the connections to and from the satellite antenna LNB, television antenna, and all video and audio cables (see "Connecting your system" for details)</li> <li>• A transmission problem or a temporary solar disturbance may be causing the poor reception (contact your service provider)</li> <li>• Check another channel or channels to compare signal reception</li> </ul>
<b>10.</b>	No picture, no sound	<ul style="list-style-type: none"> <li>• You have not turned your Headend Satellite Receiver on or the receiver is not properly connected to AC power</li> <li>• Your antenna, video and/or audio cables may be faulty or not properly connected</li> <li>• Possible station trouble (the signal source for one or more channels (or all channels) is temporarily affected by transmission problems or due to a temporary solar disturbance)</li> </ul>	<ul style="list-style-type: none"> <li>• Press the ON/STANDBY button on the receiver front panel</li> <li>• Check that your Headend Satellite Receiver is properly connected to AC/power</li> <li>• Check the connections to and from the satellite antenna LNB, television antenna, and all video and audio cables (see "Connecting your system" for details)</li> <li>• Check another channel or channels to compare signal reception</li> </ul>
<b>11.</b>	Picture OK, poor sound	<ul style="list-style-type: none"> <li>• You have muted the sound</li> </ul>	<ul style="list-style-type: none"> <li>• Check another channel or channels to compare signal reception</li> <li>• See the previous item in this table for details</li> </ul>
<b>12.</b>	Sound OK, poor picture		<ul style="list-style-type: none"> <li>• Check another channel or channels to compare signal reception</li> <li>• See the previous item in this table for details</li> </ul>

# Questions and answers

The following list of commonly-asked questions and answers may answer some questions or concerns you have about the operation of your Headend Satellite Receiver.

Questions	Answers
<b>Q</b> What happens if the receiver is unplugged, or disconnected from AC power?	<b>A</b> Your Headend Satellite Receiver may be deauthorized if not in use for an extended period of time. If this happens, contact your dealer/reseller or local service provider to reauthorize your satellite services.
<b>Q</b> If the system does not appear to be working properly, what can be done?	<b>A</b> Follow the troubleshooting tips and suggestions provided in this guide. If the problem persists, contact your dealer/reseller or local service provider.
<b>Q</b> Why must the TV monitor be tuned to a specific channel (RF modulator)?	<b>A</b> Your Headend Satellite Receiver provides a television signal to your TV tuner over a frequency that corresponds to specific channels, depending on which model you have (channels 1 or 2 for NTSC [Japan] standard, channels 3 or 4 for NTSC [M/US] standard or channels 28 through 47 for PAL standard). Your dealer/reseller or local service provider can identify the correct TV tuner and rear panel switch setting(s) to use.
<b>Q</b> Can other programming be received using the same satellite antenna (dish)?	<b>A</b> An antenna signal distribution system that includes a signal splitting or bypass feature lets you distribute or receive other satellite signals. To find out if your system includes this capability, contact your antenna installer, or your dealer/reseller or local service provider.
<b>Q</b> If there is more than one TV monitor available, can the Headend Satellite Receiver be used to watch different channels on each TV monitor?	<b>A</b> No. To do this requires a separate receiver for each TV monitor.
<b>Q</b> How can one know which channels are authorized for reception?	<b>A</b> If you are not authorized to receive a channel, it will not be available for viewing. For more information, contact your dealer/reseller or local service provider.



---

# Appendix C Serial Remote Control Command Set

This Appendix provides important information about your PowerVu Headend Satellite Receiver. Refer to this section for:

- ❑ *Serial Remote Control commands*

Your Headend Satellite Receiver is equipped for external remote operation and control using remote control commands via a PC/workstation or data terminal connection. This optional connection can be made at the receiver rear panel serial data port labeled EXPANSION PORT (see “Connecting your system”). Remote operating commands can be used in place of the user interface for remote receiver setup and monitoring.

General information about how remote commands are used is followed by detailed information about each command, including syntax and command options.

## Command protocol

Each of the remote control commands are executed using a unique protocol or rules. These rules control command syntax (i.e., how a command must be sent to the receiver) and how the receiver responds. Commands can only be interpreted by the receiver if upper case characters are used. When sending commands, observe the following.

- ❑ *Use only upper case ASCII characters*
- ❑ *All Remote Control commands begin with the characters “SA1”*
- ❑ *A command is executed only after a carriage return character is sent (i.e., the Enter or Return key is pressed)*

The following conventions are used for identifying the command options found in this Appendix.

- ❑ *Left and right parenthesis characters “{ }” and the forward slash character “/” are used to separate the command option(s) from the main command characters, and must not be entered*
- ❑ *The forward slash character “/” used to separate command options indicates that one of the available options must be specified, and must not be entered*

The following example shows correct command usage.

SA1VER<CR>

In the above example, the VER command causes the receiver model number to display only after the Enter key is pressed (i.e., carriage return [<CR>]). The command is valid only if the characters “VER” are used (i.e., “VER” is not a valid command, even though the characters are the same). If command or syntax is invalid, the receiver responds with “?”. If an internal overflow condition exists when executing a command, the receiver responds with “V”. Note that all Remote Control commands begin with the characters “SA1”.

## Command/Response messaging

A specific protocol is used for constructing and processing all remote control command and resulting response messages. Table 13 shows command frame and response frame information.

Table13. Command/Response frames

Command frame			
Byte	Length	Data	Description
1	1	"S"	Start character #1
2	1	"A"	Start character #2
3	1	"1-9" ";"	Unit Number (in chain) <sup>1</sup> Precedes next ASCII character (if more than 9 units in chain)
4	n		Command code and parameters
4 + n	1	<CR> <sup>2</sup>	End of message
Response frame			
1	1	<LF> <sup>3</sup>	Line Feed
2	n		Command Response
2 + n	1	<CR>	Carriage Return
3 + n	1	<LF>	Line Feed
4 + n	1	">"	Ready for next message

All transmitted command characters must be upper case ASCII. All characters are echoed by the receiver, except for the Unit Number (i.e., byte #3) which is decremented if greater than zero (0). This permits daisy-chaining two or more receivers from one serial port.

### Error responses

Table 14 shows command error and overrun error response frame information.

?

The command error message displays if the receiver cannot recognize the command, or if an internal microprocessor operating error or error condition exists.

<sup>1</sup> Decoder is addressed when first unit (1) received

<sup>2</sup> Carriage Return

<sup>3</sup> Line Feed

Table14. Command/Overrun errors

Command error frame			
Byte	Length	Data	Description
2	1	"?"	Command error response
Overrun error frame			
2	1	"&"	Overrun error response

&

The overrun error message displays if the receiver cannot process the command completely, and/or if the command becomes corrupted during transmission.

## Bit Error Rate (BER)

The BER command is available for polling the receiver to display the current Bit Error Rate of the decoded digital signal (errors per second). Observe the following syntax.

SAIBER

**BER** polls the receiver for the current Bit Error Rate (digital signal), where #.#E-# is the number is bit errors in a 1 million bit sample, expressed in scientific notation. The receiver responds by displaying the following.

BER=#.#E-#

## Channel

The Channel command is available for polling the receiver to display the current channel, or for changing the channel. Observe the following syntax.

SA1CH=###

**CH** polls the receiver for the current channel. **CH=###** changes the current channel. The receiver responds by displaying the following.

CH=###

### can be any virtual channel number from 0 through 500.

## Errors (Corrected)

The CE command is available for polling the receiver to display the current Corrected Error count, and for clearing or resetting the Corrected Error count. Observe the following syntax.

**SA1CE=0**

**CE** polls the receiver for the current Corrected Error count. **CE=0** clears or resets the current Corrected Error count. The receiver responds by displaying the following.

**CE=###**

**###** (0 through 65536) is the number of Corrected (Viterbi) Errors counted since the last reset. The Corrected Error count depends on the Signal Quality, and is automatically reset each time the receiver is restarted. For information about signal quality, see “Dish Pointing menu”.

## Errors (Uncorrected)

The UE command is available for polling the receiver to display the current Uncorrected Error count, and for clearing or resetting the current Uncorrected Error count. Observe the following syntax.

**UE=0**

**UE** polls the receiver for the current Uncorrected Error count. **UE=0** clears or resets the current Uncorrected Error count. The receiver responds by displaying the following.

**UE=###**

**###** can be any number from 0 through 65536, and is the number of uncorrected Viterbi errors counted since the last reset. The Uncorrected Error count depends on the Signal Quality, and is automatically reset each time the receiver is restarted. For information about signal quality, see “Dish Pointing menu”.

## External Security microprocessor

The OSE command is available for polling the receiver to display the network address plus the installed software version for the External Security microprocessor (Smart Card), including algorithm information. Observe the following syntax.

**OSE**

**OSE** polls the receiver for network address and installed software version information (External Security microprocessor and algorithm [Smart Card]). The receiver responds by displaying the following

**OSE=###-###-####-#, V#.##(##) -**

**###-###-####-#** is the network address, **V#.##** is the software version, **(##)** is the decryption algorithm type, and “-” is displayed only if the Smart Card is not installed.

## Frequency Stability (AFC level)

The AFC command is available for polling the receiver to display the current relative offset from the set center frequency of the decoded digital signal. Observe the following syntax.

**SA1AFC**

**AFC** polls the receiver for the current relative offset from the set center frequency (decoded digital signal), where **##** can be any number from -99 through +99. The receiver responds by displaying the following.

**AFC={+/-}##**

The receiver automatically compensates for a +/- 2.5 MHz frequency offset which is equivalent to an AFC value of approximately +/- 12.

## Installer

The INST command is available for displaying current receiver settings, or for changing the receiver settings. Observe the following syntax.

```
SA1INST=#,{##.#####/#####.##},#.##.#####, ##.####, ##.###, ##.###,
#, #####, #####
```

INST polls the receiver for the current receiver settings. To change any setting, you must use all INST command options. The receiver responds by displaying the following.

```
INST=#,{##.#####/#####.##},#.##.#####, ##.####, ##.####, ##.####, #, #####, #####
```

The accompanying table identifies each of the command parameters as displayed (from left to right), in order.

When using the INST command, a valid Downlink frequency or L-Band frequency must be specified. The INST command is valid only if Channel 0 is the current channel, and if any menu (except the Receiver Setup menu) is displayed. For more information about the current channel, see “Available Services menu”. No parameters may be omitted when using this command.

## Internal Security microprocessor

The ISE command is available for polling the receiver to display the network address plus the installed software version for the Internal Security microprocessor, including algorithm information. Observe the following syntax.

ISE

ISE polls the receiver for network address and installed software version information (Internal Security microprocessor and algorithm), where ###-###-####-# is the network address, V#.# is the software version, (#) is the decryption algorithm type, and “-” is displayed only if the ISE is not installed. The receiver responds by displaying the following

```
ISE=###-###-####-#, V#.#(#) -
```

Table 15. INST command options

Parameter	Options
1. # (Frequency Mode)	0 (Downlink), 1 (L-Band 1), or 2 (L-Band 2).
2. ##.##### (Downlink Frequency, if Frequency Mode set to Downlink) or #####.## (L-Band frequency, if Frequency Mode set to L-Band)	Range (0-15 GHz)  Range (950-2150 MHz, with 250 kHz resolution)
3. # (FEC Rate)	1 (1/2), 2 (2/3), 3 (3/4), 4 (5/6) or 5 (7/8)
4. ##### (Symbol Rate)	Range (3-30.8 MS/s [variable-rate decoders only]) ignored in fixed-rate decoders
5. #### (Local Oscillator #1 frequency [C-Band])	Range (0-15 GHz)
6. #### (Local Oscillator #2 frequency [Low Ku-Band])	Range (0-15 GHz)
7. #### (Crossover frequency)	Range (10.7-15.0 GHz) for Dual-Ku [Downlink Mode] only
8. # (Polarization)	0 (Auto), 1 (Horizontal, Fixed), 2 (Vertical) or 3 (Vertical, Fixed)
9. ##### (Network ID)	0 to 65535
10. ##### (Bouquet ID)	0 to 65535

###-###-####-# is the network address, V#.# is the software version and (#) is the decryption algorithm type, and “-” is displayed only if the ISE is not installed.

## Keypad microprocessor

The KBD command is available for polling the receiver to display the installed software version for the Keypad microprocessor. Observe the following syntax.

KBD

KBD polls the receiver for installed software version information (Keypad microprocessor). The receiver responds by displaying the following.

```
KBD=V#.#
```

V#.# is the installed software version.



## Lock Level

The LOCK command is available for polling the receiver to display the current Lock Level setting, and for changing the Lock Level setting. Observe the following syntax.

`SA1LOCK=#`

**LOCK** polls the receiver for the current Lock Level setting. **LOCK=#** changes the receiver Lock Level. The receiver responds by displaying the following.

`LOCK=#`

# can be 0, 1, 2, 3 or 4. When set to 0, receiver lockout is disabled (all options are available). When set to 1, menus and current receiver settings are displayed, and all options are available except Factory Reset and Set Password. When set to 2, menus and current receiver settings are displayed, and all receiver functions are locked out or disabled except for all Receiver Setup and User Setup<sup>1</sup> menu options. When set to 3, menus are not displayed and all user interface receiver functions are locked out or disabled. Access to menus is Password-protected when Lock Level 3 is set. When set to 4, no menus are displayed and all receiver functions are locked out or disabled (i.e., accessible via remote terminal or PCC uplink signal only).

The Lock Level setting has no affect on remote control command operation in any way.

## Main microprocessor

The ICP command is available for polling the receiver to display the installed software version for the Main microprocessor. Observe the following syntax.

`SA1ICP`

**ICP** polls the receiver for installed software version information (Main microprocessor). The receiver responds by displaying the following.

`ICP=V#.#`

`V#.#` is the installed software version.

---

<sup>1</sup> Baud Rate and TV Audio options are unlocked

## Port Control

The PCTL command is available for polling the receiver to display the current operating state of EXPANSION PORT control pins, and for enabling or disabling external control over EXPANSION PORT control pins. Observe the following syntax.

`SA1PCTL,#={H/L/R}`

**PCTL,#** polls the receiver for the current state of (specific) EXPANSION PORT control pins, where # can be 1, 2, 3 or 4. **PCTL,#=H** sets the specified port pin for local control over the HIGH state (open collector) , where # can be 1, 2, 3 or 4. **PCTL,#=L** sets the specified port pin for local control over the LOW state (grounded) , where # can be 1, 2, 3 or 4. **PCTL,#=R** sets the specified port pin for REMOTE (uplink) control over the HIGH and LOW states, where # can be 1, 2, 3 or 4. The receiver responds by displaying the following.

`PCTL,#={H/L/R}`

# can be any pin (number) from 1 through 4. For more information about the EXPANSION PORT, see "Connecting your system".

## Power

The PW command is available for polling the receiver for the current operating (power) state, or for powering the receiver on and off. Observe the following syntax.

`SA1PW={ON/OFF}`

**PW** polls the receiver for the current operating state. **PW=ON** powers the receiver on, and **PW=OFF** powers the receiver off. The receiver responds by displaying the following.

`PW={ON/OFF}`

The receiver is in standby mode when powered OFF.

## Reset

The RESET command is available for resetting (restarting) the receiver (i.e., main microprocessor) hardware. Observe the following syntax.

SA1RESET=YES

RESET=YES resets the receiver (i.e., warm boot only). The receiver responds by displaying the following.

RESET=RECV

Note that the RESET command *does not* reset the receiver operating software, or restore factory default receiver settings.

## Signal Quality

The QLTY command is available for polling the receiver to display the current relative Signal Quality of the decoded digital signal. Observe the following syntax.

SA1QLTY

QLTY polls the receiver for the current relative Signal Quality (decoded digital signal). The receiver responds by displaying the following.

QLTY=#

# can be any number from 0 (bad) through 9 (good). Signal Quality depends, in part, on the current Symbol Rate. For information about Signal Quality, see “Dish Pointing menu”.

## Signal State

The STATE command is available for polling the receiver for the current receiver operating/Signal State. Observe the following syntax.

SA1STATE

STATE polls the receiver for the current operating/ Signal State. The receiver responds by displaying the following.

STATE=#

# can be (see Table 16). Returned status codes represent all possible operating states. Note that each command response (instance) reflects the instantaneous operating state of the receiver which may indicate a response which is erroneous or unexpected. If an unexpected response is received, the steady or normalized operating state of the receiver can best be determined if this command is execute repeatedly.

Table 16. Possible signal status codes and descriptions

State Code	Response
0	No lock
10	Search Mode Active
20	Loss of Signal Time-out
30	Channel Change in Progress
40	Digital Lock, No Signal
50	Digital Lock, and Signal
60	Unauthorized Program Active
70	Authorized Program Active

## Signal Strength (AGC level)

The AGC command is available for polling the receiver to display the current relative Signal Strength (or AGC level) of the decoded digital signal. Observe the following syntax.

SA1AGC

AGC polls the receiver for the current relative Signal Strength (decoded digital signal). The receiver responds by displaying the following.

AGC=#

# can be any number from 0 (bad) through 99 (good). Signal Strength is the associated with the AGC (Automatic Gain Control) signal level. For more information about the Signal Strength, see “Dish Pointing menu”.

## **Version**

The Version command is available for polling the receiver to display the version (model) identification number. Observe the following syntax.

**SA1VER**

**VER** polls the receiver for the version (model) number. The receiver responds by displaying the following.

VER=D9234\_BSR

VER can only be the version (model) number of the receiver.



# Appendix D Customer information

This Appendix provides important information about your PowerVu Headend Satellite Receiver. Refer to this section for:

- Product support and contact information
- Product warranty/return details

## Product support

Scientific-Atlanta provides customers with 24-hour hotline support from anywhere in North America. If you require technical assistance or product training support, or if you have any questions concerning your Scientific-Atlanta product, contact the appropriate Customer Support Center from those listed below. Satellite Television Networks (STN) customers who call a Customer Support Center are asked specific questions in order to identify their needs. In this way, each call can be directed to the customer support representative most experienced with your Scientific-Atlanta product. Customer Support Centers also provide the following pre- and post-sales support services for Scientific-Atlanta products.

If you call from ...	Support Location	Regular Hours	After Hours	Fax
USA or Canada	USA: Atlanta, Georgia Canada: Toronto, Ontario	<u>Toll-free</u> : 1-888-949-4786	Toll-free: 1-888-949-4786	1-770-903-5567
South America	Buenos Aires, Argentina	+54-1-342-0321	1-770-903-4786	+54-1-325-5900
Europe, Middle East or Africa	London, England	<u>Toll-free</u> (within Europe): 1-800-220-145  <u>Direct</u> : Return Material/ tracking: +44-1923-271460 Decoder support: +44-1923-271467 Uplink/software support: +44-1923-271420	1-770-903-4786	+44-1923-269018
Asia or Australia	Sydney, Australia	<u>Toll-free</u> : 1-800-500-518  <u>Direct</u> : +61-2-9975-3678	1-770-903-4786	+61-2-9451-4432

## Hotline technical support

24-hour hotline technical support services are available to answer technical questions about the operation, maintenance and repair of Scientific-Atlanta products.

## Training support

On and off-site training plus technical support services are available for both equipment operators and system administrators.

## Warranty and post-warranty support

Warranty and post-warranty support services are available to assist customers returning Scientific-Atlanta products for service or repair.

## Customer responsibility

When returning equipment, the customer is solely responsible for equipment packaging and transportation costs both to and from the factory.

At the customer's request, Scientific-Atlanta will make reasonable efforts to provide warranty service at the customer's premises, provided that the customer pays current field service rates plus direct travel and accommodation expenses.

## In case of a fault

If an equipment fault develops, perform following steps. For complete information, see "Product return".

1.
  - Notify Scientific-Atlanta of the problem immediately, providing the model number and serial number of the equipment plus details of the problem. On receipt of this information, service information and shipping instructions will be provided.
2.
  - On receipt of instructions, return the product by prepaid freight.
  - If the product or fault is not covered under warranty, Scientific-Atlanta will provide an estimate of repair charges in advance of any work performed.

## Product return

To return any Scientific-Atlanta product for repair or replacement, follow the steps below. To be eligible for credit, a Material Return Authorization (RMA) number must accompany each product returned to Scientific-Atlanta. This number can only be obtained from your local Scientific-Atlanta Customer Support Center in advance of product return. Be sure to include this number in all correspondence.

1. Telephone or fax Scientific-Atlanta and request a Material Return Authorization for product return.
2. Tag or label the product with the following information.
  - Your name and full return address
  - Telephone contact number
  - RMA number
  - Sales order (if available)
  - Purchase order (if available)
  - Date the product was received
  - Brief description of problems
3. Repackage the product using the original carton and packing materials, if possible. If the original packaging is not available, repackage the product using a suitable corrugated carton (or similar shipping container). Be sure to wrap the product in sufficient protective packaging to prevent damage to the equipment during shipment.
4. Print or attach the following information on the outside of the carton or shipping container.
  - The full shipping address
  - Your name, your business name and full return address
  - Contact telephone number
  - RMA number
5. Ship the product prepaid and insured to the Scientific-Atlanta Customer Support Center (or other repair location) as directed. If you are unsure about where to ship the product, contact your local Scientific-Atlanta Customer Support Center, Scientific-Atlanta dealer or distributor. Scientific-Atlanta does not accept freight collect charges. Be sure to prepay all return shipments.

# Limited Warranty

Scientific-Atlanta Canada, Inc., hereafter called S-A, warrants that at time of shipment, goods sold shall be free from defects in material and workmanship, and shall be of the quality characterized and described by S-A. Notice of any defect shall be given in writing to S-A or an authorized representative immediately upon discovery of such defect within one [1] year of the date of shipment of the goods to the original purchaser only. S-A obligations under this warranty are limited to repair or replacement of the product [or accessories] that upon examination by S-A or an authorized representative are found to be defective. Under no circumstances shall the obligations of S-A under this warranty exceed the cost of goods sold. Approval for any goods returned for warranty must be obtained in advance from S-A or an authorized representative. S-A is not obligated to accept any goods returned for warranty without prior authorization. Any agreement made between an authorized S-A distributor and the original purchaser that extends product warranty beyond the one [1] year period warranted by S-A must not obligate S-A in any way. To obtain authorized warranty service, the purchaser must forward the goods by prepaid freight to S-A or an authorized service facility. S-A is not obligated to accept any costs related to the return of goods including freight, customs duties or brokerage fees incurred by the customer. This warranty is voided if a product is modified, altered or repaired by anyone other than S-A or an authorized service facility.

Repair charges deemed reasonable by S-A will apply to any goods returned for warranty and found to be in proper working condition. This warranty shall not apply to any damage caused by war or insurgence, act of God, improper maintenance or change of serial number, or by operation contrary to the information contained in the instruction manual. No liability is assumed by S-A for any collateral or consequential damages or losses associated with this product. S-A reserves the right the revise product specifications without prior notice.

## Warranty terms and conditions

All products manufactured by Scientific-Atlanta Canada Inc., hereinafter called S-A, are warranted to be free from defects in material and workmanship, and conform to currently published specifications. Scientific-Atlanta Canada extends warranty coverage to the original purchaser only. Products must be purchased from a recognized Scientific-Atlanta dealer or distributor.

## Limits of liability

Scientific-Atlanta's liability is limited to servicing, adjusting or correcting any product returned to the factory under warranty, including the replacement of defective components. Equipment repairs are billed at normal rates for any fault caused by improper installation, maintenance or use, or if the product is subject to abnormal operating conditions.

## Disclaimer

Scientific-Atlanta makes no representations that its PowerVu product line is fully compatible with similarly represented equipment from other vendors due to the wide range of implementation possibilities of the applicable standards.



Scientific-Atlanta disclaims all statutory and implied warranties such as warranties of merchantability and fitness for purpose. In no event shall Scientific-Atlanta be liable for incidental, indirect or consequential damages, regardless of being informed about the possibility of such damages, and in no event shall Scientific-Atlanta's liability exceed the purchase price of the product.

## **FCC notices**

This equipment has been tested and found to comply with the limits for a TV Interface device and Class B digital device according to Part 15 of FCC Rules. These limits are designed to provide reasonable protection against harmful interference when operated in a residential installation. This equipment generates, uses and can radiate radio frequency energy, and if not installed and used in accordance with the instructions supplied in this manual may cause harmful interference to radio communications. However, there is no guarantee that interference will not occur in a particular installation. If this equipment does cause harmful interference to radio or television reception (which can be determined by turning the equipment off and on), the user is encouraged to try to correct the interference by one or more of the following measures.

- Reorient or relocate the television receiving antenna
- Increase the separation between the equipment and the receiver
- Connect the equipment to an AC outlet on a circuit different from that to which the receiver is connected
- Contact your dealer/reseller or an experienced radio/TV technician for help

The user may find the booklet "Interference handbook" prepared by the Federal Communications Commission helpful. This booklet is available from the U.S. Government Printing Office, Washington, DC 20402, stock no. 004-000-00450-7.

Shielded cables should be used to interconnect this device with any other/peripheral equipment (e.g., TV monitors, terminals, data sources, etc.) to ensure compliance with Class B limits. Failure to do so may result in radio or TV interference. Cables should be of braided shield construction with metal end shells.

The manufacturer is not responsible for any radio or TV interference resulting from unauthorized modification of this equipment. It is the responsibility of the user to correct such interference at the user's expense.

## **Industry Canada notice**

This digital apparatus does not exceed the limits for Class B radio noise emissions from digital apparatus as set out in the radio interference regulations of Industry Canada.

Le présent appareil numérique n'émet pas de bruits radioélectriques dépassant les limites applicables aux appareils numériques de Class B prescrites dans le règlement sur le brouillage radioélectrique édicté par Industrie Canada.

**Manufacturer's Declaration of Conformity**

**The Product** PowerVu Headend Satellite Receiver  
(Type, Description)

**Reference Number** Model D9225  
(Model or Catalog designation)

**Rating** 100 - 240 VAC, 1.4 A, 50 - 60 Hz

**has been designed and manufactured in accordance with the following Harmonized standards**

- EN 60065: 1993 - Safety requirements for mains operated electronic and related apparatus for household and similar general use
- EN 55022: 1995 - Limits and methods of measurement of radio interference characteristics of information technology equipment, Class B
- EN 50082-1:1992 - Electromagnetic compatibility - Generic immunity standard, Part 1: Residential, commercial and light industry
- EN 61000-3-2:1995- Harmonic current emissions (in.current < 16A/phase)
- EN 61000-3-3:1995- Voltage fluctuations and flicker (rated current < 16A/phase)

(Number and Date of issue)

**according to the provisions of the Low Voltage Directive 73/23/EEC and the Electromagnetic Compatibility Directive 89/336/EEC, amended per Directive 93/68/EEC**

Toronto, Canada, July 1997  
(Issue place and date)

Scientific-Atlanta Canada Inc. (Satellite Television Network Div)  
(Company name)

120 Middlefield Road, Scarborough, Ontario, Canada M1S 4M6  
(Company address)

 Gina Zivkovic, Qualifications Engineer  
(Signature, Name and Title)

# Appendix E Product identification

This Appendix provides important information about your PowerVu Headend Satellite Receiver. Refer to this section for:

- Product identification information

The label affixed to the receiver rear panel contains a 16-digit product identification code number that identifies your receiver, including factory options. The accompanying figure shows the product identification code with available factory options. Use this information to help identify your receiver. For more information about product ordering, contact your local Scientific-Atlanta Customer Support Center, Scientific-Atlanta dealer or distributor.

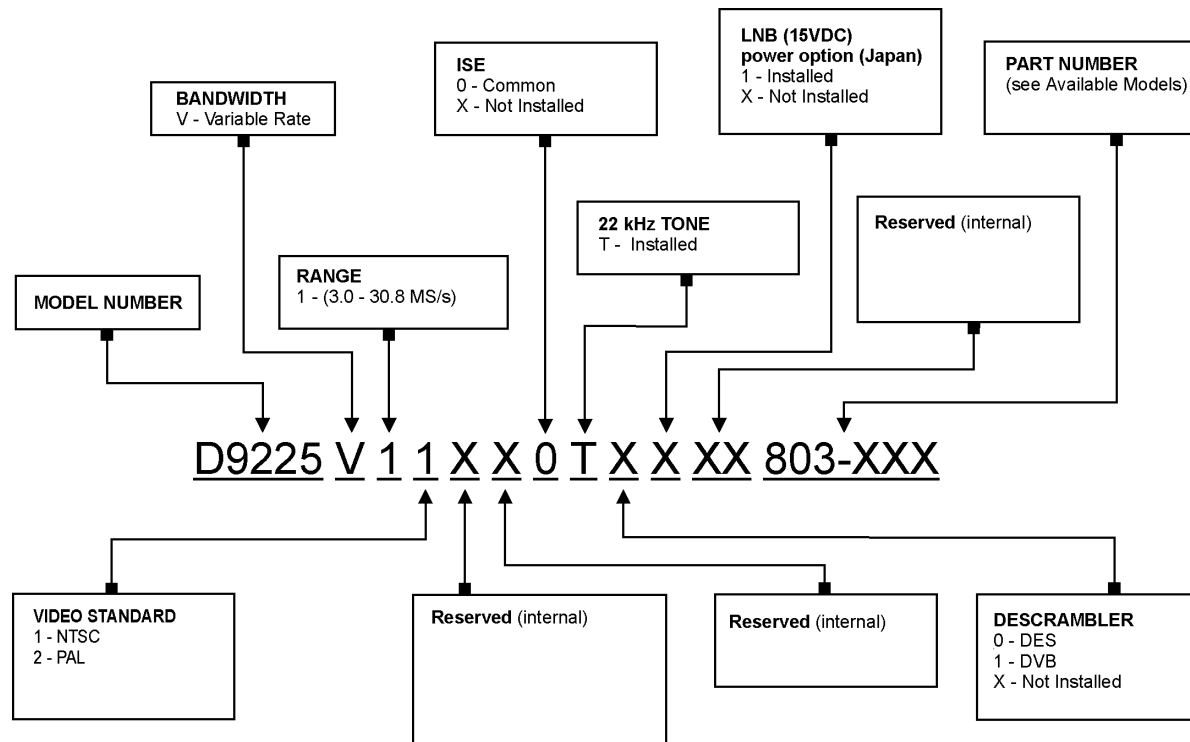

### Available Models<sup>1</sup>

<b>803-297</b>	North America (NTSC) with DVB-SS
<b>803-299</b>	Japan (NTSC) with DVB-SS
<b>803-298</b>	Euro-Asia (PAL) with DVB-SS

<sup>1</sup> Some product options are only available with certain models

### AC Cable Kits

<b>773-001</b>	Italy (3P)
<b>773-002</b>	UK (3P)
<b>773-003</b>	Australia (3P)
<b>773-004</b>	Europe (3P)
<b>773-500</b>	North America/Japan (3P)

Figure 21. Example product identification code showing options







United States: 4317-B Park Drive, Norcross, GA 30093; Tel: 1-888-949-4786; Fax: 1-770-903-5567  
Canada: 120 Middlefield Road, Scarborough, Ontario, M1S 4M6, Canada; Tel.:1-416-299-6888; Fax: 1-416-299-7145  
United Kingdom: Home Park Estate, Kings Langley, Herts WD4 8LZ, United Kingdom; Tel: +44-1923-266133; Fax: +44-1923-269018  
Australia: Unit 2, 2 Aquatic Drive, French's Forest, PO Box 292, NSW 2086, Australia; Tel: +61-2-9-452-3388; Fax: +61-2-9-451-432  
Germany: Westerbachstrasse 28-32, 61476 Kronberg, Germany; Tel: +49 (0)6173-9280; Fax: +49 (0)6173-9281-50  
Italy: Via Fosso Centroni 4, Angolo Via Anagnina, 00040 Roma, Italy; Tel: 39-67-984-0030; Fax: 39-67-984-0034  
Argentina: Argentina, S.A., 1149 Piso 11, Capital Federal 1011, Argentina; Tel: 54-11-4325-2800; Fax: 54-11-4325-5900  
Singapore: Scientific-Atlanta Pte. Ltd., 1 Claymore Drive, #08-11 Orchard Towers, Singapore 229594; Tel: 65-733-4314; Fax: 65-733-2706  
Beijing: Lucky Tower, Block B, Suite 1110-1112, 1116-1117, No. 3 Dong San Huan Bei Lu, Beijing, China 100027; Tel: 8610-6461-5761;  
Fax: 8610-6461-5754

© 1999 Scientific-Atlanta, Inc.  
Part Number 707-359 Rev. 3A

All rights reserved.

Printed in Korea.  
April 1999