

XQB100-96

Automatic Washing Machine



- Please read this manual carefully before using.
- Please retain it for future reference.
- Please check if the power receptacle is earthed reliably before usage to guarantee your safety
- The manufacture is not responsible for any risks occurred owing to disobey these stipulations.

Contents

Before using

- Names of the parts.....the 2nd cover
- Safety precautions1
- Installation and adjustment3
- Install the water inlet hose.....4

Using process

- Preparation before washing6
- Put in the laundries7
- Put in the detergent8
- Close the top lid8
- Select water level.....9
- Press the POWER button.....9
- Select program.....9
- Press the START/PAUSE button.....10
- The washing is finished10
- Disposal after washing11

Troubleshooting Answer to question.....12

- Packing list13

Specification.....the back cover

Names of the parts

Before Using

Honourable users:

Thank you for choosing our products.

Our products integrate high-tech, precision frontier science. To facilitate using it, please read this manual carefully and operate this machine according to it.

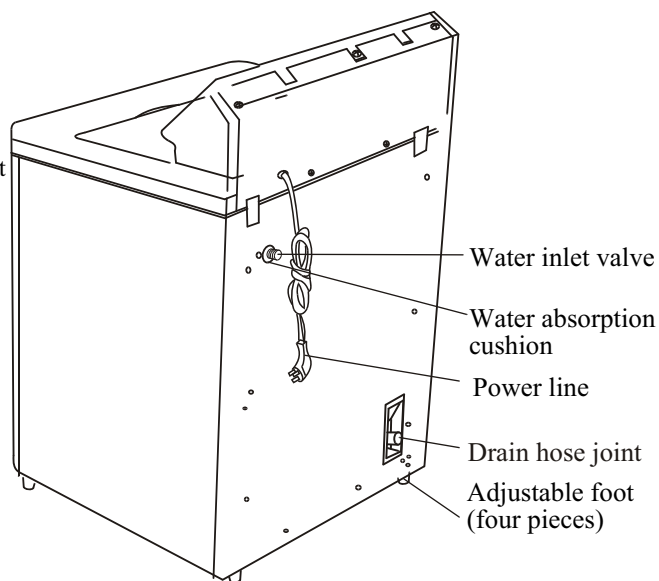
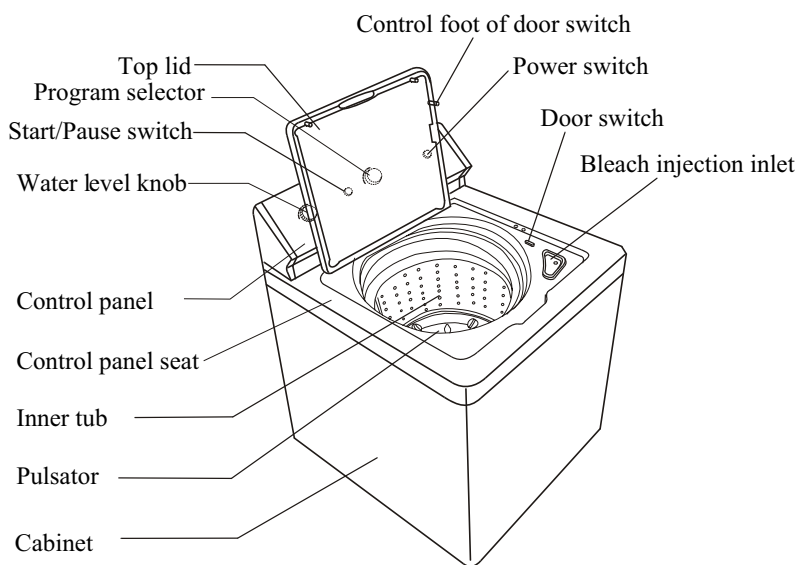

Accessories

	<p>water inlet hose (one) Water inlet hose jointer (one)</p>
	<p>Outer drain hose component (one)</p>
	<p>Drain hose clamp (one)</p>
	<p>Lint filter (one)</p>

Meaning and description of the symbols

<p>Warning sign</p>	<p>Contents marked with that symbol are related to the safety of the product and the personal safety of the users. Please operate in strict conformity to the contents, otherwise it may cause damage of the machine or injure the personal safety of the user.</p>
<p>Prohibition sign</p>	<p>Contents marked with that symbol are actions forbidden to perform. Performing of those actions may result in damage of the machine or injure the personal safety of the user.</p>

Safety precautions

Before Using

Ensure that the earth terminal of the power receptacle is earthed reliably.

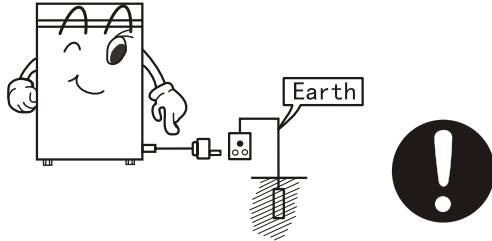

Be sure to pull the plug off when the machine is idle or when cleaning the machine. Plug prongs shall be kept clean.



If the power line is bad, to avoid risk it is required to have it replaced by the technicians of our special shop or our agent or the after-sale service department. Keep the pin of the power plug clean.



Do not put the machine at damp place like the bathroom. Never wash it with water. Do not place wet laundries on the control panel.

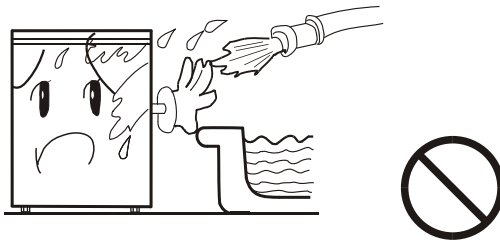

Do not use water hotter than 50°C.



Do not let the machine share one receptacle with other electric appliances. If the power plug is damaged, or the plugging into the receptacle is loose, do not use the plug any more.

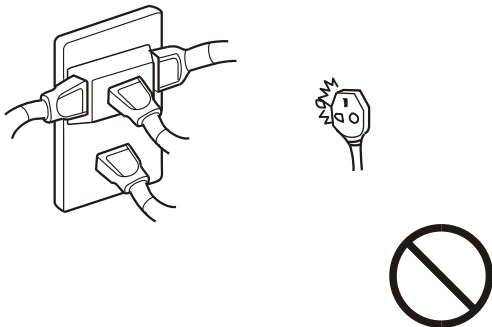

Do not wash water-proof laundries like the raincoat, bike covers etc. to avoid abnormal vibrations in spinning.

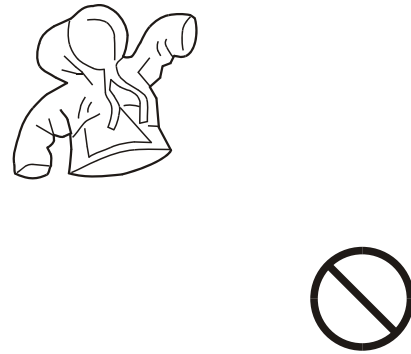

Safety precautions

Do not stretch hands into the working machine. It is dangerous even if the rotation is slow. Take special care of the children.



Do not decompose, repair or alter the machine by yourself.

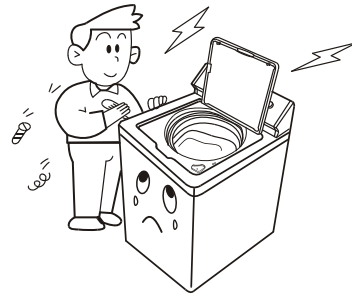

Do not put any hot or heavy items (such as the kettle with hot water) on the washing machine.



Do not wash laundries with volatile materials (such as thinner, petrol etc.)



The handicapped or children without care shall not use the machine.

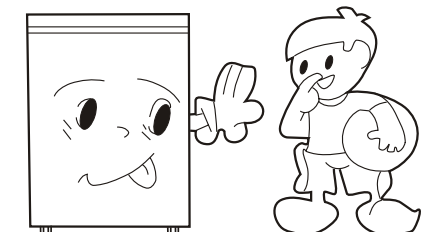

Keep the machine away from direct sunlight and heat source like the heater.

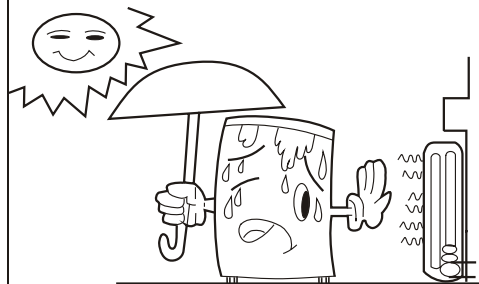

- To prevent your laundries and washing machine from damages, be sure to take out all of the foreign materials from your pocket, such as coins, buttons, sand or hair pins etc.



- In case the washing machine is installed on ground with carpet, do not block the ventilation hole with carpet.
- Before washing, please check if the water tap is open, and if the water inlet pipe is connected properly.
- It is suggested to use low-foaming washing powder.

Installation and adjustment

Before Using

Please install and adjust the machine according to the requirement of the manual. It is very important to your security and correct operating the machine.

Adjust the installation position

The largest allowed slope of the base of the machine is 2° . The slanting or rough ground will result in unstable running or stoppage of the machine. Please adjust it with following methods:

- **Confirm it's horizontal:**

Hang the lead line to confirm if it is horizontal.

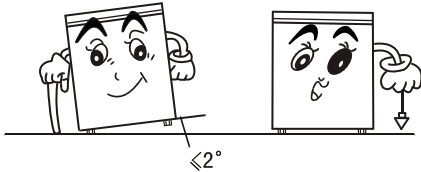

- **Adjust the adjustable foot:**

1. To twist the adjustable foot, please first lift up the side of the foot slightly, and twist the foot.
2. Fasten the nut after adjustment.



Install the drain hose

Put the drain hose clamp on the outer drain hose, insert the outer drain hose into the joint for it, and then clutch tightly with drain hose clamp.

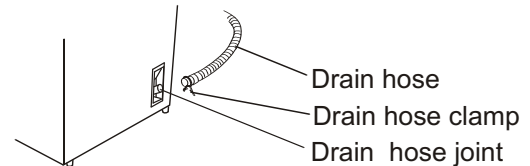

Usage of the drain hose

The drain hose shall drain smoothly

1. The height of the drain hose shall be less than 10cm, or the drainage will not be smooth, and cost such long time that the machine may stop at mid way.

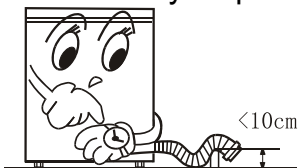

2. Do not tramp or press the drain hose.

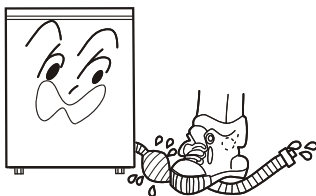

3. If the drain hose is too long, cut it at mid point. To make smooth drainage, cut the front end of the hose slantingly.

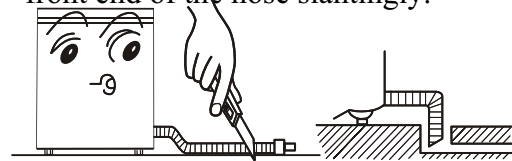

4. If extra drain hose is needed, please make separate purchase. The inner diameter of the extra hose shall not less than 30mm, and the length shall not exceed 1.5m.

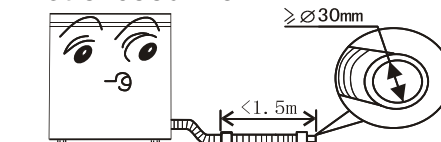

Install the lint filter

After opening the package, please take out the lint filter from the document bag and install it into the frame of the inner tub. See to the right Figure.

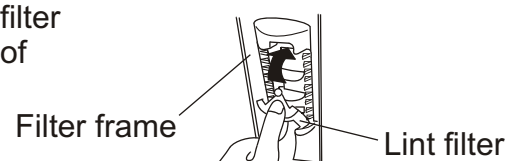

Install the water inlet hose

Confirm the water faucet

Before Using

Water faucet, suitable

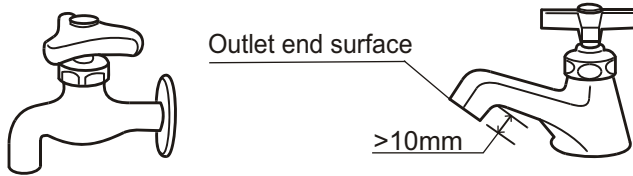

Water faucet, not suitable

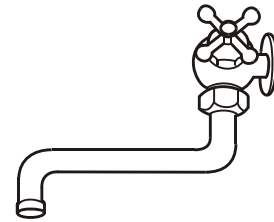

It is required that the front end shall be longer than 10cm. The outlet end surface of the faucet shall be flat and smooth. If not please file it to avoid leakage.

Connection between the water inlet hose jointer and the water faucet

1. Press the lower end of the lock lever and push down the slider. Take off the water inlet hose jointer from the water inlet hose component. See to Figure 1.
2. Loosen the screw till the water faucet can be accessed. Put the jointer of the water inlet hose on the faucet. See to Figure 2. (If the faucet is too large and the jointer can not be set on the water faucet, please loosen the four screws and take out the bushing in the jointer. See to the figure.)

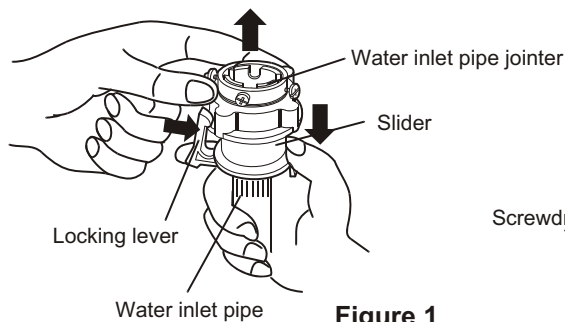

Figure 1

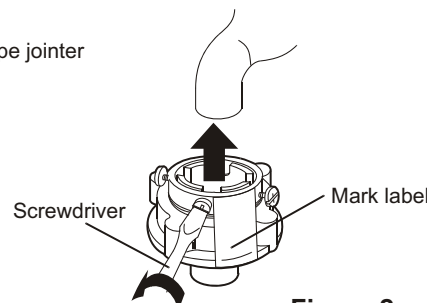

Figure 2

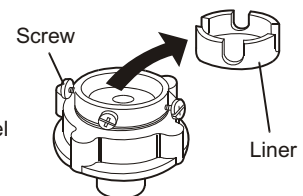

Figure 3

3. Fasten the four screws evenly. See to Figure 4.

4. Take off the nameplate. Twist the fastening nut as per the indication of the figure to seal up the outlet end surface of the faucet. See to Figure 5.

Remarks: Before installation, the threading is 4mm above the upper surface of the nut. After installation, the threading is 2mm above the upper surface of the nut. See to Figure 6.

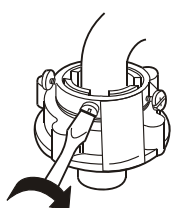

Figure 4

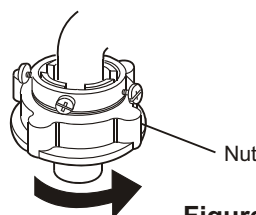

Figure 5

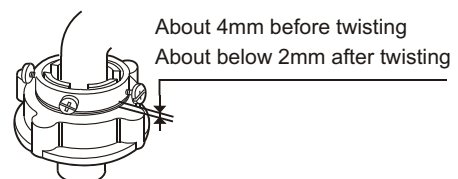
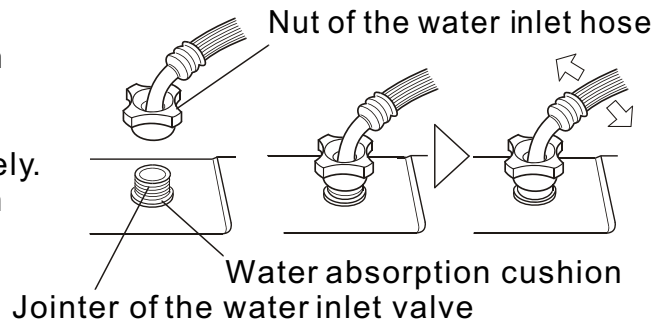

Figure 6

Connection between the water inlet hose and the washing machine

1. Do not take off the water absorption cushion. Please check if the cushion is dropped or damaged before each usage. If it happens please contact our after-sale department immediately.
2. Put the nut of the water inlet hose on the valve jointer.
3. Fasten the nut. Swing it gently to confirm if it's suitable.



Connection between the jointer of the water inlet hose and the water inlet hose

1. Push down the slider. Insert the water inlet hose into the jointer.
2. Hang the lock lever to the jointer. Release the slider till a click sound is heard.

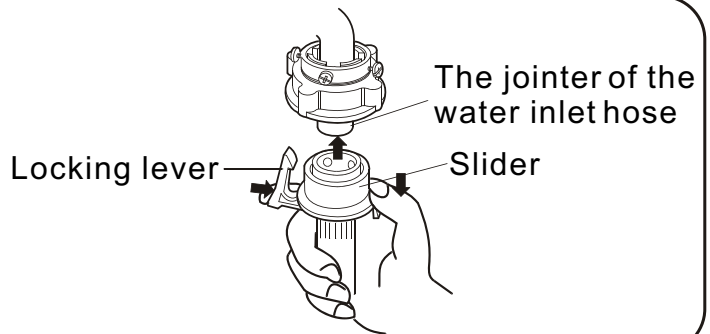

Check the connection between the jointer of the water inlet hose and the water faucet

1. Swing the hose gently to confirm if it is fastened stable.
2. After installation, open the faucet to check if it leaks.
3. Do not bend the hose with overstrain.
4. Before each usage please check if the connection between the jointer of the water inlet hose and the water faucet, and the installation of the water inlet hose are firm, so as to prevent dropping from improper installation position.

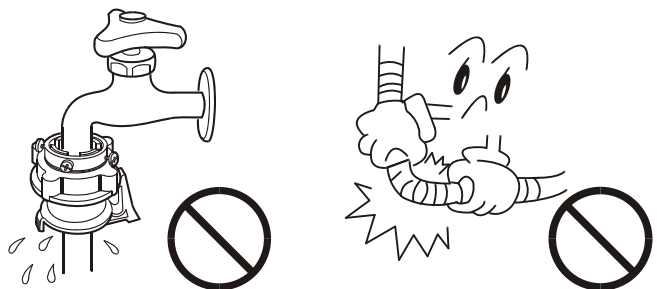

Dismantle the water inlet hose

1. Close the water faucet.
2. Press the locking lever. Push down the slider. Then pull off the water inlet hose. If the machine is used more than once every week, the jointer of the water inlet hose can be kept on the faucet to prevent damaging the fixing screw.

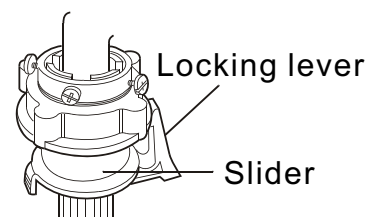

1 Preparation before washing *Using process*





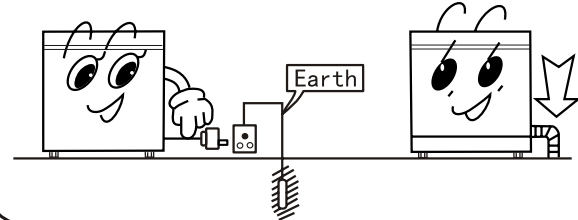

Preparation before washing

1. Connect the water inlet hose.
2. Confirm that the washing machine is earthed reliably. Then insert the power plug into the receptacle. Do not connect the earth terminal to the gas pipe and tap water pipe.
3. Put down the drain hose.

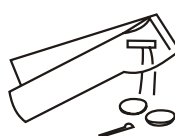

Pay attention to followings before washing the laundries

<p>Confirm if there is special requirement for the laundries.</p>	<p>Clear the pocket. Take out the coins, sand, hairpins etc.</p> 	<p>Fasten the buttons and zippers.</p> 	<p>The quantity of the laundries shall not exceed the rated value. The big laundries like the jeans shall be put in loosely.</p> 	<p>When the pulsator is running, the buttons of the laundries may cause noise. For the sake of discretion, please put the laundries with buttons into other laundries.</p> 
<ol style="list-style-type: none"> a. Please check if the laundries are applicable for washing. b. Separate those not colorfast from other laundries. c. For laundries not water absorbing, please put them into water with hands. d. For laundries with much soil, please remove the soil first. You can add detergent on the part with serious soil directly. It is much easier to remove the soil by that mean. e. For laundries likely to get lint ball or with long fibre, please first turn the inside out before putting them into water. f. Don't put the laundries polluted with chemicals directly into the washing machine. g. For those small laundries, laundries likely to be twisted or be twisted or worn, and woolen Laundries, please put them into mesh bag before washing. 				

2 Put in the laundries

Using process



- The capacity of washing and spinning of the machine refer to the largest weight of the standard laundries under dry condition that can be washed or spined in one times. Washing quantity shall be lower than the rated capacity.
The largest capacity of this machine is 10.0kg.
- The thickness, size, type of the cloth will influence the actual washing capacity. It is suitable for one time washing to put in reasonable amount of laundries and the laundries can be turned round in washing.
- Do not select high water level for laundries small than 4.0kg, so as to avoid splashing of water.

Reference weight of the laundries:

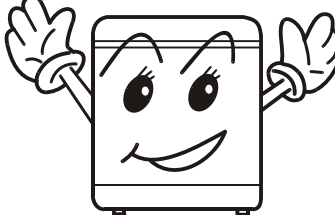

- working suit (up, down)
(cotton, about 1120g)
- Jeans (about 800g)
- Blending coat about 800g
- Jacket (cotton, about 800g)
- Single bed sheet (cotton, about 600g)
- Socking (blending, about 50g)
- Underpants (cotton, about 70g)
- Undershirt (cotton, about 180g)
- Shirt (cotton, about 300g)
- Pajamas (about 200g)
- Blanket (cotton, about 900g)

3 Add the detergent

Using process

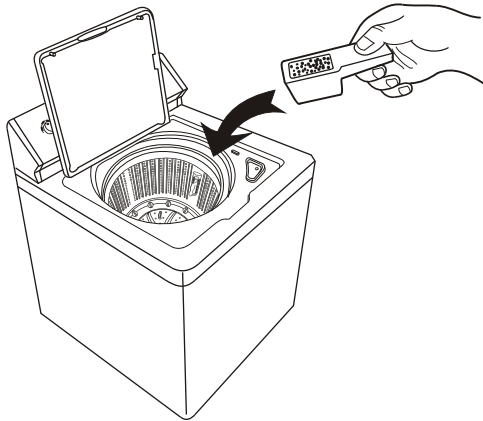

How to use the whitener

- Fill water to decided level .Dilute the whitener with container. Pour it slowly into the washing tub.
- Avoid using whitener on laundries with colour or pattern as they are prone to lose colour.
- The whitener shall not touch the laundries directly.
- Refer to the user's manual for the usage and quantity of the whitener.
- For whitener powder, please dissolve it before use.

How to use the washing powder

- Direct dissolved in the machine(not applicable for fuzzy and reserve programs)
 - 1.Fill small quantity of water.
 - 2.Add the power. Run for 30 seconds to dissolve it completely.
 - 3.Put in the laundries. Select suitable water level.
- The instant dissolving of the washing powder:
 1. Prepare warm water of 30°C and a container.
 2. Add the powder while stirring to fully dissolve it.
- The powder is more prone to pollute the laundries than the detergent. Therefore please use it with proper quantity.
- It is suggested not to use high sudsing detergent.
- Washing power with poor quality or not used for a long period may get blocked. Please clean the detergent box in time.

Standard dosage of the detergent and water quantity(suggest)

Laundries quantity (kg)	Water level	Water quantity	Common powder, Add 40g in each 30L water	Concentrated powder, Add 25g in each 30L water
7.0 ~ 10.0	High	About 95L	About 127g	About 80g
4.0 ~ 7.0	Medium	About 72L	About 96g	About 60g
Below 4.0	Low	About 51L	About 68g	About 42g

4 Close the top lid

If you open the top lid, the machine will stop working during spinning.

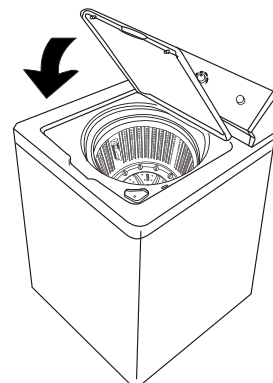

5 Select water level

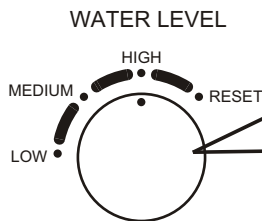

WATER LEVEL KNOB

- Three water levels available according to the laundries quantity: High; Medium; Low. Page 8
- After the water inlet as per the preset water level, in case additional water quantity is required, please first set the button to the "RESET", and perform automatic water inlet. When it reaches the suitable water level, you can turn it to the preset water level.
- After the water inlet under set water level, if higher water level is needed, please first turn the knob to "Reset", then turn back to needed water level. The washing machine will fill water to the new water level automatically.

6 Press the POWER button

Power Switch

- Using this button to switch on or off the power. When the power is on , the relevant indicator light will be lighted.
- When the washing is over , it will switch off the power automatically.

POWER



7 Select program

- Circumvolve this knob, the following programs can be selected solely: wash, strong, stanard, gentle, spin
- ### Mode and meaning of the indicator light

- The frame of indicator is not lighted.
- ◐ the frame of the indicator is flashing : indicate the running program.
- the frame of the indicator is on : indicate the program about to run, or indicate the selected mode
- ☀ the frame of the indicator is flashing rapidly: indicate abnormal condition.

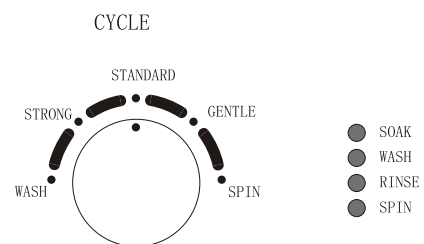

Paraphrase of the program

Program	the occasion	total time (min)
Wash	Just washing , the water can be usedrepeatedly.	About 6 (not including inleting water)
Strong	Including soking, it is the same with the very dirty clothing.	About70 (not including inleting water)
Standard	The common washing	About40 (not including inleting water)
Gentle	Washing woolen textile or underwear	About23 (not including inleting water)
Spin	Only needing spinning after washing with hands	About7 (not including draining water)

The method of the program indicator light

The indicator light Cycle	SOAK	WASH	RINSE	SPIN	THE CYCLE IN POINT
WASH	●	○	●	●	Only washing, without draining water
STRONG	○	○	○	○	Soak • Wash • Rinse • Spin
STANDARD	●	○	○	○	Wash • Rinse • Spin
GENTLE	●	○	○	○	Gentle • Rinse • Spin
SPIN	●	●	●	○	(Drain water) only spin

Attention

- Even there's no water in the tub, the spinning will start after a certain period.
- Do not use the "soak" program for the woollen laundries.
- Wash the laundries that are prone to lose colours separately from other laundries.
- To wash thin laundries such as the stocking, silks etc., please put them into washing bag (which is selectable part).

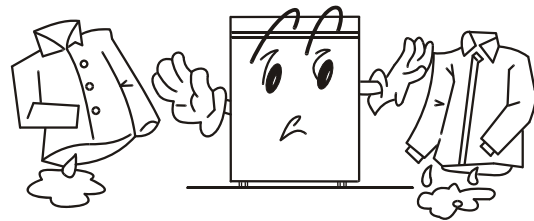

8 Push the "start/pause" button

- After the power is switched on, push it to start the machine
- During working, push it to pause working.
During pause, push it to resume working.
- When in pause, the indicator light which is flashing will be light only.
- Press the Start/Pause button, the indicator light will flash.

START/PAUSE



- Attention:
- If you have pushed the Start/Pause button, you will select only during the soaking or washing.
 - If you want to select during other cycle, you must switch off the power for more than 3s, then switch on the power to select again.
 - It will drain water for set time only when there is water in the tub; if there is no water in the tub, it will drain water for 10 seconds, then turn to the next cycle.
 - When running the rinsing cycle, it will rinse twice, but when rinsing in the gentle cycle, it will rinse only once.

9 The washing is finished



It beeps to indicate the finishing of washing

The power will be switched off automatically after the finishing of the washing.

10 Disposal after washing

- After using, please clean the lint and foreign materials of the lint filter etc. in time. Otherwise it may influence your using the machine.
- Please first pull off the power plug from the receptacle before cleaning.

The disposal of the lint filter

- The lint filter must be used during washing.
- It must be cleaned in time after each using

1、 Dismantle the lint filter:

Same as fig 1, put hand in place, then push it down to dismantle.

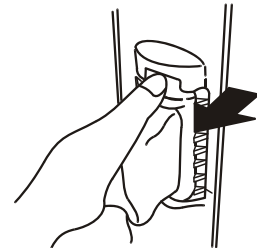

Fig 1

2、 Clean the lint:

While the lint is wet, put it into water, then clean it (same as fig 2).

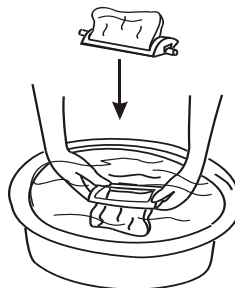

Fig 2

3、 Install the lint filter:

After cleaning the filter, insert the bottom of the filter into the filter lid, then push the top of the filter to install it(same as fig 3).

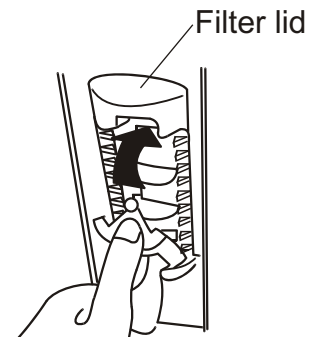
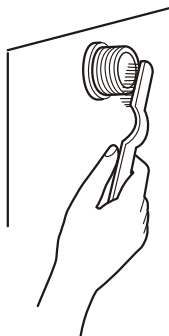

Fig 3

The filter screen of the water inlet valve is likely to be blocked by foreign materials and influence the water inlet. Please clean it with brush every two months.



If the cabinet is dirty, wipe it with wet cloth

- Do not flush it directly with water.
- Wipe it with neutral detergent.
- Do not wipe it with thinner, petrol, alcohol etc.

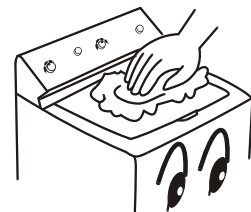

1. After washing, close the water faucet. (If needed, you can dismantle the water inlet hose).
2. Do not store water in the washing machine for a long period. Drain the water completely after each using.
3. Be sure to pull off the power plug before maintenance.
4. Hang up the power cord and drain hose.
5. Wipe off the water drops on the surface of the machine and inside the tub. Open the top lid for some time (about 1 hour), then close the top lid.

Troubleshooting Answer to question

(If there's breakdown, please pull off the power plug before checking) The following phenomena are not breakdowns sometimes. Please confirm again before sending it to repair. If there are real breakdowns, please come to the special maintenance department or after-sale service department of our company. Do not repair it by yourself.

Phenomenan		The reason	How to settle
In rinsing, spinning, the machine stops running. (The indicator light flashing)		<ul style="list-style-type: none"> ● The top lid is not closed. 	<ul style="list-style-type: none"> ● Close the top lid.
There is still water after draining for 5 minutes(the indicator light of soak, wash, rinse, spin flashing).		<ul style="list-style-type: none"> ● Is the drain hose put down? ● Is the drain hose blocked by foreign material? 	<ul style="list-style-type: none"> ● Put down the drain hose. Open and close the top lid once. ● Clean the foreign material . Open and close the top lid once.
The safety switch acts. The spinning can not work (the rinse, spin light flashing)		<ul style="list-style-type: none"> ● Are the laundries put slantingly? ● Is the machine slanting? 	<ul style="list-style-type: none"> ● Re-order the laundries. Close the top lid. ● Level the machine in right position. Open and close the top lid once.
It does not do water inlet or the speed is slow (the water level is not reached after 20 minutes. The wash rinse is flashing).		<ul style="list-style-type: none"> ● Is the water faucet open ? ● Is the water inlet valve blocked? ● Is the hydraulic pressure too low? 	<ul style="list-style-type: none"> ● Open the water faucet. Open and close the top lid once. ● Clean the water inlet valve . Open and close the top lid once. ● Please use the machine after the hydraulic pressure reached to the rating.
the machine does not act	No washing	<ul style="list-style-type: none"> ● Is there power failure? ● Is the power plug loose? ● Does the water reaches the preset level? 	<ul style="list-style-type: none"> ● Use it when the power is on. ● Insert the power plug tightly. ● Fill water to the preset level.
	No spinning	<ul style="list-style-type: none"> ● Is the power plug loose? ● Is the top lid closed? ● Are the laundries Distributed evenly? 	<ul style="list-style-type: none"> ● Insert the power plug tightly. ● Close the top lid ● Distribute the laundries evenly.
There's abnormal sound inside the machine.		<ul style="list-style-type: none"> ● Is the machine slanting? ● Are the laundries slanting in spinning? 	<ul style="list-style-type: none"> ● Level the machine properly. ● Re-order the laundries. Close the top lid.
The water faucet leaks.		<ul style="list-style-type: none"> ● Is the jointer screw of the water inlet hose loose or twisted awry? 	<ul style="list-style-type: none"> ● Fasten the jointer screw properly.

Common phenomena

Phenomena	Explanation
<ul style="list-style-type: none"> ● The spinning is intermittent when it starts. 	<ul style="list-style-type: none"> ● Balance the laundries to avoid slanting.
<ul style="list-style-type: none"> ● Select the SPIN program, but it doesn't work. 	<ul style="list-style-type: none"> ● The program is setting the drain time. Some time is needed before it starts spinning.
<ul style="list-style-type: none"> ● There may be some water flowing out of the drain hose in the first use of the machine. 	<ul style="list-style-type: none"> ● It is the water remained in the factory inspection of performance.
<ul style="list-style-type: none"> ● At the last spinning, it stops spinning, turns to rinse and inlets water. 	<ul style="list-style-type: none"> ● The reason is that the laundries leaning to one side, so the safety switch acts. After inleting water, churning up , the slant has been eliminated, then spinning again.

Packing list

Name	Quantity	Storage position
● User's manual	● One	● Inside the document bag
● Lint filter	● One	● Inside the document bag
● Drain hose clamp	● One	● Inside the accessory bag
● Components of the water inlet hose	● One	● Inside the accessory bag
● Outer drain hose	● One	● Inside the washing machine
● Computerized Automatic washing machine	● One	

Specification

Model	XQB100-96
Rated voltage•frequency	220V ~ • 50Hz
Water level/Water quantity (about)	High/95L Medium/72L Low/51L
Max water consumption	About285L(highest water level; standard program)
In lection pressure	0. 03MPa ~ 0. 78MPa
Rated washing power	440W
Rated spinning power	360W
Weight	About68. 5kg
Dimension	L686mm W686mm H1115mm
Rated washing capacity	10. 0 kg
Rated spinning capacity	10. 0 kg