



Electrolux

Factory Parts Catalog

Product No.	E36GC76GPS1
	37766426970S1
Series	36" gas
Color	stainless
Market	North America
Wiring Diagram	318047111
Owner's Guide	318200687
Installation Instructions	318201475

Electrolux

Electrolux Major Appliances
 North & Latin America
 P.O. BOX 212378
 AUGUSTA, GA 30917

Publication No.
5995512497
 08/04/25
 (EN/SERVICE/ECL)
 377

36" GAS COOK-TOP

Model No.
E36GC76G

Copyright © 2008 Electrolux Home Products, Inc.
 All rights reserved.

COOK TOP

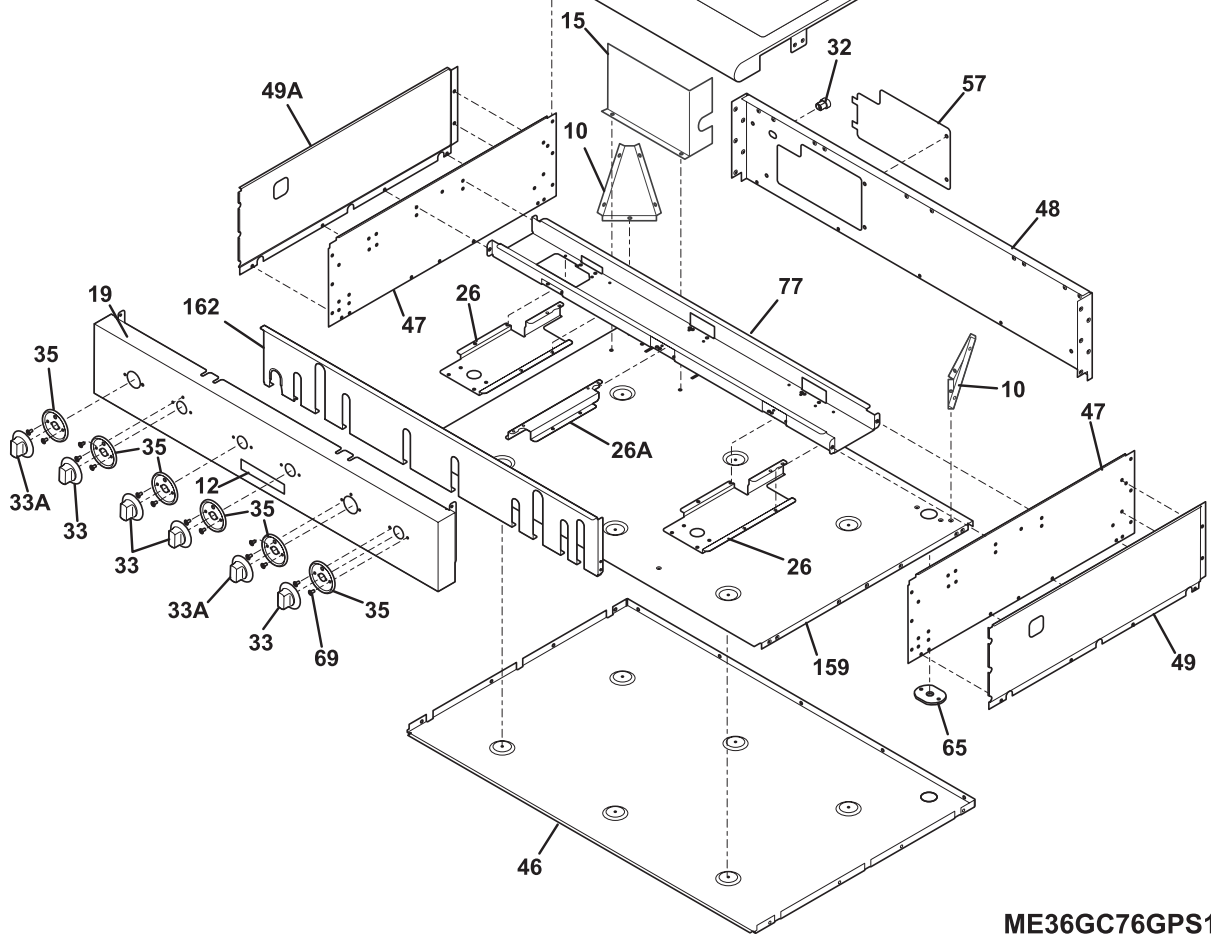
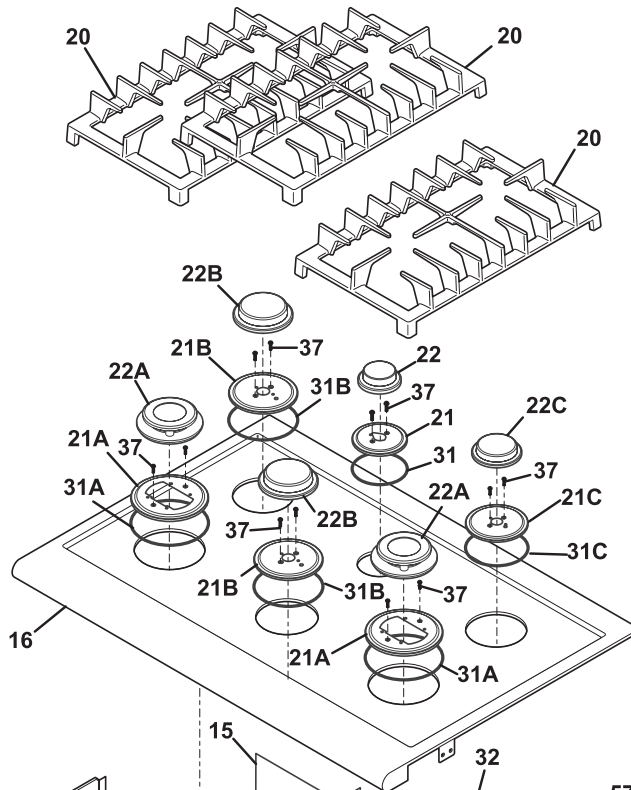
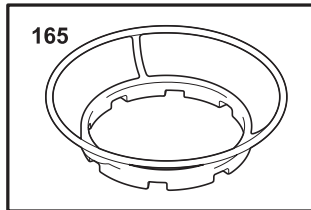
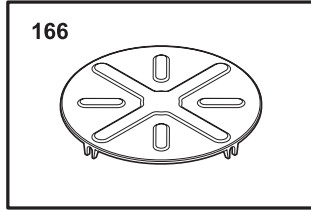
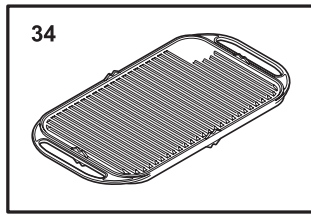

ME36GC76GPS1

COOK TOP

POS. NO	PART NO.	DESCRIPTION
10	7318392500	Bracket, box, (2)
*	75304403558	Screw, 10-16 x 0.250
12	7241603101	Label, nameplate, elux/icon
15	7318024206	Deflector, spark module
16	7318185209	Main Top Assy, frame/glass, stainless/black
19	7318285748	Panel, control, stainless
20	7318361402	Grate, top burner, black, (3), double
21	7316514800	Skirt, 5K burner, black
21A	7316515100	Skirt, 18K burner, black
21B	7316515000	Skirt, 14K burner, black, (2)
21C	7316514900	Skirt, 9.5K burner, black
22	7316510902	Cap, 5K burner, black
22A	7316511502	Cap, 18K burner, black, (2)
22B	7316511302	Cap, 14K burner, black, (2)
22C	7316511102	Cap, 9.5K burner, black
26	7318363800	Bracket, channel mtg, (2)
26A	7318363900	Bracket, channel mtg.
31	7316515200	Seal, 5K burner
31A	7316515203	Seal, 18K burner, (2)
31B	7316515202	Seal, 14K burner, (2)
31C	7316515201	Seal, 9.5K burner
32	73201437	Strain relief
33	7318242225	Knob, control, (4)
33A	7318242226	Knob, control, dual, (2)
34	7318251600	Griddle
35	7318251911	Skirt, (6)
37	7316518100	Screw, ignitor assy mt, 6-32 x .62
39	7318144006	Cord, service
46	7318242805	Panel, base
47	7318241712	Panel, side, (2)
48	7318241806	Panel, rear
49	7318241904	Panel, interior side, RH
49A	7318241905	Panel, interior side, LH
57	7318286400	Panel, service
65	75303304032	Seal, rubber
69	75303300265	Screw, 8-18 X 1/2, (4)
77	7318355511	Bracket, channel mtg.
159	7318242912	Panel, bottom
162	7318399700	Deflector, heat
165	7318254300	Support, WOK
166	7318254200	Simmer Plate
*	7316459400	Pad, cleaning
*	7318163602	Cleaner, stainless steel
*	708016432	Screw, truss head, 8-18 x 0.375
*	75303305528	Screw, 8-32 x 1/4

BURNER

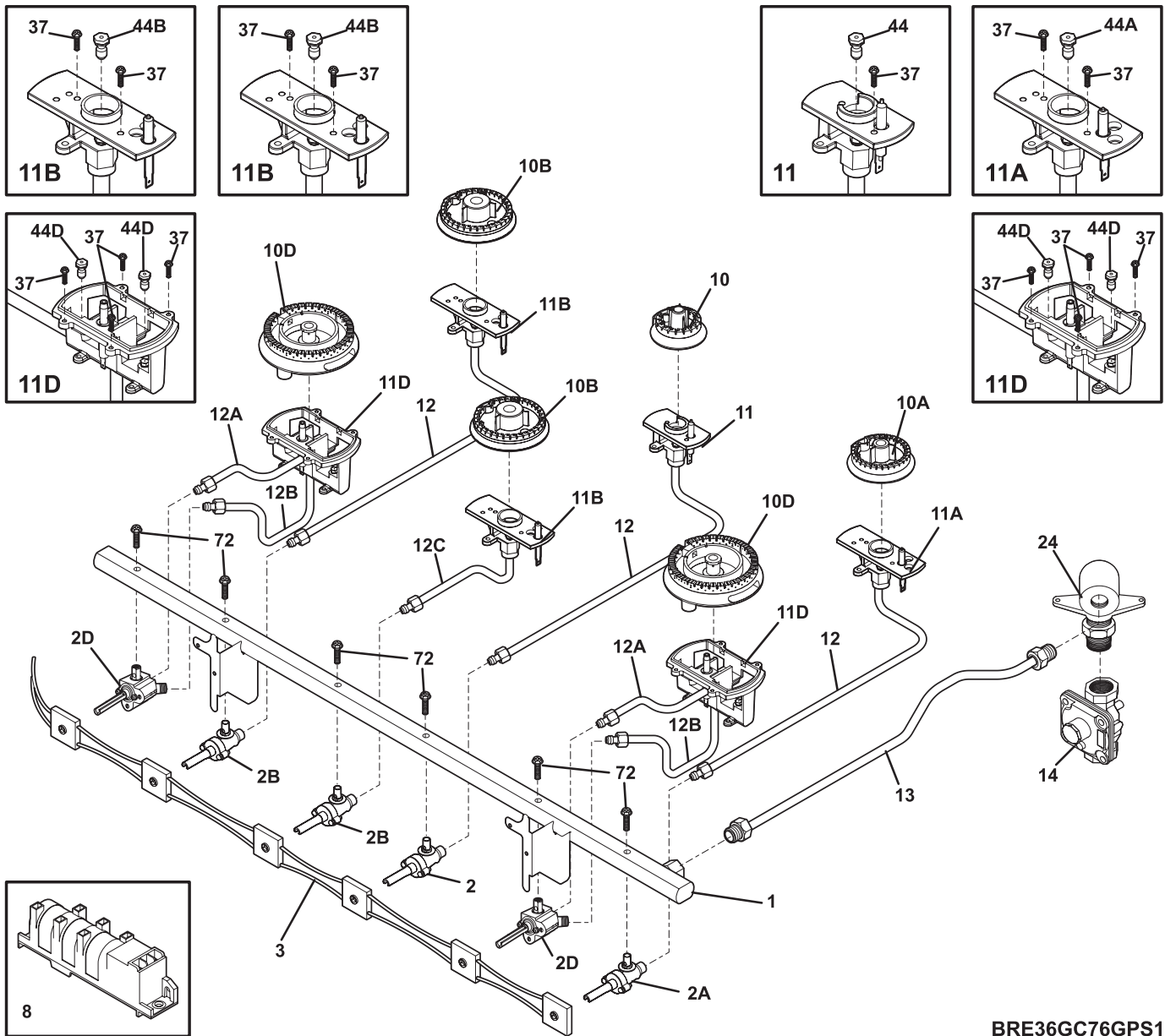

BRE36GC76GPS1

BURNER

POS. NO	PART NO.	DESCRIPTION
1 #	7318234314	Manifold Pipe
2 #	7316520700	Valve, burner, 5K
2A #	7316520701	Valve, burner, 9.5K
2B #	7316520703	Valve, burner, 14.2K
2D #	7316412510	Valve, top burner, 18K, dual port
3 #	7318232635	Wiring Harness, w/igntr switch
8	7318079001	Module, spark
*	75303311174	Screw, 10-24 x 3/8
10 #	7316510800	Burner, sealed, 5K
10A#	7316511000	Burner, sealed, 9.5K
10B#	7316511200	Burner, sealed, 14K
10D#	7316525400	Burner, sealed, dual, 18K
11 #	7316524800	Ignitor/orifice assy., top burner, 5K, w/holder
11A#	7316524900	Ignitor/orifice assy., top burner, 9.5K, (2), w/holder
11B#	7316525000	Ignitor/orifice assy., top burner, 14K, w/holder
11D#	7316525100	Ignitor/orifice assy., top burner, 18K, w/holder
12 #	7318221383	Tubing, 5/9.5/14K, rear, (3)
12A#	7318221382	Tubing, 18K, (2)
12B#	7318221381	Tubing, 18K, (2)
12C#	7318221384	Tubing, 14K, front
13	7318054513	Connector, manifold tube
14 #	7318122705	Regulator, pressure
14*	7318531900	Clip, (3)
24	7318054010	Elbow, fitting
*	708011955	Screw, 10-24 x 0.375, square drive
37	7316518100	Screw, ignitor assy mt, 6-32 x .62
44	7316523504	Orifice, top burner, 5K
44A	7316523500	Orifice, top burner, 9.5K
44B	7316523506	Orifice, top burner, 14K
44D	7316523508	Orifice, top burner, 18K
72	7316215600	Screw, valve mtg., 1/4 - 20
* #	7318243102	Harness, burner wiring
* #	7318127438	LP Conversion Kit

WIRING DIAGRAM

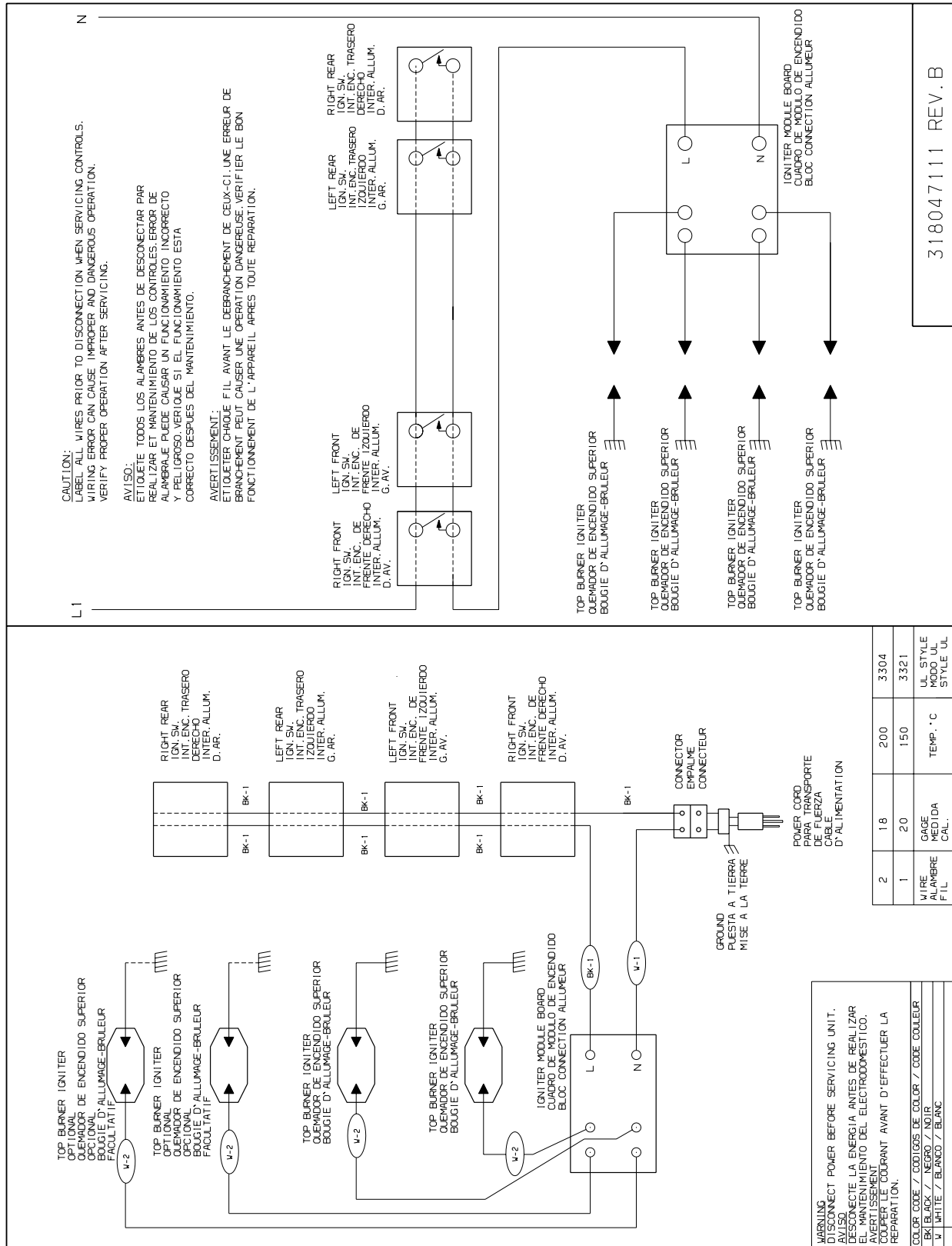

318047111 REV. B