



DCM Series

Digital Cinema Monitor & Crossover System

USER MANUAL

DCM-1

DCM-2

DCM-3

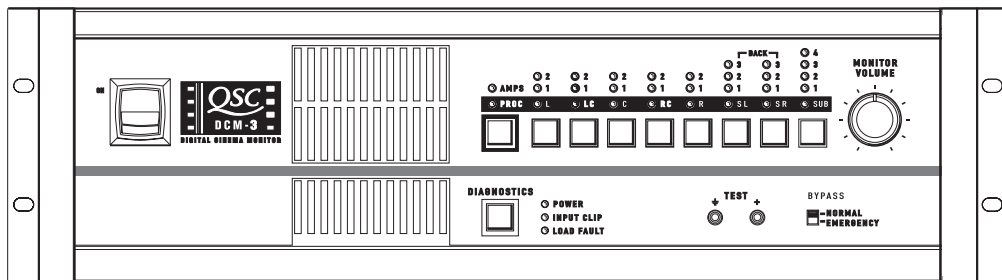
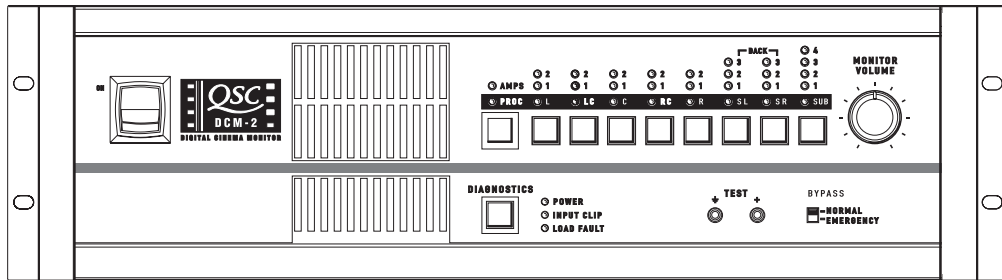
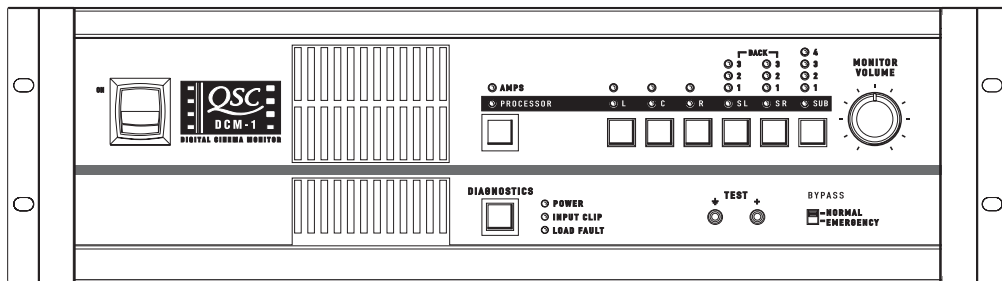

IMPORTANT SAFETY INSTRUCTIONS & EXPLANATION OF SYMBOLS

- 1- Read these instructions.
- 2- Keep these instructions.
- 3- Heed all warnings.
- 4- Follow all instructions.
- 5- Do not use this apparatus near water.
- 6- Clean only with a dry cloth.
- 7- Do not block any ventilation openings. Install in accordance with QSC Audio Product's instructions.
- 8- Do not install near any heat sources such as radiators, heat registers, stoves, or other apparatus (including amplifiers) that produce heat.
- 9- Do not defeat the safety purpose of the polarized or grounding-type plug. A polarized plug has two blades with one blade wider than the other. A grounding-type plug has two blades and a third grounding prong. The wide blade or the third prong is provided for your safety. If the provided plug does not fit your outlet, consult an electrician for the replacement of the obsolete outlet.
- 10- Protect the power cord from being walked on or pinched, particularly at plugs, convenience receptacles, and the point where they exit the apparatus.
- 11- Only use attachments/accessories from QSC Audio Products, Inc.
- 12- Use only with carts, stands, tripods, brackets, interconnecting cables, or software specified by QSC Audio Products. When moving or transporting using a cart, use caution to avoid injury from tip-over.
- 13- Unplug the apparatus during lightning storms or when unused for long periods of time.
- 14- Refer all servicing to qualified personnel. Servicing is required when the apparatus has been damaged in any way, such as power supply cord or plug is damaged, liquid has been spilled or objects have fallen into the apparatus, the apparatus has been exposed to rain or moisture, does not operate normally, or has been dropped.
- 15- When installing equipment into a rack, distribute the units evenly. Otherwise, hazardous conditions may be created by an uneven weight distribution.
- 16- Connect the unit only to a properly rated supply circuit.
- 17- Reliable earthing (grounding) of rack-mounted equipment should be maintained.
- 18- Maximum operating ambient temperature is 50°C.



The lightning flash with arrowhead symbol within an equilateral triangle is intended to alert the user to the presence of uninsulated "dangerous" voltage within the product's enclosure that may be of sufficient magnitude to constitute a risk of electric shock to humans.



The exclamation point within an equilateral triangle is intended to alert the user to the presence of important operating and maintenance (servicing) instructions in this manual.

CAUTION
RISK OF ELECTRIC SHOCK
DO NOT OPEN

CAUTION: To reduce the risk of electric shock, do not remove the cover. No user-serviceable parts inside. Refer servicing to qualified service personnel.
WARNING: To prevent fire or electric shock, do not expose this equipment to rain or moisture.

FEDERAL COMMUNICATIONS COMMISSION (FCC) INFORMATION

NOTE: This equipment has been tested and found to comply with the limits for a Class A digital device, pursuant to Part 15 of the FCC Rules. These limits are designed to provide reasonable protection against harmful interference in a commercial installation. This equipment generates, uses, and can radiate radio frequency energy and, if not installed and used in accordance with the instructions, may cause harmful interference to radio communications. Operation of this equipment in a residential area is likely to cause harmful interference, in which case the user will be required to correct the interference at his or her own expense.

© Copyright 2002, QSC Audio Products, Inc.

QSC® is a registered trademark of QSC Audio Products, Inc.

"QSC" and the QSC logo are registered with the U.S. Patent and Trademark Office

CONTENTS

Introduction.....	4
System Requirements.....	5
Unpacking.....	5
System Concepts.....	6
Illustrations.....	8
Hardware Description.....	11
Software Description.....	18
Installation.....	19
Troubleshooting.....	29
Specifications.....	32
Warranty Information.....	34

The DCM hardware unit and DCM Manager software are the property of QSC Audio Inc. Information in this document is subject to change without notice and does not represent a commitment on the part of QSC Audio. The software described here is furnished under a licensing agreement. It is against the law to copy the software on any medium except as specifically allowed in the licensing agreement. DCM Manager is a trademark of QSC Audio Products, Inc; Windows and Windows 98, NT, XP and 2000 are trademarks of Microsoft Corporation; IBM is a registered trademark of IBM Corporation; Pentium is a registered trademark of Intel Corporation. Copyright 2002 QSC Audio Inc. All rights reserved. Printed in USA. QSC Audio Products, Inc., Technical Document Number TD-000106-00.

INTRODUCTION

INTRODUCTION

Thank you and congratulations on your purchase of the QSC DCM Digital Cinema Monitor. This product represents the state-of-the-art for cinema-based signal processing and monitoring functions in a single, integrated system. Designed to compliment QSC's DCA (Digital Cinema Amplifier) Series amplifier products, the DCM optimizes loudspeaker performance while facilitating easy cinema sound system wiring and configuration. To get the most from your investment, we encourage you to review this manual carefully.

The QSC DCM provides a wealth of signal processing functions with the ability to copy and transfer settings—resulting in fast system setup time in multiplex theaters where multiple rooms share similar characteristics. Providing both monitor and crossover functions in a single unit, the DCM is capable of simple crossover adjustments via a personal computer (PC). These modifications can be password protected for tamper-proof system control.

Fast Setup with Easy Wiring

Your DCM takes advantage of the unique DataPort found on DCA Series amplifiers and thus greatly simplifies system wiring—reducing installation and labor costs in the process. A single VGA-style cable per amplifier contains two input signals, two return signals, power on/standby control, and two channels of load monitoring.

The included menu-driven, PC configuration software further enhances the DCM setup. This software includes a database that lists the default parameters for popular cinema loudspeaker models. Commonly used configurations can be saved to disk, facilitating the easy transfer of settings to other DCMs.

Advanced Monitoring Control

In addition to the monitoring of your amplifier's audio I/O, your DCM includes QSC's exclusive "Load Fault" detection feature. The DCM monitors for possible speaker system or wiring faults and notifies you via LED Load Fault indicators.

FORMAT	DCM-1	DCM-2	DCM-3
6 Ch Bi-amp	yes	yes	yes
6 Ch Tri-amp		yes	yes
8 Ch Bi-amp		yes	yes
8 Ch Tri-amp			yes
Surround-EX Ready	yes	yes	yes

SYSTEM REQUIREMENTS and UNPACKING

SYSTEM REQUIREMENTS

DCM Manager software is designed to control one DCM hardware unit at a time. To use this software with the DCM hardware unit, you must have the following:

- 1- Digital Cinema Monitor unit
- 2- DCM Manager software installation CD
- 3- IBM-compatible PC with a 200 MHz Pentium processor (or better)
 - Windows 98, NT, XP, or 2000
 - Microsoft® Internet Explorer 4.0 (or later)
 - Minimum 16MB of RAM
 - Minimum 10MB of available hard disk storage space
 - CDROM drive
 - Display resolution of 800X600, 16 colors minimum
 - RS-232 serial port (COM port, 9-pin)
 - A standard DB9 RS-232 cable (male to female)

To complete your Cinema System, you will also need a cinema processor, QSC Audio's DCA amplifiers, speakers, and necessary cables.

UNPACKING

The DCM is highly durable and carefully packaged. We recommend you inspect the unit carefully after removing it from the packaging, as occasionally there may be damage due to some unfortunate incident during shipment. Report any damage to the shipping carrier. We recommend saving the carton and packing material in case the unit must be shipped back to your dealer, distributor, or service center. Also note: some freight companies consider damage claims without the original packing materials invalid.

The QSC shipping box should contain:

- 1- the DCM unit
- 2- this owner's manual
- 3- four adhesive feet (for non-rack mounting installation)
- 4- AC power cord, IEC-type, 18 AWG, 6 feet long, 120V
- 5- warranty card
- 6- QSC store catalog
- 7- QSC accessories sheet
- 8- DCM Manager Application Disk

SYSTEM CONCEPTS

SYSTEM CONCEPTS

System Design Features

The DCM series Digital Cinema Monitor has many unique features which combine to make this the most cost effective and versatile systems solution in the industry.

Installer Features:

- Provides Monitor and Crossover functions in one box.
- Minimizes the amount of cabling required. Only 1 cable per two-channel amplifier!
- Minimizes setup time, particularly in megaplexes with similar rooms.
- Provides speaker setting database for most common theater speaker brands and models.
- Indicates if something is wrong with the sound system and provides diagnostic feedback.
- Emergency bypass allows center channel sound to pass through even if there is a major problem.
- Allow easy routing and crossover adjustments.
- Protects system adjustments from tampering.
- Sound quality is state-of-the-art (high dynamic range).

Projectionist Features:

- Easy to verify all of the audio in the theater is okay.
- Automatic monitoring will light an LED if there is trouble with a speaker output.
- A backup system (emergency bypass) can be easily activated.

1. QSC Amplifier DataPorts: The DataPort connectors reduce the complexity of wiring between the DCM and the amplifiers. The DataPort connections replace amplifier audio input cables and amplifier output monitor connections. Another unique feature of the QSC Cinema System is the ability to automatically analyze voltage and current on the amplifier's output terminals to determine shorts or opens in the speaker cables or drivers. Each two-channel amplifier is connected using one DataPort cable. We recommend you use QSC DataPort cables, but normal computer VGA cables will work providing that all pins are terminated. QSC's Technical Services Group can supply DataPort cables with high quality shielded audio wires within the cable for maximum interference protection on long runs or for electrically-noisy environments.

2. Programmable processing and crossover settings: DCM processing is adjusted using the DCM Manager software and the RS-232 connection. Configuration files can be saved and used for other DCMs. For example, if a megaplex theater has several rooms with similar size and equipment, a technician can adjust one DCM unit for best results, and then download all of these settings to other DCM units. The functions that can be controlled remotely are: crossover settings for screen channel outputs, mutes, multiple equalizer settings per channel, delay times, output volume levels, monitor mix balance adjustments, and more.

SYSTEM CONCEPTS

3. DSP processing: Digital filtering of audio signals is known to have several advantages over analog solutions. DSP (digital signal processor) IC chips allow extremely accurate and reliable control of frequency and time adjustments (boost, cut, cutoff frequency, delay time), and stability (immunity from temperature variations). The audio path of the DCM uses conversion circuitry (changing the signal from analog to digital and back again) which is designed to minimize all background noise and react to the dynamic range of any film track.

4. Speaker Database (pre-programmed settings): QSC has worked with the leading suppliers of theater speakers to obtain the optimum settings for most common theater speaker models. This database is easily loaded into the DCM hardware unit and the DCM Manager software offers features to organize, store, and edit these settings. This feature guarantees that your installation starts with technically optimized settings before you begin adjusting for room characteristics.

5. Fault Analysis: Each amplifier output channel is compared to the corresponding input signal providing complete signal path confirmation. For example, if there is signal at the DCM input but there is no signal at the corresponding amplifier output, then the fault indicator will light. Additionally, if an amplifier output is shorted or open, the fault indicator will light. Pressing the Diagnostics button will indicate which channel has this fault condition. Detailed fault information can also be viewed using the DCM Manager software.

6. Password Security: The crossover settings that you create can make a dramatic difference in the sound quality within the theater. Many installers pride themselves on being able to adjust the electrical parameters (crossover points, equalization, delay, etc) to exactly compliment the speaker and room interactions. As such, their ability to set these parameters is a “value added” service which deserves protection from competitors. We have therefore included a security system where you can protect your settings within the DCM from being uploaded and copied by the DCM Manager software. Only your unique password will allow viewing or editing of the crossover settings. Should you forget your password, an entirely new configuration can be loaded.

7. Emergency Bypass: If the DCM fails, quickly getting a usable sound path is as easy as flipping a switch. A front panel bypass switch provides the projectionist a simple Emergency Bypass. A passive crossover has been built into the center channel routing so that even with a total loss of power to the DCM, a usable sound path will be maintained. Activation of this bypass is done by the projectionist via a front panel Emergency Bypass switch.

8. Surround Insert Connections: To accommodate multichannel surround, the surround signals can be routed from the DCM to an external processor box (such as a Dolby SA-10) and back into the DCM for routing to the QSC amplifiers.

ILLUSTRATIONS- DCM-1

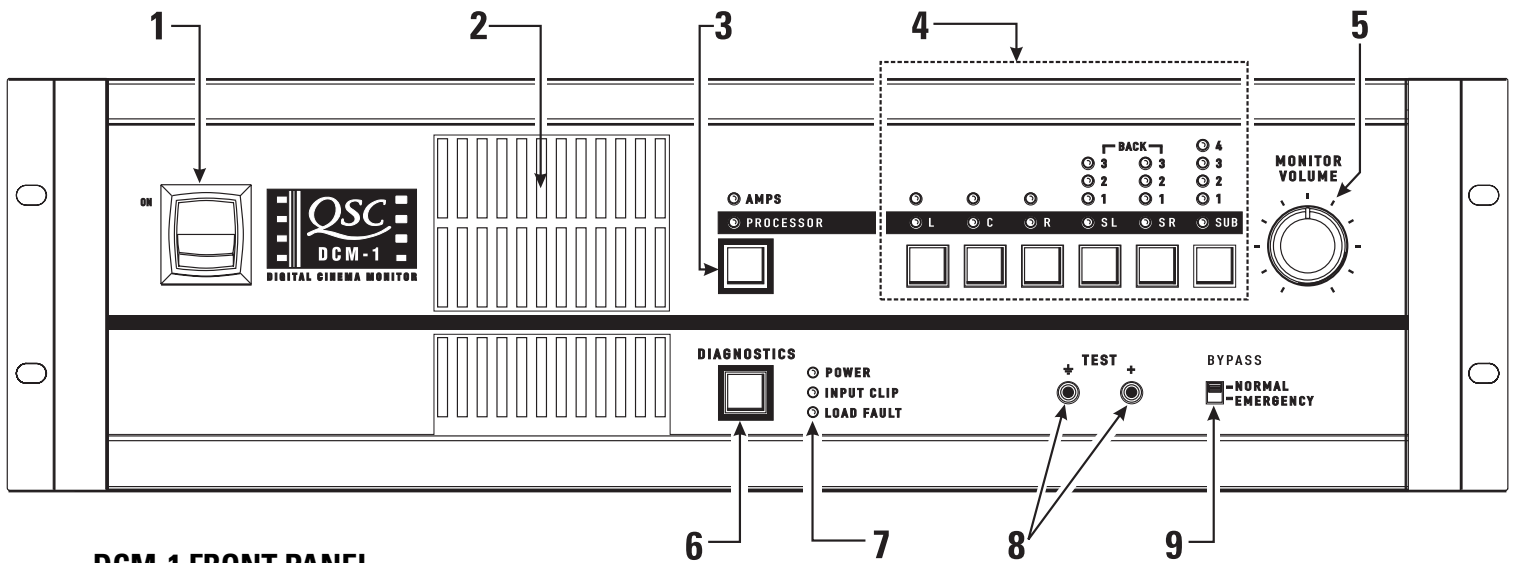

DCM-1 FRONT PANEL

- 1- Power switch
- 2- Monitor output speaker
- 3- Processor/Amps selector switch
- 4- Monitor source selector switches
- 5- Monitor volume control
- 6- Diagnostics check switch
- 7- Power "on" and diagnostics fault indicator LEDs
- 8- Monitor output test points
- 9- Bypass switch

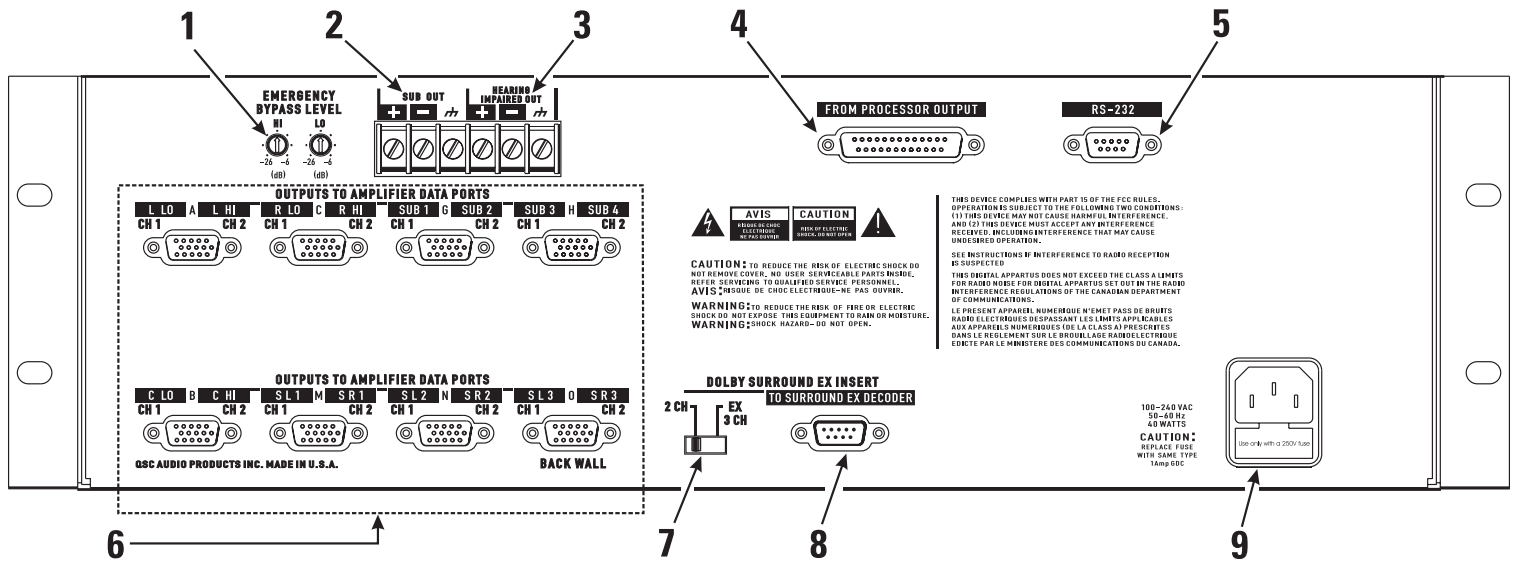

DCM-1 REAR PANEL

- 1- Emergency bypass level controls
- 2- Subwoofer output
- 3- Hearing Impaired system output
- 4- Audio input connector (from Cinema Processor)
- 5- RS-232 port
- 6- DataPort outputs to amplifiers
- 7- Dolby Surround selector switch
- 8- Output to Dolby Surround EX decoder
- 9- IEC-style power cord entry and fuseholder

ILLUSTRATIONS- DCM-2

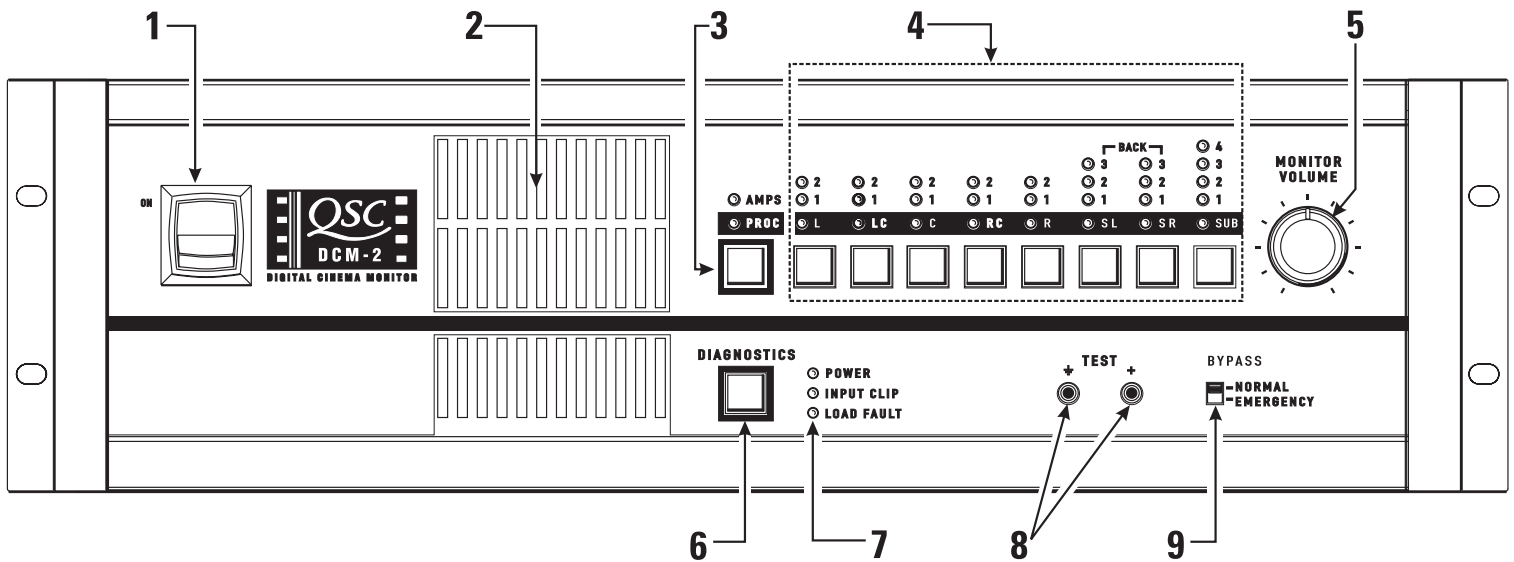

DCM-2 FRONT PANEL

- 1- Power switch
- 2- Monitor output speaker
- 3- Processor/Amps selector switch
- 4- Monitor source selector switches
- 5- Monitor volume control
- 6- Diagnostics check switch
- 7- Power "on" and diagnostics fault indicator LEDs
- 8- Monitor output test points
- 9- Bypass switch

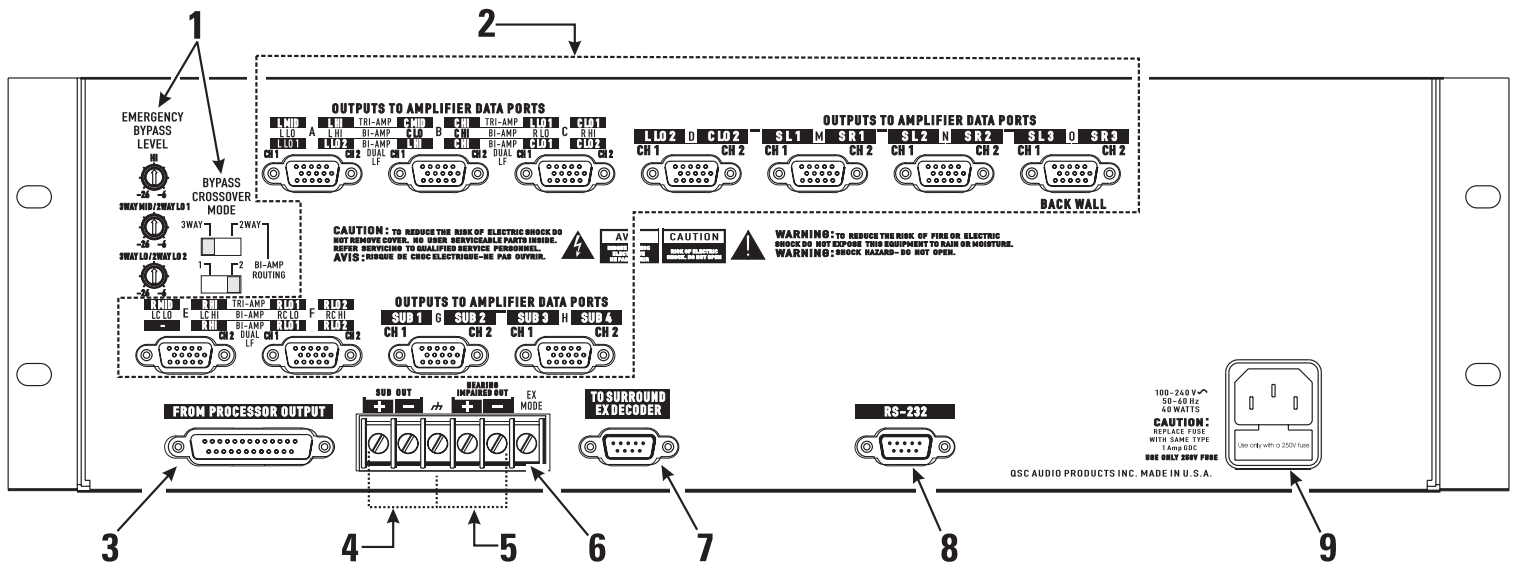

DCM-2 REAR PANEL

- 1- Emergency bypass level controls & bypass switches
- 2- DataPort outputs to amplifiers
- 3- Audio input connector (from Cinema Processor)
- 4- Subwoofer output
- 5- Hearing Impaired system output
- 6- Surround "EX" mode remote on/off input
- 7- Output to Dolby Surround EX decoder
- 8- RS-232 port
- 9- IEC-style power cord entry and fuseholder

ILLUSTRATIONS- DCM-3

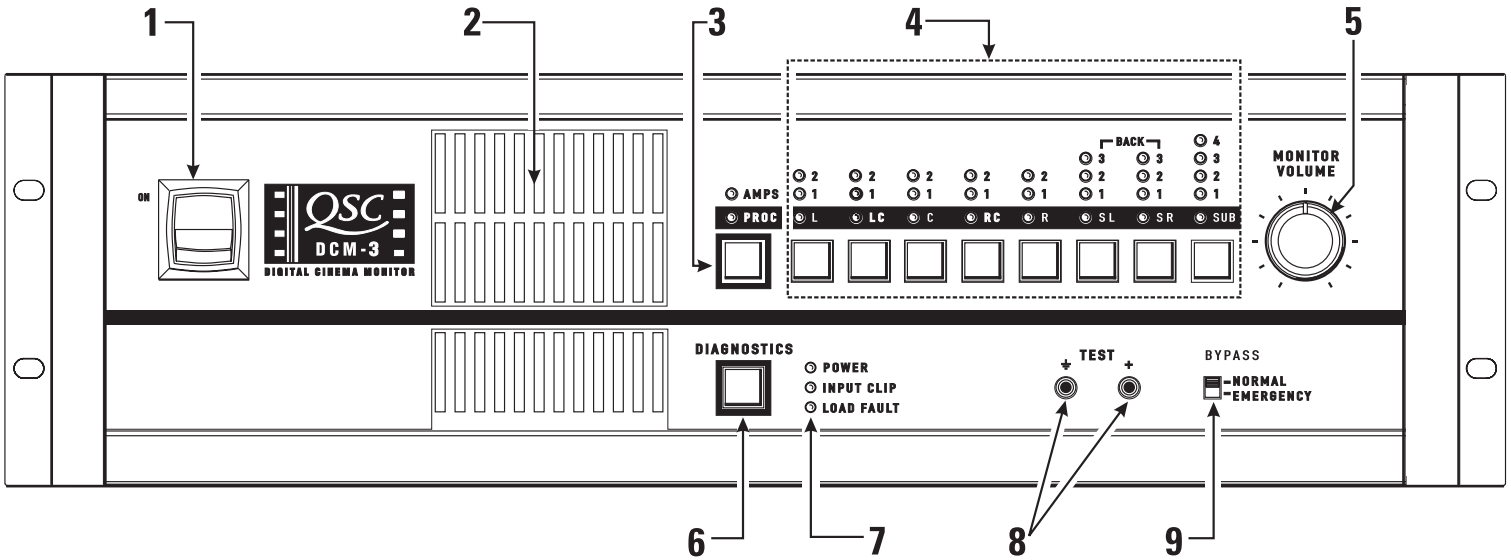

DCM-3 FRONT PANEL

- 1- Power switch
- 2- Monitor output speaker
- 3- Amplifier/Processor selector switch
- 4- Monitor source selector switches
- 5- Monitor volume control
- 6- Diagnostics check switch
- 7- Power "on" and diagnostics fault indicator LEDs
- 8- Monitor output test points
- 9- Bypass switch

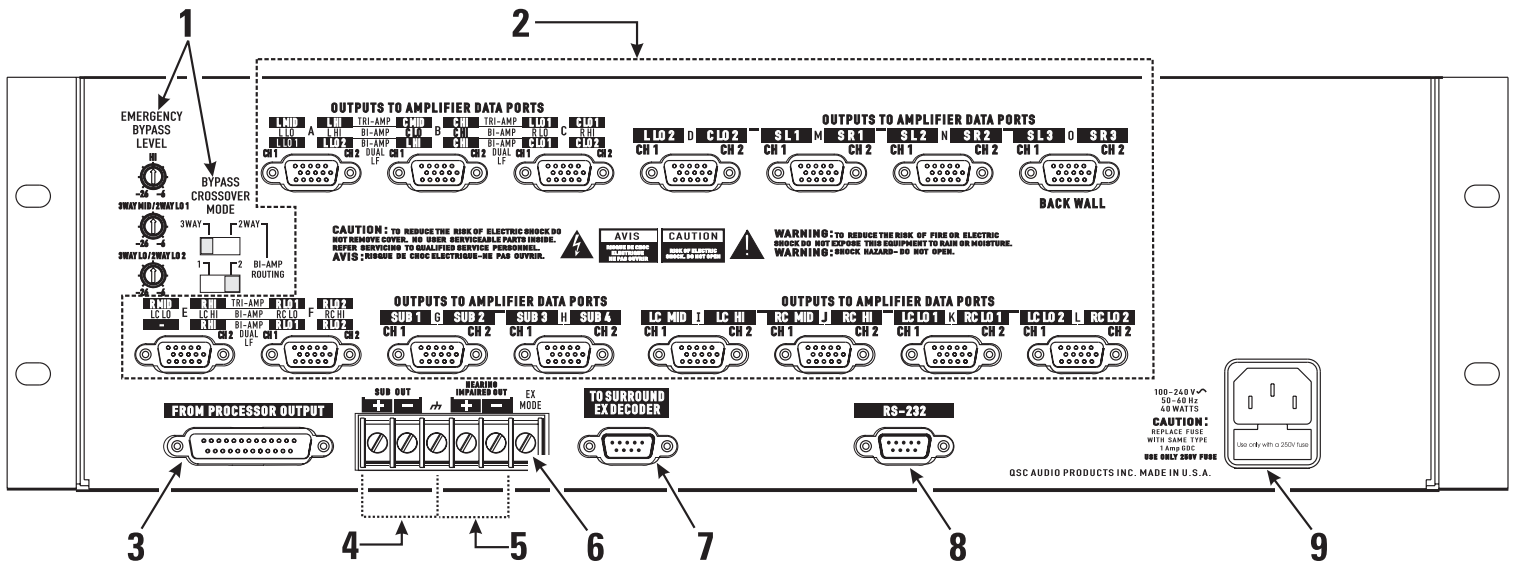

DCM-3 REAR PANEL

- 1- Emergency bypass level controls & bypass switches
- 2- DataPort outputs to amplifiers
- 3- Audio input connector (from Cinema Processor)
- 4- Subwoofer output
- 5- Hearing Impaired system output
- 6- Surround "EX" mode remote on/off input
- 7- Output to Dolby Surround EX decoder
- 8- RS-232 port
- 9- IEC-style power cord entry and fuseholder

HARDWARE DESCRIPTION- Front Panel

FRONT PANEL

The front panel of the DCM series resembles traditional cinema monitor products. This provides the projectionist a well known and easy to understand interface.

Power Switch: The power on/off switch is the master control for the DCM and the amplifiers connected to it. Amplifiers must be connected to the DCM with DataPort cables and power switches must physically be in the "on" position. The DataPort connection to DCA amplifiers have a standby control pin which provides standby control. QSC's DCA amplifiers feature zero inrush current, requiring no additional start-up sequencing. Center channel amplifier standby power control can be bypassed using the BYPASS switch, see settings, below.



The Emergency Bypass switch setting alters the Power Status of the Center Channel amplifier.

BYPASS switch set to NORMAL



The Power Status of all amplifiers connected to the DCM DataPorts will respond to the DCM power switch. When the switch is in the ON position, all the amplifiers will be on. When the switch is in the off position, all the amplifiers will be in Standby mode.

BYPASS switch set to EMERGENCY



Same as above EXCEPT that Center Channel (DataPort B & C) will remain on even if the DCM Power switch is set to the off position. For the DCM-1 only DataPort B remains on.

Monitor Output Speaker: The front panel speaker provides direct monitoring of the processor and amplifier output audio signals. The Processor/Amps and Monitor source selection switches determine what is being monitored and the Monitoring Volume control determines the speaker's output level.



The front panel TEST connections provide the same signal used to drive the Monitor Speaker prior to the gain potentiometer (pre-fader). TEST signal levels are the same level as the cinema processor output signals (unity gain) and can be used for system calibration.

AMPS/PROC Selector Switch: The AMPS/PROC switch determines the function of the Monitoring Select buttons, to the right of the AMPS/PROC switch. The LEDs directly over the PROC/AMPS switch indicate what selected function the Monitor Select buttons will have. When the PROC LED is illuminated, the Monitor Select buttons will select or deselect the various Cinema Processor inputs to the DCM for monitoring. When the AMPS LED is illuminated, the Monitor Select buttons select or deselect amplifier outputs for monitoring. After the AMPS/PROC choice has been made, the individual channel buttons determine exactly which signals are routed to the front panel monitor speaker.

HARDWARE DESCRIPTION- Front Panel

FRONT PANEL (continued)

Monitor Source Selection Switches: Pressing any of the Monitor Select buttons will either select or deselect the corresponding (marked) signal for monitoring. Each button can select either the Processor signals (input to the DCM) or the Amplifier signals (output to the speakers), depending on the current selection of the PROC/AMP switch.

LEDs provide confirmation of the active monitor source for each of the cinema channels. If no LED is illuminated when a channel is selected, there is no monitoring of that channel.

Processor monitoring is very simple. Select the **PROC** position and then select the desired L, LC, C, RC, R, SL, SR, or SUB position. Amplifier monitoring includes selections for the L, LC, C, RC, R channels (just like the **PROC** selections), but offers additional monitoring of all of the additional amplifier outputs.

There are 3 Surround Left (SL) and Surround Right (SR) DataPorts available for amplifier connection to drive the speakers on the theater side walls. These are able to create three distinct “zones” where volume controls can be adjusted. One typical installation would be to connect the SL1 and SR1 signals to the speakers closest to the screen, SL2 and SR2 in the next set of speakers further away from the screen and the SL3 and SR3 connections furthest back in the theater. In Surround Decoder applications, the SL3 / SR3 setting monitors the speakers on the backwall. Other installations might require speaker sets where some speakers are along the theater side walls while other speakers are under a balcony overhang. By connecting these speakers as “zones”, the sound levels will be much easier to balance.

Any of these amplifier outputs can be verified by selecting them to be routed to the DCM monitor speaker. The DCM also has 4 Subwoofer outputs. Each of these outputs can be individually selected for monitoring on the front panel speaker. The front panel monitoring logic allows combining amplifier channels to verify individual signals or combinations of signals.

NOTE: All combining of the individual frequency outputs (2-way or 3-way) is done automatically, so all front panel monitoring is of a full frequency signal.

Monitor Volume: The Monitor Volume control is used to adjust the monitoring volume from the front panel speaker.

- Rotating the control clockwise increases the volume.
- Rotating the control counter-clockwise decreases the volume.

HARDWARE DESCRIPTION- Front Panel

FRONT PANEL (continued)

Diagnostics Check Button and Indicators: The Diagnostics / Indicator section includes an extremely simple method of verifying proper system operation and performing basic troubleshooting.

The **Power** LED shows whether the DCM unit is on or off.

The **Input Clip** LED is helpful in verifying that the cinema format processor is not over-driving the DCM input circuitry.

The **Load Fault** indicator is a unique and powerful feature which verifies that signal inputs into the DCM actually make it through the DCM, the DataPort cables, and the amplifier unit all the way to the speakers, and that the speaker connections are not electrically shorted or open. All of these measurements are being performed constantly (without user action) on ALL output channels and any unusual readings will light the **Load Fault** LED. If the **Load Fault** LED is lit, pressing the **Diagnostics** button (and holding it pressed) will cause the problem channel's indicator LED to light. This information will let you inspect the system cabling for that channel and troubleshoot the problem.

There are two types of indication: If the **PROC** LED and **AMP** LED are on, there is no amplifier detected at that DCM amplifier connector. If the **AMP** LED is on, the amplifier on at that output is measuring a short or an open on its output terminals.

REMEMBER: If you configured the DCM Manager software to not have certain channels (for example there is no SUB 3 or SUB 4) or have not assigned a QSC amplifier to a channel, these channels WILL NOT indicate any faults.



LOAD FAULT INDICATOR NOTE: The DCM's Load Fault detection scheme uses a complex averaging algorithm which compares input signals to output signals and measures voltage and current on all amplifier outputs. To sense real world conditions, these measurements must be found to be "out of range" many times before the Load Fault condition is indicated on the front panel. If you are simulating fault conditions, you MUST have a "real-world" signal level through the device (full signal input), and the fault condition must exist for several minutes before the front panel Load Fault LED will light. This extra fault verification time eliminates false triggering which would be confusing to a user. In conclusion, *Just shorting the output terminals will NOT cause the fault LED to light*, the unit must be driven by real-world input signals and the fault must persist for several minutes.

HARDWARE DESCRIPTION- Front Panel

FRONT PANEL (continued)

Test Jacks: The **Test** jacks give you access to any of the signals being sent to the front panel speaker (before the gain potentiometer). These signal levels are at the exact same level as the cinema processor output signals (unity gain) and can be used as a test point for system calibration.



Emergency Bypass: This is an extremely powerful feature. If there should ever be a problem with the DCM or system cabling, you have the ability to bypass all of the DCM active circuitry and get sound to the center channel. In the **NORMAL** position, the DCM performs normal monitor and crossover functions. In the **EMERGENCY** position, the PROC center channel signal is routed to a passive crossover (no power is required), and then to the center channel amplifier. There are level adjustments on the rear panel for balancing the high frequency and low frequency output level.

BYPASS



HARDWARE DESCRIPTION- Rear Panel

REAR PANEL

Amplifier DataPorts: One QSC amplifier DataPort includes all connections required to send two channels of audio from the DCM to the amplifier input circuitry, and current and voltage information back from the two speaker terminal outputs. Also included on this connector is remote on/standby control of the amplifier which allows the DCM to act as a master system power controller.

Custom-length DataPort cables with individually shielded-pair construction are available from QSC's Technical Services Group.

The maximum output configuration on the DCM-1 is a 6 ch / 2-way, the maximum on the DCM-2 is a 6 ch / 3-way, and the maximum output configuration on the DCM-3 is a 8 ch / 3 way. In addition, many parallel outputs (with separate processing) are included for additional theater configuration flexibility.

The rear panel labeling on the DCM has all of the information required by an audio installer. When starting, write down the EXACT SPEAKER CONFIGURATION (for example, 8 channel, Tri-amp with 3 surrounds and 4 subs). Now you can follow the rear panel text which shows both channel position (L or C or R, etc) and the frequency output (LO, MID, HI, etc). Connect the L-LO output to the correct amplifier driving the left positional speaker's low frequency transducer, and L-HI to the amplifier driving the same speaker's high frequency transducer, etc.



WARNING: Incorrect frequency connections can damage transducers. Physically verify proper connections AND listen to each individual transducer at very low volume before applying full audio power.

TYPICAL DCM DATAPORT LABELING (DCM-2 shown)-

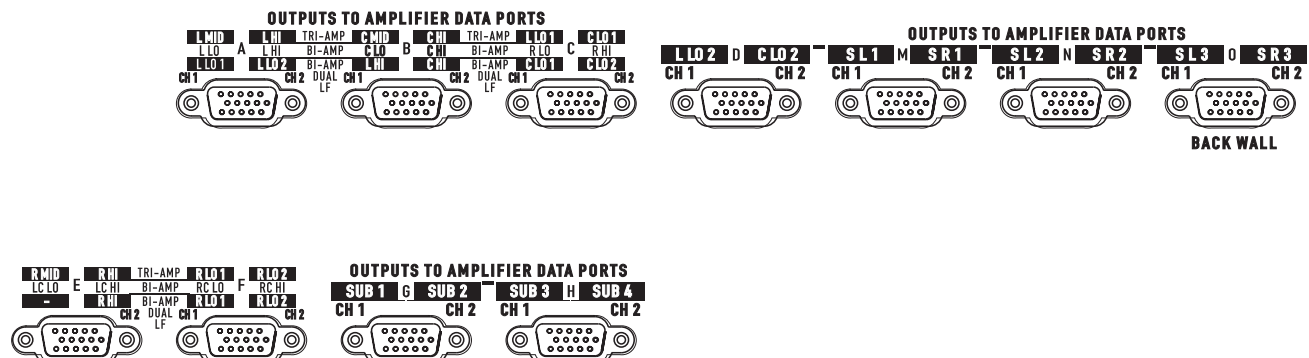

HARDWARE DESCRIPTION- Rear Panel

REAR PANEL (continued)

From Processor Output: This connection is from the cinema processor, and is the input source of all film sound into the DCM unit. The 25-pin connector is an industry standard type and pinout, and will connect into your system very easily. These cables are available from several cinema supply houses.

RS-232 Connection: This connects to the RS-232 serial port on the host PC. All of the crossover functions and many other features can be viewed and modified using the DCM Manager control software. Communication between the DCM and the PC is done through this connection.

Surround Insert: The insert connector offers an extremely simple method of routing the surround signals out of the DCM to an external processor box, and then back into the DCM for further routing and monitoring.

Emergency Bypass Levels and Routing: These are used to adjust the passive crossover used by the Emergency Bypass feature. The signal level of the passive crossover outputs sent from the DCM to the center channel amplifiers can be adjusted to best suit the center channel transducer sensitivities. This signal path is only active if the front panel Bypass switch is in the Emergency position. The **BYPASS CROSSOVER MODE** switch (DCM-2 and DCM-3 only) internally routes the Center channel input signal through the 2-way passive crossover or the 3 way passive crossover.

The **BI-AMP ROUTING** switch (DCM-2 and DCM-3 only) routes the center channel low signal through CH1 of DataPort B when in position "1", or routes the center channel low signal through CH2 of DataPort C when in position "2". The switch is not active when the **BYPASS CROSSOVER MODE** switch is set to "3WAY".

FROM PROCESSOR OUTPUT

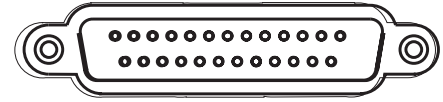

RS-232

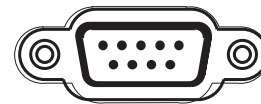

TO SURROUND EX DECODER

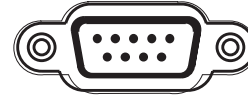

EMERGENCY BYPASS LEVEL

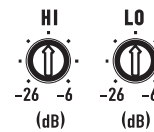

EMERGENCY BYPASS LEVEL

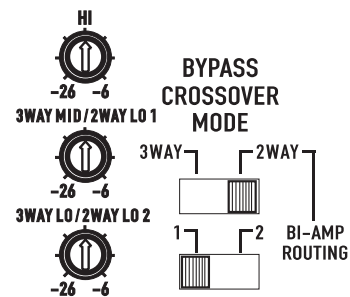

HARDWARE DESCRIPTION- Rear Panel

REAR PANEL (continued)

Terminal Strip Connections: The terminal strip includes convenient connections for output to a powered subwoofer, a **Hearing Impaired** audio output, and on the DCM-2 and 3, a remote control on/off logic connection (**EX MODE**) for the surround decoder system.

SUB OUT provides the exact same signal as the subwoofer output used on DataPort G. It is assumed that you use either DataPort G **or** the terminal strip connection, but **not both** at the same time. This connection cannot be monitored or include any of the Fault Analysis functions because there are no connections *back* from this external speaker.

HEARING IMPAIRED OUT is a single mono audio output which contains a mix of the L, C, and R positional signals (Center = +6db compared to L&R). This is usually connected to a special cinema system which supplies headphones to people with hearing difficulties. This can also be used as an input signal to a powered speaker for remote monitoring of basic L/C/R signals in larger projection booths.

EX MODE- On the DCM-2 and 3, this connection on the terminal strip allows a remote on/off signal to come from an external surround decoder. This routes the surround signals (I/O) to the **“TO SURROUND EX DECODER”** connector or directly to the DCM DataPort connections.

IEC-type AC Power Cord Receptacle: The power receptacle accepts a standard IEC power cable. The DCM uses a switching power supply that accepts a wide range of AC voltage. 85 to 260 VAC (50/60 Hz.) is the acceptable AC voltage. The IEC connector also houses the fuses for the DCM.



If fuse replacement is required, use only Littlefuse #218 001 or Bussman #S5504-1A.

DCM-1 Terminal Strip Connections

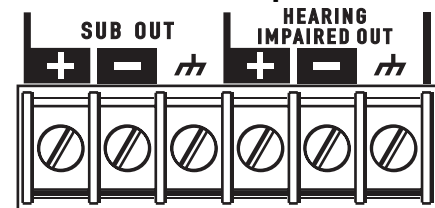

DCM-2 and -3 Terminal Strip Connections

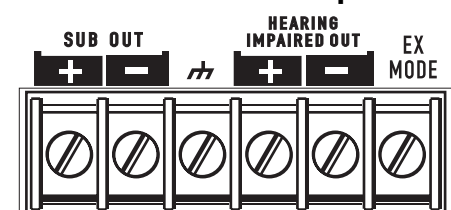

100-240 V 
50-60 Hz
40 WATTS
CAUTION:
REPLACE FUSE
WITH SAME TYPE
1 Amp GDC
USE ONLY 250V FUSE

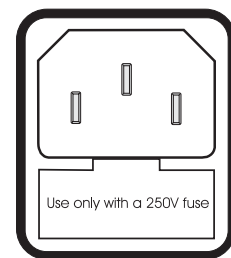

SOFTWARE DESCRIPTION

DCM MANAGER WINDOWS SOFTWARE

To access the powerful crossover and system calibration functions of the DCM hardware, you must use the *DCM Manager* control software. A 9-pin male to female serial data cable is also needed to connect your PC to the DCM. One of the computer's available COM ports (RS-232) provides communications between the *DCM Manager* software and the DCM hardware. The PC must meet the minimum System Requirements outlined on page 5.

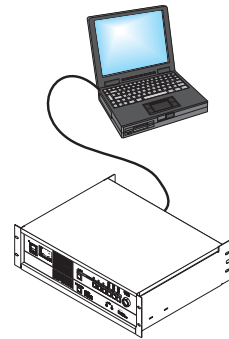

A typical cinema installation should require this setup procedure **ONLY** during the initial installation of the system. One particular advantage of the *DCM Manager* software and DCM hardware is the ability to calibrate one DCM-based cinema system and easily download ALL of these settings to any number of additional DCM units in venues that are similarly equipped.

To aid in calibrating the crossover settings, the *DCM Manager* control software includes a database including many well known cinema speakers. This data will automatically set the DSP filters and transducer alignment delay settings within the DCM hardware according to the settings recommended by the speaker manufacturer for optimum sound performance. Select speakers for each of the physical locations (L,C,R, SL, SR, SUB), and a large portion of the system calibration is finished!

NOTE: QSC updates these files regularly as new models are introduced from speaker manufacturers or settings are improved. Visit our website <http://www.qscaudio.com> for the latest cinema products information and technical support.

SOFTWARE INSTALLATION

- Start the PC.
- Exit any programs that may be running.
- Insert the QSC DCM Manager CD in the CD-ROM drive and close the drive.
- The installation routine will automatically start. Follow the instructions on screen.
- If the install does not automatically start, select Run from the Windows Start menu, specify the appropriate drive and select DCMsetup.exe; the installation routine will start.

STARTING THE PROGRAM

- Connect the 9-pin serial data cable between the PC and the DCM.
- When the software is installed, a *DCM Manager* icon is placed on your computer's desktop. Double-click on this icon to launch the *DCM Manager* program.
- The *DCM Manager* program can also be launched using the Windows Start/Programs selection.

USING THE DCM MANAGER SOFTWARE

- After launching the *DCM Manager* program, click on the Help menu item for a full-featured software help system.

INSTALLATION- Rack Mounting

RACK MOUNTING

Rack mounting of the DCM is optional. Four, self-adhesive rubber feet are included with your DCM for non-rack mount applications. If using the DCM in non-rackmount applications, we recommend the rubber feet be installed on the bottom of your DCM to minimize the chances of scratching any supporting surface. To use the self-adhesive feet: peel off the protective backing from the foot, place near one of the corners on the bottom, and press firmly to activate the pressure-sensitive adhesive.

If rack mounting the DCM, secure the DCM to the rack rails using four machine screws and washers of the proper size. Most US rack equipment accepts #10-32 machines screws; length used depends upon application. The DCM will require 3-RU (rack units) of space.

To rack mount your DCM:

- 1- select mounting location
- 2- have an assistant support the DCM in its mounting location
- 3- secure the two bottom screws first; do not fully tighten yet
- 4- secure the top two screws, do not fully tighten yet
- 5- "fine tune" the DCM up, down, right, or left as required and tighten the four mounting screws

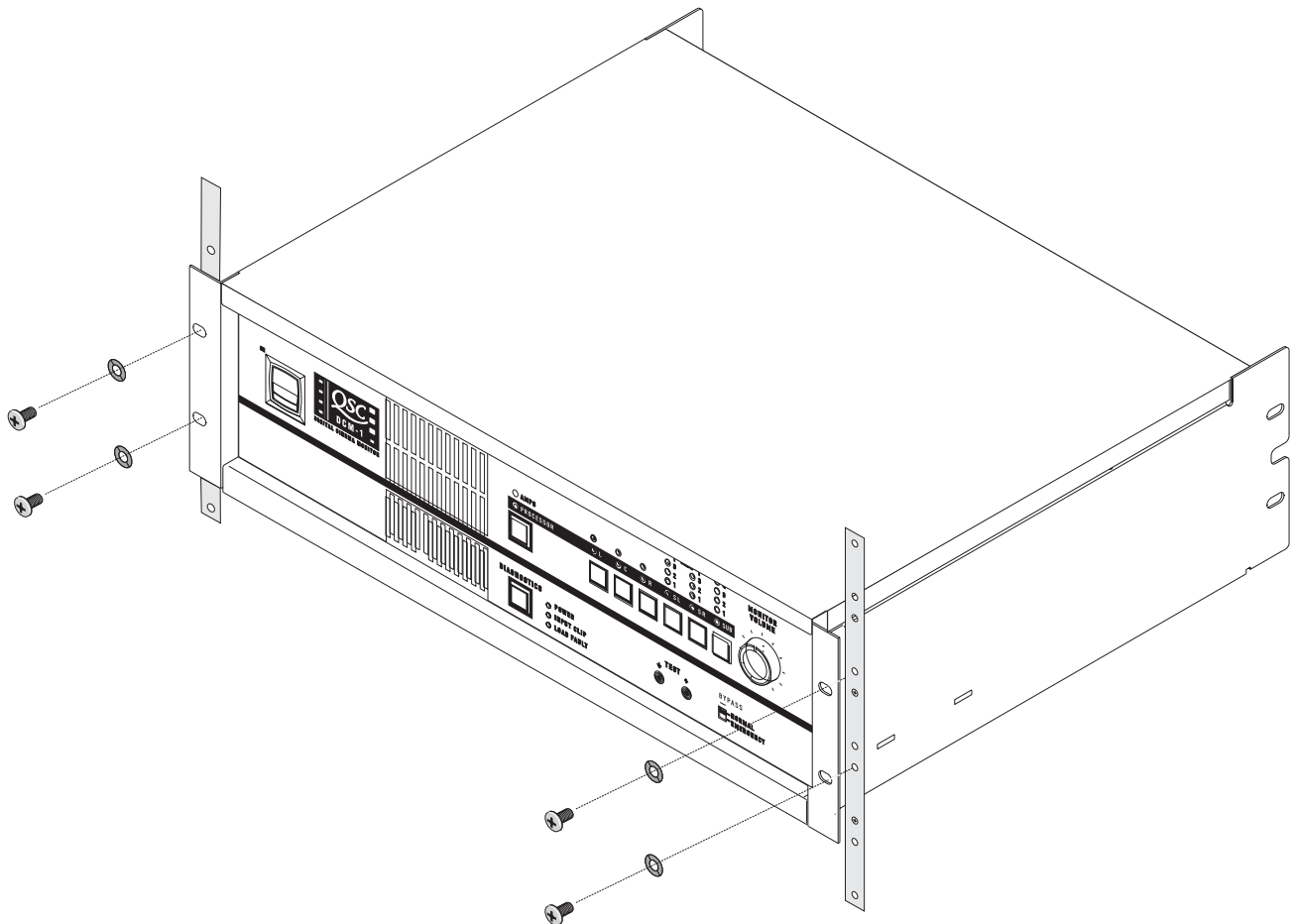

INSTALLATION- Rear Rack Ears (optional accessory)

SUPPORTING THE REAR OF THE DCM (requires optional hardware)

For mobile and touring use, it is extremely important to support the rear of the DCM. The chassis and rack can be damaged if the DCM is not properly supported. Unless the DCM is being installed in its final, fixed location, QSC strongly recommends supporting the rear of the unit. Rear rack ears, required hardware, and a separate instruction sheet are available from QSC's Technical Services Group (part number FG-000031-00).

Attaching Rear Rack Ears

Method 1

The DCM is first installed from the front of the rack and secured to the front rack rails. The rear ears are then secured to the DCM using two machine screws. The ears are secured to the rails using regular rack hardware.

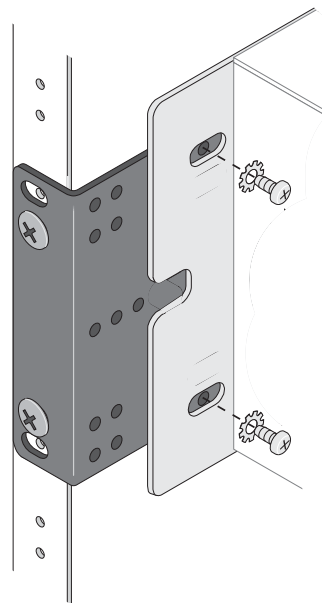

Method 2

The DCM is first installed from the front of the rack and secured to the front rack rails. Temporarily secure the rear ears to the rear rack rails and select the appropriate mounting position for the "pin". Remove the rear ears and install the locator pins securely. Use of thread-locking is recommended for high-vibration installations.

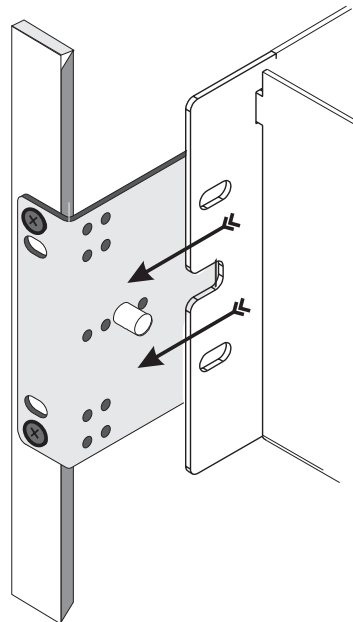

INSTALLATION- Connections: General Information and AC Mains

CONNECTIONS

Making the required connections to the DCM is simple. Just make sure that you have all of the correct cables. “Mass-termination” connectors are used wherever possible. This reduces installation time from hours to minutes and makes any required connection changes fast, easy, and reliable.

REQUIRED CABLES (typical system)

- 1- IEC-style AC power cord (included with the DCM)
- 2- QSC DataPort cable for every amplifier (8, 11, or 15 cables depending upon model)
- 3- Cinema Processor cable (DB25 male-male)
- 4- RS-232 cable (DB9 male-female, used only during setup with the DCM Manager software)
- 5- Surround EX Decoder cable
- 6- Shielded audio cable for Hearing Impaired and Powered Subwoofer outputs (if used)

AC MAINS CONNECTION

Before plugging your DCM into the AC mains, verify proper operating voltage. The serial number sticker located on the rear of the DCM has the rated operating voltage information printed on it. Locate the sticker, note the rated voltage, and ensure the AC circuit you intend to use is properly rated.

Locate the IEC-style AC power cord supplied with your DCM. Identify the “IEC” end (molded plastic block), line it up with the rear panel IEC receptacle, and insert it fully.

Plug the AC plug end of the cable into a functioning AC outlet of the proper voltage.

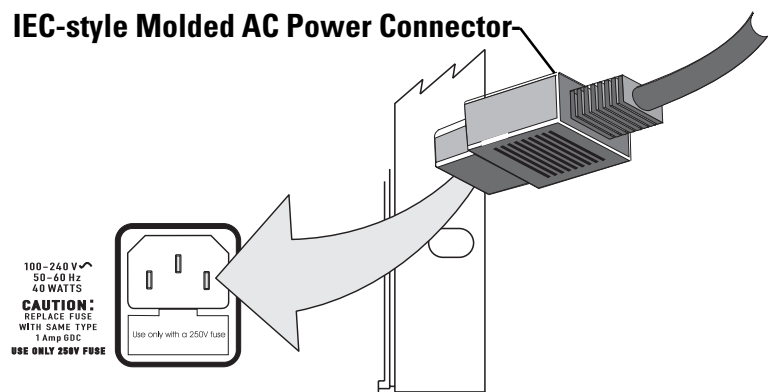

The DCM is equipped with a detachable IEC-style AC power cord. To reduce the risk of accidental disconnect, secure all power cords in the course of installation.

INSTALLATION- Connections: RS-232

RS-232 CONNECTION

The RS-232 port is used only for setup and system troubleshooting. Connect the 9-pin serial data cable from the host PC to this connector on the DCM. Orient the male DB9 connector to match up with the RS-232 port, push the connector into the receptacle to seat it, and finger-tighten the retaining screws. Do not use "null-modem"-type serial data cables; they will not work with the DCM. Use a "normal" 9-pin serial data cable.

The other end of the 9-pin serial data cable must be connected to an available RS-232 port on the host PC. The PC must have QSC's DCM Manager software installed on its hard drive. Start the DCM Manger program and verify RS-232 communication between the PC and DCM. Refer to the DCM Manager software help system for details.

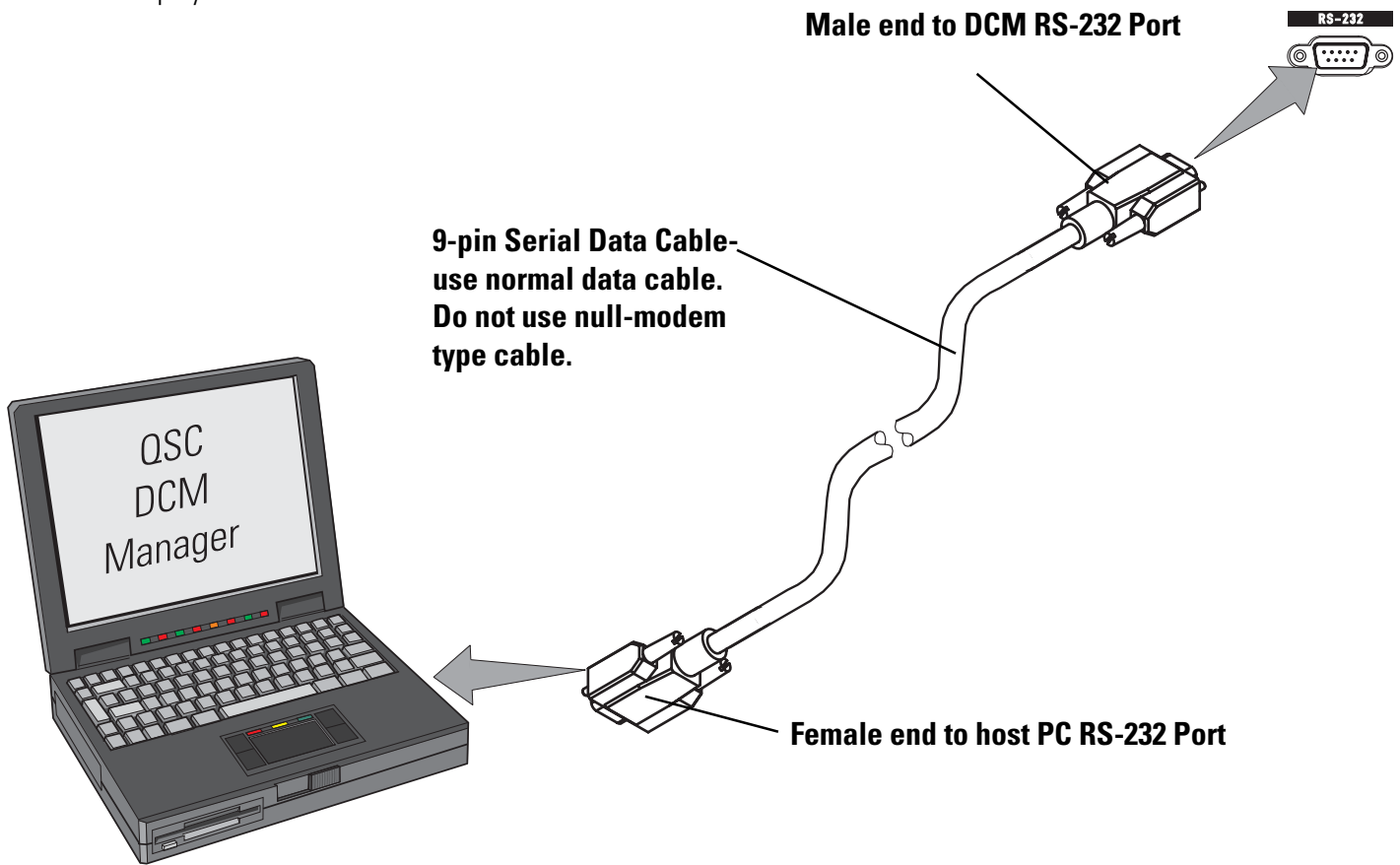

RS-232 Pinout-

Configuration: 9-pin SubD male to 9-pin SubD female normal serial data cable.

Pin#	Signal Description
1	Loopback
2	Transmit
3	Receive
4	Loopback
5	Digital Ground
6	Loopback
7	Clear to Send
8	Request to Send
9	(not used)

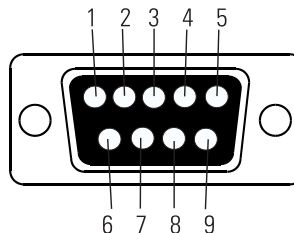

INSTALLATION- Connections: DataPort

DATAPORT CONNECTION

The QSC DataPort connection carries input signals, amplifier output monitoring signals, remote amplifier power on/standby control, amplifier temperature, and more, all on one cable. Each DataPort is clearly marked indicating which channel's amplifier it should be connected to. Follow the back panel labeling. Connect each DataPort to its respective amplifier's DataPort. Finger-tighten the retaining screws on the cable connectors; do not overtighten!

Connect a DataPort cable from each of the DCM's DataPorts to each of the system's DCA amplifiers.

Orient the cable's HD15 male connector properly and push the connector onto the DCA's receptacle. Finger-tighten the retaining screws to ensure reliable connection. Connect the other end of the cable to the DataPort on the corresponding channel's DCA amplifier.

DataPort Pinout-

Configuration: 15-pin SubD (high-density) male to 15-pin SubD (high-density) male.

Pin #	Signal Description
1	Ch. 1 Minus (-) Signal
2	AC Standby Control
3	V- MON Ch. 1 and Subcode 1
4	I- MON Ch. 1 and Subcode 2
5	Clip/Protect Ch. 1
6	Hard Ground
7	Ch. 1 Plus (+) Signal
8	Ch. 2 Plus (+) Signal
9	+15V from Amplifier
10	Data Reference Ground
11	Ch. 2 Minus (-) Signal
12	Amplifier IDR (Model ID)
13	V- MON Ch. 2 and Subcode 3
14	I- MON Ch. 2 and Subcode 4
15	Clip/Protect Ch. 2

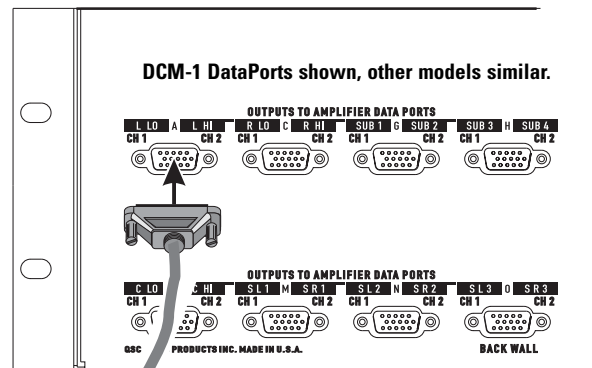
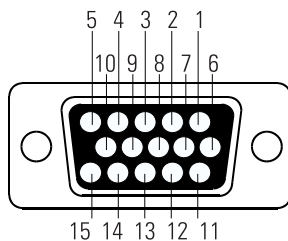

QSC DataPort Cable

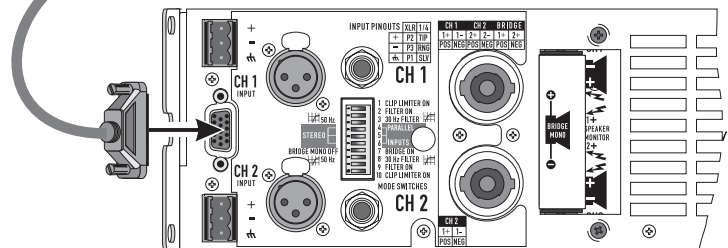

Use QSC DataPort cables. Contact QSC's Technical Services Group if you would like to purchase standard length DataPort cables or specially made custom length cables that use shielded audio-pairs for the best possible performance.

INSTALLATION- Connections: Cinema Processor

CINEMA PROCESSOR CONNECTION

Audio signals are input to the DCM via the FROM PROCESSOR OUTPUT connection. This DB25-type connection conforms to cinema industry standard pinout. Most common cinema processors use this DB25 connection standard, making connection to the DCM simple. Orient the DB25-type connector properly, push gently to seat the pins, then finger-tighten the retaining screws.

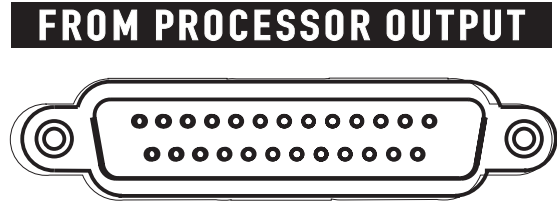

Cinema processors that do not use standard DB25-type connection typically have adapter cables available. Check with the processor manufacturer. We recommended that you purchase a standard 25-pin cable from any of the well known cinema industry cable suppliers.

FROM PROCESSOR OUT Pinout-

Configuration: 25-pin SubD male to 25-pin SubD male.

Pin #	Signal Description
1	Chassis Ground
2	Left +
3	Left Center -
4	Chassis Ground
5	Center +
6	Right Center -
7	Chassis Ground
8	Right +
9	Chassis Ground
10	Surround Left -
11	Surround Right -
12	Subwoofer -
13	Chassis Ground
14	Left -
15	Chassis Ground
16	Left Center +
17	Center -
18	Chassis Ground
19	Right Center +
20	Right -
21	(not used)
22	Chassis Ground
23	Surround Left +
24	Surround Right +
25	Subwoofer +

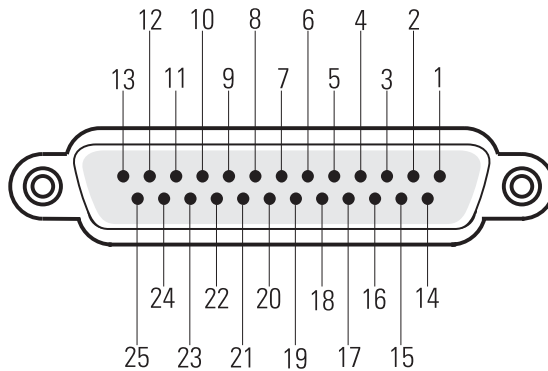

INSTALLATION- Connections: Hearing Impaired, Powered Subwoofer

HEARING IMPAIRED CONNECTION

The Hearing Impaired output signal is available on the screw terminal connector on the rear of the DCM. The output signal is similar to levels that are output from a standard CD player.

Output Level

-11.8 dBu
(200 mVrms)

Impedance

50 ohms
(±5%)

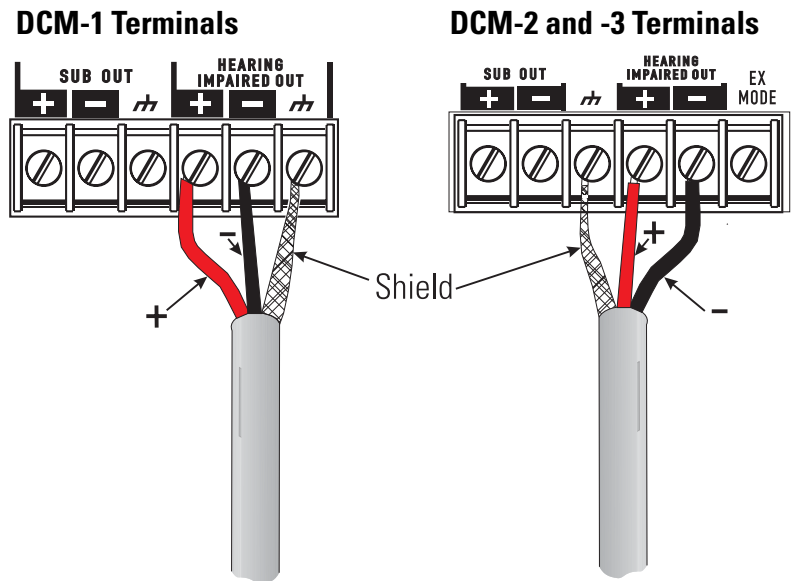

Connect other end of cable according to equipment manufacturer's instructions.



Use balanced audio connections and high-quality, shielded, balanced audio cable for interconnecting the DCM and Hearing Impaired equipment. Balanced connections are less prone to noise pick-up than unbalanced connections.

POWERED SUBWOOFER CONNECTION

Screw terminal connections make it possible to send a balanced signal to a powered subwoofer. This signal is balanced and the circuitry is designed for long cable runs from the projection booth to the theater screen. The high-pass filtering and level adjustments are done by the DCM unit.

NOTE: There will be no fault analysis or output audio monitoring available for the sub channel signal if this connection is used.

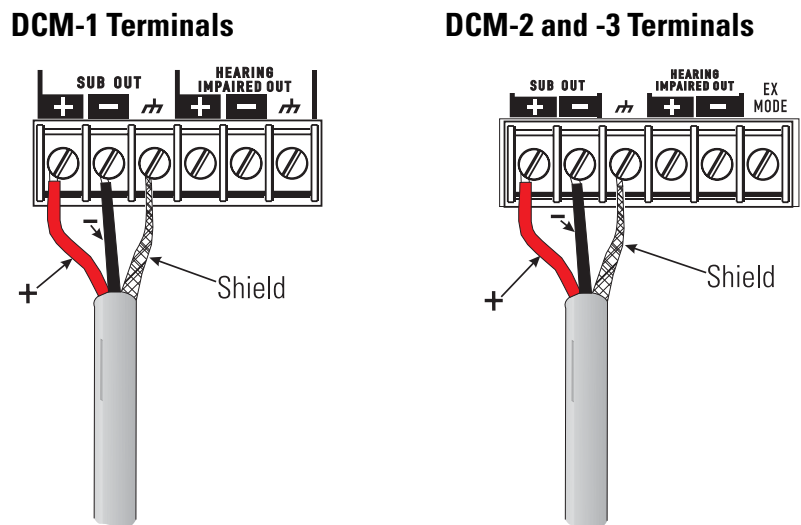

Connect other end of cable according to equipment manufacturer's instructions.



Use balanced audio connections and high-quality, shielded, balanced audio cable for interconnecting the DCM and Powered Subwoofer equipment. Balanced connections are less prone to noise pick-up than unbalanced connections.

INSTALLATION- Connections: Surround Insert

SURROUND INSERT CONNECTION

Surround insert connections are provided for connection to a Dolby Surround Processor. The surround insert connections are made using the TO SURROUND EX DECODER connection.

Connect a cable between this connector and an external processor such as the Dolby SA-10. Signals will be routed out of the DCM to the processor and back into the DCM for output to the amplifiers.

DCM-1 Surround Insert Connector and Selector Switch



DCM-2 and -3 Surround Insert Connector



TO SURROUND EX DECODER Pinout-

Configuration (typical): 9-pin SubD female on DCM end to loose wires attaching to surround processor's terminal strip inputs and outputs

Pin#	Signal Description
1	Surround Left Send
2	Surround Right Send
3	Signal Ground
4	Surround Left Return
5	Surround Right Return
6	Signal Ground
7	Signal Ground
8	Surround Back Left Return
9	Surround Back Right Return

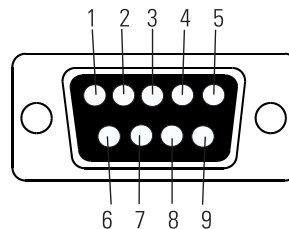

INSTALLATION- System Calibration

SYSTEM CALIBRATION

When installing a typical cinema sound system, most of the calibration involves the Cinema Processor. Refer to the user manual for the Cinema Processor that you are using.



WARNING: Turn the Gain Controls on all of the system's amplifiers all the way down until crossover settings and levels are verified!

Connect a PC computer to the RS-232 connector, turn on the DCM unit, load the DCM Manager software and either load a full configuration file (if this theater uses the exact same settings as another theater), or select and enter all of the new data.

The General, Amp, Speaker, and DSP Settings tabs must all be set correctly and downloaded to the DCM for the system to function properly.

Once all system and crossover settings are correct in the DCM Manager software, you are ready to start calibration.

1. Theater - audio level adjustments

The combination of QSC amplifiers and speakers contained in the DCM Manager database will require little or no DCM adjustment. Transducer sensitivity imbalances within the speakers have been compensated for by the factory recommended crossover settings. If you are using a powered subwoofer, or a speaker not contained in the factory supplied speaker database, you may need to make level adjustments.

2. Emergency Bypass Levels

When the emergency bypass switch on the front panel of the DCM unit is activated, a passive crossover is used to divide the center channel audio signal into either a 2-way signal (high frequency and low frequency), or a 3-way signal (DCM-2 and DCM-3 only). The relative volumes of these signals can be adjusted on the rear panel of the DCM unit. Feed pink noise into the center channel input, compare the center channel sound while the front panel switch is in the **Normal** position to the sound while in the **Emergency** position. While in the bypassed position, adjust the potentiometers to most closely match the normal position sound.

DCM-1 Bypass Level Controls

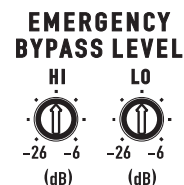

DCM-2 and -3 Bypass Level Controls

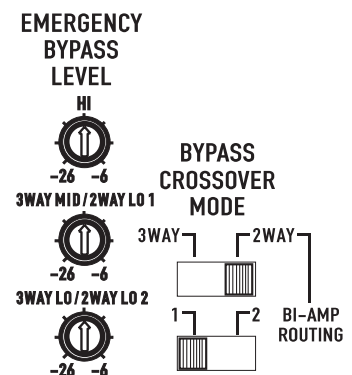

INSTALLATION- System Calibration

3. Monitoring - audio mix adjustments

The DCM Manager software allows balancing of the high/low or high/mid/low signals being fed to the front panel monitor speaker. Input pink noise into all of the DCM input channels and select individual channels using the DCM front panel buttons.

Select the surround channels first to make a reference level (the DCM contains no processing of these channels). Now select other channels one at a time and balance these gain settings for a sound level similar to the surround channels.

4. Speaker Frequency adjustments

The manufacturer of any loudspeaker will be able to supply you with recommended crossover settings. The DCM offers additional filters (high pass, parametric EQ, screen EQ, and Horn EQ), driver and channel delay, polarity, and gain adjustments which can be used as additional compensation for speaker and installation characteristics.



WARNING: Inappropriate crossover settings can damage speakers!

5. Setting Delay Times

Driver delay settings compensate for the physical displacement between transducer centers within one speaker. Consult the speaker manufacturer for help in determining this setting. Channel delay compensates for the distance that a speaker is located from the screen. We have included some screen delay adjustment, but most typical theaters will not need to use this because surround channels are delayed coming from the cinema processor. Consult an acoustic consultant for the proper calibration method, or experiment until the sound from the screen together with sound from the surround speakers sounds more “clear”.

TROUBLESHOOTING

If the DCM Manager program is unable to communicate with the DCM hardware...

- Verify the RS-232 cable connections. Re-seat each cable-end and finger-tighten connector retaining screws.
- Make sure the 9-pin serial data cable (RS-232 cable) is a normal type cable. "Null-modem" or other "special" cable will not work with the DCM.
- Try a known-good serial data cable, if possible.
- Verify the COM port selection in the DCM Manager program. Port selection is automatic, but it is possible that incorrect auto-selection is preventing communication.
- Confirm the serial port (COM port, RS-232 port) you are using is operating properly. Windows has provisions for checking hardware in the Windows Control Panel. Refer to the Windows help system for more information.
- Cycle the power of both the PC and the DCM.
- Check that no other program or utility is using the specified COM port.

If there is no audio from the front panel Monitor Speaker...

- Check the Monitor Volume control; it should be set to a useful level, not fully counterclockwise.
- Verify the desired active monitor source is selected by pressing the AMPS/PROC selector button and observing the illuminated LEDs beneath channels selected for monitoring. Select or deselect your desired monitor sources.
- Try just selecting the center channel of the Cinema Processor input (select PROC, then select C using the front panel push-button controls). If there is a center channel input signal connected to the FROM PROCESSOR OUTPUT connector on the rear of the DCM, it should be audible now. If not, continue with the next step.
- Verify the connections of the Cinema Processor cable. This is the cable that connects the Cinema Processor's outputs to the DCM's inputs (the FROM PROCESSOR OUTPUT connector). Re-seat each cable-end and finger-tighten connector retaining screws.
- Make sure that an active film score is playing and the center channel output of the Cinema Processor is functioning.
- If the sound is audible, but all attempts to get it louder fail, connect the DCM to a PC running DCM Manager software and check the Monitor Gain Levels settings on the Mute/Monitor tab. These settings have an attenuation range of 0 to -16 dB.

TROUBLESHOOTING

If some of the front panel LEDs don't illuminate....

- The DCM will only select and monitor amplifier channels that have been enabled using the DCM Manager program. The front panel LEDs and audio monitoring only allow use of channels set in the software. Connect the host PC to the DCM and run the DCM Manager program. Upload the current configuration and check the settings in the General tab/ Installed Outputs section. Make any required changes and download to the DCM. Save your file and verify proper front panel LED operation.

If no sound in the theater...

- Verify the Cinema Processor is providing active inputs to the DCM by monitoring the PROC inputs (see pages 11 and 12 if you are unsure of how to select audio to monitor).
 - If PROC inputs are active, then monitor the AMPS outputs (next step).
 - If PROC inputs are not active, check the cable between the DCM and the Cinema Processor or the Cinema Processor itself.
- Verify the amplifiers outputs by monitoring the AMPS outputs.
 - If no amplifier audio, check that the amplifiers are turned on and their gain controls are set to some useful level (not fully counter-clockwise or minimum).
 - Also check the DCM front panel LOAD FAULT LED; if it is illuminated, press the DIAGNOSTICS button and an LED will light above any channel indicator that has an open or shorted speaker cable. Use standard audio troubleshooting techniques to isolate which of the amplifier channels may have the fault.
 - If the LOAD FAULT LED is not illuminated, switch the BYPASS switch to the EMERGENCY position and verify center channel audio is present. If it is, you know that the cables, amplifier, and speaker for the center channel are okay. If you switch this back and still have no sound, check the DCM configuration file for proper signal routing using the DCM Manager software.

If one audio channel is missing ...

- Verify the amplifier for the respective channel is on and its gain controls set to a useful setting.
- Verify the DataPort cable for the respective amplifier is seated properly and secured to its respective connectors.
- Verify none of the channels are muted in the DCM Manager configuration. Connect with the DCM Manager software and upload the configuration to the host PC. See if the MUTE tab shows any channels muted; correct any settings as required. Check the configuration file for proper signal routing.

TROUBLESHOOTING

If theater audio is distorted ...

- Verify that the DCM **Input Clip** LED is not lit. If it is, the cinema processor output signal needs to be turned down.

- If any of the amplifier CLIP warning LEDs are illuminating, the output level of the DCM must be reduced or amplifier input sensitivity must be reduced.
 - DCM output level is adjusted using the DCM Manager software. Determine which channel's amplifier is clipping and make the necessary gain adjustments. This is done in the **DSP Settings** tab. These gain settings compensate for driver sensitivity differences, so all the high and low (or high, mid, low) gains should remain the same number of dB apart (compared to their factory setting). There is no surround channel gain adjustment in the DCM.
 - Amplifier input sensitivity adjustment: Refer to amplifier owner's manual.

If switching the **BYPASS** to **EMERGENCY** does not restore sound to the center channel...

- Verify the DCM is receiving input signals from the Cinema Processor.
- Verify connections from the Cinema Processor to the DCM.
- Verify connections from the DCM to the center channel amplifier.
- Verify the Cinema Processor and center channel amplifier are ON and functioning.
- Verify the center channel amplifier's Gain controls are set to a usable level.
- Verify center channel amplifier speaker connections and speaker condition.

NOTE: If the DCM unit is okay, place the **Bypass** switch back to the **NORMAL** position and the **Load Fault** indicator will light (after a few minutes) if there was an open- or short-circuit in the speaker cables.

NOTE: The Emergency Bypass circuitry in the DCM does not require power to operate. Even if the DCM loses power, signals can be bypassed to the center channel as long as the remaining required equipment is functioning properly.

If the DCM fails to turn on when the Power switch is set to the "on" position....

- Check the AC power cord and ensure both ends are fully inserted in their respective sockets.
- Check that the AC circuit being used is functioning. Test with a lamp or other known-good device.
- Verify the condition of the fuses. They are located in the rear panel IEC power connector. Pry the cover of the fuse holder, as shown, below. Inspect the fuses and replace if necessary.

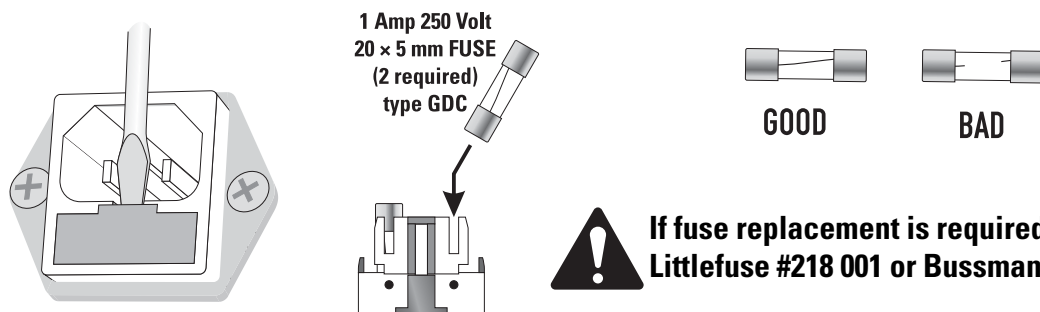

SPECIFICATIONS

DCM Inputs, Screen Channels and Subwoofer

Input Stage Type	Active balanced
Input Impedance	20k ohms
Maximum Input Level	+14.2 dBu (4.0 Vrms)
A-to-D Conversion	24-bit delta-sigma 128x oversampled (analog subwoofer on DCM-1)
Surround Channels	Hardwire pass-thru to DataPort Outputs (via Surround-EX insert)

DataPort Outputs

Screen Channels	
Output Adjustment	+6 to -18 dB in 0.1 dB steps
Dynamic Range	99 dB
THD+N at +12 dBu Input Level	0.02%, 20 hertz to 20 kilohertz, all filters flat
Frequency Response	20 hertz to 20 kilohertz
D-to-A Conversion	24-bit delta-sigma 128x oversampled
Filter Topology	24-bit digital IIR
Subwoofer	
Output Adjustment	+3 to -18 dB in 0.1 dB steps
Dynamic Range	99 dB
THD+N at +12 dBu Input Level	0.02%, 20 hertz to 20 kilohertz, all filters flat
Frequency Response	20 hertz to 20 kilohertz
Filter Topology	DCM-2 and DCM-3: 24-bit digital IIR DCM-1: digitally controlled analog
Surround Channels	Hardwire pass-thru from processor input (via Surround-EX insert)

Emergency Bypass Crossover

Filter Type	First-order Butterworth, 2- or 3-way
Attenuation Range (trim pot)	-6 to -24 dB

Subwoofer Output (screw terms.)

Output Stage Type	Single-ended balanced impedance
Output Impedance	50 ohms
Maximum Output Level	+14.2 dBu (4.0 Vrms)
Loading Requirements	$R_{min} = 2k$ ohms, $C_{max} = 4$ nanoFarads

SPECIFICATIONS

Hearing Impaired Output

Output Stage Type	Single-ended balanced impedance
Output Impedance	50 ohms
Nominal Output Level	-11.8 dBu (200 mVrms)
Loading Requirements	$R_{min} = 2k$ ohms, $C_{max} = 4$ nanoFarads

Monitor Speaker

Driver	4.5-inch full-range
Amplifier	10 watt class AB
Frequency Response	70 hertz to 15 kilohertz (± 2 dB)
Dynamic Processing	1.4:1 compression

Dimensions

19" (wide) x 5.25" (high) x 14" (deep)

Weight

17.3 pounds

Line Voltage

85 VAC - 260 VAC, 50/60 Hz

Fuse

Littlefuse #218 001 or Bussman #S5504-1A (250 Volt, 1 Amp)

Safety Agency Approvals

UL 6500, CSA

EMC Approvals

FCC Class A

Connectors

AC Power-	IEC style detachable cord receptacle
RS-232-	9-pin D-sub female receptacle
Cinema Processor Input-	25-pin D-sub female receptacle
DataPorts-	DCM-1 Eight 15-pin D-sub HD female receptacles
	DCM-2 Eleven 15-pin D-sub HD female receptacles
	DCM-3 Fifteen 15-pin D-sub HD female receptacles
Surround EX Insert-	9 pin D-sub male receptacle
Surround EX Switching-	screw terminal
Powered Subwoofer Out-	screw terminals
Hearing Impaired Out-	screw terminals

PC Communications

Baud rate 19,200bps

WARRANTY INFORMATION & HOW TO CONTACT QSC

WARRANTY (USA only; other countries, see your dealer or distributor)

Disclaimer

QSC Audio Products, Inc. is not liable for any damage to speakers, amplifiers, or any other equipment that is caused by negligence or improper installation and/or use of this cinema product.

Product Warranty

QSC Audio Products, Inc. ("QSC") guarantees its products to be free from defective material and / or workmanship for a period of three (3) years from date of sale, and will replace defective parts and repair malfunctioning products under this warranty when the defect occurs under normal installation and use - provided the unit is returned to our factory or one of our authorized service stations via pre-paid transportation with a copy of proof of purchase (i.e., sales receipt). This warranty provides that the examination of the return product must indicate, in our judgment, a manufacturing defect. This warranty does not extend to any product which has been subjected to misuse, neglect, accident, improper installation, or where the date code has been removed or defaced. QSC shall not be liable for incidental and/or consequential damages. This warranty gives you specific legal rights, and you may also have other rights which vary from state to state. This limited warranty is freely transferable during the term of the warranty period.

HOW TO CONTACT QSC AUDIO PRODUCTS



Mailing Address:

QSC Audio Products, Inc.
1675 MacArthur Boulevard
Costa Mesa, CA 92626-1468 USA



Telephone Numbers:

Main Number	(714) 754-6175
Sales	(714) 957-7100
Sales & Marketing	(800) 854-4079 <i>(toll-free in U.S.A. only)</i>
Technical Services Group	(714) 957-7150
	(800) 772-2834 <i>(toll-free in U.S.A. only)</i>



Facsimile Numbers:

Sales & Marketing FAX	(714) 754-6174
Technical Services Group FAX	(714) 754-6173



World Wide Web:

www.qscaudio.com

E-mail:

info@qscaudio.com
tech_support@qscaudio.com

This page intentionally left blank.



QSC Audio Products, Inc. 1675 MacArthur Boulevard Costa Mesa, California 92626 USA

"QSC" and the QSC logo are registered with the U.S. Patent and Trademark Office.

©2002 QSC Audio Products, Inc.