

PYLE[®] **PRO**



PEMP-6

6 Channel Stereo Console Mixer

OWNER'S MANUAL

Contents

User Guide	1
IMPORTANT SAFETY INSTRUCTIONS	4
SAFETY SYMBOL GUIDE	6
OVERVIEW	7
THE 60-SECOND GUIDE	7
INTRODUCTION	9
WIRING UP	10
BLOCK DIAGRAM	14
MONO INPUT CHANNEL	15
STEREO INPUT CHANNELS	18
MASTER SECTION	20
USING YOUR PEMP CONSOLE	22
FITTING OPTIONAL RACKMOUNT EARS	24
APPLICATIONS	25
GLOSSARY	28
TYPICAL CONNECTING LEADS	30
MARK-UP SHEETS	32
TYPICAL SPECIFICATIONS	34
	35

Polarity (Phase)

You will probably be familiar with the concept of polarity in electrical signals and this is of particular importance to balanced audio signals. Just as a balanced signal is highly effective at cancelling out unwanted interference, so two microphones picking up the same signal can cancel out, or cause serious degradation of the signal if one of the cables has the +ve and -ve wires reversed. This phase reversal can be a real problem when microphones are close together and you should therefore always take care to connect pins correctly when wiring audio cables.

Grounding and Shielding

For optimum performance use balanced connections where possible and ensure that all signals are referenced to a solid, noise-free earthing point and that all signal cables have their screens connected to ground. In some unusual circumstances, to avoid earth or ground 'loops' ensure that all cable screens and other signal earths are connected to ground only at their source and not at both ends.

If the use of unbalanced connections is unavoidable, you can minimise noise by following these wiring guidelines:

- On INPUTS, unbalance at the source and use a twin screened cable as though it were balanced.
- On OUTPUTS, connect the signal to the +ve output pin, and the ground of the output device to -ve. If a twin screened cable is used, connect the screen only at the mixer end.
- Avoid running audio cables or placing audio equipment close to thyristor dimmer units or power cables.
- Noise immunity is improved significantly by the use of low impedance sources, such as good quality professional microphones or the outputs from most modern audio equipment. Avoid cheaper high impedance microphones, which may suffer from interference over long cable runs, even with well-made cables.

Grounding and shielding is still seen as a black art, and the suggestions above are only guidelines. If your system still hums, an earth/ground loop is the most likely cause. Two examples of how an earth loop can occur are shown below.

Example 1

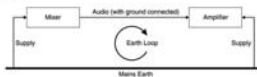

Example 2



Warning!



Under NO circumstances must the AC power mains earth be disconnected from the mains lead.

PROBLEM SOLVING

Basic problem solving is within the scope of any user if a few basic rules are followed.

- Get to know the Block Diagram of your console (see page 14).
- Get to know what all controls and/or connections in the system are supposed to do.
- Learn where to look for common trouble spots.

The Block Diagram is a representative sketch of all the components of the console, showing how they connect together and how the signal flows through the system. Once you have become familiar with the various component blocks you will find the Block Diagram is quite easy to follow and you will have gained a valuable understanding of the internal structure of the console.

Each component has a specific function and only by getting to know what each part is supposed to do will you be able to tell if there is a genuine fault! Many "faults" are the result of incorrect connection or control settings which may have been overlooked.

Basic Troubleshooting is a process of applying logical thought to the signal path through the console and tracking down the problem by elimination.

- Swap input connections to check that the source is really present. Check both Mic and Line Inputs.
- Eliminate sections of the channel by using the insert point to re-route the signal to other inputs that are known to be working.
- Route channels to different outputs or to auxiliary sends to identify problems on the Master section.
- Compare a suspect channel with an adjacent channel which has been set up identically. Use PFL to monitor the signal in each section.
- Insert-point contact problems may be checked by using an insert bypass jack with tip and ring shorted together as shown below. If the signal appears when the jack is inserted it shows that there is a problem with the normalising contacts on the jack socket, caused by wear or damage, or often just dirt or dust. Keep a few in your gig tool box.



Dummy Insert Bypass Jack

If in doubt please contact PYLE PRO customer support.

PRODUCTS UNDER WARRANTY

UK customers should contact their local dealer.

Customers outside the UK are requested to contact their territorial distributor who is able to offer support in the local time zone and language.

BLOCK DIAGRAM

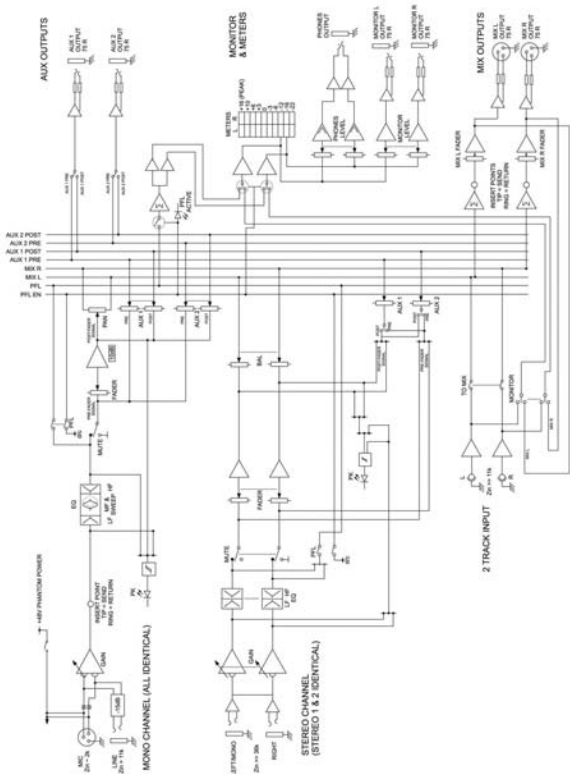

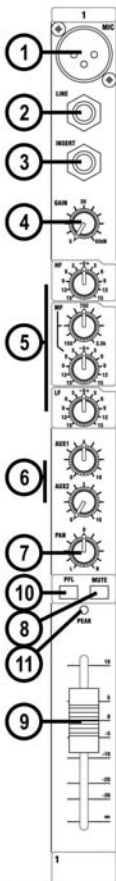

MONO INPUT CHANNEL

1 Mic Input

The MIC input accepts XLR-type connectors and is designed to suit a wide range of BALANCED or UNBALANCED signals. Professional dynamic, condenser or ribbon mics are best because these will be LOW IMPEDANCE. You can use low-cost HIGH IMPEDANCE mics, but the level of background noise will be higher. If you turn the PHANTOM POWER on (top right-hand side of the mixer) the socket provides a suitable powering voltage for professional condenser mics.



ONLY connect condenser microphones with the +48V powering OFF, and ONLY turn the +48V powering on or off with all output faders DOWN, to prevent damage to the mixer or external devices.

TAKE CARE when using unbalanced sources, which may be damaged by the phantom power voltage on pins 2 & 3 of the XLR connector.

Unplug any mics if you want to use the LINE Input. The input level is set using the GAIN knob.

2 Line Input

Accepts 3-pole 'A' gauge (TRS) jacks. Use this input for sources other than mics, such as keyboards, drum machines, synths, tape machines or DI'd guitars. The input is BALANCED for low noise and top quality from professional equipment, but you can use UNBALANCED sources by wiring up the jacks as shown below, although you should then keep cable lengths as short as possible. Unplug anything in the MIC input if you want to use this socket. Set the input level using the GAIN knob.

3 Insert Point

The unbalanced, pre-EQ insert point is a break in the channel signal path, allowing limiters, compressors, special EQ or other signal processing units to be added in the signal path. The Insert is a 3-pole 'A' gauge jack socket which is normally bypassed. When a jack is inserted, the signal path is broken, just before the EQ section.

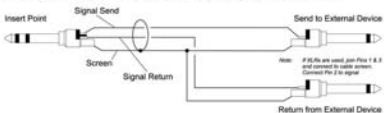

The Send may also be tapped off as an alternative pre-fade, pre-EQ direct output if required, using a lead with tip and ring shorted together so that the signal path is not interrupted (see below).



4 Gain

This knob sets how much of the source signal is sent to the rest of the mixer. Too high, and the signal will distort as it overloads the channel. Too low, and the level of any

background hiss will be more noticeable and you may not be able to get enough signal level to the output of the mixer.

Note that some sound equipment, particularly that intended for domestic use, operates at a lower level (-10dBV) than professional equipment and will therefore need a higher gain setting to give the same output level.

See "Initial Setup" on page 22 to learn how to set GAIN correctly.

5 Equaliser

The Equaliser (EQ) allows fine manipulation of the sound, particularly to improve the sound in live PA applications where the original signal is often far from ideal and where slight boosting or cutting of particular voice frequencies can really make a difference to clarity. There are three sections giving the sort of control usually only found on much larger mixers. The EQ knobs can have a dramatic effect, so use them sparingly and listen carefully as you change any settings so that you get to know how they affect the sound.

HF EQ

Turn to the right to boost high (treble) frequencies above 12kHz by up to 15dB, adding crispness to cymbals, vocals and electronic instruments. Turn to the left to cut by up to 15dB, reducing hiss or excessive sibilance which can occur with certain types of microphone. Set the knob in the centre-detented position when not required.

MID EQ

There are two knobs which work together to form a SWEPT MID EQ. The lower knob provides 15dB of boost and cut, just like the HF EQ knob, but the frequency at which this occurs can be set by the upper knob over a range of 140Hz to 3kHz. This allows some truly creative improvement of the signal in live situations, because this mid band covers the range of most vocals. Listen carefully as you use these controls together to find how particular characteristics of a vocal signal can be enhanced or reduced. Set the lower knob to the centre-detented position when not required.

LF EQ

Turn to the right to boost low (bass) frequencies below 60Hz by up to 15dB, adding warmth to vocals or extra punch to synths, guitars and drums. Turn to the left to cut low frequencies by up to 15dB for reducing hum, stage rumble or to improve a mushy sound. Set the knob to the centre-detented position when not required.

6 Aux Sends

These are used to set up separate mixes for FOLDBACK, EFFECTS or recording, and the combination of each Aux Send is mixed to the respective Aux Output. For Effects it is useful for the signal to fade up and down with the fader (this is called POST-FADE), but for Foldback or Monitor feeds it is important for the send to be independent of the fader (this is called PRE-FADE).

AUX SENDS 1 and 2 are both globally switchable between pre and post-fade (see master section on page 20/21).

7 PAN

This control sets the amount of the channel signal feeding the Left and Right MIX buses, allowing you to move the source smoothly across the stereo image. When the control is turned fully left or right you are able to route the signal at unity gain to either left or right outputs individually.

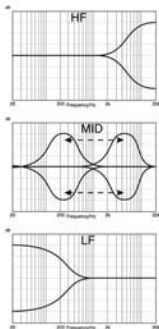

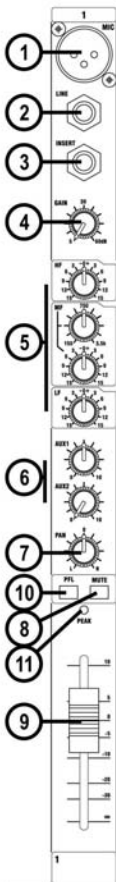

8 MUTE

All outputs from the channel except inserts are on when the MUTE switch is released and muted when the switch is down, allowing levels to be pre-set before the signal is required.

9 INPUT CHANNEL FADER

The 60mm FADER, with a custom-designed law to give even smoother control of the overall signal level in the channel strip, allows precise balancing of the various source signals being mixed to the Master Section. You get most control when the input GAIN is set up correctly, giving full travel on the fader. See the "Initial Setup" section on page 22 for help in setting a suitable signal level.

10 PFL

When the latching PFL switch is pressed, the pre-fade pre-mute signal is fed to the headphones, control room output and meters, where it replaces the MIX. The PFL ACTIVE LED on the Master section illuminates to warn that a PFL is active. This is a useful way of listening to any required input signal without interrupting the main mix, for making adjustments or tracing problems. When PFL is pressed anywhere on the console, the Control Room outputs automatically switch from monitoring the Mix Outputs.

11 PEAK LED

This LED will light when the signal level approaches clipping at any of the three monitored points:

- a) PRE-EQ
- b) POST-EQ
- c) POST-FADE

STEREO INPUT CHANNELS

1 INPUTS STEREO 1/2

These inputs accept 3-pole 'A' gauge (TRS) jacks. Use these inputs for sources such as keyboards, drum machines, synths, tape machines or processing units. The inputs are **BALANCED** for low noise and top quality from professional equipment, but you can use **UNBALANCED** sources by wiring up the jacks as shown in the "Wiring it Up" section earlier in this manual, although you should then keep cable lengths as short as possible. Mono sources may be used by plugging into the left jack only.

2 GAIN

The **GAIN** control sets the level of the channel signal.

3 EQUALISER

HF EQ

Turn to the right to boost high (treble) frequencies, adding crispness to percussion from drum machines, synths and electronic instruments. Turn to the left to cut these frequencies, reducing hiss or excessive brilliance. Set the knob in the centre-detented position when not required. The control has a shelving response giving 15dB of boost or cut at 12kHz.

LF EQ

Turn to the right to boost low (bass) frequencies, adding extra punch to synths, guitars and drums. Turn to the left to reduce hum, boominess or improve a mushy sound. Set the knob to the centre-detented position when not required. The control has a shelving response giving 15dB of boost or cut at 60Hz.

4 AUX SENDS

These are used to set up a separate mixes for **FOLDBACK**, **EFFECTS** or recording, and the combination of each Aux Send is mixed to the respective Aux Output at the rear of the mixer. For Effects it is useful for the signal to fade up and down with the fader (this is called **POST-FADE**), but for Foldback or Monitor feeds it is important for the send to be independent of the fader (this is called **PRE-FADE**).

AUX SENDS 1 and 2 are both globally switchable between pre and post-fade (see master section on page 20/21). The send pots are fed with a mono sum of the L & R signals.

5 BALANCE

This control sets the amount of the channel signal feeding the Left and Right MIX buses, allowing you to balance the source in the stereo image. When the control is turned fully right or left you feed only that side of the signal to the mix. Unity gain is provided by the control in the centre-detented position.

6 MUTE

All outputs from the channel are enabled when the **MUTE** switch is released and muted when the switch is down.

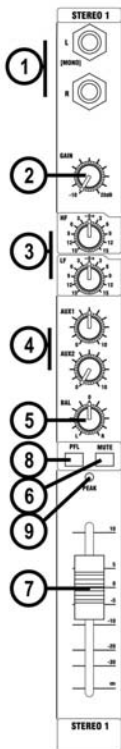

7 FADER

The 60mm FADER gives you smooth control of the overall signal level in the channel strip, allowing precise balancing of the various source signals being mixed to the Master Section. It is important that the input level is set correctly to give maximum travel on the fader which should normally be used at around the "0" mark. See the "Initial Setup" section on page 22 for help in setting the right level.

8 PFL

When the latching PFL switch is pressed, the pre-fade pre-mute signal is fed in mono to the headphones, control room output and meters, where it replaces the MIX. The PFL ACTIVE LED on the Master section illuminates to warn that a PFL is active. The Left and Right meters display the PFL signal in mono. This is a useful way of listening to any required input signal without interrupting the main mix, for making adjustments or tracing problems.

9 CHANNEL PEAK LED

This LED will light when the signal level approaches clipping at any of the three monitored points:

- PRE-EQ
- POST-EQ
- POST-FADE

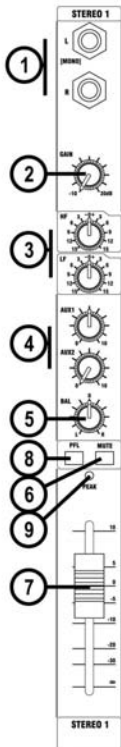

MASTER SECTION

1 PHANTOM POWER

Many professional condenser mics need PHANTOM POWER, which is a method of sending a powering voltage down the same wires as the mic signal. Press the switch to enable the +48V power to all of the MIC inputs. The adjacent LED illuminates when the power is active.



WARNING: TAKE CARE when using unbalanced mics which may be damaged by the phantom power voltage. Balanced dynamic mics can normally be used with phantom power switched on (contact your microphone manufacturer for guidance).

Mics should always be plugged in, and all output faders set to minimum before switching the Phantom Power ON to avoid damage to external equipment

2 POWER INDICATOR

This LED lights to show when power is connected to the console.

3 MASTER FADERS

The MASTER FADERS set the final level of the MIX outputs, and separate faders are provided for each output. These should normally be set close to the '0' mark if the input GAIN settings have been correctly set, to give maximum travel on the faders for smoothest control.

4 MIX OUTPUTS & INSERTS

The Mix LEFT and RIGHT outputs are sent from the XLR sockets as balanced signals. The Mix INSERT points are on 3-pole 'A' gauge jacks and are unbalanced.

5 BARGRAPH METERS

The three-colour peak reading BARGRAPH METERS normally show the level of the MIX RIGHT and MIX LEFT outputs, giving you a constant warning of excessive peaks in the signal which might cause overloading. Aim to keep the signal within the amber segments at peak levels for best performance.

Similarly, if the output level is too low and hardly registering at all on the meters, the level of background noise may become significant. Take care to set up the input levels for best performance.

When any PFL switch is pressed, the meters switch to show the selected PFL signal on both meters, in mono; the PFL ACTIVE LED also lights.

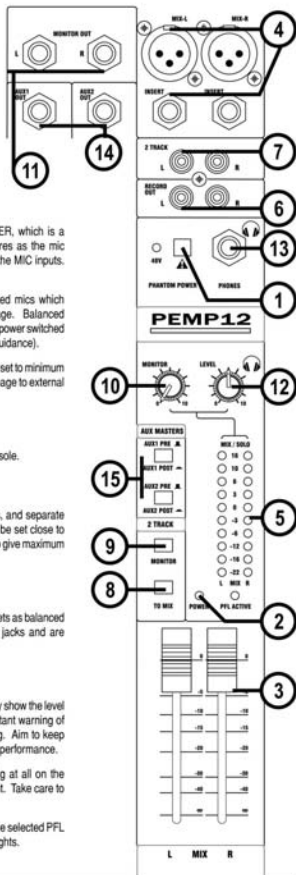

6 RECORD OUTPUTS

These two RCA outputs carry a copy of the MIX L and MIX R signals. They allow the use of a recording device, e.g. DAT player, Minidisc, Cassette tape recorder etc.

7 2 TRACK

These two RCA phono sockets are unbalanced Left and Right line-level inputs, used for connecting a playback device.

8 2 TRACK TO MIX

Press this switch to route the 2 Track signals, connected to the Left and Right RCA sockets 7, to the MIX Left/Right signal at the MIX outputs.

9 MONITOR 2 TRACK

Press this switch to route the 2 Track signal to the monitor and phones, over-riding the default Monitor/Phones signal.

10 MONITOR LEVEL

This control sets the level to the MONITOR LEFT & RIGHT outputs. If headphones are plugged into the PHONES jack, the headphone level will track the Monitor Level.

11 MONITOR OUTPUTS

The Monitor Outputs are on 3-pole 'A' gauge jacks and are balanced connections

12 PHONES LEVEL

This control sets the output level to the Headphone outputs. If headphones are plugged into the PHONES jack, then the knob sets a comfortable headphone listening level without affecting the Monitor output levels.

13 HEADPHONES JACK

The PHONES output is a 3-pole 'A' gauge jack, wired as a stereo output as shown, ideally for headphones of 200 Ω or greater. 8 Ω headphones are not recommended.

14 AUX OUTPUTS (1 & 2)

These outputs are on 3-pole 'A' gauge jacks and are balanced outputs.

15 AUX PRE/POST SWITCHES

These two switches globally switch the AUX 1 and AUX 2 feeds, respectively, on all the input modules to be either pre-fade or post-fade.

IMPORTANT SAFETY INSTRUCTIONS

Read these instructions.

Keep these instructions.

Heed all warnings.

Follow all instructions.

Do not use this apparatus near water.

Clean only with a dry cloth.

Do not block any ventilation openings. Install in accordance with the manufacturer's instructions.

Do not install near any heat sources such as radiators, heat registers, stoves, or other apparatus (including amplifiers) that produce heat.

Do not defeat the safety purpose of a polarised or grounding type plug. A polarised plug has two blades with one wider than the other. A grounding type plug has two blades and a third grounding prong. The wide blade or the third prong are provided for your safety. If the provided plug does not fit into your outlet, consult an electrician for replacement of the obsolete outlet.

Protect the power cord from being walked on or pinched particularly at plugs, convenience receptacles and the point where they exit from the apparatus.

Only use attachments/accessories specified by the manufacturer.



Use only with the cart, stand, tripod, bracket or table specified by the manufacturer, or sold with the apparatus. When a cart is used, use caution when moving the cart/apparatus combination to avoid injury from tip-over.

Unplug this apparatus during lightning storms or when unused for long periods of time.

Refer all servicing to qualified service personnel. Servicing is required when the apparatus has been damaged in any way, such as power-supply cord or plug is damaged, liquid has been spilled or objects fallen into the apparatus, the apparatus has been exposed to rain or moisture, does not operate normally, or has been dropped.

USING YOUR PEMP CONSOLE

The final output from your sound system can only ever be as good as the weakest link in the chain, and especially important is the quality of the source signal because this is the starting point of the chain. Just as you need to become familiar with the control functions of your mixer, so you must recognise the importance of correct choice of inputs, microphone placement and input channel settings. However, no amount of careful setting up can take account of the spontaneity and unpredictability of live performance. The mixer must be set up to provide 'spare' control range to compensate for changing microphone position and the absorption effect of a large audience (different acoustic characteristics from soundcheck to show).

MICROPHONE PLACEMENT

Careful microphone placement and the choice of a suitable type of microphone for the job is one of the essentials of successful sound reinforcement. The diagrams on the left show the different pick-up patterns for the most common types of microphone. Cardioid microphones are most sensitive to sound coming from in front, and hypercardioid microphones offer even greater directivity, with a small amount of pickup behind the microphone. These types are ideal for recording vocalists or instruments, where rejection of unwanted sounds and elimination of feedback is important. The aim should be to place the microphone as close as physically possible to the source, to cut out unwanted surrounding sounds, allow a lower gain setting on the mixer and avoid feedback. Also a well chosen and well placed microphone should not need any appreciable equalisation.

There are no exact rules - let your ears be the judge. In the end, the position that gives the desired effect is the correct position!

INITIAL SETUP

Once you have connected up your system (see the sections on connection and wiring earlier in this manual for guidance) you are ready to set initial positions for the controls on your mixer.

Set up individual input channel as follows:

- Connect your sources (microphone, keyboard etc.) to the required inputs.



WARNING: Phantom powered mics should be connected before the +48V is switched on. Ensure the PA system is OFF when switching phantom power on or off.

- Set Master faders at 0, input faders at 0, and set power amplifier levels to about 70%.
- Provide a typical performance level signal and press the PFL button on the first channel, monitoring the level on the bargraph meters.
- Adjust the input gain until the meter display is in the amber section, with occasional peaks to the first red LED at a typical maximum source level. This allows sufficient headroom to accommodate peaks and establishes the maximum level for normal operation (but see note below).
- Repeat this procedure on other channels as required. As more channels are added to the mix, the meters may move into the red section. Adjust the overall level using the Master Faders if necessary.
- Listen carefully for the characteristic sound of 'feedback'. If you cannot achieve satisfactory input level setting without feedback, check microphone and speaker placement and repeat the exercise. If feedback persists, it may be necessary to use a Graphic Equaliser to reduce the system response at particular resonant frequencies.



Cardioid Response



Hypercardioid Response



Omnidirectional Response

**Note:**

The initial settings should only be regarded as a starting point for your mix. It is important to remember that many factors affect the sound during a live performance, for instance the size of the audience!

You are now ready to start building the mix and this should be done progressively, listening carefully for each component in the mix and watching the meters for any hint of overload. If this occurs, back off the appropriate Channel Fader slightly until the level is out of the red segments, or adjust the Master Faders.

Remember that the mixer is a mixer, not an amplifier. Increasing the overall level is the job of the amplifier, and if it is impossible to provide adequate level, it is probable that the amplifier is too small for the application. Choose your amplifier carefully, and do not try to compensate for lack of power by using the mixer to increase output level.

**Note:**

The level of any source signal in the final output is affected by many factors, principally the Input Gain control, Channel Fader and Mix Faders. You should try to use only as much microphone gain as required to achieve a good balance between signals, with the faders set as described above.

If the input gain is set too high, the channel fader will need to be pulled down too far in compensation to leave enough travel for successful mixing and there is a greater risk of feedback because small fader movements will have a very significant effect on output level. Also there will be a chance of distortion as the signal overloads the channel and causes clipping.

If the gain is set too low, you will not find enough gain on the faders to bring the signal up to an adequate level, and background hiss will be more noticeable.

This is illustrated below:

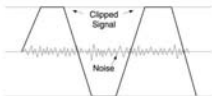

If the signal level is too high, clipping distortion may occur.



If the signal level is too low it may be masked by the noise.

FITTING OPTIONAL RACKMOUNT EARS

Attach rack ears to sides of mixer at points **A** with the screws provided

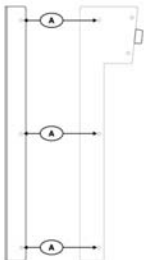
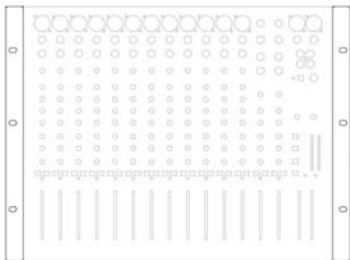

Note: a rack extender is included in the PEMP6 and PEMP8 rack mounting kits to make the console fit into a 19" frame.

The part numbers for the kits are:

RW5744 RACK MOUNTING KIT - PEMP6

RW5745 RACK MOUNTING KIT - PEMP8

RW5746 RACK MOUNTING KIT - PEMP12

APPLICATIONS

APPLICATION 1 - LIVE SOUND REINFORCEMENT

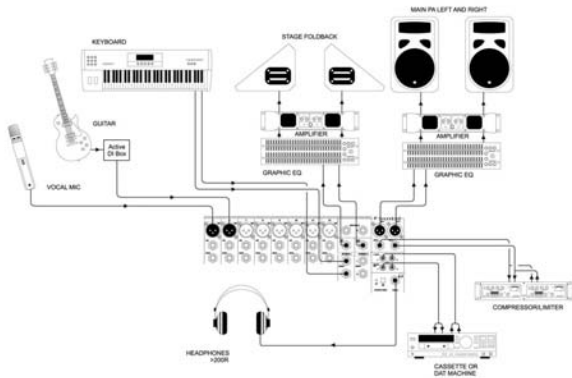

APPLICATION 2 - MULTISPEAKER APPLICATIONS

This configuration demonstrates how multiple speaker configurations can be driven by the PEMP.

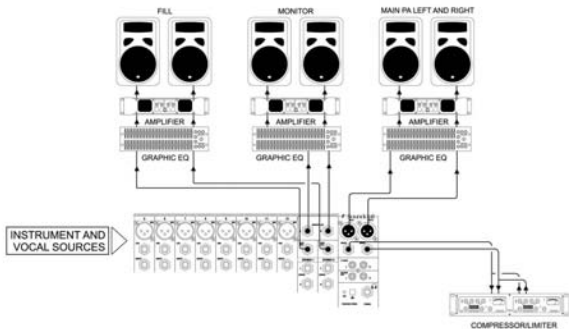

APPLICATION 3 - PLACES OF WORSHIP

This configuration uses the Aux 2 output to drive an induction loop for the hard of hearing. Aux 1 output is used to generate foldback monitoring for the speaker/singer. The main outputs are used to drive the main speaker system. The record and playback connections are used to pass audio to and from a DAT machine or CDR.

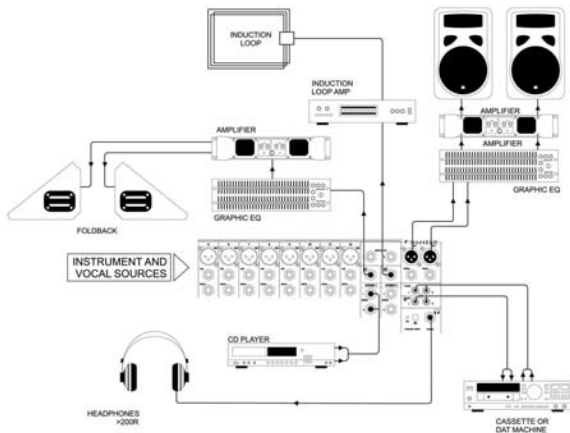

APPLICATION 4 - RECORDING

The insert points on channels 1-8 may be used to feed a multitrack recorder as shown (link the send and return signals). The Mix outputs are used for a preliminary stereo mix on a DAT recorder.

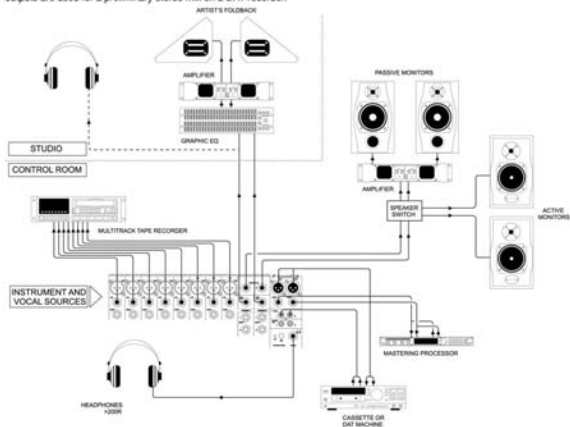

APPLICATION 5 - LINKING TWO PEMP CONSOLES

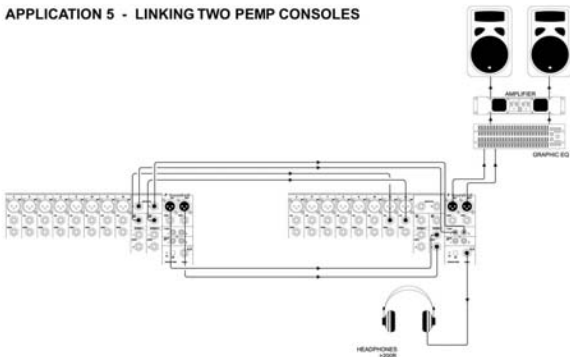

GLOSSARY

Auxiliary send	An output from the console comprising a mix of signals from channels derived independently of the main stereo mix.
Balance	The relative levels of the left and right channels of a stereo signal.
Balanced	A method of audio connection which 'balances' the wanted signal between two wires, these wires also have a screen which carries no signal. Any interference is picked up equally by the two wires, which results in cancellation of the unwanted signal. In this guide, the term can refer to various circuit architectures. Connection details are given in relevant sections.
Clipping	The onset of severe distortion in the signal path, usually caused by the peak signal voltage being limited by the circuit's power supply voltage.
DAT	Digital Audio Tape, a cassette-based digital recording format.
dB (decibel)	A ratio of two voltages or signal levels, expressed by the equation $dB=20\log_{10}(V1/V2)$. Adding the suffix 'u' denotes the ratio is relative to 0.775V RMS.
DI(direct injection)/DI Box	The practice of connecting an electric musical instrument directly to the input of the mixing console, rather than to an amplifier and loudspeaker which is covered by a microphone feeding the console.
Equaliser	A device that allows the boosting or cutting of selected bands of frequencies in the signal path.
Fader	A linear control providing level adjustment.
Feedback	The 'howling' sound caused by bringing a microphone too close to a loudspeaker driven from its amplified signal.
Foldback	A feed sent back to the artistes via loudspeakers or headphones to enable them to monitor the sounds they are producing.
Frequency response	The variation in gain of a device with frequency.
Gain	The amount of amplification in level of the signal.
Headroom	The available signal range above the nominal level before clipping occurs.
Impedance balancing	A technique used on unbalanced outputs to minimise the effect of hum and interference when connecting to external balanced inputs.
Insert	A break point in the signal path to allow the connection of external devices, for instance signal processors or other mixers at line level signals. Nominal levels can be anywhere between -0dBu to +6dBu, usually coming from a low impedance source.
Pan (pot)	Abbreviation of 'panorama'; controls the levels sent to left and right outputs.
Peaking	The point at which a signal rises to its maximum instantaneous level, before falling back down again. It can also describe an equaliser response curve affecting only a band of frequencies, (like on a graphic equaliser), "peaking" at the centre of that band.
Peak LED	A visual indication of the signal peaking just before the onset of clipping, which will distort the signal.
PFL	Pre-fade listen; a function that allows the operator to monitor the pre-fade signal in a channel independently of the main mix.
Phase	A term used to describe the relationship of two audio signals. In-phase signals reinforce each other, out-of-phase signals result in cancellation. Phase is a measurement of relative displacement between two waves of identical frequency.
Polarity	A term used to describe the orientation of the positive and negative poles of an audio connection. Normally connections are made with positive to positive, negative to negative. If this is reversed, the result will be out-of-phase signals (see 'phase' above).
Post-fade	The point in the signal path after a fader and therefore affected by the fader position.

Pre-fade	The point in the signal path before a fader, and therefore unaffected by the fader position.
Rolloff	A fall in gain at the extremes of the frequency response.
Shelving	An equaliser response affecting all frequencies above or below the break frequency i.e. a highpass or lowpass derived response.
Spill	Acoustic interference from other sources.
Transient	A momentary rise in the signal level.
Unbalanced	A method of audio connection which uses a single wire and the cable screen as the signal return. This method does not provide the noise immunity of a balanced input (see above).
+48V	The phantom power supply, available at the channel mic inputs, for condenser microphones and active DI boxes.

TYPICAL CONNECTING LEADS

Audio connectors used with Soundcraft consoles



Balanced - Line Inputs, Mix L & R Outputs, Stereo Inputs, Auxiliary Outputs

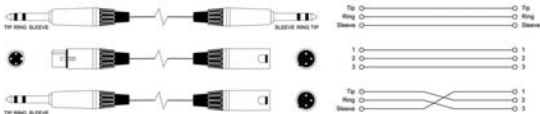

Unbalanced - Direct Output, Monitor Output, Stereo Return Inputs

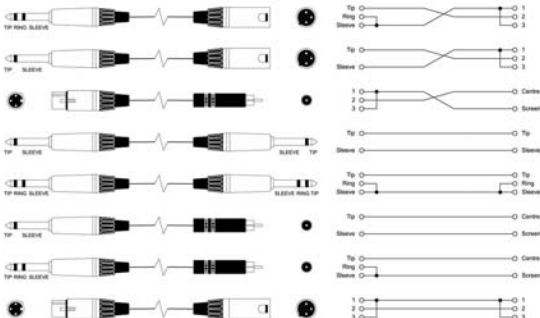

Insert Cables - Mono Inserts

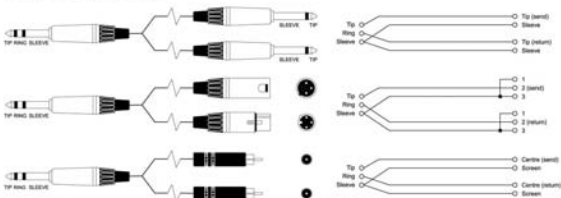

'Y' Cables (Balanced) Where used ... Aux. Mix outputs

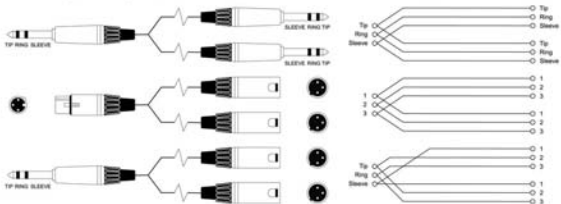

Headphone Separator Note: for every doubling of headphones the load impedance is halved. Do not go below 200R.

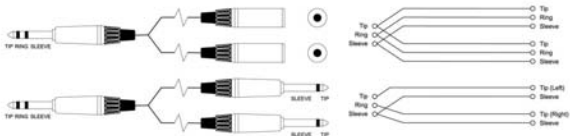

'Y' Cables (Unbalanced)

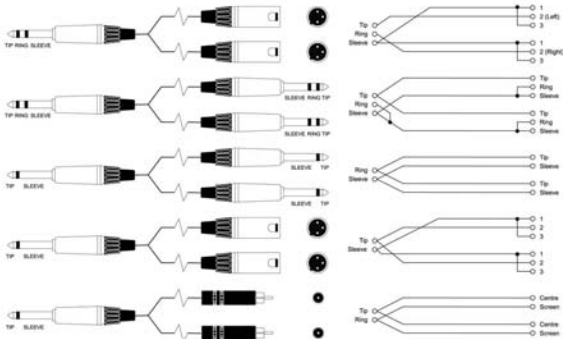

Note: It is recommended that all maintenance and service on the product should be carried out by PYLE PRO. PYLE PRO cannot accept any liability whatsoever for any loss or damage caused by service, maintenance or repair by unauthorised personnel.

WARNING: To reduce the risk of fire or electric shock, do not expose this apparatus to rain or moisture.

Do not expose the apparatus to dripping or splashing and do not place objects filled with liquids, such as vases, on the apparatus.

No naked flame sources, such as lighted candles, should be placed on the apparatus.

Ventilation should not be impeded by covering the ventilation openings with items such as newspapers, table cloths, curtains etc.

THIS APPARATUS MUST BE EARTHED. Under no circumstances should the safety earth be disconnected from the mains lead.

The mains supply disconnect device is the mains plug. It must remain accessible so as to be readily operable when the apparatus is in use.

If any part of the mains cord set is damaged, the complete cord set should be replaced. The following information is for reference only.

The wires in the mains lead are coloured in accordance with the following code:

Earth (Ground):	Green and Yellow (US - Green/Yellow)
Neutral:	Blue (US - White)
Live (Hot):	Brown (US - Black)

As the colours of the wires in the mains lead may not correspond with the coloured markings identifying the terminals in your plug, proceed as follows:

The wire which is coloured Green and Yellow must be connected to the terminal in the plug which is marked with the letter E or by the earth symbol. 

The wire which is coloured Blue must be connected to the terminal in the plug which is marked with the letter N

The wire which is coloured Brown must be connected to the terminal in the plug which is marked with the letter L

Ensure that these colour codes are followed carefully in the event of the plug being changed

This unit is capable of operating over a range of mains voltages as marked on the rear panel.

MARK-UP SHEETS

You may freely copy these pages, and use them to record the settings used for particular applications/gigs.

1 2 3 4 5 6						7 8	
MIC	MIC	MIC	MIC	MIC	MIC	MIC	MIC
LINE	LINE	LINE	LINE	LINE	LINE	LINE	LINE
INSERT	INSERT	INSERT	INSERT	INSERT	INSERT	INSERT	INSERT
GAIN	GAIN	GAIN	GAIN	GAIN	GAIN	GAIN	GAIN
EQ	EQ	EQ	EQ	EQ	EQ	EQ	EQ
EQ	EQ	EQ	EQ	EQ	EQ	EQ	EQ
EQ	EQ	EQ	EQ	EQ	EQ	EQ	EQ
AD1	AD1	AD1	AD1	AD1	AD1	AD1	AD1
AD2	AD2	AD2	AD2	AD2	AD2	AD2	AD2
PWR	PWR	PWR	PWR	PWR	PWR	PWR	PWR
<input type="checkbox"/> PFL	<input type="checkbox"/> MUTE	<input type="checkbox"/> PFL	<input type="checkbox"/> MUTE	<input type="checkbox"/> PFL	<input type="checkbox"/> MUTE	<input type="checkbox"/> PFL	<input type="checkbox"/> MUTE
<input type="checkbox"/>	<input type="checkbox"/>	<input type="checkbox"/>	<input type="checkbox"/>	<input type="checkbox"/>	<input type="checkbox"/>	<input type="checkbox"/>	<input type="checkbox"/>
PEAK	PEAK	PEAK	PEAK	PEAK	PEAK	PEAK	PEAK
1	2	3	4	5	6	7	8

TYPICAL SPECIFICATIONS

Noise (22Hz-22kHz measurement bandwidth)	
Mic EIN @ max gain, 150 ohms source impedance	-128dBu
Mix @max, faders down	<-85dBu
Crosstalk (typ. @ 1kHz)	
Channel mute	>96dB
Fader cut-off (rel +10 mark)	>96dB
Aux send pot offness	>86dB
Frequency response	
Mic/Line input to any output	+/- 0.5dB 20Hz - 20kHz
THD+Noise	
Mic gain 30dB, -30dBu input	
Mix out, fader max @ 1kHz	<0.007 %
Input & output Impedances	
Mic input	2.4k Ω
Line input	11k Ω
Stereo input	100k Ω
Outputs	75 Ω
Input & output levels	
Mic input max level	+17dBu
Line input max level	+30dBu
Stereo input max level	+30dBu
Mix output max level	+20dBu
Headphones (@ 200 Ω)	300mW
EQ	
EQ Bands (Mono input) +/- 15dB	
Lo	80Hz
Mid (swept)	140Hz - 3kHz
Hi	12kHz
Q	1.5
EQ Bands (stereo input) +/- 15dB	
Lo	80Hz
Hi	12kHz
AVERAGE POWER CONSUMPTION (QUIESCENT)	
PEMP6	13 Watts
PEMP8	14.5 Watts
PEMP12	17 Watts
MIN / MAX OPERATING TEMPERATURE	
Centigrade / Fahrenheit	0°C - 50°C / 32°F - 122°F

For your own safety and to avoid invalidation of the warranty please read this section carefully.

SAFETY SYMBOL GUIDE

For your own safety and to avoid invalidation of the warranty all text marked with these symbols should be read carefully.



WARNINGS

The lightning flash with arrowhead symbol, is intended to alert the user to the presence of un-insulated "dangerous voltage" within the product's enclosure that may be of sufficient magnitude to constitute a risk of electric shock to persons.



CAUTIONS

The exclamation point within an equilateral triangle is intended to alert the user to the presence of important operating and maintenance (servicing) instructions in the literature accompanying the appliance.



NOTES

Contain important information and useful tips on the operation of your equipment.



HEADPHONES SAFETY WARNING

Contain important information and useful tips on headphone outputs and monitoring levels.

Recommended Headphone Impedance \geq 200 Ohms.

OVERVIEW

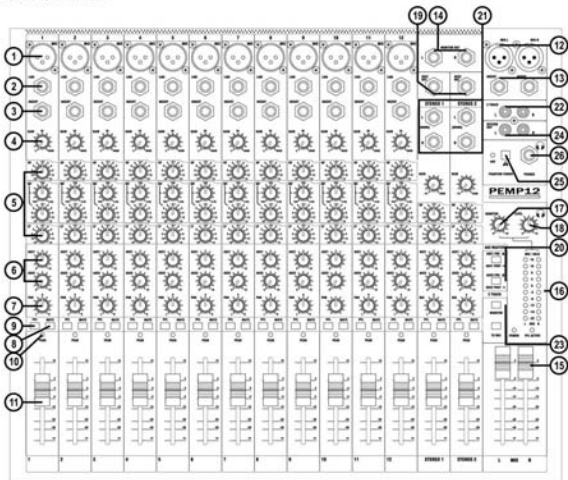

THE 60-SECOND GUIDE

To get you working as fast as possible, this manual begins with a 60-second guide. Here you can find quick information on any feature of the console.

1 MIC INPUT (XLR)

Connect Microphones here. If you are using a condenser mic, ensure phantom power is supplied by pressing the switch at the top of the master section.



WARNING: Do Not apply Phantom Power before connecting a microphone.

2 LINE INPUT (1/4" Jack)

Connect Line level sources here, e.g. Synth, Drum Machine, DI etc.

3 INSERT POINT (1/4" Jack)

Connect Signal processors here, e.g. Compressor, Gate etc.

4 GAIN CONTROL

Adjust this to increase or decrease the level of the incoming signal.

5 EQ STAGE

Adjust these controls to change the signal tone (the character of the signal).

6 AUX SENDS

Adjust these controls to change the level of the signal to an FX unit or an artist's monitors (headphones/in-ear/stage monitors). Aux 1&2 are switchable pre/post fade.

7 PAN CONTROL

Use this control to position the signal within the stereo field.

8 MUTE SWITCH

When this is pressed you will hear no signal from the channel (post-mute signals).

9 PFL

When pressed the signal will appear on the monitor and headphone outputs - use this to monitor the post-EQ signal from the channel.

- 10 PEAK LED** This is used to indicate that the signal is close to distorting (clipping) on a specific channel.
- 11 INPUT CHANNEL FADER** This is used to control the level fed to the Mix Bus and post-fade sends.
- 12 MIX OUTPUTS (XLR)** Connect these to your analogue recording device, or to your amplification system.
- 13 MIX INSERTS (¼" Jack)** This is a pre-fade break in the signal path which can be used to feed a dynamics or mastering device. The signal is sent from the tip of the jack plug and the return path comes back in on the ring of the jack plug.
- 14 MONITOR O/Ps (¼" Jack)** These are used to feed your monitoring system. This can be directly connected to powered monitors, or indirectly via an amplifier to standard monitors.
- 15 MASTER FADERS** These faders control the overall level of the mix outputs.
- 16 MAIN METERS** These show the level of the mix outputs. When the PFL ACTIVE LED is lit, the meters show the level of the selected PFL signal.
- 17 MONITOR CONTROL** This controls the level of the signal sent to your monitoring system.
- 18 PHONES CONTROL** This controls the level of the signal sent to the headphones jack socket.
- 19 AUX OUTPUTS (¼" Jack)** These two outputs can be used to send the channel signal to an FX unit or an artist's monitors (headphones/in-ear/stage monitors). Aux 1&2 are switchable pre/post fade.
- 20 AUX CONTROLS** These two switches globally switch the AUX1 and AUX2 feeds respectively, on all the input modules to be either pre or post-fade.
- 21 STEREO INPUTS (¼" Jack)** These two inputs can be used to connect line level stereo inputs from keyboards, sound modules, samplers, computer based audio cards etc. These inputs pass through a normal channel strip, with EQ, Auxes and a Balance control.
- 22 2-TRACK INPUTS (RCA Phono)** Here you can connect the playback from your recording device.
- 23 2-TRACK CONTROLS** Use these to control the 2 Track signal. The MONITOR switch sends the signal to the monitor outputs and phones, whilst the TO MIX switch sends it to the main mix.
- 24 RECORD OUTPUTS (RCA Phono)** Here you can connect the input to your recording device.
- 25 PHANTOM POWER**  Press this to switch the phantom power (48V) on for condenser microphones.
- 26 HEADPHONES (¼" Jack)** Plug your headphones into this socket. Recommended headphones impedance is 200 ohms or greater.
- WARNING:** Do Not apply Phantom Power before connecting a microphone.

INTRODUCTION

Thank you for purchasing a PYLE PRO PEMP mixer. The PEMP range is our most cost-effective mixing solution, bringing you all the features and performance that you expect from a PYLE PRO product, at an extraordinarily low price.

The packaging, which your PEMP arrived in, forms part of the product and must be retained for future use.

Owning a RYLE PRO console brings you the expertise and support of one of the industry's leading manufacturers, and the results of nearly 3 decades of supporting some of the biggest names in the business. Our knowledge has been attained through working in close contact with leading professionals and institutes to bring you products designed to get the best possible results from your mixing.

Built to the highest standards using quality components and surface mount technology, the PEMP is designed to be as easy to use as possible. We have spent years researching the most efficient methods of control for two key reasons:

1) Engineers, musicians, writers and programmers all need to have very few interruptions to the creative process; our products have been designed to be almost transparent, allowing this process to breathe.

2) Whether performing or recording, time is a very expensive and rare commodity. Our products have a user interface which is recognised by millions to be the industry standard because of its efficiency.

The sonic qualities of our products are exemplary - some of the same circuits which are used on our most expensive consoles are employed in the PEMP, bringing you the great PYLE PRO quality in a small format console without compromise.

You will also be glad to know you have a one year warranty with your product from the date of purchase. The PEMP has been designed using the latest high-end software based engineering packages. Every console from PYLE PRO has been proven to stand up to all the stress and rigours of modern day mixing environments.

The entire PEMP is manufactured using some of the most advanced techniques in the world, from high density surface mount PCB technology, to computer aided test equipment able to measure signals well outside the range of normal hearing. As each console passes through to be quality checked before packing, there is also a human listening station. Something we have learnt over the years is that the human touch counts - and only by using people can you ensure the product meets the high demands of the user.

ADVICE FOR THOSE WHO PUSH THE BOUNDARIES



Although your new console will not output any sound until you feed it signals, it has the capability to produce sounds which when monitored through an amplifier or headphones can damage hearing over time.

Please take care when working with your audio - if you are manipulating controls which you don't understand (which we all do when we are learning), make sure your monitors are turned down. Remember that your ears are the most important tool of your trade, look after them, and they will look after you.

Most importantly - don't be afraid to experiment to find out how each parameter affects the sound - this will extend your creativity and help you to get the best from your mixer and the most respect from your artists and audience.

WIRING UP

Please refer to pages 30/31 for additional wiring details.



Balanced Mic XLR

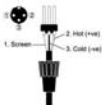

Unbalanced Mic XLR

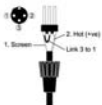

3 pole jack 2 pole jack
Balanced Unbalanced

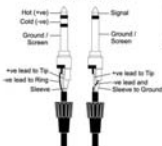

Inserts

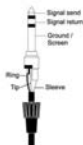

Mic Input

The MIC input accepts XLR-type connectors and is designed to suit a wide range of BALANCED or UNBALANCED low-level signals, whether from delicate vocals requiring the best low-noise performance, or drum kits needing maximum headroom. Professional dynamic, condenser or ribbon mics are best because these will be LOW IMPEDANCE. While you can use low-cost HIGH IMPEDANCE mics, you do not get the same degree of immunity to interference on the microphone cable and as a result the level of background noise may be higher. If you turn the PHANTOM POWER on, the socket provides a suitable powering voltage for professional condenser mics.



DO NOT use UNBALANCED sources with the phantom power switched on. The voltage on pins 2 & 3 of the XLR connector may cause serious damage. BALANCED dynamic mics may normally be used with phantom power switched on (contact your microphone manufacturer for guidance)

The input level is set using the input GAIN knob.

The LINE input offers the same gain range as the MIC input, but at a higher input impedance, and is 20dB less sensitive. This is suitable for most line level sources.



WARNING !
Start with the input GAIN knob turned fully anticlockwise when plugging high level sources into the LINE input to avoid overloading the input channel or giving you a very loud surprise!

Line Input

Accepts 3-pole 'A' gauge jacks, or 2-pole mono jacks which will automatically ground the 'cold' input. Use this input for sources other than mics, such as keyboards, drum machines, synths, tape machines or DI boxes. The input is BALANCED for low noise and immunity from interference, but you can use UNBALANCED sources by wiring up the jacks as shown, although you should then keep cable lengths as short as possible to minimise interference pick-up on the cable. Note that the ring must be grounded if the source is unbalanced. Set the input level using the GAIN knob, starting with the knob turned fully anticlockwise. Unplug any MIC connection when using the LINE input.

Insert Point

The unbalanced, pre-EQ insert point is a break in the channel signal path, allowing limiters, compressors, special EQ or other signal processing units to be added in the signal path. The Insert is a 3-pole 'A' gauge jack socket which is normally bypassed. When a jack is inserted, the signal path is broken, just before the EQ section.

The signal from the channel appears on the TIP of the plug and is returned on the RING, with the sleeve as a common ground.

The Send may be tapped off as an alternative pre-fade, pre-EQ direct output if required, using a lead with tip and ring shorted together so that the signal path is not interrupted.

OUTPUTS

Mix Outputs

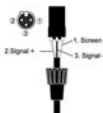

Aux Outputs Monitor Outputs



Mix Inserts

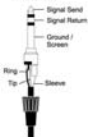

Headphones



Stereo Inputs STEREO 1/2

These accept 3-pole 'A' gauge jacks, or 2-pole mono jacks which will automatically ground the 'cold' input. Use these inputs for sources such as keyboards, drum machines, synths, tape machines or as returns from processing units. The input is **BALANCED** for low noise and immunity from interference, but you can use **UNBALANCED** sources by wiring up the jacks as shown, although you should then keep cable lengths as short as possible to minimise interference pick-up on the cable. Note that the ring must be grounded if the source is unbalanced.

Mono sources can be led to both paths by plugging into the Left jack only.

Mix Inserts

The unbalanced, pre-fade Mix insert point is a break in the output signal path to allow the connection of, for example, a compressor/limiter or graphic equaliser. The Insert is a 3-pole 'A' gauge jack socket which is normally bypassed. When a jack is inserted, the signal path is broken, just before the mix fader.

The mix signal appears on the TIP of the plug and is returned on the RING. A 'Y' lead may be required to connect to equipment with separate send and return jacks as shown below:

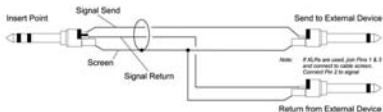

Mix Outputs

The MIX outputs are on XLR's, wired as shown, and incorporate impedance balancing, allowing long cable runs to balanced amplifiers and other equipment.

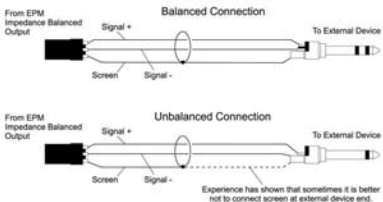

Aux Outputs

The Aux outputs are on 3-pole 'A' gauge jack sockets, wired as shown on the left, and are balanced, allowing long cable runs to balanced amplifiers and other equipment.

Headphones

The PHONES output is a 3-pole 'A' gauge jack, wired as a stereo output as shown, ideally for headphones of 200Ω or greater. 8Ω headphones are not recommended.