

# KENWOOD

# SIRIUS

**KTC-SR902/KTC-SR901 SIRIUS® Satellite Tuners**

---

**Quick-Start Guides for use with  
2003 – 2002 model Kenwood in-dash  
stereos and televisions**

For 2001 models, visit our Web site at: [www.kenwoodusa.com](http://www.kenwoodusa.com)



## KTC-SR902/KTC-SR901 SIRIUS® Satellite Tuner

### Quick-Start Guide for: KDC-X969/KDC-X869/ KDC-X769/KDC-MP922/KDC-MP822/KDC-V7022/KDC-722

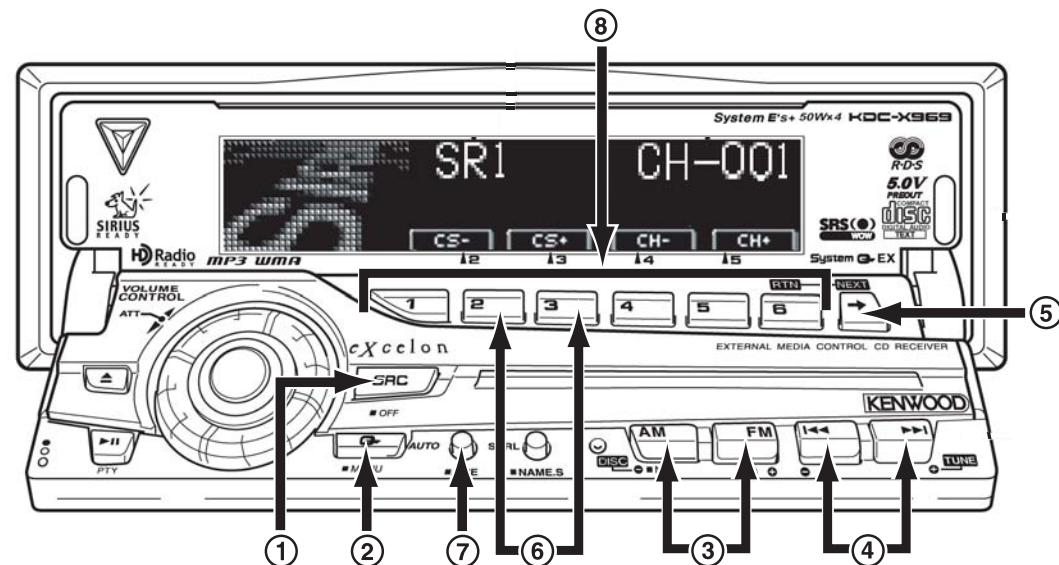

#### Step 1: Get your unit's individual Electronic Serial Number (ESN):

- Press the SRC button (1) repeatedly until "SIRIUS" appears on the display
- Press the MENU button (2) until "MENU" appears on the display
- Press the AM/FM buttons (3) to scroll through the options until "ESN XXXXXXXX" appears on the display
- Write the number down
- Press the SRC button (1) to exit

#### Step 2: Subscribe to SIRIUS Satellite

- Make sure your vehicle has the stereo on and the SIRIUS antenna has a clear view of the sky with no obstructions (buildings, garage, etc.)
- Have your Vehicle Identification Number (VIN) from the vehicle that the radio is installed in.
- Have your unit's ESN and your credit card number handy
- Contact SIRIUS on the web at [siriusradio.com](http://siriusradio.com) or call toll-free: 1-888-539-SIRIUS (7474)
- The operator will instruct you further
  - Your tuner should be able to receive SIRIUS Satellite signals almost immediately after you subscribe

#### Searching for SIRIUS categories:

- Press the NEXT button (5) repeatedly until "CS-", "CS+", "CH-", and "CH+" are displayed above the [1 - 6] buttons (8).
- Use the CS- and CS+ buttons (6) to search through the available program categories

- You must wait until all category information is acquired before operating this function again

#### Direct access tuning (using the remote):

- Press the DIRECT/OK button on the remote control
- Use the remote's number buttons to enter the stream number
- Press the >>I button (4) to go to that stream

#### Switching the Seek mode:

- Use the I<< and >>I buttons (4) to seek streams
- Press the AUTO button (7) to cycle the Seek mode between:
  - Preset Seek (Seek through your presets)
  - Channel Seek (Seek the next stream)

#### Setting stream presets:

- Use the FM button (3) to select the preset bank
- Use the I<< and >>I buttons (4) to select the stream you want to memorize
- Press the NEXT button (5) repeatedly until "1" - "6" are displayed above the [1 - 6] buttons (8).
- Hold the preset button (8) you want to memorize the stream for at least 2 seconds
  - When the stream is stored the preset number display will flash once
  - Only the preset number, not the category information is stored
  - Each preset button can store a different preset stream for each preset bank

## KTC-SR902/KTC-SR901 SIRIUS® Satellite Tuner

### Quick-Start Guide for: KDC-X569/KDC-X469/ KDC-MPV6022/KDC-MPV622/KDC-MP522/KDC-4022/ KDC-422/KDC3022/KDC-322

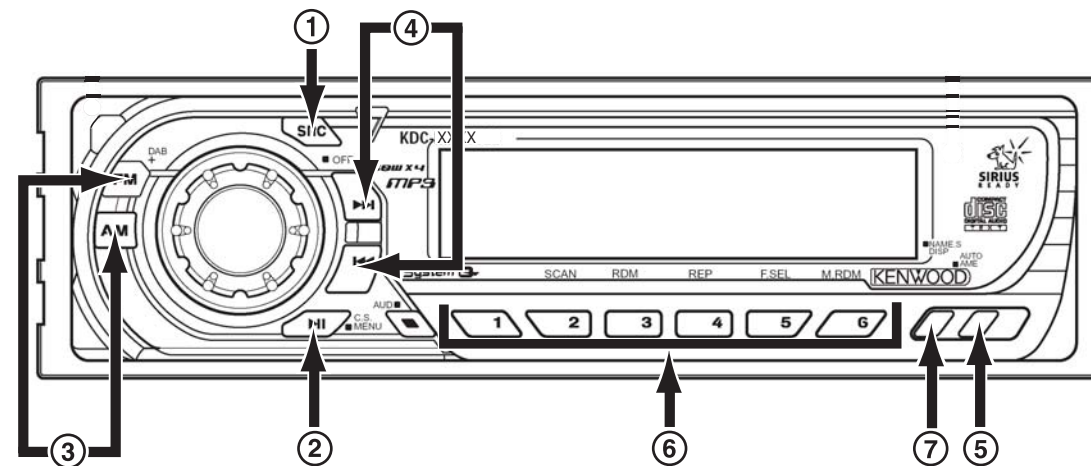

#### Step 1: Get your unit's individual Electronic Serial Number (ESN):

- Press the SRC button (1) repeatedly until "SIRIUS" appears on the display
- Hold the MENU button (2) until "MENU" appears on the display
- Press the AM/FM buttons (3) to scroll through the options until "ESN XXXXXXXX" appears on the display
- Write the number down
- Press the SRC button (1) to exit

#### Step 2: Subscribe to SIRIUS Satellite

- Make sure your vehicle has the stereo on and the SIRIUS antenna has a clear view of the sky with no obstructions (buildings, garage, etc.)
- Have your Vehicle Identification Number (VIN) from the vehicle that the radio is installed in.
- Have your unit's ESN and your credit card number handy
- Contact SIRIUS on the web at [siriusradio.com](http://siriusradio.com) or call toll-free: 1-888-539-SIRIUS (7474)
- The operator will instruct you further
  - Your tuner should be able to receive SIRIUS Satellite signals almost immediately after you subscribe

#### Searching for SIRIUS categories:

- Press the PLAY/PAUSE button (2) to enter the Category Search mode.
- Use the FM and AM buttons (3) to search through the available program categories

- Press the PLAY/PAUSE button (2) again to exit the Category Search mode.

#### Direct access tuning (using the remote):

- Press the DIRECT/OK button on the remote control
- Use the remote's number buttons to enter the stream number
- Press the >>I button (4) to go to that stream

#### Switching the Seek mode:

- Use the I<< and >>I buttons (4) to seek streams
- Press the AUTO button (5) to cycle the Seek mode between:
  - Preset Seek (Seek through your presets)
  - Channel Seek (Seek the next stream)

#### Setting stream presets:

- Use the FM button (3) to select the preset bank
- Use the I<< and >>I buttons (4) to select the stream you want to memorize
- Hold the preset button (6) you want to memorize the stream in for at least 2 seconds
  - When the stream is stored the preset number display will flash once
  - Each preset button can store a different preset stream for each preset bank

#### Changing the Display mode:

- Press the DISPLAY button (7) button to cycle through the following display options: Artist, Stream Number, Category Name, Stream Name, Song Title

# KTC-SR902/KTC-SR901 SIRIUS® Satellite Tuner

## Quick-Start Guide for: KDC-MP222

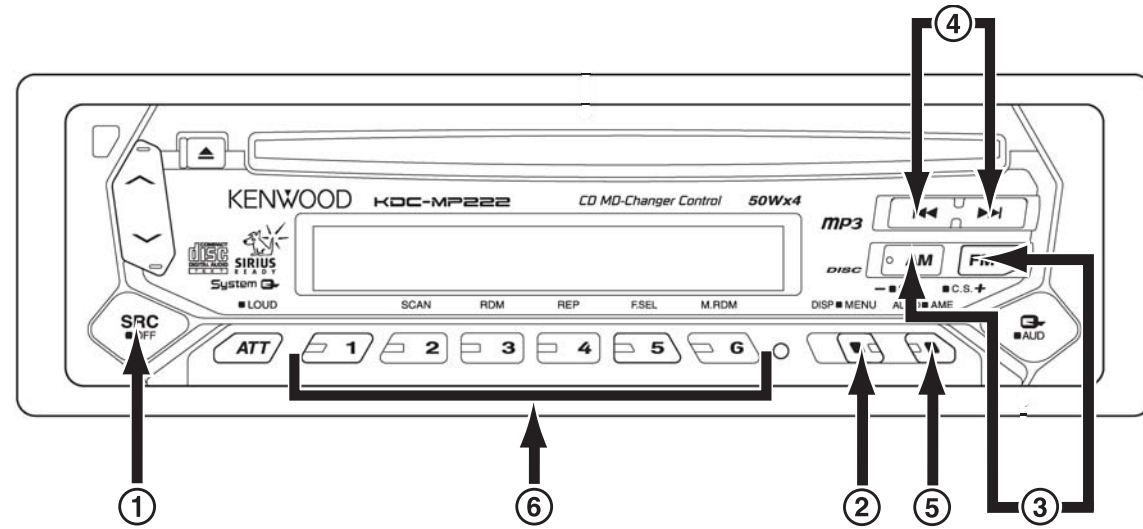

### Step 1: Get your unit's individual Electronic Serial Number (ESN):

- Press the SRC button (1) repeatedly until "SIRIUS" appears on the display
- Hold the MENU button (2) until "MENU" appears on the display
- Use the AM/FM buttons (3) to scroll through the options until "ESN XXXXXXXX" appears on the display
- Write the number down
- Press the SRC button (1) to exit

### Step 2: Subscribe to SIRIUS Satellite

- Make sure your vehicle has the stereo on and the SIRIUS antenna has a clear view of the sky with no obstructions (buildings, garage, etc.)
- Have your Vehicle Identification Number (VIN) from the vehicle that the radio is installed in.
- Have your unit's ESN and your credit card number handy
- Contact SIRIUS on the web at [siriusradio.com](http://siriusradio.com) or call toll-free: 1-888-539-SIRIUS (7474)
- The operator will instruct you further
  - Your tuner should be able to receive SIRIUS Satellite signals almost immediately after you subscribe

### Searching for SIRIUS categories:

- Press and hold the FM button (3) to enter the Category Search mode.
- Use the FM and AM buttons (3) to search through the available program categories

- Press and hold the FM button (3) again to exit the Category Search mode.

### Direct access tuning (using the remote):

- Press the DIRECT/OK button on the remote control
- Use the remote's number buttons to enter the stream number
- Press the >>I button (4) to go to that stream

### Switching the Seek mode:

- Use the I<< and >>I buttons (4) to seek streams
- Press the AUTO button (5) to cycle the Seek mode between:
  - Preset Seek (Seek through your presets)
  - Channel Seek (Seek the next stream)

### Setting stream presets:

- Use the FM button (3) to select the preset bank
- Use the I<< and >>I buttons (4) to select the stream you want to memorize
- Hold the preset button (6) you want to memorize the stream in for at least 2 seconds
  - When the stream is stored the preset number display will flash once
  - Each preset button can store a different preset stream for each preset bank

### Changing the Display mode:

Press the DISPLAY button (2) button to cycle through the following display options: Artist, Stream Number, Category Name, Stream Name, Song Title

# KTC-SR902/KTC-SR901 SIRIUS® Satellite Tuner

## Quick-Start Guide for: KDC-X959/KDC-X659/ KDC-X559/KDC-MP819/KDC-719

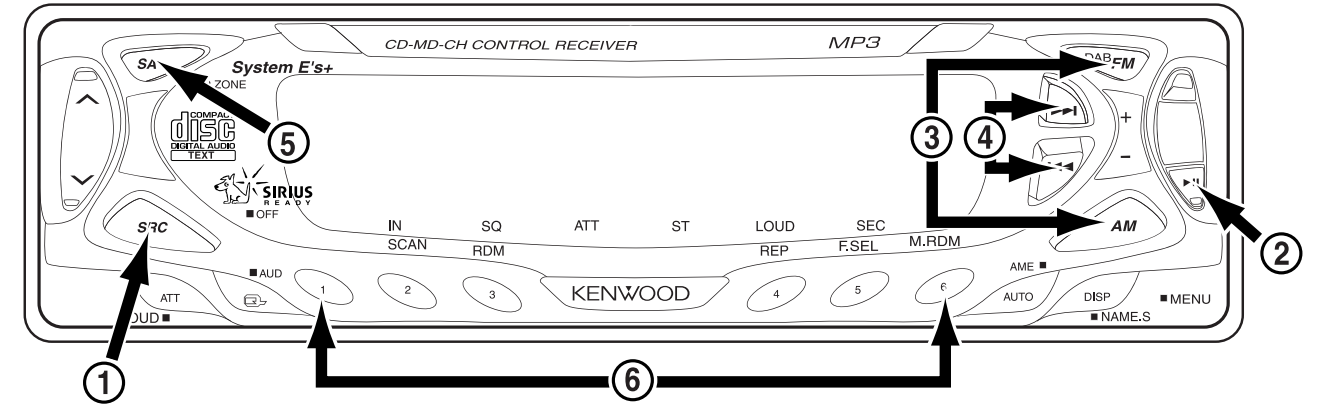

### Step 1: Get your unit's individual Electronic Serial Number (ESN):

- Press the SRC button (1) repeatedly until "SIRIUS" appears on the display
- Press the Play/Pause button (2)
- Press the AM/FM buttons (3) to scroll through the options until "ESN XXXXXXXX" appears on the display
- Write the number down
- Press the SRC button (1) to exit

### Step 2: Subscribe to the Sirius Satellite Radio service

- Make sure your vehicle has the radio "ON" and the antenna has a clear view of the sky with no obstructions (buildings, garage, etc.)
- Have your Vehicle Identification Number (VIN) from the vehicle that the radio is installed in.
- Have your unit's ESN and your credit card number handy
- Contact SIRIUS on the web at [siriusradio.com](http://siriusradio.com) or call toll-free: 1-888-539-SIRIUS (7474)
- The operator will instruct you further
  - Your tuner should be able to receive Sirius Satellite Radio signals almost immediately after you subscribe

- Press the AM/FM buttons (3) to search through the available program categories
- Press the Scan Forward and Scan Backward buttons (4) to change channels within the selected category
  - If there are no streams available in a category, the tuner will automatically switch to the next category

### Display settings setup:

- Press the SRC button (1) until "SIR" appears on the display
- Press the SA button (5) to get into the display setup mode.
- Use the AM/FM buttons (3) to control the display's top line.
- Use the Scan Forward and Scan Backward buttons (4) to control the display's bottom line.
- Press the SA button (5) again to exit the display mode

### Setting stream presets:

- Press and hold buttons 1-6 (6) after tuning to desired stream

### Searching for program categories and streams:

- Press the SRC button (1) until "SIR" appears on the display
- Press the Play/Pause button (2)

## KTC-SR902/KTC-SR901 SIRIUS® Satellite Tuner

### Quick-Start Guide for: KDC-X859/KDC-X759/KDC-MP919

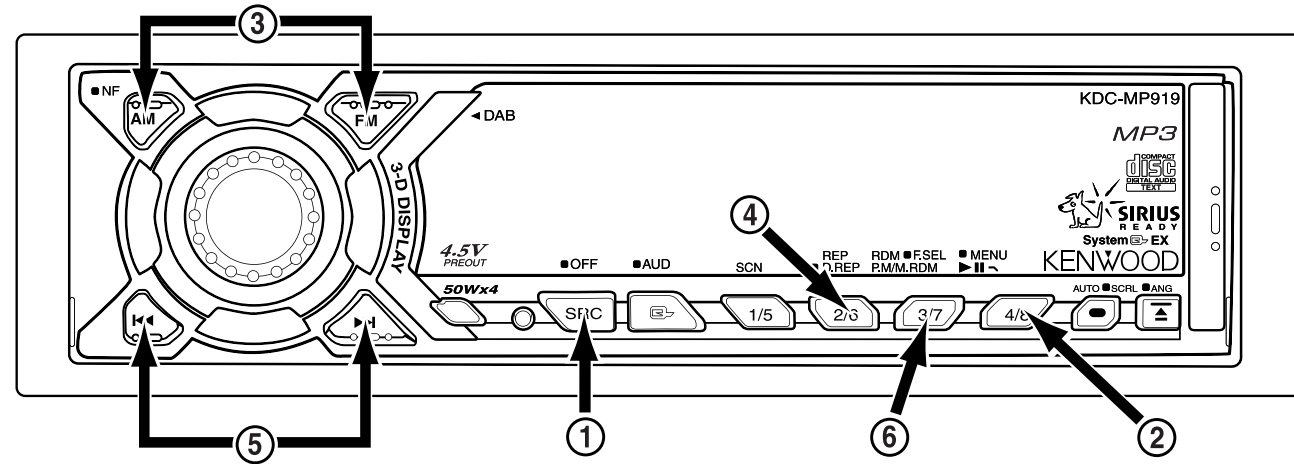

#### Step 1: Get your unit's individual Electronic Serial Number (ESN):

- Press the SRC button (1) repeatedly until "SIRIUS" appears on the display
- Press the Play/Pause button (2)
- Press the AM/FM buttons (3) to scroll through the options until "ESN XXXXXXXX" appears on the display
- Write the number down
- Press the SRC button (1) to exit

#### Step 2: Subscribe to the Sirius Satellite Radio service

- Make sure your vehicle has the radio "ON" and the antenna has a clear view of the sky with no obstructions (buildings, garage, etc.)
- Have your Vehicle Identification Number (VIN) from the vehicle that the radio is installed in.
- Have your unit's ESN and your credit card number handy
- Contact SIRIUS on the web at [siriusradio.com](http://siriusradio.com) or call toll-free: 1-888-539-SIRIUS (7474)
- The operator will instruct you further
  - Your tuner should be able to receive Sirius Satellite Radio signals almost immediately after you subscribe

#### Searching for program categories and streams:

- Press the SRC button (1) until "SIR" appears on the display
- Hold-down the Preset 2/6 button (4) until "Category Name" appears on the display

- Press the AM/FM buttons (3) to search through the available program categories
- Press the Scan Forward and Scan Backward buttons (5) to change channels within the selected category
  - If there are no streams available in a category, the tuner will automatically switch to the next category

#### Display settings setup:

- Press the SRC button (1) until "SIR" appears on the display
- Press the preset 4/8 button (2) to get into the display setup mode.
- Press the AM/FM buttons (3) until "Display Control Mode" appears on the display.
- Hold-down either the Scan Forward or Scan Backward button (5) until "Channel Number" appears on the display's top line.
- Use the AM/FM buttons (3) to control the display's top line.
- Use the Scan Forward and Scan Backward buttons (5) to control the display's bottom line.
- Press the preset 4/8 button (2) again to exit the display mode

#### Setting stream presets:

- After tuning to the desired stream, press and hold button 3/7 (6) until "Preset Memory" appears on the display
- Use the AM/FM buttons (3) to access the desired preset number
- Hold Preset button 3/7 (6) until the unit "beeps".

## KTC-SR902/KTC-SR901 SIRIUS® Satellite Tuner

### Quick-Start Guide for: KDC-X459/KDC-MPV7019/ KDC-MPV619/KDC-4019/KDC-419/KDC-319/KRC-435

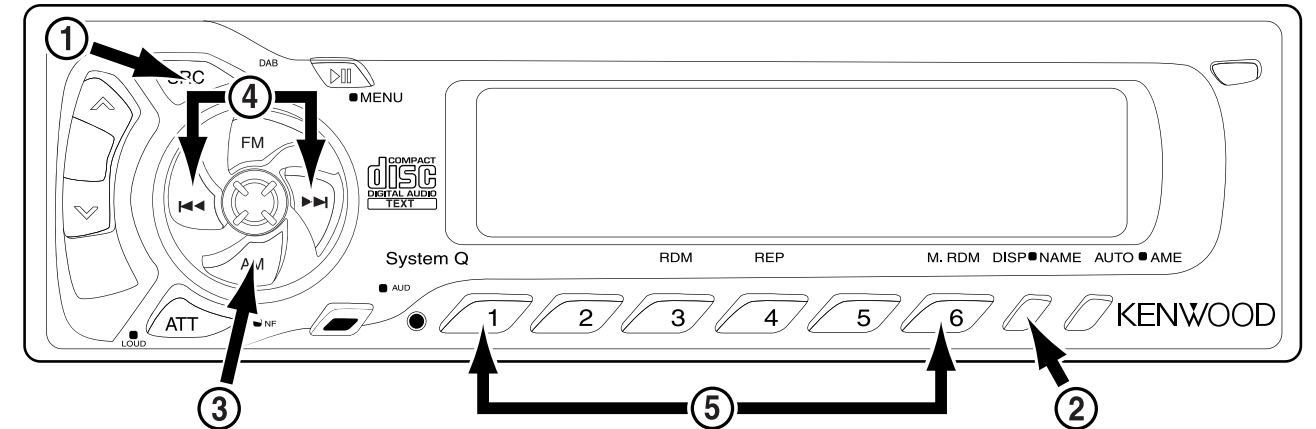

#### Step 1: Get your unit's individual Electronic Serial Number (ESN):

- Press the SRC button (1) repeatedly until "SIRIUS" appears on the display
- Press the DISP button (2) repeatedly until "ESN XXXXXXXX" appears on the display
- Write the number down
- Press the SRC button (1) to exit

#### Step 2: Subscribe to the Sirius Satellite Radio service

- Make sure your vehicle has the radio "ON" and the antenna has a clear view of the sky with no obstructions (buildings, garage, etc.)
- Have your Vehicle Identification Number (VIN) from the vehicle that the radio is installed in.
- Have your unit's ESN and your credit card number handy
- Contact SIRIUS on the web at [siriusradio.com](http://siriusradio.com) or call toll-free: 1-888-539-SIRIUS (7474)
- The operator will instruct you further
  - Your tuner should be able to receive Sirius Satellite Radio signals almost immediately after you subscribe

#### Searching for program categories and streams:

- Press the SRC button (1) until "SIR" appears on the display
- Press the AM button (3) to search through the available program categories

- Press the Scan Forward and Scan Backward buttons (4) to change channels within the selected category
  - If there are no streams available in a category, the tuner will automatically switch to the next category

#### Display settings setup:

- Press the SRC button (1) until "SIR" appears on the display
- Press the DISP button (2) to scroll the following information on the display: Channel Number & Channel Name/Channel Name/Song Title & Artist Name & Album Title/Category Name/ESN/ Channel Number
- Press the DISP button (2) again to exit the display mode

#### Setting stream presets:

- Press and hold buttons 1-6 (5) after tuning to the desired stream

# KTC-SR902/KTC-SR901 SIRIUS® Satellite Tuner

## Quick-Start Guide for: KDC-5019/KDC-519/KRC-535

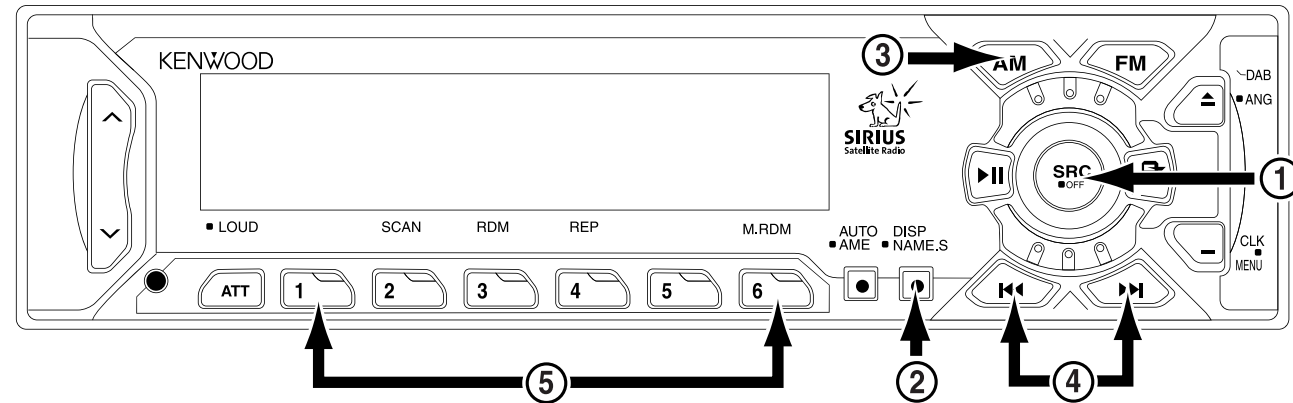

### Step 1: Get your unit's individual Electronic Serial Number (ESN):

- Press the SRC button (1) repeatedly until "SIRIUS" appears on the display
- Press the DISP button (2) repeatedly until "ESN XXXXXXXX" appears on the display
- Write the number down
- Press the SRC button (1) to exit

### Step 2: Subscribe to the Sirius Satellite Radio service

- Make sure your vehicle has the radio "ON" and the antenna has a clear view of the sky with no obstructions (buildings, garage, etc.)
- Have your Vehicle Identification Number (VIN) from the vehicle that the radio is installed in.
- Have your unit's ESN and your credit card number handy
- Contact SIRIUS on the web at [siriusradio.com](http://siriusradio.com) or call toll-free: 1-888-539-SIRIUS (7474)
- The operator will instruct you further
  - Your tuner should be able to receive Sirius Satellite Radio signals almost immediately after you subscribe

### Searching for program categories and streams:

- Press the SRC button (1) until "SIR" appears on the display
- Press the AM button (3) to search through the available program categories

- Press the Scan Forward and Scan Backward buttons (4) to change channels within the selected category
  - If there are no streams available in a category, the tuner will automatically switch to the next category

### Display settings setup:

- Press the SRC button (1) until "SIR" appears on the display
- Press the DISP button (2) to scroll the following information on the display: Channel Number & Channel Name/Channel Name/Song Title & Artist Name & Album Title/Category Name/ESN/ Channel Number
- Press the DISP button (2) again to exit the display mode

### Setting stream presets:

- Press and hold buttons 1-6 (5) after tuning to the desired stream

# KTC-SR902/KTC-SR901 SIRIUS® Satellite Tuner

## Quick-Start Guide for: KVT-911DVD

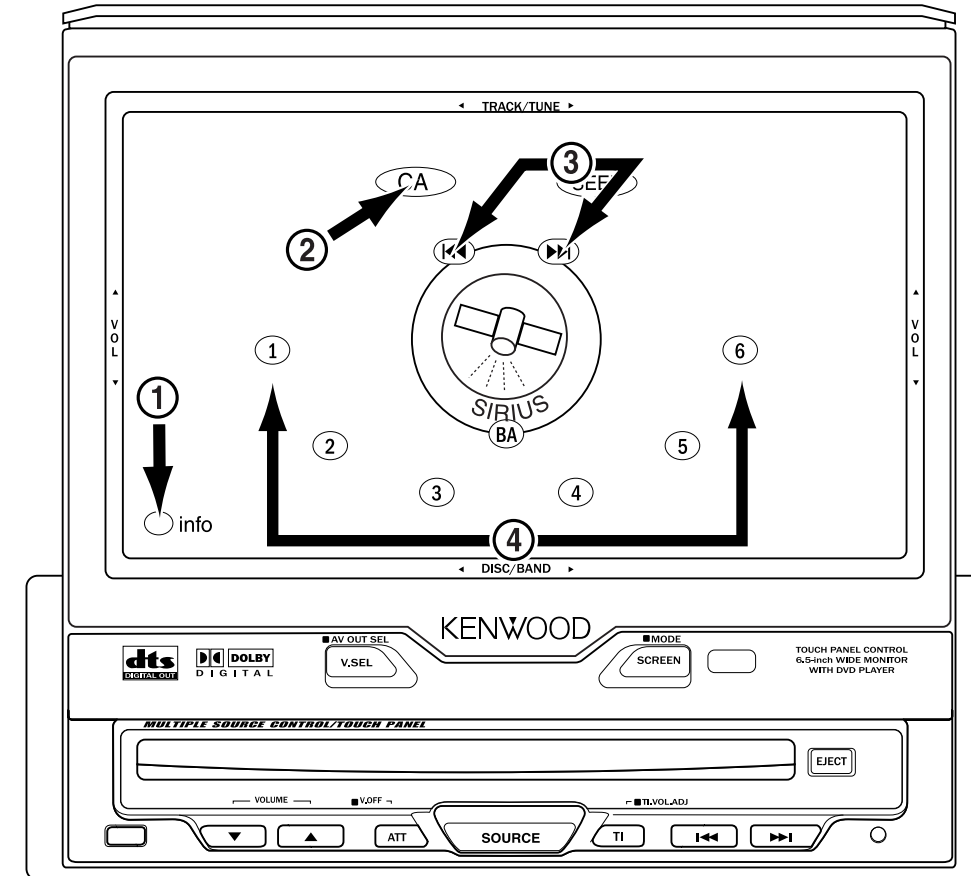

### Step 1: Get your unit's individual Electronic Serial Number (ESN):

- Touch the satellite icon on the main screen. The Sirius Satellite screen will appear
- Touch the INFO button (1). The Information screen will appear, with the ESN number at the top.
- Write the number down
- Touch the RTN button to exit

### Step 2: Subscribe to the Sirius Satellite Radio service

- Make sure your vehicle has the radio "ON" and the antenna has a clear view of the sky with no obstructions (buildings, garage, etc.)
- Have your Vehicle Identification Number (VIN) from the vehicle that the radio is installed in.
- Have your unit's ESN and your credit card number handy
- Contact SIRIUS on the web at [siriusradio.com](http://siriusradio.com) or call toll-free: 1-888-539-SIRIUS (7474)

e) The operator will instruct you further

- Your tuner should be able to receive Sirius Satellite Radio signals almost immediately after you subscribe

### Searching for program categories and streams:

- Touch the satellite icon on the main screen. The Sirius Satellite screen will appear
- Touch the CA button (2) to change categories.
- Touch the Scan Forward/Scan Backward buttons (3) to search through the available streams
  - If there are no streams available in a category, the tuner will automatically switch to the next category

### Display settings setup:

- Touch the INFO button (1). The Information screen will appear. Song title, artist and album information will scroll on the screen.
- Touch the RTN button to exit

### Setting stream presets:

- Touch and hold buttons 1-6 (4) after tuning to the desired stream

# KTC-SR902/KTC-SR901 SIRIUS® Satellite Tuner

## Quick-Start Guide for: KVT-M700

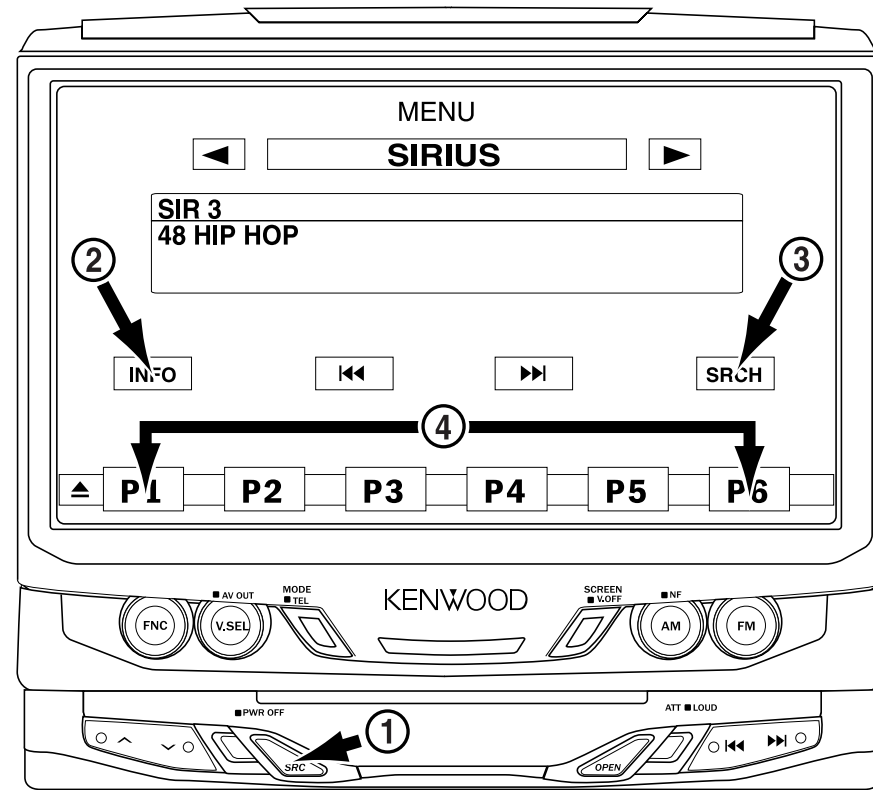

### Step 1: Get your unit's individual Electronic Serial Number (ESN):

- Press the SRC button (1) repeatedly until "SIRIUS" appears on the display
- Touch the INFO button (2). The Information screen will appear.
- Touch "ESN". The ESN number will appear on the display
- Write the number down
- Press the SRC button (1) to exit

### Step 2: Subscribe to the Sirius Satellite Radio service

- Make sure your vehicle has the radio "ON" and the antenna has a clear view of the sky with no obstructions (buildings, garage, etc.)
- Have your Vehicle Identification Number (VIN) from the vehicle that the radio is installed in.
- Have your unit's ESN and your credit card number handy
- Contact SIRIUS on the web at [siriusradio.com](http://siriusradio.com) or call toll-free: 1-888-539-SIRIUS (7474)
- The operator will instruct you further
  - Your tuner should be able to receive Sirius Satellite Radio signals almost immediately after you subscribe

### Searching for program categories and streams:

- Press the SRC button (1) repeatedly until "SIRIUS" appears on the display
  - Touch SRCH (3). The Search screen will appear.
  - Use the up/down arrow buttons to search through the available program categories
  - Touch the category you want. The available stations will appear.
  - Touch the stream you want to listen to
- If there are no streams available in a category, the tuner will automatically switch to the next category

### Display settings setup:

- Press the SRC button (1) repeatedly until "SIRIUS" appears on the display
- Touch the INFO button (2). The Information screen will appear.
- Touch the information you want and it will appear on the screen

### Setting stream presets:

- Touch and hold buttons 1-6 (4) after tuning to the desired stream

# KENWOOD

[www.kenwoodusa.com](http://www.kenwoodusa.com)

[www.kenwoodusa.com/inquiry](http://www.kenwoodusa.com/inquiry)

1-800-KENWOOD

**Main Office**  
P.O. Box 22745  
Long Beach, CA 90801-5745