

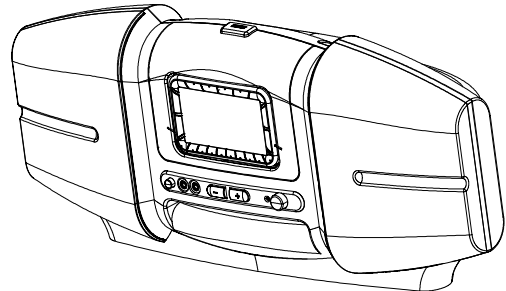

# XB9 BOOM BOX

## User Guide



Released 3-31-05.

128-7376  
1 of 16

## ***Congratulations***

You are one step closer to experiencing the latest innovation in XM Satellite Radio. XM will revolutionize your in-home or vehicle entertainment with:

- Over 150 Digital Channels Coast-to-Coast
- Over 80,000 Hours of Entertainment Each Month
- The Most 100% Commercial-Free Music
- The Most Sports Play-by-Play on Satellite Radio
- The Most Instant Traffic & Weather Channels--21 Metro Areas
- The Biggest Names in News, Talk & Entertainment

Your Audiovox XR9 Satellite Radio Receiver must be used with an adapter kit, such as the Audiovox Home Kit, Boom Box or Vehicle Kit as required by your specific installation needs. These kits are available at retailers where Audiovox main units are sold.

Audiovox Home Kit:	Part Number XH9
Audiovox Vehicle Kit:	Part Number XC9
Audiovox Boom Box	Part Number XB9

Required subscription for service sold separately. Premium Channels available at additional monthly costs. Installation costs and other fees and taxes may apply, including a one-time activation fee. All fees and programming subject to change. College sports games subject to availability. Subscriptions subject to Customer Agreement included with the XM Welcome Kit and available at **xmradio.com**. Only available in the 48 contiguous United States.

(c) 2005 XM Satellite Radio Inc. XM is a trademark of XM Satellite Radio. All rights reserved. All other trademarks are the property of their respective owners.

### ***FCC Regulations***

This unit complies with the interference limits relative to a Class B digital device, applicable under Part 15 of the FCC Rules regarding installation in a residential environment. If the unit is not installed in accordance with these instructions, it could cause harmful interference to audio or television reception.

If this condition persists after corrective action, consult your dealer or experienced installation facility.

### ***Cautions and Warnings***

1. Within the home, do not install the Receiver Boom Box in a position that obstructs viewing of any home entertainment component, such as Television, or stereo system indicators and displays.
2. Do not install or use the XB9 in locations exposed to direct sunlight, or in areas subject to extreme temperatures; do not operate the unit in moist areas, in rain, or in areas adjacent to water such as pools, hot tubs, etc.
3. When outdoors, position the XB9 and antenna where there are no obvious satellite signal obstructions such as high terrain, trees, overhangs, etc.
4. When installed indoors, unplug the AC Power Adapter from the wall outlet when the XB9 is not to be used for an extended period of time. If batteries are installed, set the Power On/Off-VOL control to the Off position to prevent unintentional battery discharge, or remove the batteries.
5. To avoid possible damage to the Receiver Boom Box caused by battery leakage, it is recommended that the batteries be removed when the Boom Box is not being used for an extended period of time.
6. Do not install or place the XB9 on an inclined or unstable surface.
7. By adhering to these warnings and safety considerations, serious accidents and/or personal injury can be avoided.

## Contents XB9

Users Guide  
P/N 128-7376



1 pc.

AC/DC Power Adapter  
(P/N 136-3990)



1 pc.

XB9 Boom Box  
(P/N 144-2477)

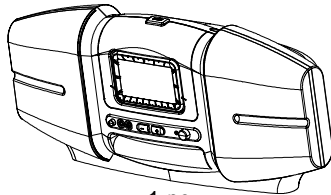

1 pc.

Antenna  
(P/N 118-1155)



1 pc.

## Installation/Wiring Precautions

1. If using the adapter, make sure the adapter cable is not connected to an AC wall outlet until all interconnections have been made and verified. The adapter power cable should be connected last.
2. Incorrect installation may cause damage to the system.
3. For antenna positioning, refer to the Antenna Aiming procedure outlined in the XR9 Satellite Radio Receiver User Guide, 128-7220.

## Setting Up and Installing Your Kit

**NOTE:** The XM® signal can be received and processed virtually anywhere as long as there are no obvious satellite signal obstructions such as high terrain, trees, overhangs, etc. In placing the antenna, therefore, these factors must be taken into account .

## Boom Box XB9 Controls

The Audiovox XM® Boom Box XB9 provides Power **ON/OFF** and **VOLUME +/-** pushbuttons, and a **MODE** pushbutton to toggle between Satellite Radio or an auxiliary audio input signal. A power-on/low battery LED is also located on the front panel.

1. **MODE Pushbutton:** This pushbutton toggles between Satellite Radio and an external audio input signal (MP3, CD, etc.) present at the AUX input jack.
2. **PHONES Jack:** Accepts a stereo headphone jack to provide private listening capability for the Boom Box.
3. **AUX Jack:** Accepts an audio input signal from an external audio device. When using the AUX audio input, turn the Receiver off to preserve battery power. Adjust the volume level of the external

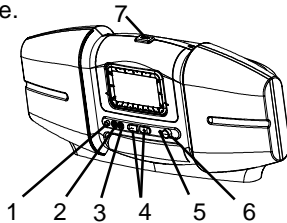

audio device to obtain an audio output from the XB9. The volume control on the external audio device should be set to mid-range.

4. **VOLUME +/- Pushbuttons:** Increase or decrease the volume of the audio output signal from the XB9. To increase the volume level, press the + pushbutton; to decrease the volume level, press the - pushbutton.

**NOTE:** When the XR9 receiver is installed, the Volume buttons on the Remote Control unit will control the audio output of the Boom Box.

5. **Power On/Low Battery LED:** The LED lights green when the Power On/Off pushbutton is pressed to apply power to the XB9.
6. **Power On/Off Switch:** When pressed, applies power to the Boom Box; the power on LED indicator (5) lights green.
7. **EJECT Button:** Press this button to release the spring-loaded XB9 mounting plate to install and remove the Receiver from the Boom Box.

### 1. Battery Installation

Your Boom Box can operate independently of AC power by installing 8 C-Cell batteries as follows:

**NOTE:** The batteries are bypassed automatically whenever the supplied AC Adapter is plugged into the DC 12V jack on the back panel.

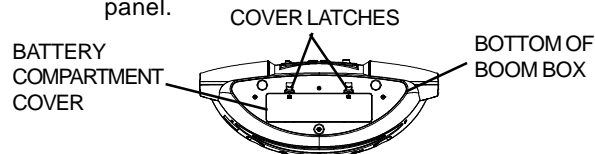

1. Turn the Boom Box upside down to access the battery compartment.
2. Push the battery cover latches forward and flip up the battery compartment cover to the open position.
3. Insert eight (8) C-Cell batteries observing battery polarity as shown; then close the cover.

### 2. Cabling Interconnections

You can begin to enjoy XM® Satellite Radio as soon as the Receiver and Boom Box Kit installation are complete. Set up your Audiovox XB9 by following the interconnect diagram.

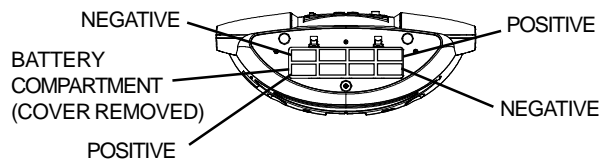

### 3. Installing the Receiver in the XB9

Install the receiver as follows:

**IMPORTANT:** Make sure boom box power is **off** before installing and removing the XR9 Receiver.

- a. Press the EJECT button at the top of the XB9; the spring-loaded mounting plate will tilt forward. Carefully line up the receiver rear spine grooves with the guide spines on the mounting plate; gently push the receiver down onto the plate.

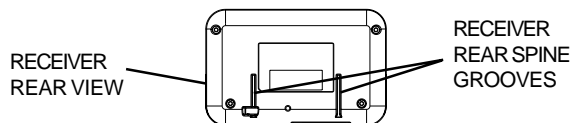

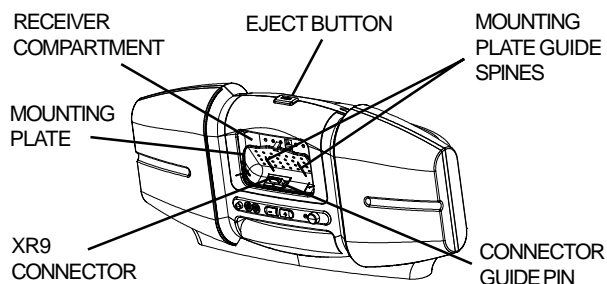

b. After making sure the connectors are properly lined up, gently press down on the receiver to mate the connectors together. The receiver should

now be attached securely to the mounting plate. Press the receiver into position in the boom box housing; it will click into place. Apply power to the XB9 by pressing the Power ON/OFF button; the LED indicator lights green. If the Receiver does not turn on at the same time, press the Power On/Off (⏻) button in the upper left corner of the Receiver front panel.

#### 4. Removing the Receiver From the XB9

Press the EJECT button on top of the Boom Box; the receiver will swing out automatically. Gently grasp each side of the Receiver at the top and pull straight up to disengage it from the mounting plate.

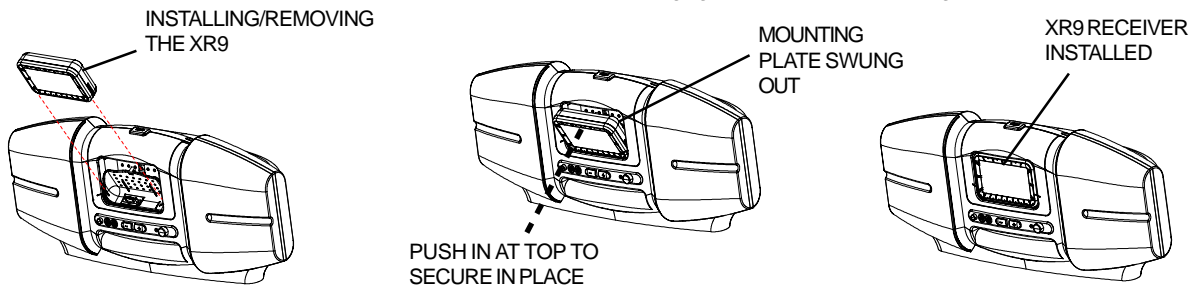

## Interconnect Diagram

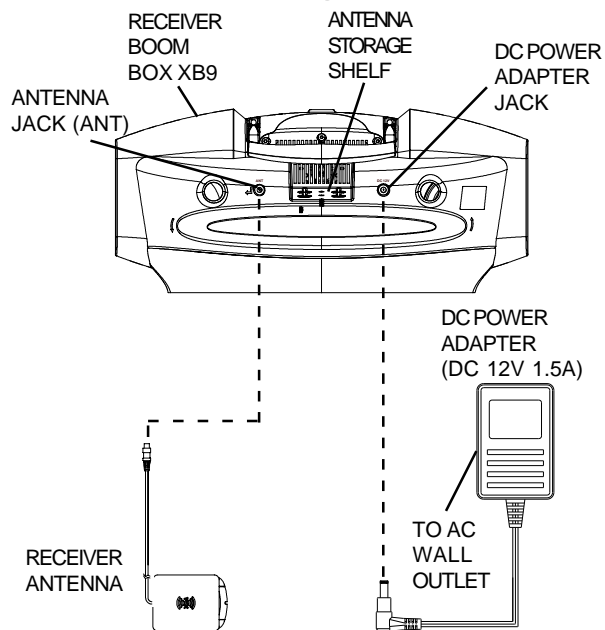

### 5. Installing the Antenna

For best reception, the supplied antenna should be placed near a window if in the house or, if outdoors, in an open area and as high as possible; some repositioning may be required to achieve optimum results. The following guidelines are recommended:

- a. In a major city, where XM ground repeaters are present, you can usually place the antenna away from a window and still achieve the desired results.
- b. You can also place the antenna outside (on the roof structure), provided it is clear of any overhead obstructions.

### 6. Antenna Placement Considerations

The antenna should be placed on a relatively flat surface whenever possible. When outdoors, the antenna may be left in its mount atop the Boom Box provided no overhead obstructions are present. To mount the antenna:



- a. Plug the antenna into the ANT connector on the back of the XB9.
- b. Leave the antenna in place on the Boom Box, or remove the antenna from its mount, uncoil the antenna lead, and place it at the preferred location inside or outside the home. If the XR9 display says "NO SIGNAL," the antenna needs to be repositioned. In addition, even if you are receiving the XM signal, it is recommended that you optimize the position of your XM Antenna as described in this section enabling you to receive the strongest possible signal and consistent, mute-free reception. Your XR9 display has two different signal-strength indicators which will help you optimize the antenna's position: The first is a basic signal strength indicator visible at the upper right corner of the display screen during normal listening. It has from zero to three vertical bars; three bars represent the strongest signal. The other is a higher-resolution signal-

strength indicator screen showing Terrestrial and Satellite indications which allow you to optimally aim your XM Antenna. To access and use this screen, refer to the XR9 Satellite Radio Receiver User Guide (128-7220).

#### **7. Positioning the XM Antenna**

The antenna supplied with the XB9 is a high-gain type that can receive XM's signal from one of XM's satellites and/or, depending on where you live, XM's terrestrial repeaters. It is recommended that the antenna be positioned near a south-facing window or outdoors with a clear view of the southeastern sky in order to receive the satellite signal. In some cases, it will be possible to receive XM's signal through standard home walls or a roof. To position your antenna, first set up the Boom Box as described earlier in this user guide. Next, position the antenna until you receive the strongest possible satellite signal. If the satellite signal is not available, you can optimize it for a terrestrial signal (where available).

**NOTE:** Do not cut the antenna cable and attempt to splice it or attach alternative connectors or cable. The cable and connectors used in your XB9 are specially chosen and attached at the factory to ensure that they will work with XM's unique frequency band. Use an XM-approved antenna extension kit from your local consumer electronics retailer. Failure to do so could damage the unit.

- a. Apply power to the XB9 Boom Box as outlined previously in paragraph 3b and obtain an audio output. If no audio is heard, move the antenna to different positions on the surface until an audio output is heard. This is the desired antenna position and should be marked.
- b. After determining the optimum position, turn off XB9 and Receiver power, disconnect the power adapter from the wall outlet receptacle (if indoors) and disconnect the antenna cable.
- c. When indoors, plan the routing of the antenna cable to the cradle. Make sure you avoid any obstructions that could crimp, kink or twist the

cable; use protective grommets wherever rough openings are encountered.

- d. If the antenna is mounted outside, route the cable from the antenna position to the interior of the home, working the cable through the basement, under a window sill, etc.; make adjustments and take up slack whenever necessary.
- e. If outdoors, either leave the antenna in place atop the XB9, or remove the antenna and find a location free from overhead obstructions such as tree branches, or the roof of a tent or other temporary shelter.
- f. Plug the antenna cable into the ANT connector on the back of the Boom Box.
- g. If not using battery power as the primary power source, plug the female end of the DC Adapter cable into the "DC 12V receptacle on the rear of the Boom Box.
- h. Plug the other end of the DC adapter cable into a 110-volt wall receptacle. Apply power to the Boom Box and Receiver.
- i. You are now ready to enjoy XM programming outdoors or within your home.

## ***Specifications***

Nominal Output Power per Channel	5.0 Watts Rms
Total Harmonic Distortion (THD)	0.3% at 1 Watt
Frequency Response	30Hz to 20kHz
Signal-to-Noise Ratio	>65dB Maximum
Speaker Impedance	8 Ohms Nominal
Headphone Output Impedance	32 Ohms
Headphone Output Level	800 mV (Maximum)
Headphone Connector Type	3.5 mm Stereo Jack
Auxiliary Input Impedance	8K-Ohms Nominal
Auxiliary Input Level	2.0 Volts (Maximum)
Auxiliary Connector Type	3.5 mm Stereo Jack
Equalizer Frequency	-6dB Nominal at 2.5kHz
Overall XB9 Dimensions	19.1" W x 7.5" D x 8.43" H 485 mmW x 192 mmD x 214 mmH
Overall AC Adapter Dimensions	1.92" D x 3.3" H x 2.2" W 48.7mmD x 84mmH x 56mmW
XB9 Weight	6.75 Lbs. (3.06Kg)

## **Maintenance**

### ***Periodic Inspection***

The XB9 Boom Box should be inspected periodically for external damage. At least once every 30 days of use, perform the following checks:

1. Inspect the Receiver connector for loose, bent or broken pins, misalignment, etc.; make sure the XR9 connector is intact and exhibits no apparent damage.
2. Check the VOL control for freedom of motion without binding of any kind.
3. Check that the MODE pushbutton operates correctly in that it toggles between the Satellite Radio output and the AUX input.
4. Make sure the antenna connector at the rear of the unit is free from damage of any kind and that the antenna lead plug mates correctly and securely.
5. Make sure the DC 12V connector at the rear of the unit is also free from damage of any kind and that the AC Adapter plug mates correctly and securely.
6. Check the antenna for any physical damage; make sure the antenna lead is secure and not nicked or frayed.
7. Inspect the overall Boom Box case and speaker grilles for damage such as nicks, scratches punctures, etc.

### ***Cleaning the XB9 Boom Box***

When cleaning the Boom Box, make sure the AC Adapter is unplugged from the power source. Do not use liquid cleaners or aerosol cleaners. Use a lint-free cloth lightly dampened with water for cleaning the exterior of the Boom Box only.

## Troubleshooting

FAULT	PROBABLE CAUSE	REMEDY
System does not turn on	Receiver power is set to off	Turn Receiver power on using the XR9 Power On/Off button
	Batteries not installed or installed incorrectly	Install batteries observing correct polarity
XB9 does not operate using batteries	As long as the AC power connector is attached to the rear panel, operation is disabled	Remove power connector from rear panel of XB9
Intermittent operation	Low battery level	Replace batteries
ANTENNA error message	Satellite antenna not connected to XB9 rear panel	Connect satellite antenna to XB9 rear panel ANT jack
	XR9 Receiver not firmly seated in cradle mounting plate	Press firmly down on the Receiver to ensure that the connector is firmly mated to the Boom Box connector
NO SIGNAL message	Check for obstacles over or around antenna	Change location to eliminate nearby obstacles (bridges, etc.)
No sound from XB9 speakers	Headphones installed	Remove headphones
	Incorrect mode (source) selection	Press MODE pushbutton for desired audio signal (Satellite Radio or AUX input)



**AUDIOVOX®**

## **12 MONTH LIMITED WARRANTY**

AUDIOVOX CORPORATION (the Company) warrants to the original retail purchaser of this product that should this product or any part thereof, under normal use and conditions, be proven defective in material or workmanship within 12 months from the date of original purchase, such defect(s) will be repaired or replaced with new or reconditioned product (at the Company's option) without charge for parts and repair labor.

To obtain repair or replacement within the terms of this Warranty, the product is to be delivered with proof of warranty coverage (e.g. dated bill of sale), specification of defect(s), transportation prepaid, to an approved warranty station or the Company at the address shown below.

This Warranty does not extend to the elimination of externally generated static or noise, to costs incurred for installation, removal or reinstallation of the product, damage to speakers, accessories, or vehicle and home electrical systems, malfunction of satellite transmissions, repeater signal or receiver unit.

This Warranty does not apply to any product or part thereof which, in the opinion of the Company, has suffered or been damaged through alteration, improper installation, mishandling, misuse, neglect, accident, or by removal or defacement of the factory serial number/bar code label(s). THE EXTENT OF THE COMPANY'S LIABILITY UNDER THIS WARRANTY IS LIMITED TO THE REPAIR OR REPLACEMENT PROVIDED ABOVE AND, IN NO EVENT, SHALL THE COMPANY'S LIABILITY EXCEED THE PURCHASE PRICE PAID BY PURCHASER FOR THE PRODUCT.

This Warranty is in lieu of all other express warranties or liabilities. ANY IMPLIED WARRANTIES, INCLUDING ANY IMPLIED WARRANTY OF MERCHANTABILITY, SHALL BE LIMITED TO THE DURATION OF THIS WRITTEN WARRANTY. ANY ACTION FOR BREACH OF ANY WARRANTY HEREUNDER INCLUDING ANY IMPLIED WARRANTY OF MERCHANTABILITY MUST BE BROUGHT WITHIN A PERIOD OF 48 MONTHS FROM DATE OF ORIGINAL PURCHASE. IN NO CASE SHALL THE COMPANY BE LIABLE FOR ANY CONSEQUENTIAL OR INCIDENTAL DAMAGES FOR BREACH OF THIS OR ANY OTHER WARRANTY, EXPRESS OR IMPLIED, WHATSOEVER. No person or representative is authorized to assume for the Company any liability other than expressed herein in connection with the sale of this product.

Some states do not allow limitations on how long an implied warranty lasts or the exclusion or limitation of incidental or consequential damage so the above limitations or exclusions may not apply to you. This Warranty gives you specific legal rights and you may also have other rights which vary from state to state.

**U.S.A. :** AUDIOVOX CORPORATION, 150 MARCUS BLVD., HAUPPAUGE, NEW YORK 11788 • 1-800-645-4994

**CANADA :** CALL 1-800-645-4994 FOR LOCATION OF WARRANTY STATION SERVING YOUR AREA

1287351

THIS PAGE LEFT BLANK INTENTIONALLY

-15-

128-7376  
15 of 16



For Customer Service  
Visit Our Website At  
**www.audiovox.com**  
Product Information, Photos,  
FAQ's, Owner's Manuals

---

© 2005 Audiovox Electronics Corporation, 150 Marcus Blvd., Hauppauge, New York 11788

128-7376

-16-

128-7376

16 of 16