

# **GXM 30<sup>®</sup>**

*XM Radio Smart Antenna*

*owner's manual*



© Copyright 2005 Garmin Ltd. or its subsidiaries

Garmin International, Inc.  
1200 East 151<sup>st</sup> Street,  
Olathe, Kansas 66062, U.S.A.  
Tel. 913/397.8200 or 800/800.1020  
Fax 913/397.8282

Garmin (Europe) Ltd.  
Unit 5, The Quadrangle, Abbey Park  
Industrial Estate, Romsey, SO51 9DL, U.K.  
Tel. 44/0870.8501241  
Fax 44/0870.8501251

Garmin Corporation  
No. 68, Jangshu 2<sup>nd</sup> Road, Shijr, Taipei  
County, Taiwan  
Tel. 886/2.2642.9199  
Fax 886/2.2642.9099

All rights reserved. Except as expressly provided herein, no part of this manual may be reproduced, copied, transmitted, disseminated, downloaded or stored in any storage medium, for any purpose without the express prior written consent of Garmin. Garmin hereby grants permission to download a single copy of this manual onto a hard drive or other electronic storage medium to be viewed and to print one copy of this manual or of any revision hereto, provided that such electronic or printed copy of this manual must contain the complete text of this copyright notice and provided further that any unauthorized commercial distribution of this manual or any revision hereto is strictly prohibited.

Information in this document is subject to change without notice. Garmin reserves the right to change or improve its products and to make changes in the content without obligation to notify any person or organization of such changes or improvements. Visit the Garmin Web site ([www.garmin.com](http://www.garmin.com)) for current updates and supplemental information concerning the use and operation of this and other Garmin products.

Garmin<sup>®</sup>, is registered trademarks of Garmin Ltd. or its subsidiaries and may not be used without the express permission of Garmin. XM WX and XM are trademarks of XM Satellite Radio Inc.

July 2005

Part Number 190-00535-00 Rev. B

Printed in Taiwan



## Warning

**Failure to avoid the following potentially hazardous situations could result in an accident or collision resulting in death or serious injury.**

When installing the GXM 30 in a vehicle, place the unit securely so that it does not interfere with vehicle operating controls or obstruct the driver's view of the road (see diagram).

When navigating in an aircraft, use the GXM 30 only as an aid for VFR navigation. Use weather data only as an aid to situational awareness.

This unit contains magnets which may cause compass deviation.



## Caution

**Failure to avoid the following potentially hazardous situations may result in injury or property damage.**

Use the GXM 30 only as a navigational aid. Do not attempt to use the GXM 30 for any purpose requiring precise measurement of direction, distance, location, or topography. This product should not be used to determine ground proximity for aircraft navigation.

**Notice to State of California Drivers:** California Vehicle Code Section 26708 (a) (1) provides that “No person shall drive any motor vehicle with any object or material placed, displayed, installed, affixed, or applied upon the windshield or side or rear windows.” Drivers in California should not use the suction mount on their windshield or side or rear windows. Garmin does not take any responsibility for any fines, penalties, or damages that may be incurred as a result of disregarding this notice.

## INTRODUCTION

### Preface

Congratulations on choosing one of the most advanced weather systems available! The GXM 30 XM Radio Smart Antenna provides graphical and textual marine, aviation, and automotive XM WX weather information that can be viewed on your Garmin unit. Operation of the GXM 30 XM Radio Smart Antenna requires a subscription to the XM WX Satellite Weather service. Additionally, the GXM 30 XM Radio Smart Antenna offers music, news, and talk programming capability with a subscription to the XM Radio service. Hardware and XM subscriptions are sold separately.

This manual covers the XM WX Weather and XM Radio features of the GXM 30 XM Radio Smart Antenna when viewed on a Garmin unit. To get the most out of your new system, take the time to go through this manual and the unit *Owner's Manual*. Operational procedures are found in the unit *Owner's Manual*. This manual discusses how to connect the GXM 30 XM Radio Smart Antenna, how to subscribe to XM WX Weather and XM Radio services, and provides detailed information about weather and audio features.

### Terminology used throughout this manual

- This manual refers to the GXM 30 XM Radio Smart Antenna as the GXM 30.
- All Garmin products that are compatible with the GXM 30 are referred to as “Garmin unit” throughout this manual.
- This manual uses the term **Warning** to indicate a potentially hazardous situation, which, if not avoided, could result in death or serious injury.
- This manual uses the term **Caution** to indicate a potentially hazardous situation, which, if not avoided, may result in minor injury or property damage. It may also be used without the symbol to alert you to avoid unsafe practices.

## Product Registration

Help us better support your equipment purchase by completing our online registration today! Have the serial number of your GXM 30 ready, connect to our Web site ([www.garmin.com](http://www.garmin.com)) and click the Product Registration link on the Home page. Record your serial number below for a quick reference.

### Serial Number for GXM 30

Use this area to record the serial number (8-digit number located on the bottom of your unit) in case it is lost, stolen, or needs service. Be sure to keep your original sales receipt in a safe place or attach a photocopy inside the manual.

Serial Number:

|  |  |  |  |  |  |  |  |
|--|--|--|--|--|--|--|--|
|  |  |  |  |  |  |  |  |
|--|--|--|--|--|--|--|--|

## XM WX Weather and XM Radio ID

Use this area to record the radio ID numbers (8-digit number located on the Information sub tab of your unit) in case your unit is lost or stolen. XM Satellite Radio can deactivate these radio codes when you call.

XM Radio ID Number

|  |  |  |  |  |  |  |  |
|--|--|--|--|--|--|--|--|
|  |  |  |  |  |  |  |  |
|--|--|--|--|--|--|--|--|

[www.XMWXweather.com](http://www.XMWXweather.com)

XM WX Satellite Weather Listener Care Center

|   |            |   |           |
|---|------------|---|-----------|
| <b>Introduction</b> .....                           | <b>iii</b> | <b>Marine Warnings</b> .....                      | <b>19</b> |
| <b>Preface</b> .....                                | <b>iii</b> | <b>Buoy Reports</b> .....                         | <b>20</b> |
| Terminology used throughout this manual .....       | iii        | <b>METAR</b> .....                                | <b>21</b> |
| Product Registration .....                          | iv         | <b>AIRMET</b> .....                               | <b>22</b> |
| XM WX Weather and XM Radio ID .....                 | iv         | <b>SIGMET</b> .....                               | <b>23</b> |
| <b>Getting Started</b> .....                        | <b>1</b>   | <b>TFR</b> .....                                  | <b>24</b> |
| <b>Unit Overview</b> .....                          | <b>1</b>   | <b>Echo Tops</b> .....                            | <b>25</b> |
| <b>Connecting the GXM 30 to a Garmin Unit</b> ..... | <b>2</b>   | <b>Freezing Level</b> .....                       | <b>26</b> |
| <b>Subscribing to XM WX Weather and Radio</b> ..... | <b>3</b>   | <b>Forecast</b> .....                             | <b>26</b> |
| <b>XM WX Weather Features</b> .....                 | <b>5</b>   | <b>TAF</b> .....                                  | <b>27</b> |
| <b>Displaying Weather Information</b> .....         | <b>5</b>   | <b>XM Radio</b> .....                             | <b>27</b> |
| <b>NEXRAD Radar</b> .....                           | <b>6</b>   | <b>Appendix</b> .....                             | <b>28</b> |
| <b>Satellite Mosaic</b> .....                       | <b>7</b>   | <b>Specifications</b> .....                       | <b>28</b> |
| <b>Lightning</b> .....                              | <b>8</b>   | Physical Specifications .....                     | 28        |
| <b>Storm Cells</b> .....                            | <b>9</b>   | Power .....                                       | 28        |
| <b>Hurricanes</b> .....                             | <b>10</b>  | Performance .....                                 | 28        |
| <b>Surface Winds</b> .....                          | <b>11</b>  | <b>NEXRAD Overview</b> .....                      | <b>30</b> |
| <b>Winds Aloft</b> .....                            | <b>12</b>  | NEXRAD Description .....                          | 30        |
| <b>Surface Pressure</b> .....                       | <b>13</b>  | NEXRAD Abnormalities .....                        | 30        |
| <b>Fronts</b> .....                                 | <b>14</b>  | NEXRAD Limitations .....                          | 30        |
| <b>Visibility</b> .....                             | <b>15</b>  | NEXRAD Intensity .....                            | 31        |
| <b>County Warnings</b> .....                        | <b>16</b>  | <b>FCC Compliance</b> .....                       | <b>32</b> |
| <b>Water Temperature</b> .....                      | <b>17</b>  | <b>Limited Warranty</b> .....                     | <b>33</b> |
| <b>Wave Period</b> .....                            | <b>17</b>  | <b>Software License Agreement</b> .....           | <b>35</b> |
| <b>Wave Direction</b> .....                         | <b>18</b>  | <b>XM Satellite Radio Service Agreement</b> ..... | <b>35</b> |
| <b>Wave Height</b> .....                            | <b>18</b>  | <b>Weather Data Warranty</b> .....                | <b>36</b> |
|   |            | <b>TFR Data</b> .....                             | <b>37</b> |

## Unit Overview

GXM 30 Radio Smart Antenna



USB Connector

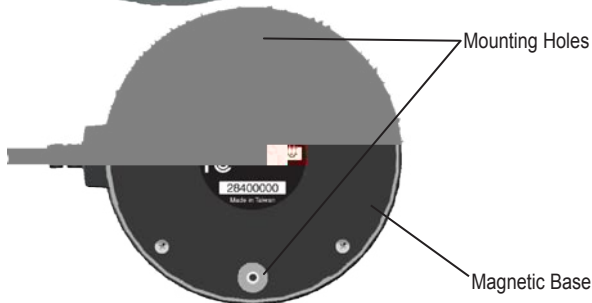

Mounting Holes

Magnetic Base

## GETTING STARTED

### UNIT CARE

**Cleaning** - The unit's case is constructed of high quality material and does not require user maintenance other than cleaning. Clean the unit housing using a lightly-dampened cloth with a mild detergent solution and then wipe dry. Avoid chemical cleaners and solvents that may damage plastic components. Do not apply cleaner to the electrical contacts on the front of the unit.

**Storage** - Do not store the GXM 30 where exposure to temperature extremes may occur, as permanent damage may result.

### SERVICING YOUR UNIT

The Garmin GXM 30 has no user-serviceable parts. Should you ever encounter a problem with your unit, take it to an authorized Garmin dealer for repairs.

The GXM 30 is fastened shut with screws. Any attempt to open the case to change or modify the unit in any way voids your warranty and may result in permanent damage to the equipment.



## Connecting the GXM 30 to a Garmin Unit

Position the GXM 30 where it has a clear view of the sky. This can be on the outside of the vehicle or behind the windscreen of the vehicle. Connect the GXM 30 to the USB port on the Garmin unit.

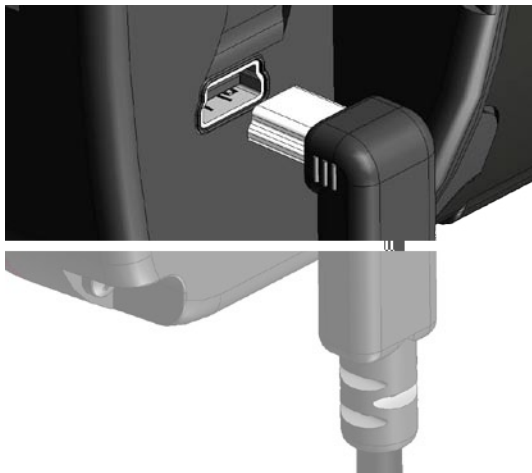

## Subscribing to XM WX Weather and Radio

With the GXM 30 connected, contact XM Satellite Radio to activate your XM WX weather and audio subscription service. Follow the instructions below. Complete Steps 1-3 BEFORE calling XM Satellite Radio:

### Step 1: Check the System Setup

Make certain the GXM 30 is connected to the Garmin unit.

### Step 2: Turn on your System

Place the GXM 30 where it has a clear view of the sky and turn on the Garmin unit. This automatically turns on the GXM 30.

### Step 3: Identify Radio ID

On the Garmin unit, press the **MENU** key twice to display the Main Menu. A list of tabs appear down the left-hand side of the Main Menu. Using the **ROCKER** key, highlight the **XM** tab and select the **Information** sub tab.

Write down the Radio ID number. Have the ID number, your billing address and other billing information ready when you contact XM.

Select the Audio sub tab (it is next to the Information sub tab). Verify that XM Preview appears in the Radio Tuning box.

### Step 4: Set up the XM Account

Contact XM by phone at **800-985-9200**. After providing the required information, the XM representative activates the account and sends out an XM signal to activate the GXM 30.

For answers to other XM questions you can call the above number or visit [www.XMWXweather.com](http://www.XMWXweather.com).

### Step 5: Confirm all Components of your Service Package

**XM WX Weather:** Keep your Garmin unit turned on to ensure you receive the XM signal. The XM signal is being received when the components of the selected service package are displayed in the **Weather Products** list on the Information sub tab. Do not turn off the Garmin unit until the name of the selected service package is displayed in the **Service Level** field (see Step 6).

**XM Radio:** Highlight the **Audio** sub tab and verify that channels 7, 9, 47, and 122 are being received. This indicates that all channels on XM's basic radio service are being received. If within an hour the XM WX Weather and/or the XM Radio service has not activated, call XM WX customer care at **800-985-9200** to validate the activation of XM services. The customer care representative can refresh the activation signal or you can do this yourself a [www.xmradio.com/refresh](http://www.xmradio.com/refresh) by entering your radio ID where requested.

### Step 6: Save the Service Package

After the service package name appears in the **Service Level** field, turn off the Garmin unit.

### Step 7: Add Features to your Unit

When you turn on the GXM 30 after completing Step 6, you are ready to add weather features to the unit's Map Page and set your new favorite channels.

#### XM Information

| GPS      | Audio                   | Information    |
|----------|-------------------------|----------------|
| Radio ID | TKSU708B                |                |
| Weather  | Service Level           | Master Mariner |
| XM       | Weather Products        |                |
| Flights  | AIRMETs                 | 00:00          |
| Route    | Buoy Reports            | -00:04         |
|          | City Forecasts          | -00:05         |
|          | Coastal Waters Forecast | -00:04         |
|          | County Warnings         | -00:04         |
|          | Echo Tops               | -00:44         |
|          | Freezing Level          | -00:03         |

## XM WX WEATHER FEATURES

### Displaying Weather Information

The GXM 30 receives XM WX Weather data and shows it on the Garmin unit's Map Page and other screens throughout the unit. The weather data for each feature comes from reputable weather data centers such as the National Weather Service and the Hydrometeorological Prediction Center. (See the XM WX Satellite Weather Web site at <http://weather.xmradio.com/weather> for more information.) Any weather feature can change in appearance or interpretation if the source that provides the information changes. XM WX Weather data is broadcast at set rates (See page 30 for all weather-related broadcast rates). For example, NEXRAD Radar data is broadcast at five minute intervals. When the Garmin unit is turned on or when a new feature is selected, the GXM 30 has to receive new data before it can be shown. You may experience a delay before weather data or a new feature appears on the map.

#### To display weather features on the Garmin unit's Map Page:

1. Press the **MENU** key.
2. Highlight **Show Weather**, and press **ENTER**.

#### Displaying Weather

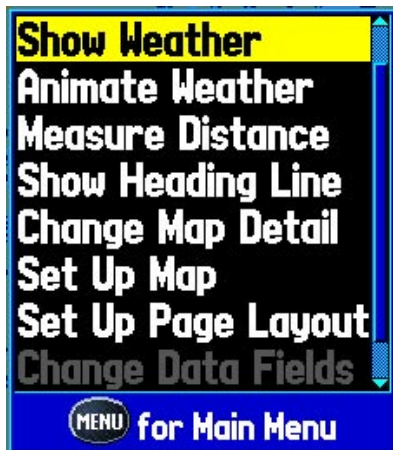

To display weather features on the map, press the **MENU** key, highlight **Show Weather**, and press **ENTER**.

## NEXRAD Radar

NEXRAD or NEXt Generation Weather RADar displays precipitation from very light rain and snow up to strong thunderstorms in varying shades and colors. In the lower left corner of the screen is a Time Stamp. The Time Stamp displays the elapsed time since the National Weather Service provided the displayed information. To display a legend showing the colors for Rain, Mix, and Snow, press **MENU**, highlight **Weather Legend**, and press **ENTER**. NEXRAD can be displayed independently or with a variety of other weather information. For information on NEXRAD Limitations, Abnormalities, and Intensity, see pages 30-31.

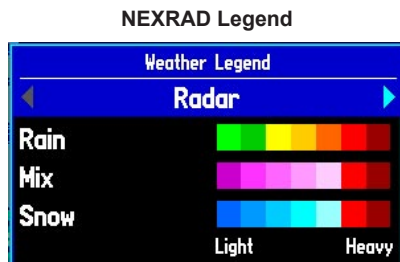
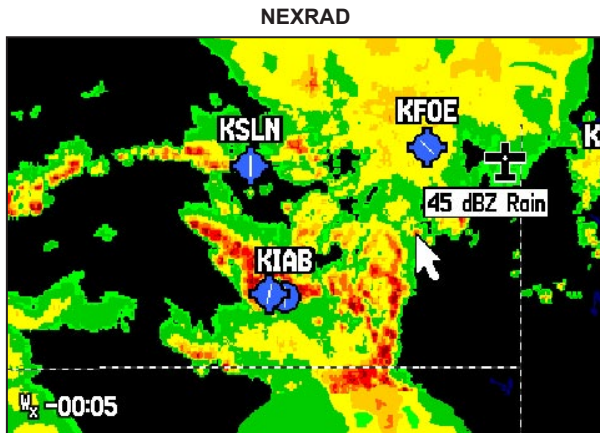

## Satellite Mosaic

Satellite Mosaic displays infrared composite images of cloud cover taken by geostationary weather satellites. The Satellite Mosaic provides up to seven levels of cloud cover.

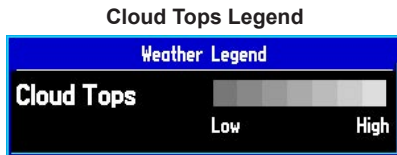
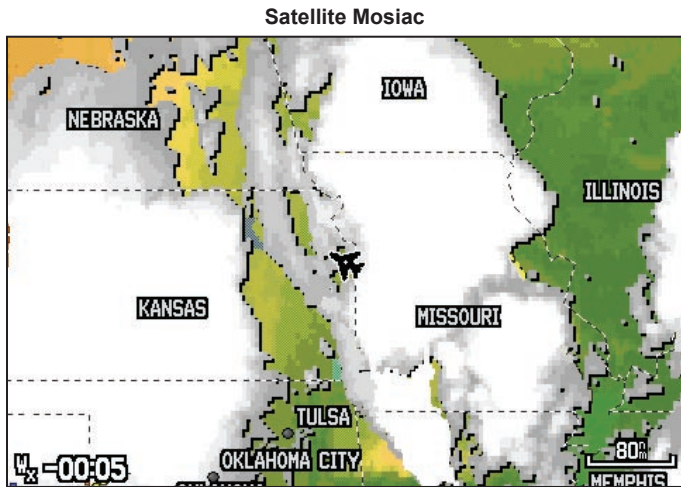

## Lightning

Lightning strikes are represented by lightning bolt icons, as shown in the images below. Lightning appears on the map if strikes were detected within the last seven minutes. The ground-based lightning detection network only detects cloud-to-ground lightning.

Lightning bolts indicate a cloud-to-ground lightning strike.

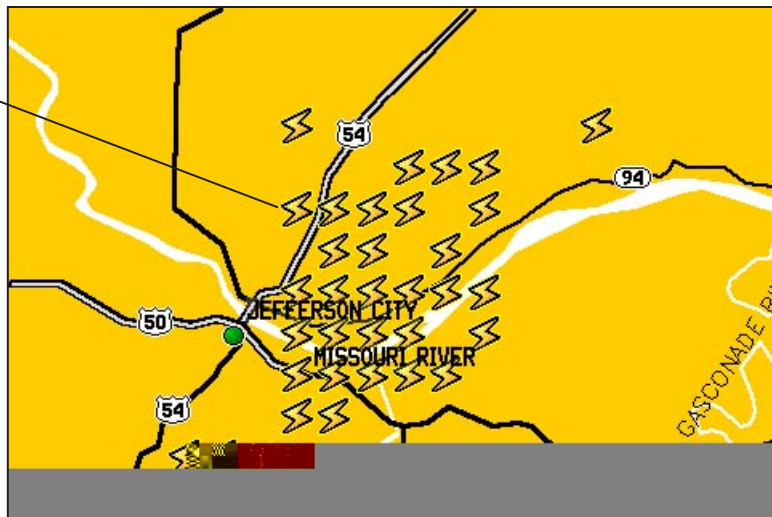

## Storm Cells

The Storm Cells feature displays storms as well as the storm's projected path in the immediate future.

Marine and Automotive units also show the size of the storm cell. The direction of the red cone indicates the projected path of the storm cell. The red bars that appear in the cone indicate where the storm will be in the future. Each bar represents 15 minutes.

Aviation units show the direction of the storm with an arrow. The tip of the arrow indicates where the storm should be in 15 minutes. Critical information about the storm cell can be viewed by selecting the storm cell with the map pointer.

**Automotive and Marine**

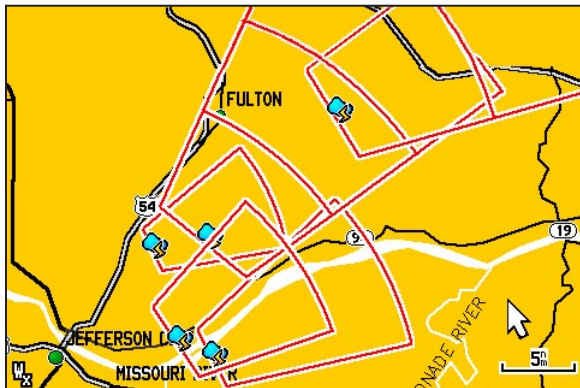

**Aviation**

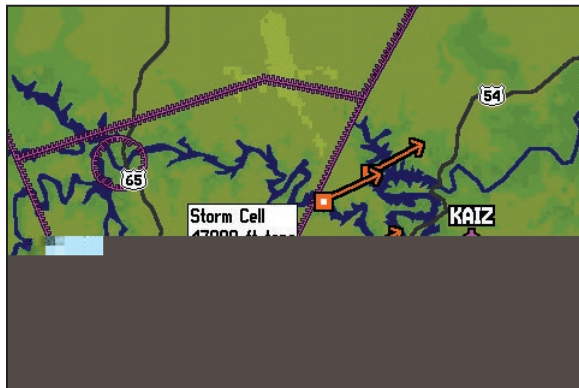



## Hurricanes

The Hurricanes feature shows the current position of a hurricane, tropical storm, or tropical depression, as well as its projected path (indicated by a red line). The darkened squares that appear along the red line display the projected locations received from the National Hurricane Center. The Center provides four forecasts at 12-hour intervals as well as a fifth forecast at a 24-hour interval.

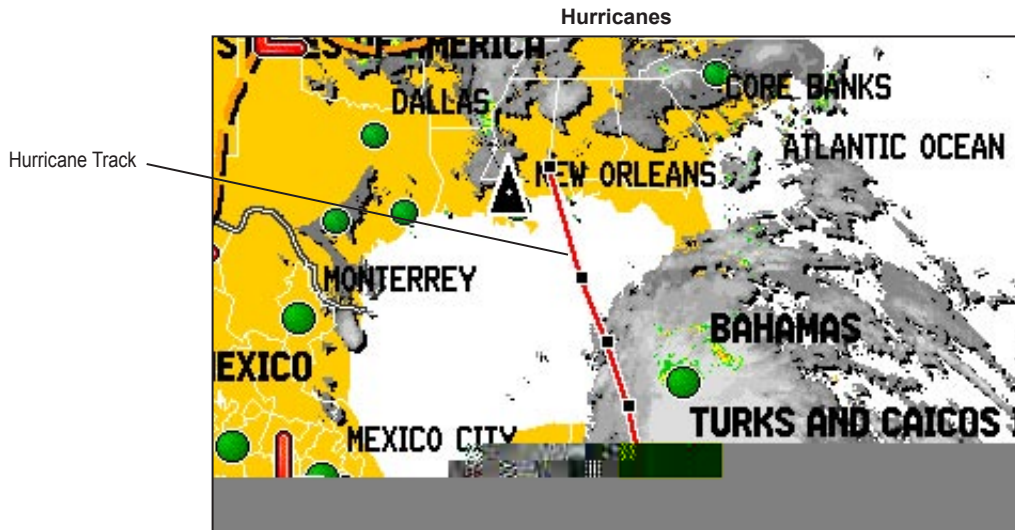

## Surface Winds

Marine and Automotive units shows Surface Winds with a wind barb. The wind barb is a circle with a tail. The circle points into the wind. Wind speed is indicated by the different combination of flags that are attached to the tail.

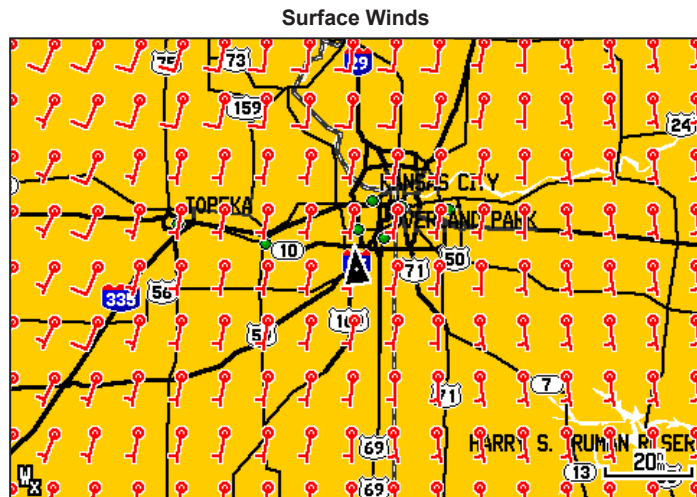
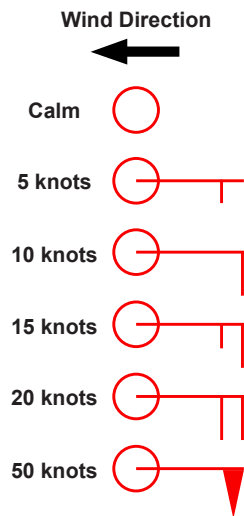

## Winds Aloft

Aviation units display winds aloft using wind barbs or a wind streamline depending on the zoom range of the map. Similar to Marine and Automotive units, the wind barbs indicate wind speed and direction. The wind streamline indicates wind direction with arrows.

Wind Barbs

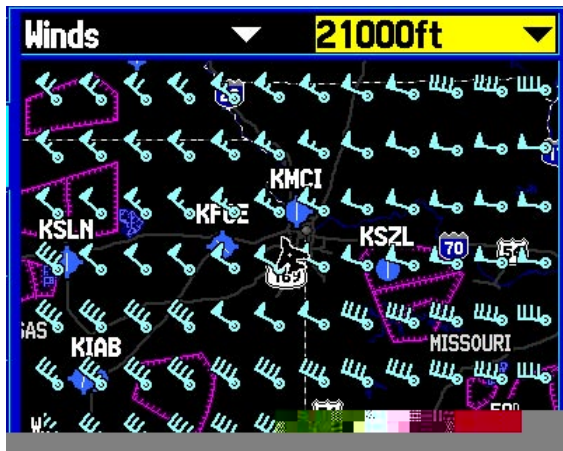

Wind Streamline

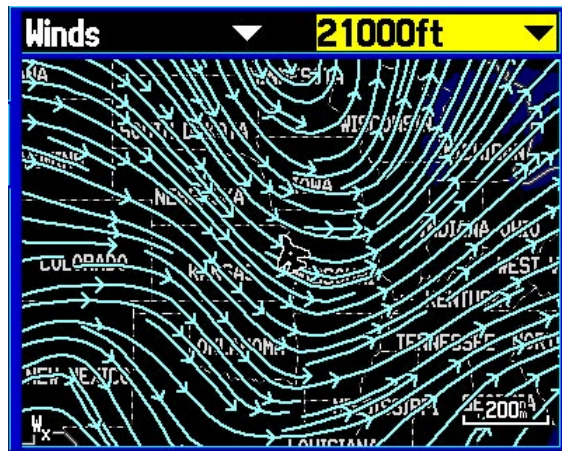

## Surface Pressure

This feature displays pressure isobars and pressure centers. The isobars connect points of equal pressure. Pressure readings can help determine weather and wind conditions in an area. High pressure areas are generally associated with fair weather. Low pressure areas are generally associated with clouds and the chance of precipitation. Isobars that are packed closely together show a strong pressure gradient. Strong pressure gradients are associated with areas of stronger winds. Pressure units can be displayed in Millibars (mb), Inches of Mercury (in), and Hectopascals (hPa).

Strong Pressure Gradient

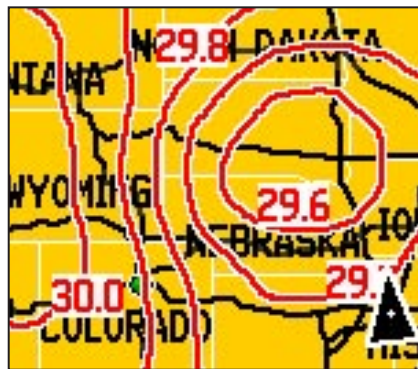

Pressure Isobars

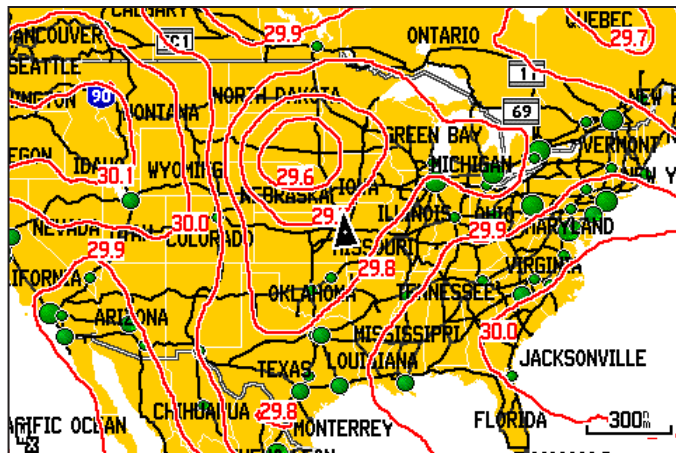

## Fronts

The Fronts feature displays lines indicating the leading edge of an air mass. This feature also displays pressure centers. Pressure centers are represented by a large Red “L” for low pressure centers or a large Blue “H” for high pressure centers. Pressure centers represent an area where pressure is measured to be either the highest or lowest relative to the surrounding area.

**L** Indicates a Low Pressure Center. A Low Pressure Center is an area where the measured pressure is lowest relative to the surrounding area. Moving away from a Low Pressure Center in any horizontal direction results in increased pressure. Winds flow counterclockwise around Low Pressure Centers in North America.

**H** Indicates a High Pressure Center. Similar to a Low Pressure Center, a High Pressure Center is an area where the measured pressure is highest relative to the surrounding area. Moving away from a High Pressure Center in any horizontal direction results in decreased pressure. Winds flow clockwise around Low Pressure Centers in North America.

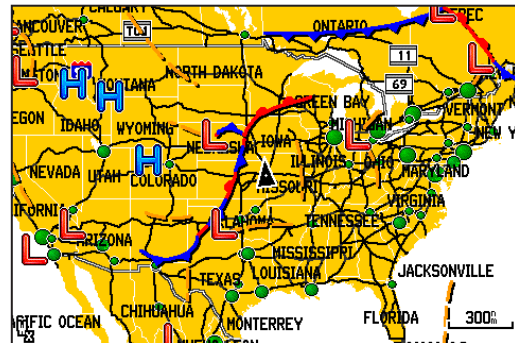
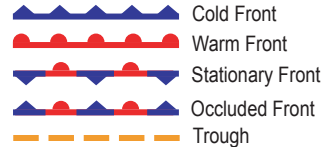

## Visibility

Visibility is the forecast maximum horizontal distance that can be seen at the surface. Contour lines on the Visibility feature show the forecasted change in surface visibility. In the example below, visibility ranges from 1 miles to 4.5 miles.

Visibility Contour Lines





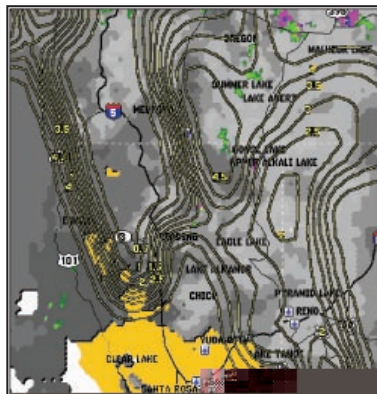

This image displays NEXRAD Radar, Satellite Mosaic, and Visibility. Displaying multiple features may help to provide a clearer picture of the weather conditions in the area.



## County Warnings

When the National Weather Service issues a weather warning for a county, the county is highlighted with the color corresponding to the warning. To view information about the warning, select the county with the map pointer. For more detail, press **ENTER**.

-  Tornado Warning
-  Severe Thunderstorm Warning
-  Flood Warning
-  Flash Flood Warning

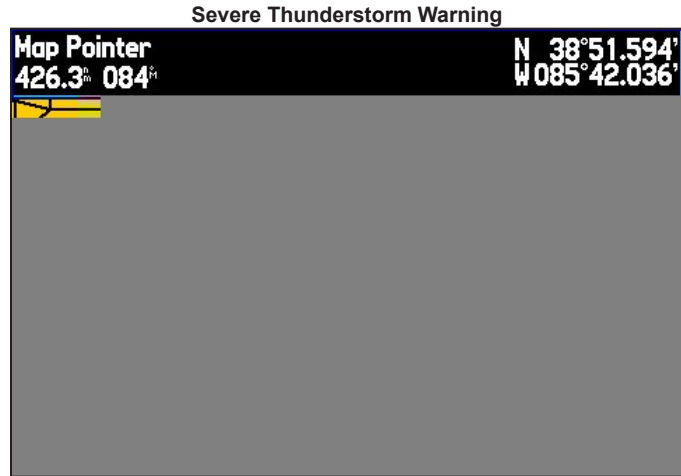

## Water Temperature

The Water Temperature feature displays the water's surface temperature. The temperature breaks are indicated by isotherm lines.

Water Temperature

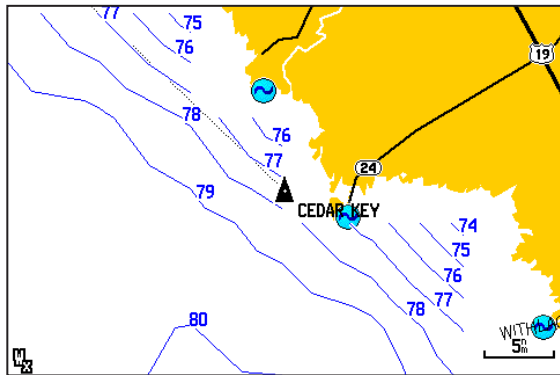

## Wave Period

The Wave Period feature provides the time (in seconds) between successive waves.

Wave Period

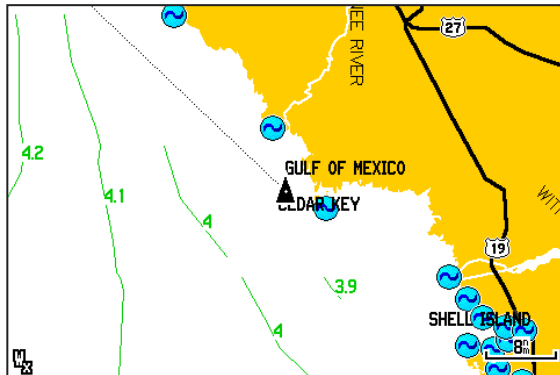



## Wave Direction

The Wave Direction feature shows the direction in which a wave is moving, as indicated by the direction of the red arrow.

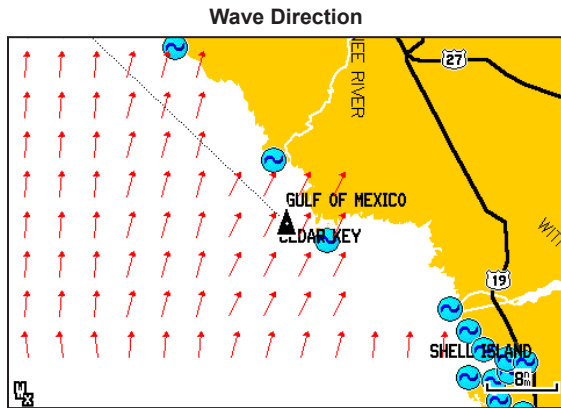

## Wave Height

The Wave Height feature displays wave heights. The wave heights for an area are separated by contour lines.

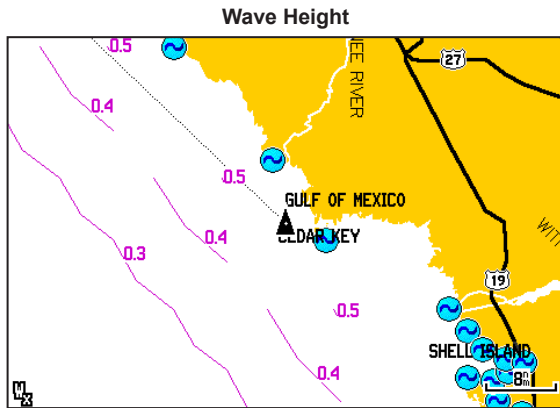

## Marine Warnings

When a Marine Warning is issued, the area for the warning is highlighted in red. To view information about the warning, select the warning area with the map pointer. To view more detailed information, press **ENTER**.

Marine Warnings

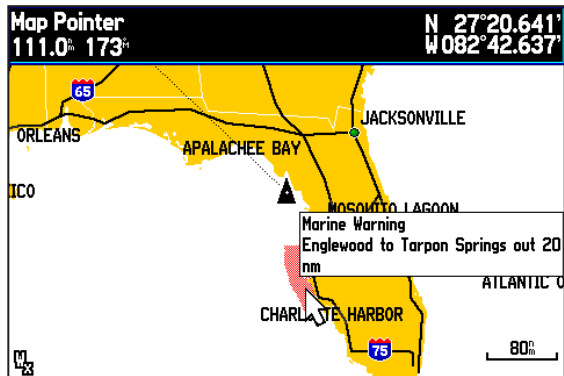

Marine Warning Detailed Information

**Marine Warning**

256 PM EDT FRI JUN 17 2005

...SPECIAL MARINE WARNING EXPIRED AT 300 PM EDT...

FOR THE FOLLOWING AREAS...  
WATERS FROM KEY WEST TO 20 NM WEST OF DRY TORTUGAS NORTH 20 NM AND SOUTH 60 NM.  
WEST END OF THE 7 MILE BRIDGE TO KEY WEST OUT 20 NM  
GULF SIDE OF THE LOWER KEYS OUT 20 NM  
FLORIDA BAY

NO FURTHER WATERSPOUTS HAVE BEEN REPORTED ALONG THE CLOUD LINE LOCATED FROM NEAR THE MARQUESAS KEYS...TO OVER AND JUST GULF SIDE OF THE LOWER KEYS...AND CONTINUING INTO THE FLORIDA BAY. THEREFORE THE SPECIAL MARINE WARNING HAS EXPIRED AT 300 PM. HOWEVER...SATELLITE AND DOPPLER RADAR IMAGERY INDICATE CONDITIONS ARE STILL FAVORABLE FOR WATERSPOUT FORMATION ALONG PORTIONS OF THIS CLOUD LINE.

Scroll Up Scroll Down OK

## Buoy Reports

Report readings are taken from buoys and coastal observation stations. These readings are used to determine Air Temperature, Dewpoint, Water Temperature, Tide, Wave Height and Period, Wind Direction and Speed, Visibility, and Barometric Pressure.

Buoy Selected with map pointer

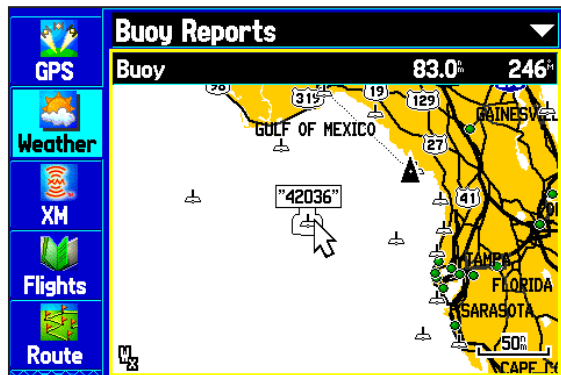



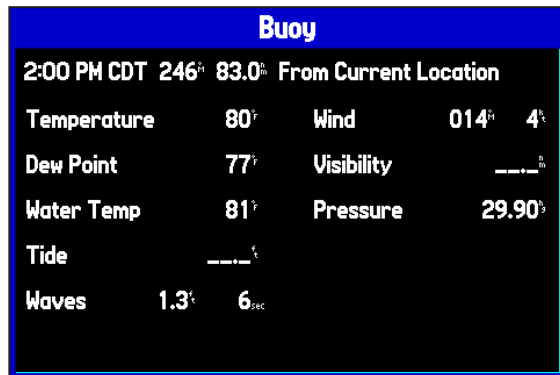

Buoy report detail



## METAR

Meteorological Aeronautical Reports (METARs) are an international code used for reporting weather observations. If METAR data is available for an airport, a color coded flag is shown next to the airport. To view the METAR data, select the flag with the map pointer. To view more detailed information, press **ENTER**.

-  VFR (ceiling greater than 3000 feet AGL and visibility greater than 5 miles)
-  Marginal VFR (ceiling 1000-3000 feet AGL and/or visibility 3-5 miles)
-  IFR (ceiling 500 to below 1000 feet AGL and/or visibility 1 mile to less than 3 miles)
-  Low IFR (ceiling below 500 feet AGL or visibility less than 1 mile)

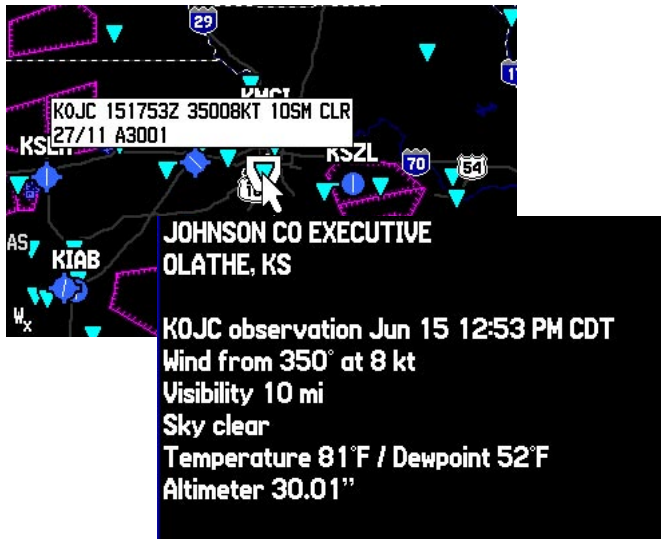

The image shows a map interface with various weather flags. A mouse cursor is pointing at a cyan flag for KOJC. A popup window displays the following information:

**KOJC 151753Z 35008KT 10SM CLR  
27/11 A3001**

**JOHNSON CO EXECUTIVE  
OLATHE, KS**

**KOJC observation Jun 15 12:53 PM CDT**  
**Wind from 350° at 8 kt**  
**Visibility 10 mi**  
**Sky clear**  
**Temperature 81°F / Dewpoint 52°F**  
**Altimeter 30.01"**

## AIRMET

An AIRMET (AIRman's METeoroological Information) can potentially affect all aircraft. This data can be especially helpful for pilots of light aircraft that have limited flight capability or instrumentation. An AIRMET must affect or be forecast to affect an area of at least 3,000 square miles at any one time. AIRMETs are routinely issued for 6 hour periods and are amended as necessary due to changing weather conditions or issuance/cancellation of a SIGMET. AIRMETs are displayed as a colored dashed line. To view AIRMET data, select the AIRMET using the map pointer. To view detailed information, press **ENTER**.

- AIRMET Sierra (IFR) (purple): Ceilings less than 1,000 feet and/or visibility less than 3 miles affecting over 50% of the area at one time. Extensive mountain obscuration
- AIRMET Tango (Turbulence) (orange): Moderate turbulence. Sustained surface winds of 30 knots or more at the surface.
- AIRMET Zulu (Icing) (blue): Moderate icing. Freezing levels.

AIRMET selected with map pointer



AIRMET detailed information

```

AIRMET TANGO UPDT 3 FOR TURB VALID UNTIL
152000

AIRMET TURB...NY OH PA WV VA LE LO ...UPDT
FROM MSS TO HNK TO LYH TO HMV TO HNN TO CVG TO
FWA TO DXO TO YYZ
TO MSS
OCNL MOD TURB BLW 080 DUE TO WLY WINDS. CONDS
CONTG BYD 20Z ENDG
00-02Z.
  
```

## SIGMET

A SIGMET (SIGNificant METeorological Forecast) advises of weather that is potentially hazardous to all aircraft. In the contiguous United States, items covered are: severe icing, severe or extreme turbulence, volcanic ash, dust storms, and sandstorms that lower visibility to less than three statute miles.

A Convective SIGMET is issued for: thunderstorms, isolated severe thunderstorms, embedded thunderstorms, hail at the surface, and tornadoes. A SIGMET is widespread. A SIGMET must affect or be forecast to affect an area of at least 3,000 square miles.

SIGMETs are displayed as a yellow dashed line. To view SIGMET data, select the SIGMET using the map pointer. To view detailed information, press **ENTER**.

SIGMET selected with map pointer

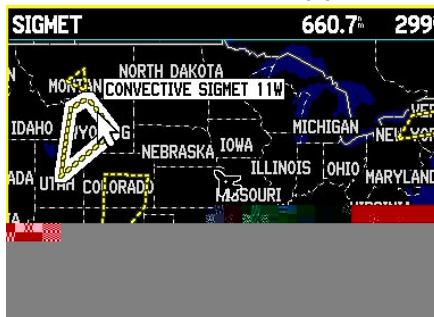

SIGMET detailed information

**CONVECTIVE SIGMET 11W**

VALID UNTIL 2255Z  
 CO WY UT  
 FROM 50S BIL-40SSE DDY-60E DTA-50NNE JAC-50S  
 BIL  
 DVLPG AREA TS MOV FROM 24020KT. TOPS TO  
 FL380.

OUTLOOK VALID 152255-160255

## TFR

Temporary Flight Restrictions or TFRs temporarily restrict all aircraft from entering the selected airspace unless a waiver has been issued. TFRs are routinely issued for occurrences such as sporting events, dignitary visits, military depots and forest fires. TFRs are represented as an area highlighted by Red (active) or Yellow (not yet active). To view information about the TFR, select it with the map pointer. To view more detailed information, press **ENTER**.

TFR selected with map pointer



TFR detailed information

**IA CVA 5/4845 graphic 1 of 4**  
**Sports Event TFR**  
**Surface to 16000ft MSL**  
**Active Jun 23 1:45 PM CDT**  
**Expires Jun 23 3:15 PM CDT**

## Echo Tops

Echo Tops are derived from NEXRAD radar and indicate the highest altitude at which precipitation is falling. Echo Tops at or above the altitude you select are displayed, in 5,000 foot increments up to 70,000 ft. Echo Tops can be helpful in determining the severity of thunderstorms. (higher = more intense)

Echo Tops for all altitudes

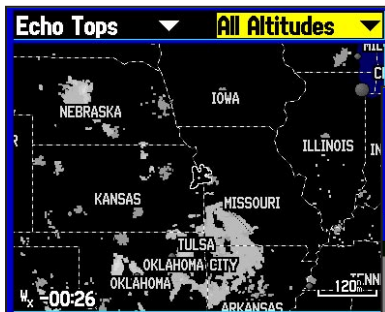

Echo Tops at 15,000 feet

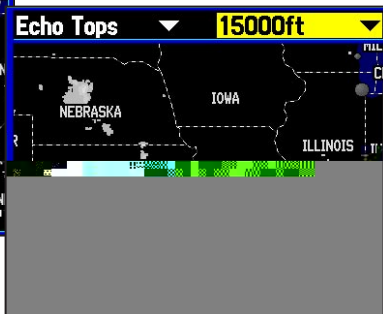

Echo Tops at 20,000 feet

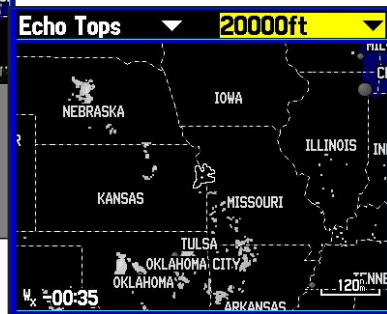



## Freezing Level

Shows contours for the lowest forecast altitude where icing conditions are likely to occur.

Freezing Level Contours

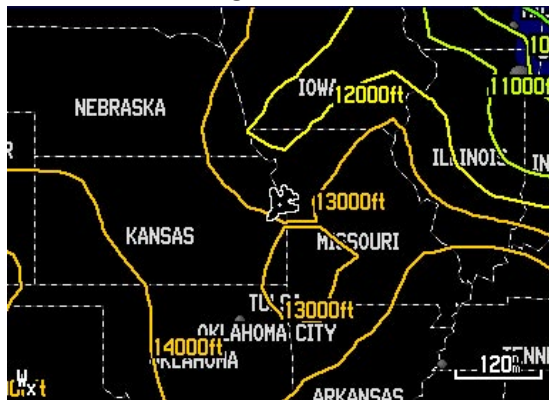

## Forecast

Forecast displays Fronts, High and Low Pressure Centers, and City Conditions. The forecast can be viewed in 12- hour increments for the next 48 hours.

Forecast map



Forecast Legend

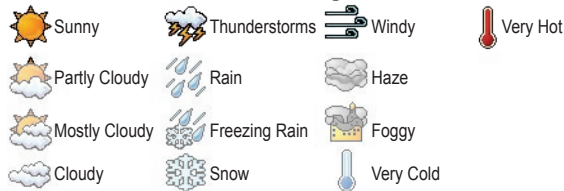

## TAF

Terminal Aerodrome Forecasts are issued by the National Weather Service for pilots. They include 24-hour forecasts on wind, visibility, expected weather conditions, and wind shear.

### Terminal Aerodrome Forecast

**WHEELER DOWNTOWN \***  
**KANSAS CITY, MO**

MMKC forecast issued Jun 16 6:28 AM CDT

From 7:00 AM CDT:  
 Wind from 080° at 5 kt  
 Visibility more than 6 mi  
 Clouds scattered at 10000 ft, overcast at 20000 ft

Changing at 11:00 AM CDT to:  
 Wind from 110° at 8 kt  
 Visibility more than 6 mi  
 Clouds scattered at 4000 ft, broken at 25000 ft

Changing at 6:00 PM CDT to:  
 Wind from 100° at 5 kt  
 Visibility more than 6 mi  
 Scattered clouds at 25000 ft

Forecast valid until Jun 17 7:00 AM CDT

From K34

## XM Radio

The XM Audio feature requires a subscription to XM Radio. Channels can be scanned by category and saved to a Favorites list. The XM audio output can be turned on and off.

**XM Audio**

Category

Channel list

|                |                  |
|----------------|------------------|
| <b>Rock</b>    |                  |
| 45 XM Cafe     | Bluestring       |
| 46 Top Tracks  | Crosby Stills Na |
| 47 Ethel       | Phantom Planet   |
| ▶ 48 Squizz xL | Nickelback       |
| 50 The Loft    | Del Amitri       |

Current song

**Nickelback**  
 How You Remind M  
 48 Squizz xL

## APPENDIX

### Specifications

#### Physical Specifications

**Size:** 83mm diameter x 27.5mm height

**Weight:** 224g (7.9 oz)

**Temp. Range:** -40F to +185F (-40C to +85C)

**Case:** fully sealed high-impact plastic with die-cast zinc base

**Waterproof:** -1 meter submersion for 30 minutes IEC 60529 IPX7

**Mount Thread Size:** M3 x 0.5

**Cable:** Braided shield, 5 conductor 28 AWG, Right Angle Male Mini-B connector

#### Power

**Source:** 4.5-5.5 Vdc

**Usage:** 2.5 watts max

#### Performance

**Dynamics:** 999 knots, 6g

| <b>Feature</b>      | <b>Data Broadcast Frequency</b> |
|---------------------|---------------------------------|
| NEXRAD Radar        | 5 mins                          |
| Satellite Mosaic    | 15 mins                         |
| Storm Cells         | 1.25 mins                       |
| Lightning           | 5 mins                          |
| Surface Winds       | 12 mins                         |
| Surface Pressure    | 12 mins                         |
| Hurricane Track     | 12 mins                         |
| Visibility Forecast | 12 mins                         |
| Fronts              | 12 mins                         |
| Water Temperature   | 12 mins                         |
| Wave Height         | 12 mins                         |
| Wave Period         | 12 mins                         |
| Wave Direction      | 12 mins                         |
| Buoy Reports        | 12 mins                         |
| City Forecast       | 12 mins                         |
| County Warnings     | 5 mins                          |

| <b>Feature</b>  | <b>Data Broadcast Frequency</b> |
|-----------------|---------------------------------|
| Marine Warnings | 20 mins                         |
| METAR           | 12 mins                         |
| AIRMET          | 12 mins                         |
| SIGMET          | 12 mins                         |
| Echo Tops       | 7.5 mins                        |
| Winds Aloft     | 12 mins                         |
| TFR             | 12 mins                         |
| TAF             | 12 mins                         |
| Freezing Level  | 12 mins                         |

## NEXRAD Overview

### NEXRAD Description

NEXRAD Radar is a Doppler radar system that has greatly improved the detection of meteorological events such as thunderstorms, tornadoes, and hurricanes. An extensive network of NEXRAD stations provides almost complete radar coverage of the continental United States, Alaska, and Hawaii. The range of each NEXRAD is 124 nautical miles.

### NEXRAD Abnormalities

There are possible abnormalities regarding displayed NEXRAD images. Some, but not all, of those include:

- Ground clutter
- Strokes and spurious radar data
- Sun strokes, when the radar antenna points directly at the sun
- Military aircraft deploy metallic dust (chaff) which can cause alterations in radar scans
- Interference from buildings or mountains, which may cause shadows

### NEXRAD Limitations

Certain limitations exist regarding the NEXRAD radar displays. Some, but not all, are listed for the user's awareness:

- NEXRAD base reflectivity does not provide sufficient information to determine cloud layers or precipitation characteristics (hail vs. rain).
- NEXRAD base reflectivity is sampled at the minimum antenna elevation angle. An individual NEXRAD site cannot depict high altitude storms at close ranges, and has no information about storms directly over the site.

## NEXRAD Intensity

Colors are used to identify the different NEXRAD echo intensities (reflectivity) measured in dBZ. (decibels of Z).

“Reflectivity” (designated by the letter Z) is the amount of transmitted power returned to the radar receiver. The dBZ values increase as returned signal strength increases.

Precipitation intensity is displayed using colors represented by the dBZ values listed in the table to the right.



The information presented in this manual is not meant to be comprehensive. The NOAA web site contains complete and detailed information regarding NEXRAD weather radar operation and theory. You can visit them at [www.noaa.gov](http://www.noaa.gov).

| Display Rain | Display Snow | dBZ  | Rain (inches/hour) | Snow (inches/hour) | Remarks          |                  |
|--------------|--------------|------|--------------------|--------------------|------------------|------------------|
|              |              |      |                    |                    | Rain             | Snow             |
|              |              | <-10 | .00"               | .00"               |                  |                  |
|              |              | -10  | .00"               | .00"               |                  |                  |
|              |              | -5   | .00"               | trace              |                  |                  |
|              |              | 0    | .00"               | trace - .05"       |                  | Very Light       |
|              |              | 5    | .00"               | trace - .10"       |                  | Light            |
|              |              | 10   | 0" - trace         | .01"               | Light            | Light            |
|              |              | 15   | .01"               | .1 - .2"           | Light            | Light            |
|              |              | 20   | .02"               | .2 - .3"           | Light            | Light            |
|              |              | 25   | .05"               | .3 - .5"           | Light            | Light - Moderate |
|              |              | 30   | .09"               | .5 - .7"           | Light - Moderate | Moderate         |
|              |              | 35   | .24"               | .7 - 1.0"          | Moderate         | Heavy            |
|              |              | 40   | .48"               | 1" + or sleet      | Heavy            | Heavy            |
|              |              | 45   | 1.25"              | 1" + or sleet      | Heavy            | Heavy            |
|              |              | 50   | 2.5"               | sleet              | Intense          |                  |
|              |              | 55   | 5.7"               | sleet              | Extreme          |                  |
|              |              | 55+  | 12.7"              |                    | Extreme          |                  |

## FCC Compliance



The GXM 30 complies with Part 15 of the FCC interference limits for Class B digital devices FOR HOME OR OFFICE USE. These limits are designed to provide more reasonable protection against harmful interference in a residential installation, and are more stringent than “outdoor” requirements.

Operation of this device is subject to the following conditions:

(1) This device may not cause harmful interference, and (2) this device must accept any interference received, including interference that may cause undesired operation.

This equipment generates, uses, and can radiate radio frequency energy and may cause harmful interference to radio communications if not installed and used in accordance with the instructions. However, there is no guarantee that interference will not occur in a particular installation. If this equipment does cause harmful interference to radio or

television reception, which can be determined by turning the equipment off and on, the user is encouraged to try to correct the interference by one of the following measures:

- Reorient or relocate the receiving antenna.
- Increase the separation between the equipment and the receiver.
- Connect the equipment into an outlet on a circuit different from that to which the receiver is connected.
- Consult the dealer or an experienced radio/TV technician for help.

The GXM 30 does not contain any user-serviceable parts. Repairs should only be made by an authorized Garmin service center. Unauthorized repairs or modifications could result in permanent damage to the equipment, and void your warranty and your authority to operate this device under Part 15 regulations.

## Limited Warranty

This Garmin product is warranted to be free from defects in materials or workmanship for one year from the date of purchase. Within this period, Garmin will at its sole option repair or replace any components that fail in normal use. Such repairs or replacement will be made at no charge to the customer for parts or labor, provided that the customer shall be responsible for any transportation cost. This warranty does not cover failures due to abuse, misuse, accident or unauthorized alteration or repairs.

THE WARRANTIES AND REMEDIES CONTAINED HEREIN ARE EXCLUSIVE AND IN LIEU OF ALL OTHER WARRANTIES EXPRESS OR IMPLIED OR STATUTORY, INCLUDING ANY LIABILITY ARISING UNDER ANY WARRANTY OF MERCHANTABILITY OR FITNESS FOR A PARTICULAR PURPOSE, STATUTORY OR OTHERWISE. THIS WARRANTY GIVES YOU SPECIFIC LEGAL RIGHTS, WHICH MAY VARY FROM STATE TO STATE.

IN NO EVENT SHALL GARMIN BE LIABLE FOR ANY INCIDENTAL, SPECIAL, INDIRECT OR CONSEQUENTIAL DAMAGES, WHETHER RESULTING FROM THE USE, MISUSE, OR INABILITY TO USE THIS PRODUCT OR FROM DEFECTS IN THE PRODUCT. Some states do not allow the exclusion of incidental or consequential damages, so the above limitations may not apply to you.

Garmin retains the exclusive right to repair or replace the unit or software or offer a full refund of the purchase price at its sole discretion. SUCH REMEDY SHALL BE YOUR SOLE AND EXCLUSIVE REMEDY FOR ANY BREACH OF WARRANTY.

To obtain warranty service, contact your local Garmin authorized dealer or call Garmin Product Support for shipping instructions and an RMA tracking number. The unit should be securely packed with the tracking number clearly written on the outside of the package. The unit should then be sent, freight charges prepaid, to any Garmin warranty service station. A copy of the original sales receipt is required as the proof of purchase for warranty repairs.



Garmin International, Inc.  
1200 E 151st Street, Olathe, Kansas 66062 U.S.A.  
Tel. 913/397.8200  
Fax. 913/397.8282

Garmin (Europe) Ltd.  
Unit 5, The Quadrangle, Abbey Park Industrial Estate, Romsey, SO51  
9DL U.K.  
Tel. 44/0870.8501241  
Fax 44/0870.8501251

**Online Auction Purchases:** Products sold through online auctions are not eligible for rebates or other special offers from Garmin. Online auction confirmations are not accepted for warranty verification. To obtain warranty service, an original or copy of the sales receipt from the original retailer is required. Garmin will not replace missing components from any package purchased through an online auction.

**International Purchases:** A separate warranty is provided by international distributors for units purchased outside the United States. This warranty is provided by the local in-country distributor and this distributor provides local service for your unit. Distributor warranties are only valid in the area of intended distribution. Units purchased in the United States or Canada must be returned to the Garmin service center in the United Kingdom, the United States, Canada, or Taiwan for service.

The Garmin GXM 30 has no user-serviceable parts. Should you ever encounter a problem with your unit, please take it to an authorized Garmin dealer for repairs.

The GXM 30 is fastened shut with screws. Any attempt to open the case to change or modify the unit in any way will void your warranty and may result in permanent damage to the equipment.

## Software License Agreement

BY USING THE GXM 30, YOU AGREE TO BE BOUND BY THE TERMS AND CONDITIONS OF THE FOLLOWING SOFTWARE LICENSE AGREEMENT. PLEASE READ THIS AGREEMENT CAREFULLY.

Garmin grants you a limited license to use the software embedded in this device (the “Software”) in binary executable form in the normal operation of the product. Title, ownership rights, and intellectual property rights in and to the Software remain in Garmin.

You acknowledge that the Software is the property of Garmin and is protected under the United States of America copyright laws and international copyright treaties. You further acknowledge that the structure, organization, and code of the Software are valuable trade secrets of Garmin and that the Software in source code form remains a valuable trade secret of Garmin. You agree not to decompile, disassemble, modify, reverse assemble, reverse engineer, or reduce to human readable form the Software or any part thereof or create any derivative works based on the Software. You agree not to export or re-export the Software to any country in violation of the export control laws of the United States of America.

## XM Satellite Radio Service Agreement

XM Satellite Radio Inc.

Hardware and required monthly subscription sold separately. Subscription fee is consumer only. Other fees and taxes, including a one-time activation fee may apply. All programming fees and weather data subject to change. XM WX weather data displays and individual product availability vary by hardware equipment. Reception of the XM signal may vary depending on location. Subscriptions subject to Customer Agreement included with the XM Welcome Kit and available at [xmradio.com](http://xmradio.com). Available only in the 48 contiguous United States. XM WX is a trademark of XM Satellite Radio Inc.

## Weather Data Warranty

THE SOFTWARE PRODUCT IS PROVIDED “AS IS.” ALL OTHER WARRANTIES, EXPRESSED OR IMPLIED, INCLUDING ANY WARRANTY OF MERCHANTABILITY OR FITNESS FOR A PARTICULAR PURPOSE OR OF NON-INFRINGEMENT ARE HEREBY EXCLUDED.

### USER SAFETY

If you use XM Services it is your responsibility to exercise prudent discretion and observe all safety measures required by law and your own common sense. You assume the entire risk related to your use of the Services. XM and Garmin assume no responsibility for accidents resulting from or associated with use of the Services. Your Radio Service includes traffic and weather information, and you acknowledge that such information is not for “safety for life”, but is merely supplemental and advisory in nature, and therefore cannot be relied upon as safety-critical in connection with any aircraft, sea craft or automobile usage. This information is provided “as is” and XM and Garmin disclaim any and all warranties, express and implied, with respect thereto or the transmission or reception thereof. XM and Garmin further do not warrant the accuracy, reliability, completeness or timeliness of the traffic and weather information disclosed on the Radio Service. In no event will XM and Garmin, their data suppliers, service providers, marketing/distribution, software or Internet partners or hardware manufacturers be liable to you or to any third party for any direct, indirect, incidental, consequential, special, exemplary or

punitive damages or lost profits resulting from use of or interruptions in the transmission or reception of the Services.

### LIMITS ON OUR RESPONSIBILITY

#### a) DISCLAIMERS.

EXCEPT AS EXPRESSLY PROVIDED HEREIN, WE MAKE NO WARRANTY OR REPRESENTATION, EITHER EXPRESS OR IMPLIED, REGARDING THE RADIO SERVICE. YOUR USE OF THE SERVICE IS AT YOUR SOLE RISK. THE CONTENT AND FUNCTIONALITY OF THE SERVICE IS PROVIDED “AS IS” WITHOUT ANY WARRANTY OF ANY KIND, EXPRESS OR IMPLIED. ALL SUCH WARRANTIES OR REPRESENTATIONS (INCLUDING, WITHOUT LIMITATION, THE IMPLIED WARRANTIES OF MERCHANTABILITY, FITNESS FOR A PARTICULAR PURPOSE, TITLE AND NON-INFRINGEMENT) ARE HEREBY DISCLAIMED.

b) LIMITATIONS OF LIABILITY.

WE ARE NOT RESPONSIBLE FOR ANY SPECIAL, INCIDENTAL, OR CONSEQUENTIAL DAMAGES OR LOSSES RELATING TO THE USE OF THE RADIO SERVICE, WHETHER BASED ON NEGLIGENCE OR OTHERWISE. OUR TOTAL LIABILITY TO YOU AND ANY OTHER PERSONS RECEIVING OUR SERVICES, REGARDLESS OF THE CAUSE, WILL IN NO EVENT EXCEED THE AMOUNTS THAT YOU HAVE PAID TO US FOR THE SERVICE THAT YOU RECEIVED DURING THE SIX (6) MONTH PERIOD IMMEDIATELY PRIOR TO THE SPECIFIC EVENT THAT GAVE RISE TO THE APPLICABLE DAMAGE OR LOSS. THIS ALLOCATION OF RISK IS REFLECTED IN OUR PRICES. YOU MAY HAVE GREATER RIGHTS THAN DESCRIBED ABOVE UNDER YOUR STATE'S LAWS

a. Under 10 U.S.C. 456, no civil action may be brought against the United States on the basis of the content of a navigational aid prepared or disseminated by either the former Defense Mapping Agency (DMA), National Imagery and Mapping Agency (NIMA), or the National Geospatial-Intelligence Agency (NGA).

b. The DAFIF™ product is provided “as is,” and no warranty, express or implied, including, but not limited to the implied warranties of merchantability and fitness for particular purpose or arising by statute

or otherwise in law or from a course of dealing or usage in trade, is made by NGA as to the accuracy and functioning of the product.

c. Neither NGA nor its personnel will be liable for any claims, losses, or damages arising from or connected with the use of this product. The user agrees to hold harmless the United States National Geospatial-Intelligence Agency. The user's sole and exclusive remedy is to stop using the DAFIF product.

This product was developed using DAFIF™, a product of the National Geospatial-Intelligence Agency.

## TFR Data

Temporary Flight Restriction (TFR) data is provided by the FAA and may not be updated outside of normal business hours. Confirm data currency through alternate sources and contact your local FSS for interpretation of TFR data. This product has not been endorsed or otherwise approved by the National Geospatial-Intelligence Agency, or the United States Department of Defense (10 U.S.C. 425)

## INDEX

### A

- Add Features 4
- AIRMET 22
- Audio Submenu Tab 3

### B

- Buoy Reports 20

### C

- Cleaning 1
- Cleaning the unit 1
- Cloud Cover 7
- coastal observation stations 20
- Cold Front 14
- Connecting 2
- Connecting the GXM 30 2
- Contact XM Satellite Radio 3
- County Warnings 16

### D

- Displaying Weather Information 5

### E

- Echo Tops 25

### F

- Favorites list 27
- FCC Compliance 32
- Feature Broadcast Rates 29
- Flash Flood Warning 16
- Flood Warning 16
- Forecast 26
- Freezing Level 26
- Fronts 14
- Fronts map 14

### G

- Ground Clutter 30

### H

- High Pressure Center 14, 26
- Hurricanes 10

### I

- icing 26
- IFR 21
- Interference 30
- Introduction iii
- Isobars 13

### L

- Lightning 8
- Lightning bolt icons 8
- Limited Warranty 33
- Low Pressure Center 14, 26

### M

- Magnetic Base 1
- Marine Warnings 19
- METAR 21
- Mounting Holes 1

### N

- National Weather Service 16
- NEXRAD 6
- NEXRAD Abnormalities 30
- NEXRAD Colors 31

- NEXRAD Description 30
- NEXRAD Intensity 31
- NEXRAD Legend 6
- NEXRAD Limitations 30
- NEXRAD Overview 30
- NEXRAD Radar 6

### O

- Occluded Front 14

### P

- Physical Specifications 28
- Precipitation 6
- Preface iii
- Pressure Center 14
- Pressure Gradient 13
- Pressure Isobars 13
- projected path 9

### R

- Radio ID 3
- Radio ID - Weather 3

**S**

Satellite Mosaic 7  
Saving the Service Package 4  
Serial Number iv  
SERVICING 1  
SERVICING YOUR UNIT 1  
Set up the XM Account 3  
Severe Thunderstorm Warning 16  
SIGMET 23  
Software License Agreement 35  
Specifications 28  
Stationary Front 14  
Storage 1  
Storm Cells 9  
Strobes 30  
Strong Pressure Gradient 13  
Subscribing to XM 3  
Sun strobes 30  
Surface Pressure 13  
Surface Winds 11

**T**

TAF 27  
Temporary Flight Restriction 24  
Terminal Aerodrome Forecast 27  
TFR 24  
Time Stamp 6  
Tornado Warning 16  
Tropical depression 10  
Tropical storm 10  
Trough 14

**U**

UNIT CARE 1  
Unit Overview 1  
USB Connector 1  
USB port 2

**V**

VFR 21  
Visibility 15

**W**

Warm Front 14  
Warranty 33  
Water Temperature 17  
Wave Direction 18  
Wave Height 18  
Wave Period 17  
Weather data 5  
Weather Legend 6  
Weather Maps  
    Fronts 14  
Winds Aloft 12  
Wind barb 11  
Wind Barbs 12  
Wind Streamline 12

**X**

XM Audio 27  
XM Package 4  
XM Radio 4  
XM Radio ID iv  
XM Weather/Radio  
    800 number 3  
XM WX Weather 4



**For the latest free software updates (excluding map data) throughout the life of your  
Garmin products, visit the Garmin Web site at [www.garmin.com](http://www.garmin.com).**



© Copyright 2005 Garmin Ltd. or its subsidiaries

Garmin International, Inc.  
1200 East 151<sup>st</sup> Street, Olathe, Kansas 66062, U.S.A.

Garmin (Europe) Ltd.  
Unit 5, The Quadrangle, Abbey Park Industrial Estate, Romsey, SO51 9DL, U.K.

Garmin Corporation  
No. 68, Jangshu 2<sup>nd</sup> Road, Shijr, Taipei County, Taiwan

[www.garmin.com](http://www.garmin.com)

Part Number 190-00535-00 Rev. B