

FM Stereo FM/AM Receiver

Operating Instructions

STR-DB798

WARNING

To prevent fire or shock hazard, do not expose the unit to rain or moisture.

To prevent fire, do not cover the ventilation of the apparatus with news papers, table-cloths, curtains, etc. And don't place lighted candles on the apparatus.

To prevent fire or shock hazard, do not place objects filled with liquids, such as vases, on the apparatus.

Do not install the appliance in a confined space, such as a bookcase or built-in cabinet.



Don't throw away batteries with general house waste; dispose of them correctly as chemical waste.



Disposal of Old Electrical & Electronic Equipment (Applicable in the European Union and other European countries with separate collection systems)

This symbol on the product or on its packaging indicates that this product shall not be treated as household waste. Instead it shall be handed over to the applicable collection point for the recycling of electrical and electronic equipment. By ensuring this product is disposed of correctly, you will help prevent potential negative consequences for the environment and human health, which could otherwise be caused by inappropriate waste handling of this product. The recycling of materials will help to conserve natural resources. For more detailed information about recycling of this product, please contact your local city office, your household waste disposal service or the shop where you purchased the product.

About This Manual

- The instructions in this manual are for model STR-DB798. Check your model number by looking at the lower right corner of the front panel. In this manual, the models of area code CEL is used for illustration purposes unless stated otherwise.
- The instructions in this manual describe the controls on the receiver. You can also use the controls on the supplied remote if they have the same or similar names as those on the receiver. For details on the use of your remote, see pages 48–56.

About area codes

The area code of the receiver you purchased is shown on the lower portion of the rear panel (see the illustration below).

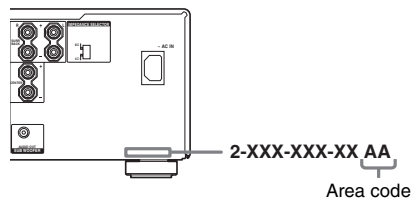

Any differences in operation, according to the area code, are clearly indicated in the text, for example, "Models of area code AA only".

This receiver incorporates Dolby* Digital and Pro Logic Surround and the DTS** Digital Surround System.

* Manufactured under license from Dolby Laboratories.
"Dolby", "Pro Logic", "Surround EX", and the double-D symbol are trademarks of Dolby Laboratories.

**"DTS", "DTS-ES", "Neo:6" and "DTS 96/24" are trademarks of Digital Theater Systems, Inc.

Note for the supplied remote

For RM-AAP002

The 12, AUX and SOURCE buttons on the remote are not available for receiver operation.

Table of Contents

Getting Started

- 1: Check how to hookup your components 4
 - 1a: Connecting components with digital audio output jacks 6
 - 1b: Connecting components with multi channel output jacks..... 9
 - 1c: Connecting components with only analog audio jacks 11
- 2: Connecting the antennas 13
- 3: Connecting speakers 14
- 4: Connecting the AC power cord 16
- 5: Setting up the speakers 17
- 6: Adjusting the speaker levels and balance 20
 - TEST TONE

Amplifier Operation

- Selecting the component 22
- Listening to multi channel sound 23
 - MULTI CH IN
- Listening to FM/AM radio 23
- Storing FM stations automatically 24
 - AUTOBETICAL
(Models of area code CEL, CEK only)
- Presetting radio stations 25
- Using the Radio Data System (RDS)..... 26
 - (Models of area code CEL, CEK only)
- Changing the display 27
- About the indications in the display..... 28

Enjoying Surround Sound

- Using only the front speakers 30
- Enjoying higher fidelity sound..... 31
 - AUTO FORMAT DIRECT
- Selecting a sound field 33
- Selecting the surround back decoding mode 35
 - SURR BACK DECODING

Advanced Adjustments and Settings

- Assigning the component video input..... 37
 - COMPONENT VIDEO INPUT ASSIGN
- Switching the audio input mode for digital components 37
 - INPUT MODE
- Customizing sound fields 38
- Adjusting the equalizer 39
- Advanced settings..... 40

Other Operations

- Naming preset stations and inputs 44
- Changing the command mode of the receiver 45
- Using the Sleep Timer 45
- Selecting the speaker system 46
- Recording..... 46

Operations Using the Remote RM-AAP002

- Before you use your remote..... 48
- Remote button description..... 48
- Selecting the command mode of the remote..... 53
- Programming the remote 53

Additional Information

- Precautions..... 57
- Troubleshooting..... 58
- Specifications..... 61
- List of button locations and reference pages..... 63
- Index Back cover

1: Check how to hookup your components

Steps 1a through 1c beginning on page 6 describe how to hook up your components to this receiver. Before you begin, refer to “Connectable components” below for the pages which describe how to connect each component.

After hooking up all your components, proceed to “2: Connecting the antennas” (page 13).

Connectable components

Component to be connected	Page
DVD player	
With digital audio output ^{a)}	6–7
With multi channel audio output ^{b)}	9–10
With analog audio output only ^{c)}	6–7
TV monitor	
With component video input ^{d)}	7 or 10
With S-Video or composite video input only	12
Satellite tuner	
With digital audio output ^{a)}	6–7
With analog audio output only ^{c)}	6–7
Super Audio CD/CD player	
With digital audio output ^{a)}	8
With multi channel audio output ^{b)}	9
With analog audio output only ^{c)}	11
MD/Tape deck	
With digital audio output ^{a)}	8
With analog audio output only ^{c)}	11
Analog disc turntable	11
Multi channel decoder	9
VCR	12
Video game player	
With digital audio output ^{a)}	6–7
With analog audio output only ^{c)}	6–7

^{a)} Model with a DIGITAL OPTICAL OUTPUT or DIGITAL COAXIAL OUTPUT jack, etc.

^{b)} Model with a MULTI CH OUTPUT jacks, etc. This connection is used to output the audio decoded by the component’s internal multi-channel decoder through this receiver.

^{c)} Model equipped only with AUDIO OUT L/R jacks, etc.

^{d)} Model with component video (Y, Pb/Cb/B-Y, Pr/Cr/R-Y) input jacks.

Required cords

The hookup diagrams on the subsequent pages assume the use of the following optional connection cords (**A** to **H**) (not supplied).

A Audio cord

White (L)
Red (R)



B Audio/video cord

Yellow (video)
White (L/audio)
Red (R/audio)



C Video cord

Yellow



D S-video cord



E Optical digital cord



F Coaxial digital cord



G Monaural audio cord

Black



Tip

Audio cord **A** can be torn into two monaural audio cords **G**.

H Component video cord

Green
Blue
Red



Notes

- Turn off the power to all components before making any connections.
- Be sure to make connections firmly to avoid hum and noise.
- When connecting an audio/video cord, be sure to match the color-coded pins to the appropriate jacks on the components: yellow (video) to yellow; white (left, audio) to white; and red (right, audio) to red.
- When connecting optical digital cords, insert the cord plugs straight in until they click into place.
- Do not bend or tie optical digital cords.

1a: Connecting components with digital audio output jacks

Hooking up a DVD player, TV monitor, satellite tuner or video game player

For details on the required cords (A–H), see page 5.

1 Connect the audio jacks.

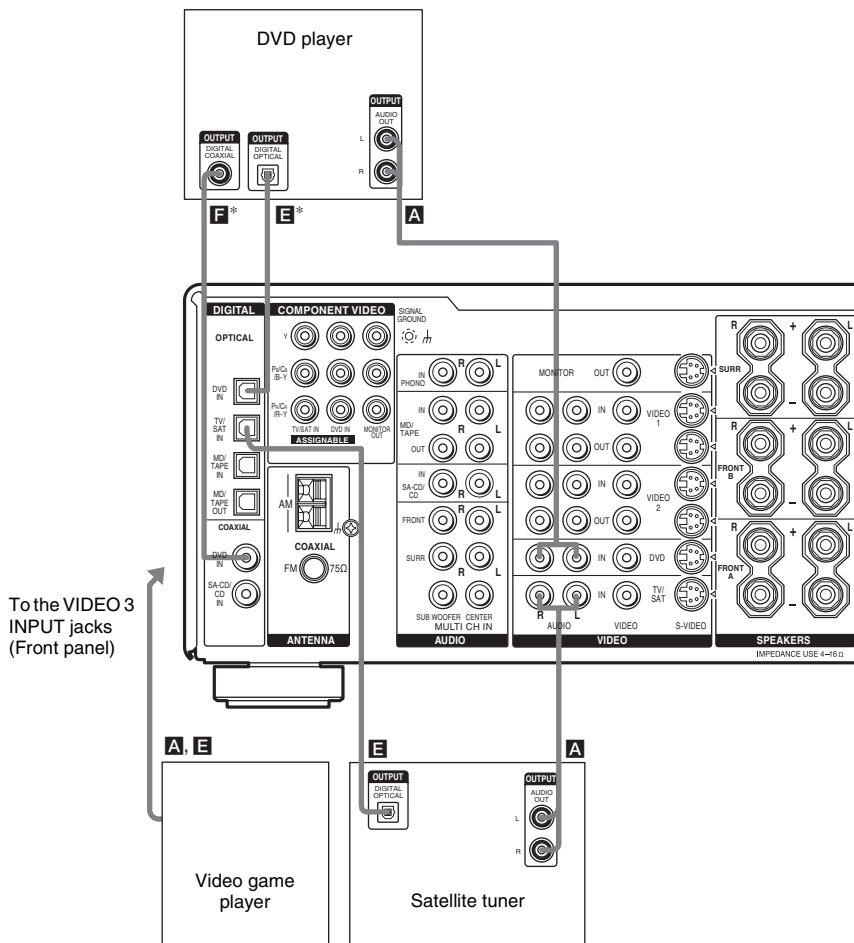

* Connect to either the COAXIAL DVD IN or the OPTICAL DVD IN jack. We recommend making connections to the COAXIAL DVD IN jack.

Note

You can also listen to the sound of your TV by connecting your TV's audio output jacks to the TV/SAT AUDIO IN jacks on the receiver. In this case, do not connect the TV's video output jack to the TV/SAT VIDEO IN jack on the receiver.

2 Connect the video jacks.

The following illustration shows how to connect a TV or satellite tuner and a DVD player with COMPONENT VIDEO (Y, P_B/C_B/B-Y, P_R/C_R/R-Y) output jacks. Connecting a TV with component video input jacks allows you to enjoy higher quality video.

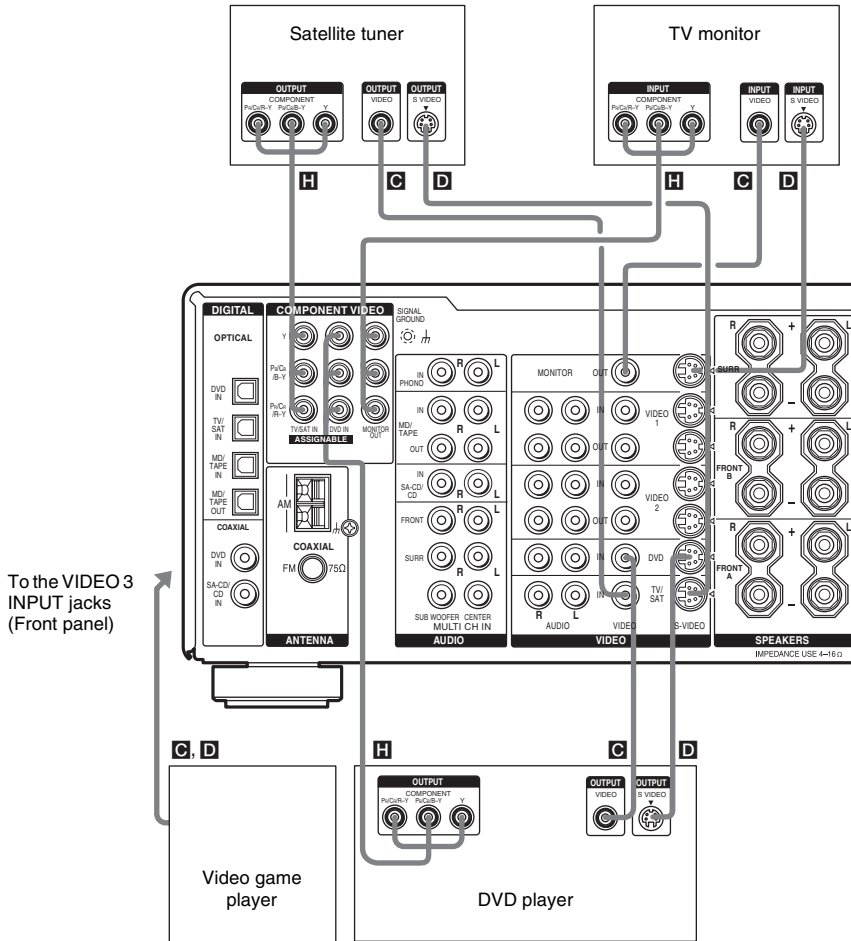

Tips

- When using the S-video jacks instead of the video jacks, your monitor must also be connected via an S-video jack. S-video signals are on a separate bus from the video signals and will not be output through the video jacks.
- On this receiver, standard video signals can be converted to S-video signals and this upconverted video signals can only be output from the MONITOR S-VIDEO OUT jack.

Hooking up an MD/Tape deck or a Super Audio CD/CD player

For details on the required cords (**A**–**H**), see page 5.

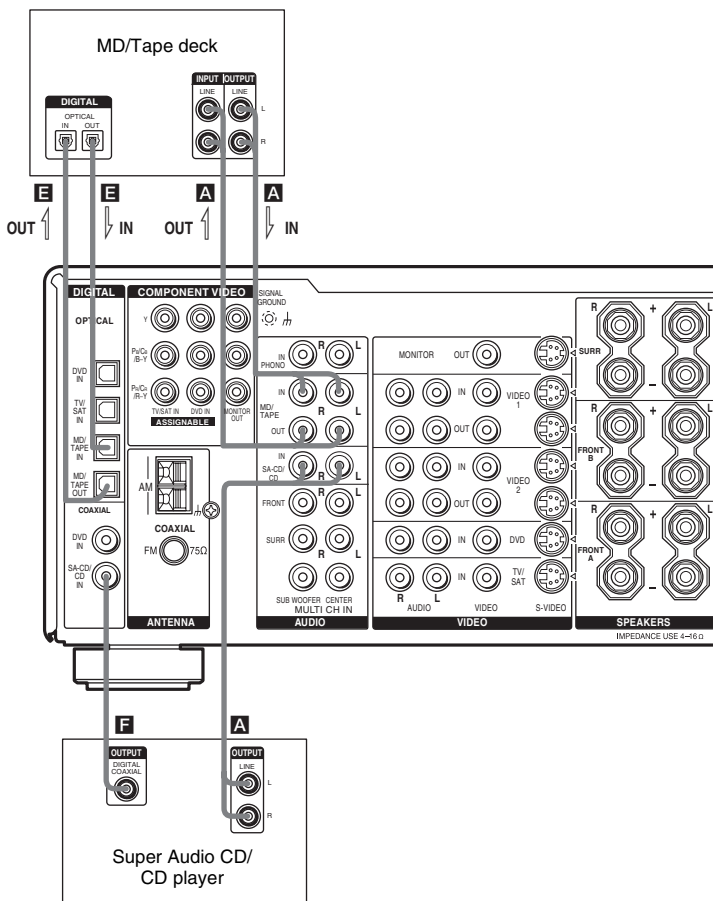

Tip

All the digital audio jacks are compatible with 32 kHz, 44.1 kHz, 48 kHz and 96 kHz sampling frequencies.

Notes

- It is not possible to record analog signals to components connected to the MD/TAPE OUT, VIDEO 1 AUDIO OUT or VIDEO 2 AUDIO OUT jacks if you make only digital connections. Likewise, you cannot record digital signals if you make only analog connections. To record analog signals, make analog connections. To record digital signals, make digital connections.
- The sound is not output when you play a Super Audio CD on the Super Audio CD player connected to the SA-CD/CD COAXIAL IN jack on this receiver. Connect to the analog input jacks (SA-CD/CD IN jacks). Refer to the operating instructions supplied with the Super Audio CD player.

1b: Connecting components with multi channel output jacks

1 Connect the audio jacks.

If your DVD or Super Audio CD player is equipped with multi channel output jacks, you can connect it to this receiver's MULTI CH IN jacks to enjoy the multi channel sound. Alternatively, the multi channel input jacks can be used to connect an external multi channel decoder. For details on the required cords (**A-H**), see page 5.

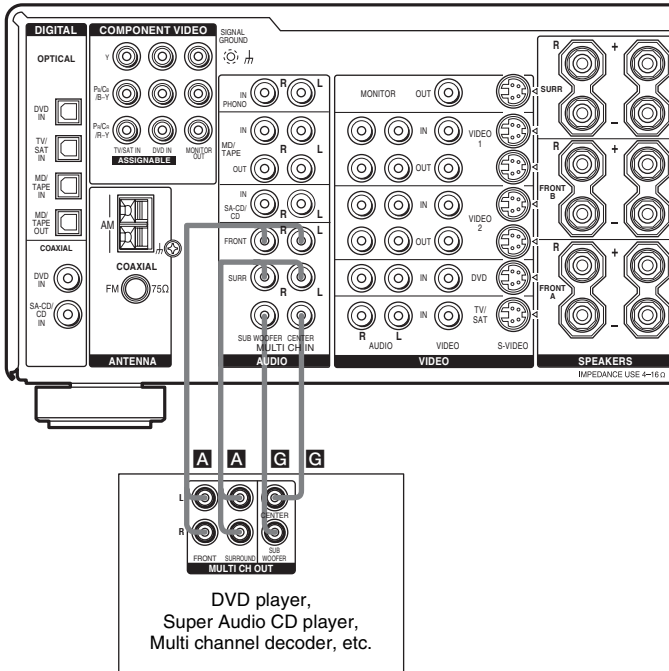

Tip

This connection also allows you to enjoy software with multi channel audio recorded in formats other than the Dolby Digital and DTS.

Note

When you make connections to the MULTI CH IN jacks, you will need to adjust the level of the speakers and sub woofer using the controls on the connected component.

2 Connect the video jacks.

The following illustration shows how to connect a DVD player with COMPONENT VIDEO (Y, Pb/Cb/B-Y, Pr/Cr/R-Y) output jacks. Connecting a TV with component video input jacks allows you to enjoy higher quality video.

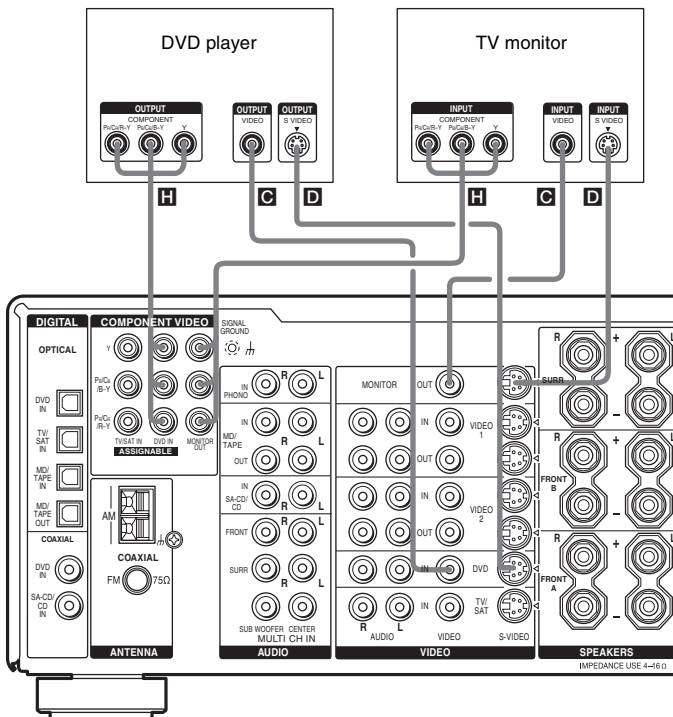

Tips

- When using the S-video jacks instead of the video jacks, your monitor must also be connected via an S-video jack. S-video signals are on a separate bus from the video signals and will not be output through the video jacks.
- On this receiver, standard video signals can be converted to S-video signals and this upconverted video signals can only be output from the MONITOR S-VIDEO OUT jack.

1c: Connecting components with only analog audio jacks

Hooking up audio components

For details on the required cords (A-H), see page 5.

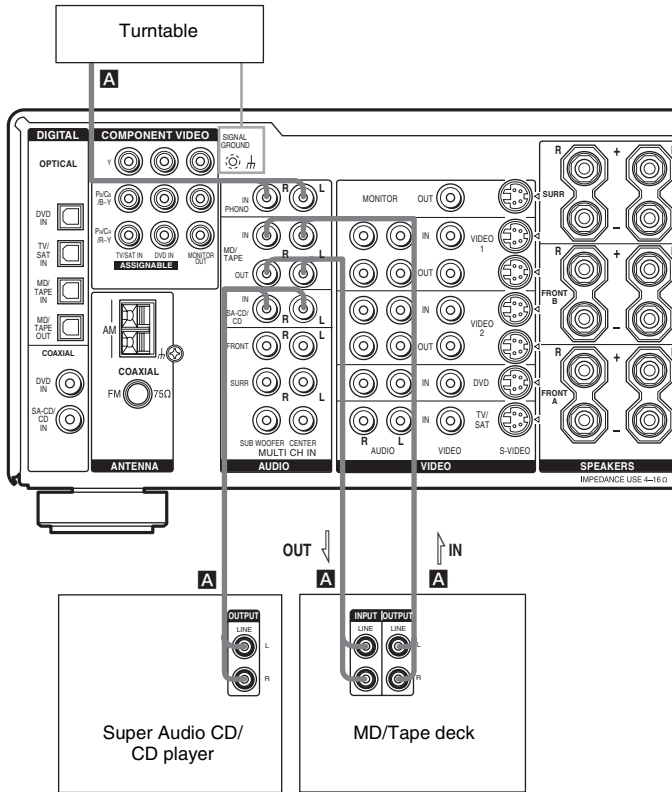

Note

If your turntable has a ground wire, connect it to the ⚡ SIGNAL GROUND terminal.

Hooking up video components

If you connect your TV to the MONITOR jacks, you can watch the video from the selected input (page 22). For details on the required cords (**A-H**), see page 5.

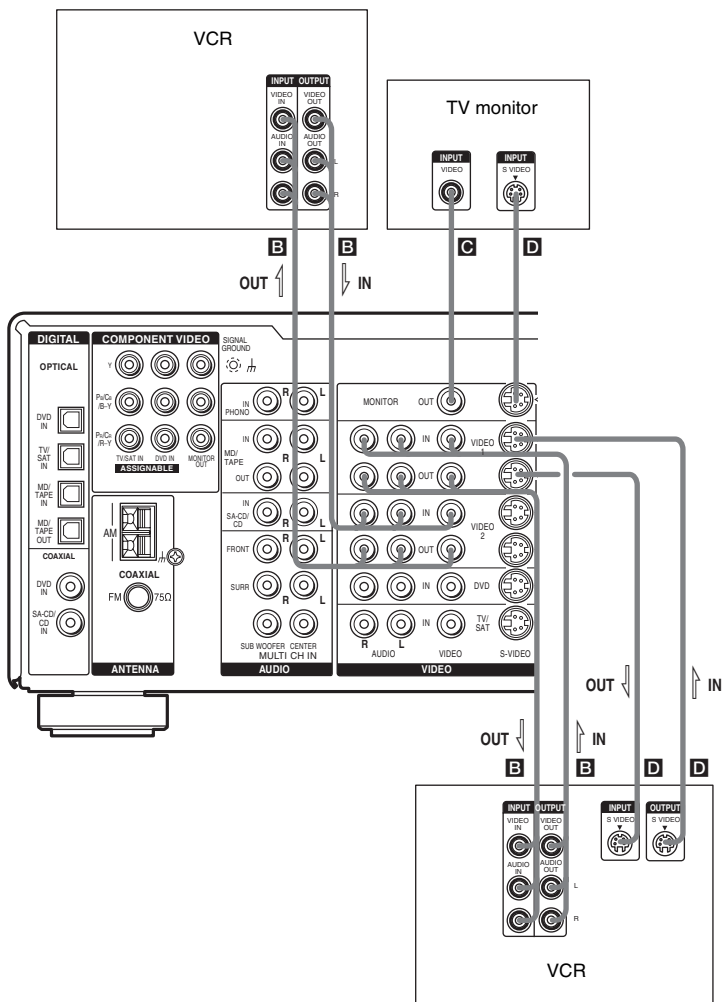

Tips

- When using the S-video jacks instead of the video jacks, your monitor must also be connected via an S-video jack. S-video signals are on a separate bus from the video signals and will not be output through the video jacks.
- On this receiver, standard video signals can be converted to S-video signals and this upconverted video signals can only be output from the MONITOR S-VIDEO OUT jack.

2: Connecting the antennas

Connect the supplied AM loop antenna and FM wire antenna.

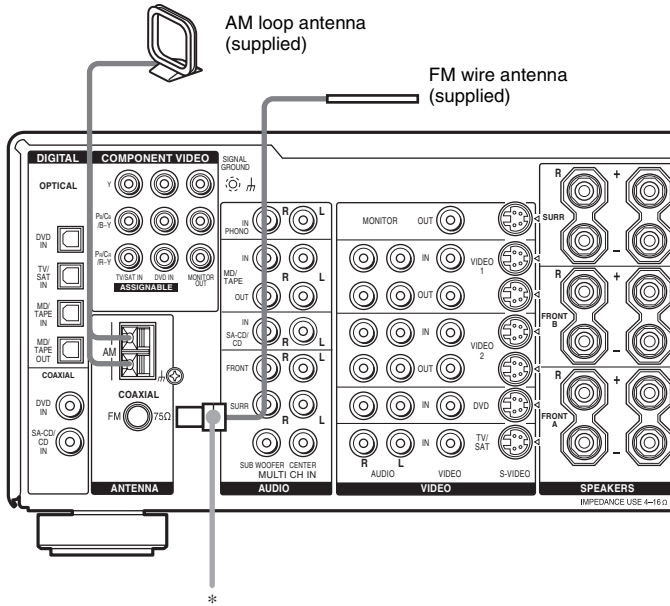

* The shape of the connector varies depending on the area code.

Notes

- To prevent noise pickup, keep the AM loop antenna away from the receiver and other components.
- Be sure to fully extend the FM wire antenna.
- After connecting the FM wire antenna, keep it as horizontal as possible.
- Do not use the h SIGNAL GROUND terminal for grounding the receiver.

3: Connecting speakers

Connect your speakers to the receiver. This receiver allows you to use a 7.1 channel speaker system. To fully enjoy theater-like multi channel surround sound requires five speakers (two front speakers, a center speaker, and two surround speakers) and a sub woofer (5.1 channel).

You can enjoy high fidelity reproduction of DVD software recorded in the Surround EX format if you connect one additional surround back speaker (6.1 channel) or two surround back speakers (7.1 channel) (see “Selecting the surround back decoding mode” on page 35).

Example of 7.1 channel speaker system configuration

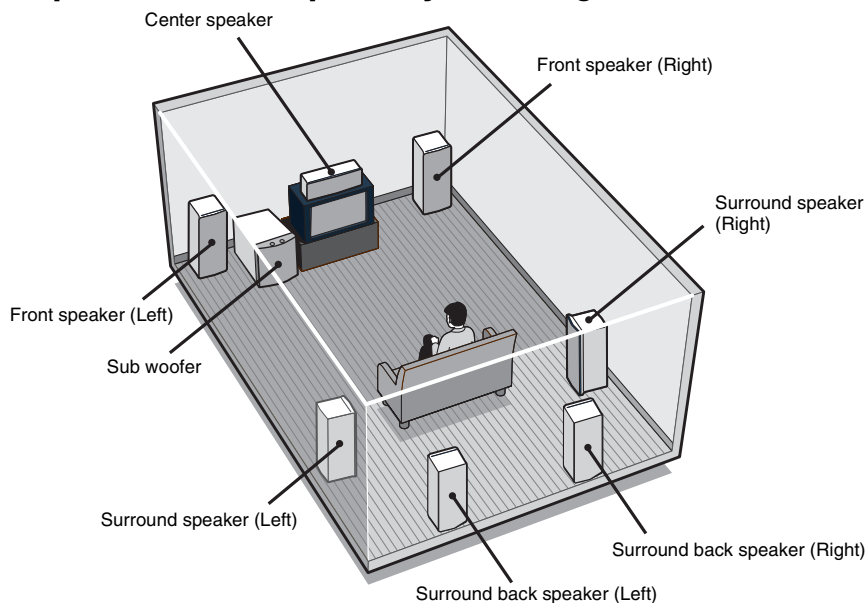

Tips

- When you connect 6.1 channel speaker system, place the surround back speaker behind the listening position (see “When placing only one surround back speaker” illustration on page 19).
- Since the sub woofer does not emit highly directional signals, you can place it wherever you want.

Speaker impedance

(Except for models of area code CEK)

To enjoy the best possible multi channel surround, connect speakers with a nominal impedance of 8 ohms or higher to the FRONT A or FRONT B, CENTER, SURR and SURR BACK terminals, and set the IMPEDANCE SELECTOR to “8Ω”. Use the screwdriver to set the impedance selector to the correct position. Refer to the operating instructions supplied with your speakers if you are not sure of their impedance. (This information is often on the back of the speaker.)

Alternatively, you may connect speakers with nominal impedances between 4 and 8 ohms to any or all of the speaker terminals. However, be sure to set the IMPEDANCE SELECTOR to “4Ω” if you connect even one speaker with a nominal impedance between 4 and 8 ohms.

Note

Be sure to turn the power off before adjusting the IMPEDANCE SELECTOR.

Required cords

A Speaker cords (not supplied)



B Monaural audio cord (not supplied)

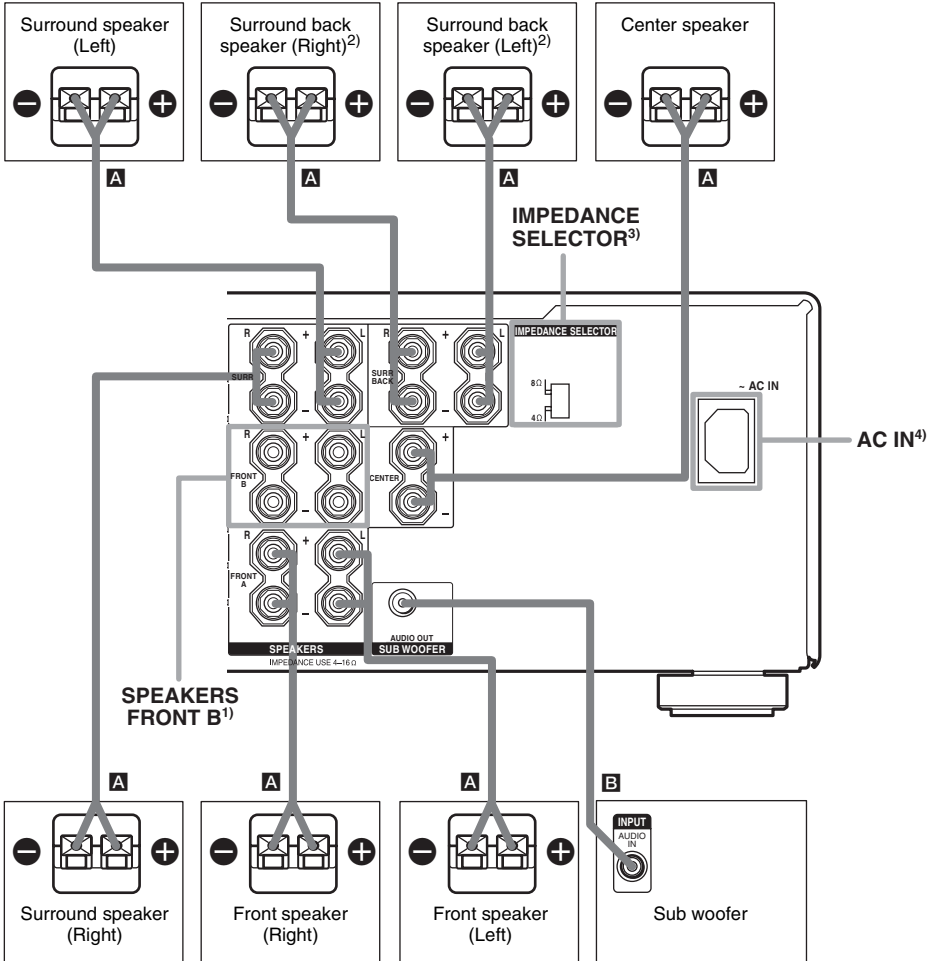

¹⁾ If you have an additional front speaker system, connect them to the SPEAKERS FRONT B terminals. You can select the front speakers you want to use with SPEAKERS (OFF/A/B/A+B) button. For details, see “Selecting the speaker system” (page 46).

²⁾ If you connect only one surround back speaker, connect it to the SPEAKERS SURR BACK L terminals.

³⁾ Except for models of area code CEK.

⁴⁾ Except for models of area code TW (Taiwan). For details, see “Connecting the AC power cord” on page 16.

4: Connecting the AC power cord

Connecting the AC power cord

(Models of area code **CEL**, **CEK** only)

Connect the supplied AC power cord to the AC IN terminal on the receiver, then connect the AC power cord to a wall outlet.

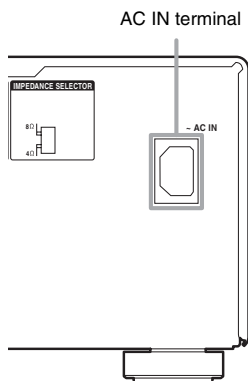
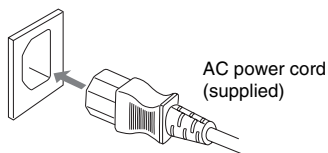

(Models of area code **TW** (Taiwan) only)

Connect the AC power cord to a wall outlet.

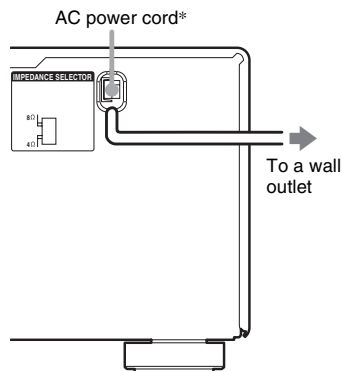

* The AC power cord for Taiwan model is non-detachable.

Performing initial setup operations

Before using the receiver for the first time, initialize the receiver by performing the following procedure.

This procedure can also be used to return settings you have made to their factory defaults. Use the buttons on the receiver for the operation.

1 Press I/⏻ to turn off the receiver.

2 Hold down I/⏻ for 5 seconds.

“PUSH” and “ENTER” appears in the display alternately.

3 Press MEMORY/ENTER.

“CLEARING” appears in the display for a while, then “CLEARED” appears.

The following are reset to their factory settings.

- All settings in the SPEAKER SETUP, LEVEL, EQUALIZER, CUSTOMIZE and TUNER menus.
- The sound field memorized for each input and preset station.
- All sound field parameters.
- All preset stations.
- All index names for inputs and preset stations.
- MASTER VOLUME +/- is set to “-∞dB” (volume minimum).
- INPUT SELECTOR is set to “DVD”.

5: Setting up the speakers

You can use the SPEAKER SETUP menu to set the size and distance of the speakers connected to this system.

- 1** Press **I/⏻** to turn on the system.
- 2** Press **MAIN MENU** repeatedly to select “**SP SETUP**”.
- 3** Turn **MENU** to select the parameter you want to adjust.

For details, see “SPEAKER SETUP menu parameters” below.

Note

Some speaker setup items may appear dimmed in the display. This means that they have been adjusted automatically due to other speaker settings or may not be adjustable.

- 4** Turn **-/+** to select the setting you want. The setting is entered automatically.

Note

Press **MEMORY/ENTER** if you select the setting for “**SP PAT. X -X**”.

- 5** Repeat steps 3 and 4 until you have set all of the items that follow.

SPEAKER SETUP menu parameters

The initial setting is underlined.

■ **XXXX SET (Speaker easy setup)**

- EASY
If you want to set up your speakers automatically, select “EASY SET”. You can select a pre-defined speaker pattern (see the supplied “Easy Setup Guide”).
- NORM.

If you want to adjust the settings of each speaker manually, select “NORM. SET”.

■ **SP PAT. X -X (Speaker setup pattern)**

When you select “EASY SET”, select the speaker setup pattern. Turn **-/+** to select the speaker setup pattern and press **MEMORY/ENTER** to enter the selection. Check your speaker pattern using the supplied “Easy Setup Guide”.

■ **S.W. XXX (Sub woofer selection)**

- YES
If you connect a sub woofer, select “YES”.
- NO
If you did not connect a sub woofer, select “NO”. The front speakers are automatically set to “LARGE” and you cannot change this setting. This activates the bass redirection circuitry and outputs the LFE signals from other speakers.

Note

In order to take full advantage of the Dolby Digital bass redirection circuitry, we recommend that you set the cut off frequency on the sub woofer as high as possible.

■ **XXXXX (Front speakers size)**

- LARGE
If you connect large speakers that will effectively reproduce bass frequencies, select “LARGE”. Normally, select “LARGE”.

- SMALL

If the sound is distorted, or you feel a lack of surround effects when using multi channel surround sound, select “SMALL” to activate the bass redirection circuitry and output the front channel bass frequencies from the sub woofer. When the front speakers are set to “SMALL”, the center, surround and surround back speakers are also automatically set to “SMALL” (unless previously set to “NO”).

■ **XXXXX (Center speaker size)**

- LARGE

If you connect a large speaker that will effectively reproduce bass frequencies, select “LARGE”. Normally, select “LARGE”.

However, if the front speakers are set to “SMALL”, you cannot set the center speaker to “LARGE”.

- SMALL

If the sound is distorted, or you feel a lack of surround effects when using multi channel surround sound, select “SMALL” to activate the bass redirection circuitry and output the center channel bass frequencies from the front speakers (if set to “LARGE”) or sub woofer.

- **NO**
If you did not connect a center speaker, select “NO”. The sound of the center channel will be output from the front speakers (DIGITAL DOWNMIX).
- **MIX**
If you did not connect a center speaker but want to downmix the center channel audio, select “MIX”.
This setting only available when the front speakers are set to “LARGE” (ANALOG DOWNMIX). In other cases, the center channel will be downmixed digitally (DIGITAL DOWNMIX).

Note

When using MULTI CH IN sources, the sound of the center channel is output from the front speakers if you select either “NO” or “MIX”.

■   **XXXXX (Surround speakers size)**

- **LARGE**
If you connect large speakers that will effectively reproduce bass frequencies, select “LARGE”. Normally, select “LARGE”. However, if the front speakers are set to “SMALL”, you cannot set the surround speakers to “LARGE”.
- **SMALL**
If the sound is distorted, or you feel a lack of surround effects when using multi channel surround sound, select “SMALL” to activate the bass redirection circuitry and output the surround channel bass frequencies from the sub woofer or other “LARGE” speakers.
- **NO**
If you did not connect surround speakers, select “NO”.

■    **XXXXXX (Surround back speaker selection)**

- **DUAL**
If you connect two surround back speakers, select “DUAL”. The sound will be output to a maximum of 7.1 channels.
- **SINGLE**
If you connect only one surround back speaker, select “SINGLE”. The sound will be output to a maximum of 6.1 channels.
- **NO**
If you did not connect surround back speakers, select “NO”.

Note

When the surround speakers size parameter is set to “NO”, the surround back speakers selection parameter is also automatically set to “NO”.

Tip

The “LARGE” and “SMALL” settings for each speaker determine whether the internal sound processor will cut the bass signal from that channel. When the bass is cut from a channel, the bass redirection circuitry sends the corresponding bass frequencies to the sub woofer or other “LARGE” speakers.

However, since bass sounds have a certain amount of directionality, it is best not to cut them, if possible. Therefore, even when using small speakers, you can set them to “LARGE” if you want to output the bass frequencies from that speaker. On the other hand, if you are using a large speaker, but prefer not to have bass frequencies output from that speaker, set it to “SMALL”.

If the overall sound level is lower than you prefer, set all speakers to “LARGE”. If there is not enough bass, you can use the BASS parameter in the EQUALIZER menu to boost the bass levels. To adjust the equalizer, see page 39.

■ DIST. X.X m (Front speaker distance)

Initial setting: 3.0 m

Lets you set the distance from your listening position to the front speakers (A). You can adjust from 1.0 meter to 7.0 meters in 0.1 meter steps.

If both front speakers are not placed an equal distance from your listening position, set the distance to the closest speaker.

When placing only one surround back speaker

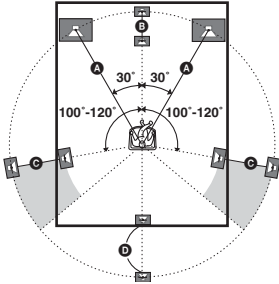

When placing two surround back speakers
(The angle E should be the same)

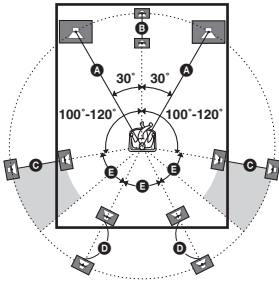

■ DIST. X.X m (Center speaker distance)

Initial setting: 3.0 m

Lets you set the distance from your listening position to the center speaker. Center speaker distance should be set from a distance equal to the front speaker distance (A) to a distance 1.5 meters closer to your listening position (B).

■ DIST. X.X m (Surround speaker distance)

Initial setting: 3.0 m

Lets you set the distance from your listening position to the surround speakers. Surround speaker distance should be set from a distance equal to the front speaker distance (A) to a distance 4.5 meters closer to your listening position (C).

If both surround speakers are not placed an equal distance from your listening position, set the distance to the closest speaker.

■ DIST. X.X m (Surround back speaker distance)

Initial setting: 3.0 m

Lets you set the distance from your listening position to the surround back speaker. Surround back speaker distance should be set from a distance equal to the front speaker distance (A) to a distance 4.5 meters closer to your listening position (D).

If you connect two surround back speakers and both surround back speakers are not placed an equal distance from your listening position, set the distance to the closest speaker.

Tip

The receiver lets you to input the speaker position in terms of distance. However, it is not possible to set the center speaker further than the front speakers. Also, the center speaker cannot be set more than 1.5 meters closer than the front speakers.

Likewise, the surround speakers cannot be set further away from the listening position than the front speakers. And they can be no more than 4.5 meters closer.

This is because incorrect speaker placement is not conducive to the enjoyment of surround sound.

Please note that, setting the speaker distance closer than the actual location of the speakers will cause a delay in the output of the sound from that speaker. In other words, the speaker will sound like it is further away.

For example, setting the center speaker position will create a fairly realistic sensation of being "inside" the screen. If you cannot obtain a satisfactory surround effect because the surround speakers are too close, setting the surround speaker distance closer (shorter) than the actual distance will create a larger sound stage. Adjusting these parameter while listening to the sound often results in much better surround sound. Give it a try!

For advanced speaker setups

Set “MENU XXX” in the CUSTOMIZE menu to “MENU EXP.” (page 40). This enables advanced setups including those of the heights of the surround speakers, positioning of the surround speakers and speaker crossover frequency.

For details on how to set the items, see page 41.

6: Adjusting the speaker levels and balance

— TEST TONE

Adjust the speaker levels and balance while listening the test tone from your listening position.

Use the remote for the operation.

Tip

The receiver employs a test tone with a frequency centered at 800 Hz.

1 Press I/⏻ to turn on the receiver.

2 Press TEST TONE.

“AUTO L” appears in the display. The test tone is output from each speaker in sequence and the display will automatically change as follows:

AUTO L (Front left) → AUTO C (Center)
→ AUTO R (Front right) → AUTO SR
(Surround right) → AUTO SBR (Surround
back right)* → AUTO SBL (Surround
back left)* → AUTO SL (Surround left)
→ AUTO SW (Sub woofer)

* You will only hear the test tone from the

- surround back left and right speakers when surround back speaker selection parameter is set to “DUAL”.
- surround back left speaker when surround back speaker selection parameter is set to “SINGLE”. “AUTO SB” appears in the display instead of “AUTO SBR” or “AUTO SBL”.

3 Adjust the speaker level and balance using the LEVEL menu so that the level of the test tone sounds the same from each speaker.

For details on the LEVEL menu settings, see page 38.

Tips

- The adjusted value are shown in the display during adjustment.
- To adjust the level of all speakers at the same time, press MASTER VOL +/- on the remote or turn MASTER VOLUME +/- on the receiver.

4 Press TEST TONE again after adjustment.

The test tone turns off.

To output the test tone only from a specific speaker

Set “T. TONE” in the LEVEL menu to “FIX” (page 38). The test tone is output only from the selected speaker.

For more precise adjustment

You can output the test tone or sound source from two adjacent speakers to adjust their balance and level.

Set “MENU XXX” in the CUSTOMIZE menu to “MENU EXP.” (page 40). Then select the two speakers you want to adjust using “P. NOISE” or “P. AUDIO” in the LEVEL menu (page 43).

Notes

- The test tone cannot be used when ANALOG DIRECT or MULTI CH IN function is used.
- Although these adjustments can also be made via the front panel using the LEVEL menu (when the test tone is output, the receiver switches to the LEVEL menu automatically), we recommend you follow the procedure described above and adjust the speaker levels from your listening position using the remote.

Amplifier Operation

Selecting the component

1 Turn INPUT SELECTOR to select the input.

The selected input appears in the display.

To select the	Display
VCR	VIDEO 1 or VIDEO 2
Video game player	VIDEO 3
DVD player	DVD
Satellite tuner	TV/SAT
MD or tape deck	MD/TAPE
Super Audio CD or CD player	SA-CD/CD
Built-in tuner (FM)	FM and frequency
Built-in tuner (AM)	AM and frequency
Turntable	PHONO

2 Turn on the component and start playback.

Note

If you select any video components, set the TV's video input to match the component you selected.

3 Turn MASTER VOLUME $-/+$ to adjust the volume.

Note

To avoid damaging your speakers, make sure that you turn down the volume before you turn off the receiver.

To mute the sound

Press MUTING on the remote.

The muting function will be canceled when you do the following.

- Press MUTING on the remote again.
- Turn the power off.
- Increase the volume.

To use the headphones

Connect the headphones to the PHONES jack.

- When the headphones are connected, speaker output is automatically canceled and "SP A" and "SP B" do not light up in the display.
- When the headphones are connected, you can select only the following sound fields (page 34).
 - HP 2CH (HEADPHONE 2CH)
 - HP DIR (HEADPHONE DIRECT)
 - HP MULTI (HEADPHONE MULTI)
 - HP THEA (HEADPHONE THEATER)

Listening to multi channel sound

— MULTI CH IN

You can select the audio directly from the components connected to the MULTI CH IN jacks. This enables you to enjoy high quality analog inputs like DVD or Super Audio CD. Also see “D.PWR XXX” (page 41).

When the MULTI CH IN function is selected, the equalizer and sound field cannot be used.

Press MULTI CH IN.

Press again to cancel the MULTI CH IN function.

When a center speaker or sub woofer is not connected

If you have set the center speaker to “NO” or “MIX”, or set the sub woofer to “NO” in the SPEAKER SETUP menu (page 17), and you activate the MULTI CH IN function, the analog center or sub woofer audio will be output from the front left and right speakers.

When MULTI CHANNEL DECODING indicator lights up

The MULTI CHANNEL DECODING indicator lights up when the receiver is decoding multi channel sources.

However, this indicator does not light up if you select 2CH STEREO mode.

Listening to FM/AM radio

You can listen to FM and AM broadcasts through the built-in tuner. Before operation, make sure you have connected the FM and AM antennas to the receiver (see page 13).

Tip

The tuning scale differs depending on the area code as shown in the following table. For details on area codes, see page 2.

Area code	FM	AM
CEL, CEK, TW	50 kHz	9 kHz

Automatic tuning

If you do not know the frequency of the station you want, you can let the receiver scan all available stations in your area.

1 Turn INPUT SELECTOR to select FM or AM band.

The last received station is tuned in.

2 Press TUNING + or TUNING –.

Press TUNING + to scan from low to high; press TUNING – to scan from high to low.

The receiver stops scanning whenever a station is received.

In case of poor FM stereo reception

If the FM stereo reception is poor and “STEREO” flashes in the display, select monaural audio so that the sound will be less distorted.

1 Press MAIN MENU repeatedly to select “TUNER”.

2 Turn MENU to select “FM AUTO”.

3 Turn –/+ to select “FM MONO”.

The FM reception switches to monaural.

Tip

You will not be able to enjoy the stereo effect, but the sound will be less distorted. To return to stereo mode, select “FM AUTO” in step 3.

Direct tuning

You can enter the frequency of the station you want directly.

Use the remote for the operation.

1 Press TUNER repeatedly to select FM or AM band.

The last received station is tuned in.

Tip

You can also use INPUT SELECTOR on the receiver.

2 Press D.TUNING.

3 Press the numeric buttons to enter the frequency.

Example 1: FM 102.50 MHz

Press 1 → 0 → 2 → 5 → 0

Example 2: AM 1,350 kHz

Press 1 → 3 → 5 → 0

If you have tuned in an AM station, adjust the direction of the AM loop antenna for optimum reception.

If you cannot tune in a station and the entered numbers flash

Make sure you have entered the right frequency. If not, repeat step 3. If the entered numbers still flash, the frequency is not used in your area.

Storing FM stations automatically

— AUTOBETICAL

(Models of area code CEL, CEK only)

This function lets you store up to 30 FM and FM RDS stations in alphabetical order without redundancy. Additionally, it only stores the stations with the clearest signals.

If you want to store FM or AM stations one by one, see “Presetting radio stations” (page 25). Use the buttons on the receiver for the operation.

Note

To avoid damaging your speakers, make sure that you turn down the volume before you use the AUTOBETICAL function.

1 Press I/⏻ to turn off the receiver.

2 Hold down MEMORY/ENTER and press I/⏻ to turn the receiver back on.

“AUTO-BETICAL SELECT” appears in the display and the receiver scans and stores all the FM and FM RDS stations in the broadcast area.

For RDS stations, the tuner first checks for stations broadcasting the same program, then stores only the one with the clearest signal. The selected RDS stations are sorted alphabetically by their Program Service name, then assigned a 2-character preset code. For more details on RDS, see page 26.

Regular FM stations are assigned 2-character preset codes and stored after the RDS station.

When done, “FINISH” appears in the display momentarily and the receiver returns to the normal operation.

Notes

- Do not press any button on the receiver or supplied remote during autobetrical operation, except I/⏻.
- If you move to another area, repeat this procedure to store stations in your new area.
- For details on tuning the stored stations, see “Tuning to preset stations” (page 25).
- If you move the antenna after storing stations with this procedure, the stored settings may no longer be valid. If this happens, repeat this procedure to store the stations again.

Presetting radio stations

You can preset up to 30 FM or AM stations. Then you can easily tune in the stations you often listen to.

Presetting radio stations

- 1 Turn **INPUT SELECTOR** to select **FM** or **AM** band.

The last received station is tuned in.

- 2 Tune in the station that you want to preset using **automatic tuning** (page 23) or **direct tuning** (page 24).

- 3 Press **MEMORY/ENTER**.

“MEMORY” indicator lights up in the display for a few seconds. Do steps 4 to 5 before the indication turns off.

- 4 Press **PRESET TUNING +** or **PRESET TUNING –** repeatedly to select a preset station number.

Each time you press the button, you can select the preset station number as follows:

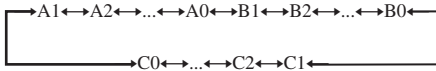

If “MEMORY” indication turns off before you select the preset station number, start again from step 3.

Tip

You can also use the remote to select a preset station number. Press **SHIFT** repeatedly to select a memory page (A, B or C) and then press the numeric buttons to select a preset number.

- 5 Press **MEMORY/ENTER** again.

The station is stored to the selected preset number.

If “MEMORY” indication turns off before you press **MEMORY/ENTER**, start again from step 3.

- 6 Repeat steps 2 to 5 to preset another station.

Tuning to preset stations

- 1 Turn **INPUT SELECTOR** to select **FM** or **AM** band.

The last received station is tuned in.

- 2 Press **PRESET TUNING +** or **PRESET TUNING –** repeatedly to select the preset station you want.

Each time you press the button, you can select the preset station as follows:

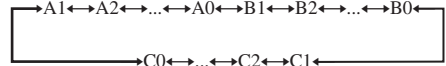

Using the remote

- 1 Press **TUNER** repeatedly to select **FM** or **AM** band.
- 2 Press **PRESET/CH/D.SKIP +/-** repeatedly to select the preset station you want.

To select the preset station directly

Press the numeric buttons on the remote.

The preset station of the selected number in the current memory page is tuned in. Press **SHIFT** repeatedly on the remote to change the memory page.

Using the Radio Data System (RDS)

(Models of area code CEL, CEK only)

This receiver also allows you to use RDS (Radio Data System), which enables radio stations to send additional information along with the regular program signal. You can also display RDS information.

Notes

- RDS is operable only for FM stations.
- Not all FM stations provide RDS service, nor do they provide the same types of services. If you are not familiar with the RDS services in your area, check with your local radio stations for details.

Receiving RDS broadcasts

Simply select a station on the FM band using automatic tuning (page 24), direct tuning (page 23), or preset tuning (page 25).

When you tune in a station that provides RDS services, the “RDS” indicator lights up and the program service name appears in the display.

Note

RDS may not work properly if the station you tuned to is not transmitting the RDS signal properly or if the signal strength is weak.

Displaying RDS information

While receiving an RDS station, press **DISPLAY** repeatedly.

Each time you press **DISPLAY**, RDS information on the display changes cyclically as follows:

Program Service name → Frequency → Program Type indication^{a)} → Radio Text indication^{b)} → Current Time indication (in 24-hour system) → Sound field currently applied → Volume level

^{a)} Type of program being broadcast (see page 26).

^{b)} Text messages sent by the RDS station.

Notes

- If there is an emergency announcement by government authorities, “ALARM” flashes in the display.
- When the message consists of 9 characters or more, the message scrolls across the display.
- If a station does not provide a particular RDS service, “NO XXXX” (such as “NO TEXT”) appears in the display.

Description of program types

Program type indication	Description
NEWS	News programs
AFFAIRS	Topical programs that expand on current news
INFO	Programs offering information on a wide spectrum of subjects, including consumer affairs and medical advice
SPORT	Sports programs
EDUCATE	Educational programs, such as “how-to” and advice programs
DRAMA	Radio plays and serials
CULTURE	Programs about national or regional culture, such as language and social concerns
SCIENCE	Programs about the natural sciences and technology
VARIED	Other types of programs such as celebrity interviews, panel games, and comedy
POP M	Popular music programs
ROCK M	Rock music programs
EASY M	Easy Listening
LIGHT M	Instrumental, vocal, and choral music
CLASSICS	Performances of major orchestras, chamber music, opera, etc.
OTHER M	Music that does not fit into any categories above, such as Rhythm & Blues and Reggae
WEATHER	Weather information
FINANCE	Stock market reports and trading, etc.
CHILDREN	Programs for children
SOCIAL	Programs about people and the things that affect them

Program type indication	Description
RELIGION	Programs of religious content
PHONE IN	Programs where members of the public express their views by phone or in a public forum
TRAVEL	Programs about travel. Not for announcements that are located by TP/TA.
LEISURE	Programs on recreational activities such as gardening, fishing, cooking, etc.
JAZZ	Jazz programs
COUNTRY	Country music programs
NATION M	Programs featuring the popular music of the country or region
OLDIES	Programs featuring oldies music
FOLK M	Folk music programs
DOCUMENT	Investigative features
NONE	Any programs not defined above

Changing the display

Changing the information in the display

You can check the sound field etc. by changing the information in the display.

Press DISPLAY repeatedly.

Each time you press DISPLAY, the display will change cyclically as follows:

Index name of the input* → Selected input → Sound field currently applied → Volume level

When the tuner is selected

Program Service name** or index name of the preset station* → Frequency → Program Type indication** → Radio Text indication** → Current Time indication (in 24-hour system)** → Sound field currently applied → Volume level

* Index name appears only when you have assigned one to the input or preset station (page 44). Index name does not appear when only blank spaces have been entered, or it is the same as the input name.

** During RDS reception only. (Models of area code CEL, CEK only. See page 26.)

About the indications in the display

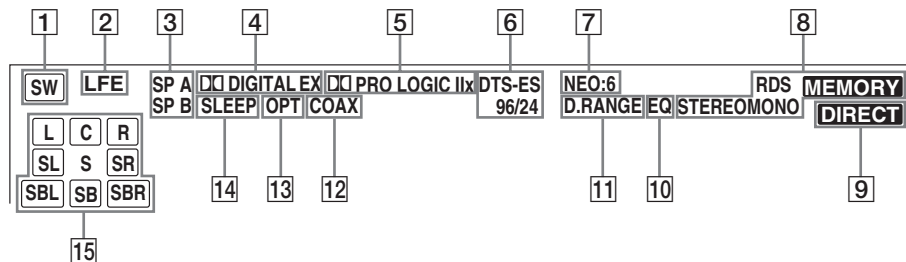

- 1** **SW**: Lights up when sub woofer selection is set to “YES” (page 17) and the audio signal is output from the SUB WOOFER jack. This indicator does not light up during the 2CH STEREO mode.
- 2** **LFE**: Lights up when the disc being played back contains the LFE (Low Frequency Effect) channel and the LFE channel signal is actually being reproduced.
- 3** **SP A/SP B**: Lights up in accordance with the speaker system being used (A or B). Turns off when speaker output is turned off or when headphones are connected.
- 4** **DIGITAL EX**: “DIGITAL” lights up when the receiver is decoding signals recorded in the Dolby Digital format. “DIGITAL EX” lights up when the receiver is decoding signals recorded in the Dolby Digital EX format.

Note

When playing a Dolby Digital format disc, be sure that you have made digital connections and that INPUT MODE is not set to “ANALOG” (page 37).

- 5** **PRO LOGIC IIX**: “PRO LOGIC” lights up when the receiver applies Pro Logic processing to 2 channel signals in order to output the center and surround channel signals. “PRO LOGIC II” lights up when the Pro Logic II Movie/Music/Game decoder is activated. “PRO LOGIC IIX” lights up when the Pro Logic IIX Movie/Music/Game decoder is activated. However, these indicators do not light up if both the center and surround speakers are set to “NO” and you select a sound field using the A.F.D. button.

Note

Dolby Pro Logic IIX decoding does not function for DTS format signals and for signals with a sampling frequency of more than 48 kHz.

- 6** **DTS-ES 96/24**: “DTS” lights up when DTS signals are input. “DTS-ES” lights up when DTS-ES signals are input. “DTS 96/24” lights up when the receiver is decoding DTS 96 kHz/24 bit signals.

Note

When playing a DTS format disc, be sure that you have made digital connections and that INPUT MODE is not set to “ANALOG” (page 37).

- 7** **NEO:6**: Lights up when DTS Neo:6 Cinema/Music mode decoding is activated.
- 8** **Tuner indicators**: Lights up when using the receiver to tune in radio stations, etc. See pages 23–27 for tuner operations.

Note

“RDS” lights up for models of area code CEL, CEK only.

- 9 DIRECT:** Lights up when the ANALOG DIRECT function is activated.
- 10 EQ:** Lights up when the equalizer is activated.
- 11 D.RANGE:** Lights up when dynamic range compression is activated (page 43).
- 12 COAX:** Lights up when the source signal is a digital signal being input through the COAXIAL terminal (page 37).
- 13 OPT:** Lights up when the source signal is a digital signal being input through the OPTICAL terminal (page 37).
- 14 SLEEP:** Lights up when sleep timer is activated.
- 15 Playback channel indicators:** The letters (L, C, R, etc.) indicate the channels being played back. The boxes around the letters vary to show how the receiver downmixes the source sound (based on the speakers settings).
L (Front Left), R (Front Right), C (Center (monaural)), SL (Surround Left), SR (Surround Right), S (Surround (monaural or the surround components obtained by Pro Logic processing)), SB (Surround Back (the surround back components obtained by 6.1 channel decoding)), SBL (Surround Back Left), SBR (Surround Back Right)

Example:

Recording format (Front /Surround): 3/2

Output channel: When the surround speakers size parameter is set to "NO"

Sound Field: A.F.D. AUTO

L	C	R
SL		SR

Enjoying Surround Sound

Using only the front speakers

In this mode, the receiver outputs the sound from the front left/right speakers only. There is no sound from the sub woofer.

Listening to 2 channel stereo sources (2CH STEREO)

Standard 2 channel stereo sources completely bypass the sound field processing and multi channel surround formats are downmixed to 2 channel.

Press 2CH.

“2CH ST.” appears in the display and the receiver switches to the 2CH STEREO mode.

Note

No sound is output from the sub woofer in the 2CH STEREO mode. To listen to the 2 channel stereo sources using the front left/right speakers and a sub woofer, set A.F.D. mode to “A.F.D. AUTO”.

Listening to analog audio (ANALOG DIRECT)

You can switch the audio of the selected input to the two channel analog input. This function enables you to enjoy high quality analog sources. Also see “D.PWR XXX” on page 41. When using this function, only the volume and front speaker balance can be adjusted.

1 Turn **INPUT SELECTOR** to select the input you want to listen to in analog audio.

2 Press **DIRECT**.

“A. DIRECT” appears in the display and the analog audio is output.

Press again to cancel the ANALOG DIRECT function.

Notes

- This function is cancelled when you switch the sound field (pages 30-34).
- When this function is used, test tone function cannot be used.

Enjoying higher fidelity sound

— AUTO FORMAT DIRECT

The Auto Format Direct (A.F.D.) mode allows you to select the decoding mode you want for your audio sound.

A.F.D. mode (Display)	Decoding mode
A.F.D. AUTO (A.F.D. AUTO)	As encoded
PRO LOGIC (DOLBY PL)	Dolby Pro Logic
PRO LOGIC II MOVIE (PLII MV)	Dolby Pro Logic II
PRO LOGIC II MUSIC (PLII MS)	
PRO LOGIC II GAME (PLII GM)	
PRO LOGIC IIx MOVIE (PLIIX MV)	Dolby Pro Logic IIx
PRO LOGIC IIx MUSIC (PLIIX MS)	
PRO LOGIC IIx GAME (PLIIX GM)	
Neo:6 Cinema (NEO6 CIN)	DTS Neo:6
Neo:6 Music (NEO6 MUS)	
MULTI STEREO (MULTI ST.)	

Decoding the input audio signal automatically

In this mode, the receiver automatically detects the type of audio signal being input (Dolby Digital, DTS, standard 2 channel stereo, etc.) and performs the proper decoding if necessary. This mode presents the sound as it was recorded/encoded, without adding any surround effects. However, if there are no low frequency signals (Dolby Digital LFE, etc.) it will generate a low frequency signal for output to the sub woofer.

Press A.F.D. repeatedly to select “A.F.D. AUTO”.

The receiver automatically detects the type of audio signal being input and performs the proper decoding if necessary.

Tip

In most cases, “A.F.D. AUTO” provides the most appropriate decoding. You may want to use SURR BACK DECODING (page 35) to match the input stream to the mode you prefer.

Enjoying stereo sound in multi channel (2 channel decoding mode)

This mode lets you specify the type of decoding for 2 channel audio sources. This receiver can reproduce 2 channel sound in 5 channels through Dolby Pro Logic II; 7 channels through Dolby Pro Logic IIX; 6 channels through DTS Neo:6; or 4 channels through Dolby Pro Logic. However, DTS 2CH sources are not decoded by DTS Neo:6; they are output in 2 channels.

Press A.F.D. repeatedly to select the 2 channel decoding mode.

The selected type of decoding appears in the display.

■ DOLBY PL (PRO LOGIC)

Performs Dolby Pro Logic decoding. The source recorded in 2 channel is decoded into 4.1 channels.

■ PLII MV (PRO LOGIC II MOVIE)

Performs Dolby Pro Logic II Movie mode decoding. This setting is ideal for movies encoded in Dolby Surround. In addition, this mode can reproduce sound in 5.1 channel when watching videos of overdubbed or old movies.

■ PLII MS (PRO LOGIC II MUSIC)

Performs Dolby Pro Logic II Music mode decoding. This setting is ideal for normal stereo sources such as CDs.

■ PLII GM (PRO LOGIC II GAME)

Performs Dolby Pro Logic II Game mode decoding. This setting is ideal for video game softwares.

■ PLIIX MV (PRO LOGIC IIX MOVIE)

Performs Dolby Pro Logic IIX Movie mode decoding. This setting expands Dolby Pro Logic II Movie or Dolby Digital 5.1 to discrete 7.1 movie channels.

■ PLIIX MS (PRO LOGIC IIX MUSIC)

Performs Dolby Pro Logic IIX Music mode decoding. This setting shares hard “back” effects across all surround speakers.

■ PLIIX GM (PRO LOGIC IIX GAME)

Performs Dolby Pro Logic IIX Game mode decoding. This setting delivers full-impact special effect signals panned to the surround speakers.

Note

Dolby Pro Logic IIX decoding does not function for DTS format signals and for signals with a sampling frequency of more than 48 kHz.

■ NEO6 CIN (Neo:6 Cinema)

Performs DTS Neo:6 Cinema mode decoding.

■ NEO6 MUS (Neo:6 Music)

Performs DTS Neo:6 Music mode decoding. This setting is ideal for normal stereo sources such as CDs.

■ MULTI ST. (MULTI STEREO)

Outputs the 2 channel left/right signals from all speakers. The sound of speakers may not output depending on the speakers settings.

If you connect a sub woofer

When the audio signal is 2 channel stereo or if the source signal does not include a LFE signal, the receiver generates a low frequency signal for output to the sub woofer. However the low frequency signal is not generated for “NEO6 CIN” or “NEO6 MUS” when all speakers are set to “LARGE”.

Selecting a sound field

You can take advantage of surround sound simply by selecting one of the receiver's pre-programmed sound fields. They bring the exciting and powerful sound of movie theaters and concert halls into your home.

Selecting a sound field for movies

Press **MOVIE** repeatedly to select the sound field you want.

The selected sound field appears in the display.

Sound field	Display
CINEMA STUDIO EX A DCS	C.ST.EX A
CINEMA STUDIO EX B DCS	C.ST.EX B
CINEMA STUDIO EX C DCS	C.ST.EX C
VIRTUAL MULTI DIMENSION DCS	V. M. DIM

About DCS (Digital Cinema Sound)

Sound fields with **DCS** marks use DCS technology.

DCS is the concept name of the surround technology for home theater developed by Sony. DCS uses the DSP (Digital Signal Processor) technology to reproduce the sound characteristics of an actual cinema cutting studio in Hollywood.

When played at home, DCS will create a powerful theater effect that mimics the artistic combination of sound and action as envisioned by the movie director.

■ C.ST.EX A (CINEMA STUDIO EX A) **DCS**

Reproduces the sound characteristics of the Sony Pictures Entertainment "Cary Grant Theater" cinema production studio. This is a standard mode, great for watching most any type of movies.

■ C.ST.EX B (CINEMA STUDIO EX B) **DCS**

Reproduces the sound characteristics of the Sony Pictures Entertainment "Kim Novak Theater" cinema production studio. This mode is ideal for watching science-fiction or action movies with lots of sound effects.

■ C.ST.EX C (CINEMA STUDIO EX C) **DCS**

Reproduces the sound characteristics of the Sony Pictures Entertainment scoring stage. This mode is ideal for watching musicals or films where orchestra music is featured in the soundtrack.

■ V. M. DIM (VIRTUAL MULTI DIMENSION) **DCS**

Creates 5 sets of virtual speakers from a single pair of actual surround speakers.

About CINEMA STUDIO EX modes

CINEMA STUDIO EX modes are suitable for watching motion picture DVDs (etc.), with multi channel surround effects. You can reproduce the sound characteristics of Sony Pictures Entertainment's dubbing studio in your home.

The CINEMA STUDIO EX modes consist of the following three elements.

- Virtual Multi Dimension
Creates 5 sets of virtual speakers from a single pair of actual surround speakers.
- Screen Depth Matching
Creates the sensation that the sound is coming from inside the screen like in theaters.
- Cinema Studio Reverberation
Reproduces the type of reverberation found in theaters.

The CINEMA STUDIO EX modes integrate these three elements simultaneously.

Notes

- The effects provided by the virtual speakers may cause increased noise in the playback signal.
- When listening with sound fields that employ the virtual speakers, you will not be able to hear any sound coming directly from the surround speakers.

Selecting a sound field for music

Press **MUSIC** repeatedly to select the sound field you want.

The selected sound field appears in the display.

Sound field	Display
HALL	HALL
JAZZ CLUB	JAZZ
LIVE CONCERT	CONCERT

■ HALL

Reproduces the acoustics of a classical concert hall.

■ JAZZ (JAZZ CLUB)

Reproduces the acoustics of a jazz club.

■ CONCERT (LIVE CONCERT)

Reproduces the acoustics of a 300-seat live house.

When the headphones are connected

You can select only from the following sound fields.

■ HP 2CH (HEADPHONE 2CH)

Outputs the sound in 2 channel (stereo). Standard 2 channel stereo sources completely bypass the sound field processing and multi channel surround formats are downmixed to 2 channels.

■ HP DIR (HEADPHONE DIRECT)

Outputs the analog signals without processing by equalizer, sound field, etc.

■ HP MULTI (HEADPHONE MULTI)

Outputs the front analog signal from MULTI CH IN jacks.

■ HP THEA (HEADPHONE THEATER)



Allows you to experience a theater-like environment while listening through a pair of headphones.

Note

If you connect a pair of headphones while a sound field is operating, the system will automatically switch to HEADPHONE 2CH if using a sound field selected with the 2CH or A.F.D. button, or to HEADPHONE THEATER if using a sound field selected with the MOVIE or MUSIC button.

To turn off the surround effect

Press 2CH to select “2CH ST.” or press A.F.D. repeatedly to select “A.F.D. AUTO”.

Tip

You can identify the encoding format of DVD software, etc. by looking at the logo on the package.

- : Dolby Digital discs
- : Dolby Surround encoded programs
- : DTS Digital Surround encoded programs

Notes

- Sound fields do not function for the signals with a sampling frequency of more than 48 kHz.
- When one of the following sound fields are selected, no sound is output from the sub woofer if all the speakers are set to “LARGE” in the SPEAKER SETUP menu. However, the sound will be output from the sub woofer if the digital input signal contains LFE (Low Frequency Effect) signals, or if the front, center, or surround speakers are set to “SMALL”.
 - HALL
 - JAZZ CLUB
 - LIVE CONCERT

Selecting the surround back decoding mode

— *SURR BACK DECODING*

This function lets you select the decoding mode for the surround back signals of the multi channel input stream.

By decoding the surround back signal of DVD software (etc.) recorded in Dolby Digital EX, DTS-ES Matrix, DTS-ES Discrete 6.1, etc. format, you can enjoy the surround sound intended by the filmmakers.

Press SURR BACK DECODING repeatedly to select the surround back decoding mode.

“SB XXXX” appears in the display.

For details, see “How to select the surround back decoding mode” on page 36.

Tip

You can select the surround back decoding mode using “SB XXXX” in the CUSTOMIZE menu (page 40).

Note

You can select the surround back decoding mode only when A.F.D. mode is selected except for Dolby Pro Logic IIx mode (page 31).

How to select the surround back decoding mode

You can select the surround back decoding mode you want according to the input stream.

When you select “SB AUTO”

When the input stream contains the 6.1 channel decode flag^{a)}, the appropriate decoder is applied to decode the surround back signal.

Input stream	Output channel	Applied surround back decoder
Dolby Digital 5.1	5.1 ^{e)}	—
Dolby Digital EX ^{b)}	6.1	Matrix decoder conforms to Dolby Digital EX
DTS 5.1	5.1 ^{e)}	—
DTS-ES Matrix 6.1 ^{c)}	6.1 ^{e)}	DTS Matrix decoder
DTS-ES Discrete 6.1 ^{d)}	6.1 ^{e)}	DTS Discrete decoder
Dolby Digital EX ^{b)}	7.1	Matrix decoder conforms to Dolby Pro Logic IIx

When you select “SB ON”

To decode the surround back signal regardless of the 6.1 channel decode flag^{a)}, Dolby Digital EX is applied when the output channel is 6.1 and Dolby Digital EX or Dolby Pro Logic IIx is applied when the output channel is 7.1.

Input stream	Output channel	Applied surround back decoder
Dolby Digital 5.1	6.1	Matrix decoder conforms to Dolby Digital EX
Dolby Digital EX ^{b)}	6.1	Matrix decoder conforms to Dolby Digital EX
DTS 5.1	6.1 ^{e)}	Matrix decoder conforms to Dolby Digital EX
DTS-ES Matrix 6.1 ^{c)}	6.1 ^{e)}	Matrix decoder conforms to Dolby Digital EX
DTS-ES Discrete 6.1 ^{d)}	6.1 ^{e)}	Matrix decoder conforms to Dolby Digital EX
Dolby Digital 5.1	7.1	Matrix decoder conforms to Dolby Pro Logic IIx
Dolby Digital EX ^{b)}	7.1	Matrix decoder conforms to Dolby Pro Logic IIx

When you select “SB OFF”

Surround back decoding is not performed.

- a) 6.1 channel decode flag is the information recorded in software like DVDs.
- b) Dolby Digital DVD that includes a Surround EX flag. The Dolby Corporation web page can help you distinguish Surround EX films.
- c) Software encoded with a flag to denote it has both Surround EX and 5.1 channel signals.
- d) Software encoded with both 5.1 channel signals and an extension stream designed for returning those signals to 6.1 discrete channels. Discrete 6.1 channel signals are DVD specific signals not used in movie theaters.
- e) When two surround back speakers are connected, the output channel will be 7.1 channels.

Note

There may be no sound from the surround back speaker in Dolby Digital EX mode. Some discs have no Dolby Digital EX flag even though the packages have Dolby Digital EX logos. In this case, select “SB ON”.

Assigning the component video input

— COMPONENT VIDEO INPUT ASSIGN

You can assign a component video input for another visual input.

- 1** Press MAIN MENU repeatedly to select “CUSTOM”.
- 2** Turn MENU to select “COMP. V. A.”.
- 3** Press MEMORY/ENTER.
- 4** Turn MENU to select the component video input you want to assign.
- 5** Turn -/+ to select the visual input you want to assign the component video input jacks selected in step 4.

The input you can assign varies for each component video input. For details, see “Selectable visual inputs for each component video input”.

Selectable visual inputs for each component video input

The initial setting is underlined.

(Assignable component video inputs)	Display
Selectable visual inputs	
(DVD)	
VIDEO 1	DVD- VD1
VIDEO 2	DVD- VD2
VIDEO 3	DVD- VD3
DVD	<u>DVD- DVD</u>
(TV/SAT)	
VIDEO 1	TV - VD1
VIDEO 2	TV - VD2
VIDEO 3	TV - VD3
TV/SAT	<u>TV - TV</u>

Note

You cannot assign a visual input to more than one component video input.

Switching the audio input mode for digital components

— INPUT MODE

You can switch the audio input mode for components which have digital audio input jacks.

- 1** Turn INPUT SELECTOR to select the input.
- 2** Press INPUT MODE repeatedly to select the audio input mode.

The selected audio input mode appears in the display.

Audio input modes

■ AUTO IN (AUTO 2CH)

Gives priority to digital signals when there are both digital and analog connections. If there are no digital signals, analog is selected.

■ COAX IN (COAX FIXED)

Specifies the digital audio signals input to the DIGITAL COAXIAL input jack.

■ OPT IN (OPT FIXED)

Specifies the digital audio signals input to the DIGITAL OPTICAL input jacks.

■ ANALOG (ANALOG FIXED)

Specifies the analog audio signals input to the AUDIO IN (L/R) jacks.

Notes

- When signals with a sampling frequency of more than 48 kHz is input, the equalizer and sound field cannot be used.
- Some audio input modes may be dimmed depending on the input. This means that the selected input is unavailable.

Customizing sound fields

By adjusting the LEVEL menu, you can customize the sound fields to suit your particular listening situation.

Note on the displayed items

The setup items you can adjust in each menu vary depending on the sound field. Certain setup parameters may be dimmed in the display. This means that the selected parameter is either unavailable or fixed and unchangeable.

Adjusting the LEVEL menu parameters

You can adjust the balance and level of each speaker. These settings are applied to all sound fields except for effect level parameter. The effect level parameter settings are stored individually for each sound field.

- 1 Start playing a source encoded with multi channel surround effects (DVD, etc.).**
- 2 Press MAIN MENU repeatedly to select "LEVEL".**
- 3 Turn MENU to select the parameter you want to adjust.**
For details, see "LEVEL menu parameters" below.
- 4 While monitoring the sound, turn -/+ to select the setting you want.**
The setting is entered automatically.
- 5 Repeat steps 3 and 4 to adjust the other parameters.**

LEVEL menu parameters

■ T. TONE (Test Tone)

Initial setting: Off (T. TONE)

Lets you output the test tone sequentially from each speaker. When set to "AUTO XXX", the test tone is output from each speaker automatically. When set to "FIX XXX", you can select which speaker will output the test tone.

■ BAL. L/R XXX (Front speaker balance)

Initial setting: 0 (BALANCE)

Lets you adjust the balance between front left and right speakers. You can adjust in the range of BAL. L (+1 to +16), BALANCE (0), BAL. R (+1 to +16) in 33 steps.

■ CTR XXX.X dB (Center speaker level)

■ SUR.L. XXX.X dB (Surround speaker (left) level)

■ SUR.R. XXX.X dB (Surround speaker (right) level)

■ SB XXX.X dB (Surround back speaker level)*

■ SBL XXX.X dB (Surround back speaker (left) level)**

■ SBR XXX.X dB (Surround back speaker (right) level)**

■ S.W. XXX.X dB (Sub woofer level)

Initial setting: 0 dB

You can adjust from -20 dB to +10 dB in 0.5 dB steps.

* Only when the surround back speaker selection parameter is set to "SINGLE" in the SPEAKER SETUP menu (page 18).

** Only when the surround back speaker selection parameter is set to "DUAL" in the SPEAKER SETUP menu (page 18).

■ S.W. XXX dB (Multi channel sub woofer level)

Initial setting: 0 dB

Lets you increase the level of the MULTI CH IN sub woofer channel by +10 dB. This adjustment may be necessary when connecting a DVD player to the MULTI CH IN jacks. The sub woofer level from DVD player is 10 dB lower than Super Audio CD player.

■ EFCT. XXX (Effect level)

Initial setting: STD

Lets you adjust the "presence" of the surround effect in 3 levels – MIN (minimum effect), STD (standard effect) and MAX (maximum effect).

Note

This parameter is valid only when you use a sound field selected with the MOVIE or MUSIC buttons.

For advanced LEVEL menu adjustments

Set “MENU XXX” in the CUSTOMIZE menu to “MENU EXP.” (page 40). This enables advanced setups including those of phase noise, phase audio and dynamic range compressor. For details on how to set the items, see page 43.

Resetting sound fields to the initial settings

Use the buttons on the receiver for the operation.

- 1** Press I/⏻ to turn off the power.
- 2** While holding down 2CH, press I/⏻. “SF. CLR.” appears in the display and all sound fields are reset to the initial setting.

Adjusting the equalizer

You can adjust the tonal quality (bass, treble level) of the front speakers using the EQUALIZER menu.

- 1** Start playing a source encoded with multi channel surround effects (DVD, etc.).
- 2** Press MAIN MENU repeatedly to select “E Q”.
- 3** Turn MENU to select the parameter you want to adjust.
For details, see “EQUALIZER menu parameters” below.
- 4** While monitoring the sound, turn -/+ to select the setting you want.
The setting is entered automatically.
- 5** Repeat steps 3 and 4 to adjust the other items.

Note

You cannot adjust the equalizer when the receiver is decoding signals with a sampling frequency of more than 48 kHz, or when DTS 96/24, DTS-ES Matrix or DTS Neo:6 decoding is applied.

EQUALIZER menu parameters

■ EQ XXX (Equalizer on/off)

Initial setting: OFF

Select “ON” to activate the equalizer.

Note

The “EQ” indicator lights up in the display when the equalizer is turned on. When you adjust the equalizer using the EQUALIZER menu parameters, the settings are applied to all sound fields and can be reproduced whenever you turn on the equalizer.

■ BASS XXX dB (Front speaker bass level)

■ TREB. XXX dB (Front speaker treble level)

Initial setting: 0 dB

You can adjust from -10 dB to +10 dB in 1 dB steps.

Advanced settings

Using the CUSTOMIZE menu to adjust the receiver

You can adjust various receiver settings using the CUSTOMIZE menu.

- 1 Press MAIN MENU repeatedly to select “CUSTOM”.**
- 2 Turn MENU to select the parameter you want to adjust.**
For details, see “CUSTOMIZE menu parameters” below.
- 3 Turn -/+ to select the setting you want.**
The setting is entered automatically.
- 4 Repeat steps 2 and 3 to adjust the other items.**

CUSTOMIZE menu parameters

The initial setting is underlined.

■ MENU XXX (Menu expanding)

- EXP.

The advanced parameters for the SPEAKER SETUP and LEVEL menus are displayed and can be adjusted. For details on each setup item, see pages 17, 38 and the following pages.

- STD

The advanced parameters for SPEAKER SETUP and LEVEL menus are not displayed.

■ 96 XXXX

(DTS 96/24 decoding mode)

- AUTO

When a DTS 96/24 signal is input, it is played back at 96 kHz sampling frequencies.

- OFF

Even when a DTS 96/24 signal is input, it is played back at 48 kHz sampling frequencies.

Notes

- This parameter is valid only in A.F.D. mode (page 31). In other sound fields, this parameter is automatically set to “OFF”.
- Even when a DTS 96/24 signal is input, standard 48 kHz decoding is used if any speakers are set to “SMALL” or if the sub woofer is set to “NO”.

■ SB XXXX

(Surround back decoding mode)

You can also press SURR BACK DECODING to select the surround back decoding mode (page 35). For details on each decoding mode, see page 36.

- OFF
- AUTO
- ON

Note

This parameter is valid only when A.F.D. mode is selected except for Dolby Pro Logic IIX mode (page 31).

■ S.F XXXX (Sound field link)

- LINK

Lets you apply the last selected sound field to an input whenever it is selected. For example, if you select HALL for the SA-CD/CD input, then change to a different input and return to SA-CD/CD, HALL will automatically be applied again.

- FIX

Sound field link is not activated.

■ A.V.SYNC.XX

(Time alignment)

Initial setting: 0 (0 ms)

Lets you delay the output of audio to adjust the gap between video and audio. You can adjust from 0 (0 ms) to 20 (200 ms) in 10 ms steps.

■ DEC. XXXX

(Digital audio input decoding priority)

Lets you specify the input mode for the digital signal input to the DIGITAL IN jacks.

The initial setting is “DEC. AUTO” for VIDEO 3 and TV/SAT, and “DEC. PCM” for DVD, MD/TAPE and SA-CD/CD.

- AUTO

Automatically switches the input mode between DTS, Dolby Digital, or PCM.

- PCM

PCM signals are given priority (to prevent the interruption when playback starts). Even when other signals are input, the sound is output. However, this receiver cannot decode DTS-CD when set to “DEC. PCM”.

Note

When set to “DEC. AUTO” and the sound from the digital audio jacks (for SA-CD/CD, etc.) is interrupted when playback starts, set to “DEC. PCM”.

■ D.PWR XXX (Digital power management)

• OFF

Lets you turn off the power of the unnecessary digital circuits automatically when outputting the analog audio signals using the ANALOG DIRECT or MULTI CH IN function. You can enjoy high quality analog audio without the influence of digital circuits.

• ON

Lets you keep the power of digital circuits on. Select if you do not like the time lag that occurs with the "D.PWR OFF" setting.

■ DUAL XXX (Digital broadcast language selection)

Lets you select the language you want to listen to during digital broadcast. This feature only functions for Dolby Digital sources.

• M/S (Main/Sub)

Sound of the main language will be output through the front left speaker and sound of the sub language will be output through the front right speaker simultaneously.

• M (Main)

Sound of the main language will be output.

• S (Sub)

Sound of the sub language will be output.

• M+S (Main + Sub)

Mixed sound of both the main and sub languages will be output.

■ COMP. V. A. (Component video input assignment)

Lets you assign the component video input to another visual input. For details, see "Assigning the component video input" on page 37.

■ [DIMMER] (Brightness of the display)

Lets you adjust the brightness of the display in 3 steps.

■ NAME IN (Naming preset stations and inputs)

Lets you set the name of preset stations and inputs selected with INPUT SELECTOR. For details, see "Naming preset stations and inputs" on page 44.

Advanced SPEAKER SETUP menu parameters

When "MENU XXX" is set to "MENU EXP.", the following parameters are displayed and adjustable in addition to the SPEAKER SETUP menu parameters on page 17.

The initial setting is underlined.

■ DISTANCE (Distance unit)

Lets you select the unit of measure for setting distances.

• ft.

The distance is displayed in feet.

• m

The distance is displayed in meters.

■ PL. XXXX (Surround speaker position)*

Lets you specify the location of your surround speakers for proper implementation of the surround effects in the Cinema Studio EX modes (page 33).

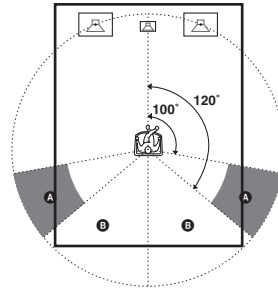

• SIDE

Select if the location of your surround speakers corresponds to section **A**.

• BEHD

Select if the location of your surround speakers corresponds to section **B**.

* This setup item is not available when the surround speaker size parameter is set to "NO".

Tip

Surround speaker position is designed specifically for implementation of the Cinema Studio EX modes.

For other sound fields, speaker position is not so critical. Those sound fields were designed under the premise that the surround speakers would be located behind the listening position, but presentation remains fairly consistent even with the surround speakers positioned at a rather wide angle. However, if the speakers are pointing toward the listener from the immediate left and right of the listening position, the surround effects becomes unclear unless set to "PL. SIDE".

Nevertheless, each listening environment has many variables, like wall reflections, and you may obtain better results using "PL. BEHD" if your speakers are located high above the listening position, even if they are to the immediate left and right.

Therefore, although it may result in a setting contrary to the above explanation, we recommend that you playback multi channel surround encoded software and select the setting that provides a good sense of spaciousness and that best succeeds in forming a cohesive space between the surround sound from the surround speakers and the sound of the front speakers. If you are not sure which sounds best, select "PL. BEHD" and then use the speaker distance parameter and speaker level adjustments to obtain proper balance.

■ HGT. XXXX (Surround speaker height)*

Lets you specify the height of your surround speakers for proper implementation of the surround effects of the Cinema Studio EX modes (page 33).

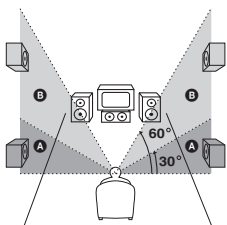

- **LOW**
Select if the height of your surround speakers corresponds to section **A**.
- **HIGH**
Select if the height of your surround speakers corresponds to section **B**.

* This setup item is not available when the surround speaker size parameter is set to "NO".

■ SP > XXX Hz (Speaker crossover frequency)*

Initial setting: 100 Hz

Lets you adjust the bass crossover frequency of speakers in SPEAKER SETUP menu. You can adjust the bass crossover frequency from 40 Hz to 160 Hz in 10 Hz steps.

* This setup item is only available when at least one speaker is set to "SMALL" and the corresponding speaker segment flashes in the display.

Advanced LEVEL menu parameters

When “MENU XXX” is set to “MENU EXP.”, the following parameters are displayed and adjustable in addition to the LEVEL menu parameters on page 38.

The initial setting is underlined.

■ P. NOISE (Phase noise)

Initial setting: Off

Lets you output the test tone sequentially from two adjacent speakers.

■ P. AUDIO (Phase audio)

Initial setting: Off

Lets you output the front 2 channel source sound (instead of the test tone) sequentially from adjacent speakers.

■ COMP. XXX (Dynamic range compressor)

Lets you compress the dynamic range of the sound track. This may be useful when you want to watch movies at low volumes late at night.

- OFF

The dynamic range is not compressed.

- STD

The dynamic range is compressed as intended by the recording engineer.

- MAX

The dynamic range is compressed dramatically.

Tip

Dynamic range compressor lets you compress the dynamic range of the soundtrack based on the dynamic range information included in the Dolby Digital signal. “COMP. STD” is the standard setting, but it only enacts light compression. Therefore, we recommend using the “COMP. MAX” setting. This greatly compresses the dynamic range and lets you view movies late at night at low volumes. Unlike analog limiters, the levels are predetermined and provide a very natural compression.

Note

Dynamic range compression is possible with Dolby Digital sources only.

Other Operations

Naming preset stations and inputs

You can enter a name of up to 8 characters for preset stations and inputs selected with INPUT SELECTOR, and display it in the receiver's display.

Use the buttons on the receiver for the operation.

1 To index a preset station

Turn INPUT SELECTOR to select the FM or AM band, then tune in the preset station you want to create an index name for (page 25). Then, press MAIN MENU repeatedly to select "TUNER".

To index an input

Turn INPUT SELECTOR to select the input you want to create an index name for. Then, press MAIN MENU repeatedly to select "CUSTOM".

2 Turn MENU to select "NAME IN".

3 Press MEMORY/ENTER.

The cursor flashes and you can select a character.

4 Use MENU and -/+ to create an index name.

Turn -/+ to select a character, then turn MENU to move the cursor to the next position.

Tips

- You can select the character type as follows by turning -/+.
Alphabet (upper case) → Numbers → Symbols
- To enter a blank space, turn -/+ until a blank space appears in the display.
- If you made a mistake, turn MENU until the character you want to change flashes, then turn -/+ to select the correct character.

5 Press MEMORY/ENTER to store the index name.

Note (Models of area code CEL, CEK only)

When you name an RDS station and tune in the station, the Program Service name appears instead of the name you entered. (You cannot change the name of a Program Service name. The name you entered will be overwritten by the Program Service name.)

Changing the command mode of the receiver

This function is useful when you use 2 Sony receivers in the same room.

- 1 Turn off the receiver.**
- 2 Hold down INPUT MODE and press I/⏻ to turn on the receiver.**

“C.MODE.AVX” appears in the display.
Each time you repeat the procedure above, the display changes as follows:
C.MODE.AV1 ↔ C.MODE.AV2

Tip

The initial setting is “C.MODE.AV2”.

Notes

- The initial setting for the command mode of the supplied remote is “AV2”.
- If the command mode of the receiver and the remote is different, you cannot use the remote to operate the receiver.

Using the Sleep Timer

You can set the receiver to turn off automatically at a specified time.

Use the remote for the operation.

- 1 Press ALT to light up the button.**
- 2 Press SLEEP repeatedly while the power is on.**

Each time you press SLEEP, the display changes cyclically as follows:

2-00-00 → 1-30-00 → 1-00-00 →
0-30-00 → OFF

While using Sleep Timer, “SLEEP” lights up in the display.

Tip

To check the remaining time before the receiver turns off, press ALT to light up the button (page 49), then press SLEEP. The remaining time appears in the display. If you press SLEEP again, the sleep timer will be canceled.

Selecting the speaker system

You can select the front speaker system you want to use.

Press SPEAKERS (OFF/A/B/A+B) repeatedly to select the front speaker system you want to use.

The selected speaker system indicator lights up in the display. To turn off the speaker output, press SPEAKERS (OFF/A/B/A+B) repeatedly until “SP A” and “SP B” indications in the display turn off.

To select	Indicator lights up in the display
The speaker connected to the SPEAKERS FRONT A terminals.	SP A
The speaker connected to the SPEAKERS FRONT B terminals.	SP B
The speakers connected to both the SPEAKERS FRONT A and B terminals (parallel connection).*	SP A and SP B

* (Except for models of area code CEK)

When the IMPEDANCE SELECTOR is set to “8Ω”, connect the speakers with a nominal impedance of 16 ohms or higher. When the IMPEDANCE SELECTOR is set to “4Ω”, connect the speakers with a nominal impedance of 8 ohms or higher. For details, see “Speaker impedance” on page 14.

(Models of area code CEK only)

If you connect speakers to both SPEAKERS FRONT A and B terminals, connect the speakers with a nominal impedance of 16 ohms or higher.

Recording

Before you begin, make sure you have connected all components properly.

Recording on an audio tape or MiniDisc

You can record on a cassette tape or MiniDisc using the receiver. See the operating instructions of your cassette deck or MD deck if you need help.

- 1 Select the component to be recorded.**
- 2 Prepare the component for playing.**
For example, insert a CD into the CD player.
- 3 Insert a blank tape or MiniDisc into the recording deck and adjust the recording level, if necessary.**
- 4 Start recording on the recording deck, then start playback on the playback component.**

Notes

- You cannot record a digital audio signal using a component connected to the analog MD/TAPE OUT jacks. To record a digital audio signal, connect a digital component to the DIGITAL OPTICAL MD/TAPE OUT jack.
- Sound adjustments do not affect the signal output from the MD/TAPE OUT jacks.
- The analog audio signals of the current input is output from the MD/TAPE OUT jacks.
- The signals input to the MULTI CH IN jacks are not output from the MD/TAPE OUT jacks even when MULTI CH IN is being used. The analog audio signals of the current or previously used input are output.
- No signals are output from DIGITAL OPTICAL MD/TAPE OUT jack when ANALOG DIRECT function is being used. The digital circuitry power is cut off to ensure superior sound quality when “D.PWR XXX” is set to “D.PWR OFF”.
- Some sources contain copy guards to prevent recording. In this case, you may not be able to record from the sources.

Recording on a video tape

You can record from a VCR, a TV or a DVD player using the receiver. You can also add audio from a variety of audio sources when editing a video tape. See the operating instructions of your VCR or DVD player if you need help.

- 1 Select the program source to be recorded.**
- 2 Prepare the component for playing.**
For example, insert a video tape you want to record into VCR.
- 3 Insert a blank video tape into the VCR (VIDEO 1 or VIDEO 2) for recording.**
- 4 Start recording on the recording VCR, then start playing the video tape or DVD you want to record.**

Notes

- You cannot record a digital audio signal using a component connected to the analog VIDEO 1 AUDIO OUT or VIDEO 2 AUDIO OUT jacks.
- Make sure to make both digital and analog connections to the TV/SAT and DVD inputs. Analog recording is not possible if you make only digital connections.
- The analog audio signals of the current input are output from the VIDEO 1 AUDIO OUT or VIDEO 2 AUDIO OUT jacks.
- The signals input to the MULTI CH IN jacks are not output from VIDEO 1 AUDIO OUT or VIDEO 2 AUDIO OUT jacks even when MULTI CH IN is being used. The analog audio signals of the current or previously used input are output.

Operations Using the Remote RM-AAP002

You can use the remote RM-AAP002 to operate the components in your system.

Before you use your remote

Inserting batteries into the remote

Insert R6 (size-AA) batteries with the + and – properly oriented in the battery compartment. When using the remote, point it at the remote sensor  on the receiver.

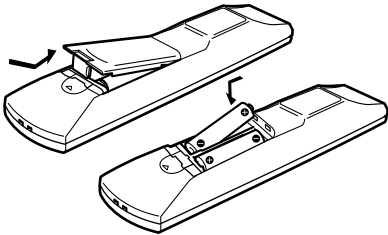

Tip

Under normal conditions, the batteries should last for about 6 months. When the remote no longer operates the receiver, replace all batteries with new ones.

Notes

- Do not leave the remote in an extremely hot or humid place.
- Do not use a new battery with an old one.
- Do not expose the remote sensor to direct sunlight or lighting apparatuses. Doing so may cause a malfunction.
- If you do not use the remote for an extended period of time, remove the batteries to avoid possible damage from battery leakage and corrosion.

Remote button description

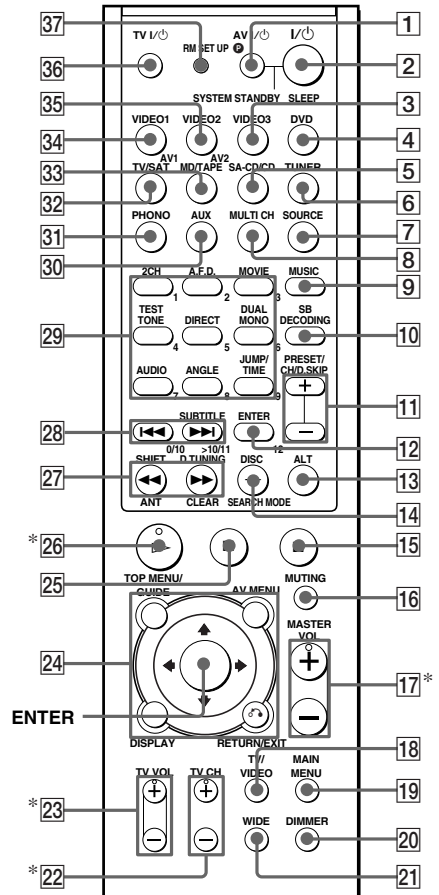

* The , TV VOL +, TV CH + and MASTER VOL + buttons have a tactile dot. Use the tactile dot as a reference when operating the receiver and other audio/video components.

The tables below show the settings of each button.

Remote Button	Operations	Function
A.F.D. 29	Receiver	Selects the decoding mode for audio sound.
ALT 13	Remote	When ALT button lights up, it changes remote key function to activate those buttons with orange printing.
ANGLE 29	DVD player/ Blu-ray disc recorder	Selects viewing angle or changes the angles.
ANT 27	VCR/ Satellite tuner	Selects output signal from the antenna terminal: TV signal or VCR program.
AUDIO 29	TV/VCR/ Satellite tuner/ DVD player/ Blu-ray disc recorder/ Hard disc recorder/PSX	Changes the sound to Multiplex, Bilingual or Multi channel TV Sound.
AUX 30	Receiver	To listen to an audio equipment.
AV MENU 24	VCR/ Satellite tuner/ DVD player/ Blu-ray disc recorder/ Hard disc recorder/PSX	Displays menu.
AV 1 34 and AV 2 35	Remote	Select the command mode of the remote.
AV I/ 1	TV/VCR/ Satellite tuner/ CD player/ VCD player/ LD player/ DVD player/ MD deck/ DAT deck/ Blu-ray disc recorder/ Hard disc recorder/PSX	Turns the audio and video components on or off.

Remote Button	Operations	Function
CLEAR 27	Satellite tuner/ CD player/ DVD player/ Blu-ray disc recorder/PSX	Clears a mistake when you press the incorrect numeric buttons or returns to continuous playback etc.
DIMMER 20	Receiver	Adjusts the brightness of the display.
DIRECT 29	Receiver	Selects ANALOG DIRECT.
DISC 14	CD player/ VCD player	Selects a disc directly (multi-disc changer only).
DISPLAY 24	Receiver/ TV/VCR/ Satellite tuner/ CD player/ VCD player/ LD player/ DVD player/ MD deck/ Blu-ray disc recorder/ Hard disc recorder/PSX	Selects information displayed on the TV screen.
D.TUNING 27	Receiver	Enters direct tuning mode.
DUAL MONO 29	Receiver	Selects the language you want during digital broadcast.
DVD 4	Receiver	To watch DVD.
ENTER 24	Receiver/ VCR/ Satellite tuner/ DVD player/ Blu-ray disc recorder/ Hard disc recorder/PSX	Enters the selection.
ENTER 12	TV/VCR/ Satellite tuner/ LD player/ MD deck/ DAT deck/ Tape deck/ Blu-ray disc recorder/ Hard disc recorder/PSX	After selecting a channel, disc or track using the numeric buttons, press to enter the value.

Remote Button	Operations	Function
JUMP/TIME 29	Satellite tuner	Toggles between the previous and the current channels.
	CD player/ VCD player/ DVD player/ MD deck/ Blu-ray disc recorder	Shows the time or displays the playing time of disc, etc.
MAIN MENU 19	Receiver	Selects the menu of the receiver.
MASTER VOL +/- 17	Receiver	Adjusts the master volume of the receiver.
MD/TAPE 33	Receiver	To listen to Minidisc or audio tape.
MOVIE 29	Receiver	Selects the pre-programmed sound fields for movie.
MULTI CH 8	Receiver	Selects MULTI CH IN source.
MUSIC 9	Receiver	Selects the pre-programmed sound fields for music.
MUTING 16	Receiver	Mutes the sound from the receiver.
PHONO 31	Receiver	To listen to turntable.
PRESET/	Receiver	Selects preset stations.
CH/ D.SKIP +/- 11	TV/VCR/ Satellite tuner/ Blu-ray disc recorder/Hard disc recorder	Selects preset channels.
	CD player/ VCD player/ LD player/ DVD player/ MD deck	Skips discs (multi-disc changer only).
RETURN/ EXIT 24	VCD player/ LD player/ DVD player	Returns to the previous menu.
	Satellite tuner	Exits the menu.
RM SET UP 37	Remote	To set up the remote.
SA-CD/CD 5	Receiver	To listen to Super Audio CD or compact disc.

Remote Button	Operations	Function
SB DECODING 10	Receiver	Selects the surround back decoding modes.
SEARCH MODE 14	DVD player	Selects searching mode. Press to select the unit for search (track, index, etc.)
SHIFT 27	Receiver	Selects a memory page for presetting radio stations or tuning to preset stations.
SLEEP 2	Receiver	Activates the sleep function and the duration which the receiver turns off automatically.
SOURCE 7	Remote	Selects 2ND ZONE output.
SUBTITLE 28	DVD player	Changes the subtitles.
SYSTEM STANDBY (Press AV I/⏻ 1 and I/⏻ 2 at the same time)	Receiver/ TV/VCR/ Satellite tuner/ CD player/ VCD player/ LD player/ DVD player/ MD deck/ DAT deck	Turns off the receiver and other Sony audio/video components.
TEST TONE 29	Receiver	Outputs test tone.
TOP MENU/ GUIDE 24	DVD player	Displays DVD title.
	Satellite tuner/ Blu-ray disc recorder/ Hard disc recorder/PSX	Displays guide menu.
TUNER 6	Receiver	To listen to radio programs.
TV CH +/- 22	TV	Selects preset TV channels.
TV/SAT 32	Receiver	To watch TV programs or satellite receiver.
TV/VIDEO 18	TV	Selects input signal: TV input or video input.
TV VOL +/- 23	TV	Adjusts the volume of the TV.
TV I/⏻ 36	TV	Turns the TV on or off.

Remote Button	Operations	Function
VIDEO1 [34]	Receiver	To watch VCR. (VTR mode 3)
VIDEO2 [35]	Receiver	To watch VCR. (VTR mode 1)
VIDEO3 [3]	Receiver	To watch VCR. (VTR mode 2)
WIDE [21]	TV	Selects the wide picture mode.
I/⏻ [2]	Receiver	Turns the receiver on or off.
2CH [29]	Receiver	Selects 2CH STEREO mode.
1-9 [29] and 0/10 [28]	Receiver	Use with SHIFT to preset radio station or tuning to preset stations and with D.TUNING for direct tuning.
	CD player/ VCD player/ DVD player/ LD player/ MD deck/ DAT deck/ Tape deck	Selects track numbers. 0/10 selects track 10.
	TV/VCR/ Satellite tuner/ Blu-ray disc recorder/ Hard disc recorder/PSX	Selects channel numbers.
>10/11 [28]	CD player/ VCD player/ LD player/ MD deck/ Tape deck	Selects track numbers over 10.
	TV/VCR/ Satellite tuner/ Blu-ray disc recorder/ Hard disc recorder/PSX	Selects channel numbers over 10 or selects number 11.

Remote Button	Operations	Function
⏮/⏭ [28]	VCR/ CD player/ VCD player/ DVD player/ LD player/ MD deck/ DAT deck/ Tape deck/ Blu-ray disc recorder/ Hard disc recorder/PSX	Skips tracks.
⏮/⏭ [27]	CD player/ VCD player/ DVD player/ LD player/ MD deck/ Blu-ray disc recorder/ Hard disc recorder/PSX	Searches tracks in the forward or backward direction.
	VCR/ DAT deck/ Tape deck	Fastforwards or rewinds.
▶ [26]	VCR/ CD player/ VCD player/ LD player/ DVD player/ MD deck/ DAT deck/ Tape deck/ Blu-ray disc recorder/ Hard disc recorder/PSX	Starts playback.
⏸ [25]	VCR/ CD player/ VCD player/ LD player/ DVD player/ MD deck/ DAT deck/ Tape deck/ Blu-ray disc recorder/ Hard disc recorder/PSX	Pauses playback or record. (Also start recording with components in record standby.)

Remote Button	Operations	Function
■ 15	VCR/ CD player/ VCD player/ LD player/ DVD player/ MD deck/ DAT deck/ Tape deck/ Blu-ray disc recorder/ Hard disc recorder/PSX	Stops playback.
🔊 24	Satellite tuner/ VCD player/ LD player/ DVD player/ Blu-ray disc recorder/ Hard disc recorder/PSX	Returns to the previous menu or exits the menu.
⬆️/⬇️ 24	Receiver	Selects a menu item.
⬅️/➡️ 24	Receiver	Adjusts or changes the setting.
⬆️/⬇️/⬅️/➡️ 24	VCR/ Satellite tuner/ DVD player/ Blu-ray disc recorder/ Hard disc recorder/PSX	Selects a menu item.
-/-- 14	TV/ Satellite tuner/ Blu-ray disc recorder/ Hard disc recorder/PSX	Selects the channel entry mode, either one or two digit.

Notes

- The 12, AUX and SOURCE buttons on the remote are not available for receiver operation.
- Some functions explained in this section may not work depending on the model.
- The above explanation is intended to serve as an example only. Therefore, depending on the component the above operation may not be possible or may operate differently than described.
- When you press input buttons (VIDEO1, VIDEO2, VIDEO3, TV/SAT or DVD), the input mode of the TV might not switch to the corresponding input mode that you want. In this case, press TV/VIDEO button to switch the input mode of the TV.

Tips

- You need to assign a component to the AUX and MULTI CH buttons before you can use the buttons to control your audio/video equipment. For details, refer “Programming the remote” on page 53.
- To activate the buttons with orange printing, press ALT first before pressing the buttons.
- Before you use the ⬆️/⬇️/⬅️/➡️ buttons for receiver operation, press MAIN MENU. To operate other components, press TOP MENU/GUIDE or AV MENU after pressing the input button.

Selecting the command mode of the remote

Set the remote command mode using the RM SET UP button and the remote command mode buttons.

Use a suitable tool to press the RM SET UP button.

Selecting the command mode

You can switch the command mode (AV1 and AV2) of the remote. If the command mode of the receiver and the remote is different, you cannot use the remote to operate the receiver. To change the command mode of the receiver, see page 45.

Press AV1 (or AV2) while holding down RM SET UP.

The indicator flashes once (twice for AV2), then the command mode switches.

To check the command mode of the remote

Press RM SET UP. You can check the remote by the indicator.

Mode	Indicator flashes
AV1	once
AV2	twice

To reset the remote to factory settings

Press I/⏻, AV I/⏻ and MASTER VOL – at the same time.

The indicator flashes 3 times, then goes off.

Programming the remote

You can program the remote to control non-Sony components by changing the code. Once the control signals have been memorized, you can use those components as part of your system.

Furthermore, you can also program the remote for Sony components that the remote is unable to control. Note that the remote can only control components that accept infrared wireless control signals.

1 Press AV I/⏻ while holding down RM SET UP.

The indicator lights up.

2 Press the input button (including TV I/⏻) for the component you want to control.

For example, if you are going to control a CD player, press SA-CD/CD.

3 Press the numeric buttons to enter the numeric code (or one of the codes if more than one code exists) corresponding to the component and the maker of the component you want to control.

See the tables on pages 54–56 for information on the numeric code(s) corresponding to the component and the maker of the component (the first digit and the last two digits of the numeric code correspond to the category and the maker's code respectively.)

4 Press ENTER.

Once the numeric code has been verified, the indicator slowly flashes twice and the remote automatically exits the programming mode.

5 Repeat steps 1 to 4 to control other components.

To cancel programming

Press RM SET UP during any step. The remote automatically exits the programming mode.

To activate the input after programming

Press the programmed button to activate the input you want.

If programming is unsuccessful, check the following:

- If the indicator does not light up in step 1, the batteries are weak. Replace both batteries.
- If the indicator flashes 4 times in quick succession while entering the numeric code, an error has occurred. Start again from step 1.

Notes

- The indicator turns off while a valid button is pressed.
- In step 2, if several input buttons are pressed, only the last pressed button is valid.
- In step 2, if you press TV I/⏪, only TV VOL +/-, TV CH +/-, TV/VIDEO and WIDE buttons are reprogrammed.
- In step 3, if an input button is pressed, the new input is selected and the programming procedure returns to the beginning of step 3.
- For the numeric codes, only the first three numbers entered are valid.

To clear the memory of the remote

To clear all programmes, do the following to reset the remote to factory settings.

Press I/⏪, AV I/⏪ and MASTER VOL – at the same time.

The indicator flashes 3 times, then goes off.

The numeric codes corresponding to the component and the maker of the component

Use the numeric codes in the tables below to control non-Sony components and also Sony components that the remote is normally unable to control. Since the remote signal that a component accepts differs depending on the model and year of the component, more than one numeric code may be assigned to a component. If you fail to program your remote using one of the codes, try using other codes.

Notes

- The numeric codes are based on the latest information available for each brand. There is a chance, however, that your component will not respond to some or all of the codes.
- All of the input buttons on this remote may not be available when used with your particular component.

To control a CD player

Maker	Code(s)
SONY	101, 102, 103
DENON	104, 123
JVC	105, 106, 107
KENWOOD	108, 109, 110
MAGNAVOX	111, 116
MARANTZ	116
ONKYO	112, 113, 114
PANASONIC	115
PHILIPS	116
PIONEER	117
TECHNICS	115, 118, 119
YAMAHA	120, 121, 122

To control a DAT deck

Maker	Code(s)
SONY	203
PIONEER	219

To control an MD deck

Maker	Code(s)
SONY	301
DENON	302
JVC	303
KENWOOD	304

To control a tape deck

Maker	Code(s)
SONY	201, 202
DENON	204, 205
KENWOOD	206, 207, 208, 209
NAKAMICHI	210
PANASONIC	216
PHILIPS	211, 212
PIONEER	213, 214
TECHNICS	215, 216
YAMAHA	217, 218

To control an LD player

Maker	Code(s)
SONY	601, 602, 603
PIONEER	606

To control a video CD player

Maker	Code(s)
SONY	605

To control a VCR

Maker	Code(s)
SONY	701, 702, 703, 704, 705, 706
AIWA*	710, 750, 757, 758
AKAI	707, 708, 709, 759
BLAUPUNKT	740
EMERSON	711, 712, 713, 714, 715, 716, 750
FISHER	717, 718, 719, 720
GENERAL ELECTRIC	721, 722, 730
GOLDSTAR	723, 753
GRUNDIG	724
HITACHI	722, 725, 729, 741
ITT/NOKIA	717
JVC	726, 727, 728, 736
MAGNAVOX	730, 731, 738
MITSUBISHI/MGA	732, 733, 734, 735
NEC	736
PANASONIC	729, 730, 737, 738, 739, 740
PHILIPS	729, 730, 731
PIONEER	729
RCA/PROSCAN	722, 729, 730, 731, 741, 747
SAMSUNG	742, 743, 744, 745
SANYO	717, 720, 746
SHARP	748, 749
TELEFUNKEN	751, 752
TOSHIBA	747, 755, 756
ZENITH	754

* If an AIWA VCR does not work even though you enter the code for AIWA, enter the code for Sony instead.

To control a DVD player

Maker	Code(s)
SONY	401, 402, 403
PANASONIC	406, 408
PHILIPS	407
PIONEER	409
TOSHIBA	404
DENON	405

To control a TV

Maker	Code(s)
SONY	501, 502
DAEWOO	504, 505, 506, 515, 544
FISHER	508
GOLDSTAR	503, 511, 512, 515, 534, 544
GRUNDIG	517, 534
HITACHI	513, 514, 515, 544
ITT/NOKIA	521, 522
JVC	516
MAGNAVOX	503, 518, 544
mitsubishi/MGA	503, 519, 544
NEC	503, 520, 544
PANASONIC	509, 524
PHILIPS	515, 518
PIONEER	509, 525, 526
RCA/PROSCAN	510, 527, 529, 544
SAMSUNG	503, 515, 531, 532, 533, 534, 544
SANYO	508, 545, 547
SHARP	535
TELEFUNKEN	523, 537, 547
THOMSON	530, 537, 547
TOSHIBA	535, 541
ZENITH	542, 543

To control a satellite tuner or cable box

Maker	Code(s)
SONY	801, 802, 803, 804
JERROLD/G.I.	806, 807, 808, 809, 810, 811, 812, 813, 814
PANASONIC	818
RCA	805, 819
S. ATLANTA	815, 816, 817

To control a tuner

Maker	Code(s)
SONY	002, 003, 004, 005

To control a hard disc recorder

Maker	Code(s)
SONY	307, 308, 309

To control a blu-ray disc recorder

Maker	Code(s)
SONY	310, 311, 312

To control a PSX

Maker	Code(s)
SONY	313, 314, 315

Precautions

On safety

Should any solid object or liquid fall into the cabinet, unplug the receiver and have it checked by qualified personnel before operating it any further.

On power sources

- Before operating the receiver, check that the operating voltage is identical with your local power supply. The operating voltage is indicated on the nameplate at the rear of the receiver.
- The receiver is not disconnected from the AC power source (mains) as long as it is connected to the wall outlet, even if the receiver itself has been turned off.
- If you are not going to use the receiver for a long time, be sure to disconnect the receiver from the wall outlet. To disconnect the AC power cord, grasp the plug itself; never pull the cord.
- AC power cord must be changed only at the qualified service shop.

On heat buildup

Although the receiver heats up during operation, this is not a malfunction. If you continuously use this receiver at a large volume, the cabinet temperature of the top, side and bottom rises considerably. To avoid burning yourself, do not touch the cabinet.

On placement

- Place the receiver in a location with adequate ventilation to prevent heat buildup and prolong the life of the receiver.
- Do not place the receiver near heat sources, or in a place subject to direct sunlight, excessive dust or mechanical shock.
- Do not place anything on top of the cabinet that might block the ventilation holes and cause malfunctions.
- Use caution when placing the receiver on surfaces that have been specially treated (with wax, oil, polish, etc.) as staining or discoloration of the surface may result.

On operation

Before connecting other components, be sure to turn off and unplug the receiver.

On cleaning

Clean the cabinet, panel and controls with a soft cloth slightly moistened with a mild detergent solution. Do not use any type of abrasive pad, scouring powder or solvent such as alcohol or benzine.

If you have any question or problem concerning your receiver, please consult your nearest Sony dealer.

Troubleshooting

If you experience any of the following difficulties while using the receiver, use this troubleshooting guide to help you remedy the problem.

There is no sound or only very low-level sound no matter which component is selected.

- Check that the speakers and components are connected securely and correctly.
- Check that both the receiver and all components are turned on.
- Check that you have selected the correct component on the receiver.
- Check that MASTER VOLUME $-/+$ is not set to “-oodB” (volume minimum).
- Check that the SPEAKERS (OFF/A/B/A+B) is not set to off (page 46).
- Check that the headphones are not connected.
- Press MUTING on the remote to cancel the muting function.

There is no sound from a specific component.

- Check that the component is connected correctly to the audio input jacks for that component.
- Check that the cord(s) used for the connection is (are) fully inserted into the jacks on both the receiver and the component.
- Check that you have selected the correct component on the receiver.

There is no sound from one of the front speakers.

- Connect a pair of headphones to the PHONES jack to verify that sound is output from the headphones. If only one channel is output from the headphones, the component may not be connected to the receiver correctly. Check that all the cords are fully inserted into the jacks on both the receiver and the component. If both channels are output from the headphones, the front speaker may not be connected to the receiver correctly. Check the connection of the front speaker which is not outputting any sound.

There is no sound from analog 2 channel sources.

- Check that the INPUT MODE is not set to “COAX IN” or “OPT IN” (page 37).
- Check that you have not selected MULTI CH IN function.

There is no sound from digital sources (from COAXIAL or OPTICAL input jack).

- Check that the INPUT MODE is not set to “ANALOG” (page 37). Check that the INPUT MODE is not set to “COAX IN” for the sources from OPTICAL input jack, or set to “OPT IN” for the sources from COAXIAL input jack.
- Check that you have not selected MULTI CH IN function.

The left and right sounds are unbalanced or reversed.

- Check that the speakers and components are connected correctly and securely.
- Adjust balance parameters in the LEVEL menu.

There is severe hum or noise.

- Check that the speakers and components are connected securely.
- Check that the connecting cords are away from a transformer or motor, and at least 3 meters away from a TV set or fluorescent light.
- Move your audio components away from the TV.
- Make sure you have grounded the SIGNAL GROUND terminal (only when a turntable is connected).
- The plugs and jacks are dirty. Wipe them with a cloth slightly moistened with alcohol.

There is no sound from the surround back speakers.

- Some discs have no Dolby Digital EX flag even though the packages have Dolby Digital EX logos. In this case, select “SB ON” (page 40).

There is no sound or only a very low-level sound is heard from the center/surround/surround back speakers.

- Select a CINEMA STUDIO EX mode (page 33).
- Adjust the speaker level (page 20).
- Make sure the center/surround speakers size parameter are set to either “SMALL” or “LARGE” (page 17 and 18).
- Make sure the surround back speaker selection parameter is set to either “DUAL” or “SINGLE” (page 18).

There is no sound from the sub woofer.

- Make sure you have turn on your sub woofer.
- Check that the sub woofer is connected correctly and securely.
- Make sure the sub woofer selection parameter is set to “YES” (page 17).
- There is no sound output from the sub woofer depending on the sound field.

The surround effect cannot be obtained.

- Make sure the sound field function is on (press MOVIE or MUSIC).
- Sound fields do not function for the signals with a sampling frequency of more than 48 kHz.

Dolby Digital or DTS multi channel sound is not reproduced.

- Check that the playing DVD, etc. is recorded in Dolby Digital or DTS format.
- When connecting the DVD player, etc. to the digital input jacks of this receiver, check the audio setting (settings for the audio output) of the connected component.

Recording cannot be done.

- Check that the components are connected correctly.
- Select the source component with INPUT SELECTOR.
- Make sure that INPUT MODE is set to "ANALOG" (page 37) before recording from a digital component connected to the analog MD/TAPE jacks.
- Make sure that INPUT MODE is set to "COAX IN" or "OPT IN" (page 37) before recording from a digital component connected to the DIGITAL OPTICAL MD/TAPE OUT jack.

The FM reception is poor.

- Use a 75-ohm coaxial cable (not supplied) to connect the receiver to an outdoor FM antenna as shown below. If you connect the receiver to an outdoor antenna, ground it against lightning. To prevent a gas explosion, do not connect the ground wire to a gas pipe.

Outdoor FM antenna

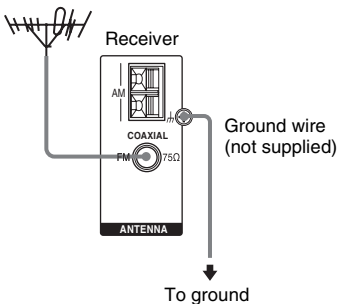
**Radio stations cannot be tuned in.**

- Check that the antennas are connected securely. Adjust the antennas and connect an external antenna if necessary.
- The signal strength of the stations is too weak (when tuning in with automatic tuning). Use direct tuning (page 24).
- Make sure you set the tuning interval correctly (when tuning in AM stations with direct tuning).
- No stations have been preset or the preset stations have been cleared (when tuning by scanning preset stations). Preset the stations (page 25).
- Press DISPLAY repeatedly so that the frequency appears in the display.

RDS does not work.*

- Make sure that you are tuned to an FM RDS station.
- Select a stronger FM station.

The RDS information that you want does not appear.*

- Contact the radio station and find out whether they actually provide the service in question. If so, the service may be temporarily out of order.

There is no picture or an unclear picture appears on the TV screen or monitor.

- Select the appropriate input on the receiver.
- Set your TV to the appropriate input mode.
- Move your audio components away from the TV.
- Connect your TV to the receiver using the same type of connecting cord as the one used to connect the receiver and video component (pages 7 and 10).





The DIGITAL OPTICAL MD/TAPE OUT jack flashes red.

- When "AUTO IN" is selected for INPUT MODE, the jack flashes red when no digital audio signal is input. This depends on the INPUT MODE function, and is not a malfunction.

* Models of area code CEL, CEK only.

Remote control

The remote does not function.

- The 12, AUX and SOURCE buttons on the remote are not available for receiver operation.
 - Point the remote at the remote sensor  on the receiver.
 - Remove any obstacles in the path between the remote and the receiver.
 - Replace all the batteries in the remote with new ones, if they are weak.
 - Check if the command modes of the receiver and the remote is the same. If the command mode of the receiver and the remote is different, you cannot operate the receiver with the remote. To switch the command mode of the receiver, press I/⏻ to turn off the power. Then, press I/⏻ while pressing INPUT MODE. Each time you press I/⏻, the command mode switches between “C.MODE.AV2” and “C.MODE.AV1”. (The initial setting is “C.MODE.AV2”.) To switch the command mode of the remote, see “Selecting the command mode of the remote” on page 53.
 - Make sure you select the correct input on the remote.
 - You need to assign a component to the AUX and MULTI CH buttons before you can use the buttons to control your audio/video equipment. For details, refer “Programming the remote” on page 53.
 - To activate the buttons with orange printing, press ALT first before pressing the buttons.
 - Before you use the /// buttons for receiver operation, press MAIN MENU. To operate other components, press TOP MENU/GUIDE or AV MENU after pressing the function button.
-

Error messages

If there is a malfunction, the display shows a message. You can check the condition of the receiver by the message. Refer to the following table to solve the problem.

DEC. ERR.

Appears when the signal which the receiver cannot decode (ex. DTS-CD) is input when “DEC. XXXX” in the CUSTOMIZE menu is set to “DEC. PCM”. Set to “DEC. AUTO”.

PROTECT

Irregular current is output from the speakers. The receiver will automatically turn off after a few seconds. Check the speaker connection and turn on the power again. If this problem persists, consult your nearest Sony dealer.

If you are unable to remedy the problem using the troubleshooting guide

Clearing the receiver’s memory may remedy the problem (page 16). However, note that all memorized settings will be reset to their factory settings and you will have to readjust all settings on the receiver.

If the problem persist

Consult your nearest Sony dealer.

Reference sections for clearing the receiver’s memory

To clear	See
All memorized settings	page 16
Customized sound fields	page 39

Specifications

Amplifier section

Power Output

Models of area code CEL, CEK, TW

Rated Power Output at Stereo Mode

(8 ohms 20 Hz – 20 kHz, THD 0.09%)

100 W + 100 W¹⁾

(8 ohms 1 kHz, THD 0.7%)

110 W + 110 W¹⁾

(8 ohms 1 kHz, THD 10%)

135 W + 135 W¹⁾

Reference Power Output¹⁾

(8 ohms 20 Hz – 20 kHz, THD 0.09%)

FRONT²⁾: 100 W/ch

CENTER²⁾: 100 W

SURR²⁾: 100 W/ch

SURR BACK²⁾: 100 W/ch

(8 ohms 1 kHz, THD 0.7%)

FRONT²⁾: 110 W/ch

CENTER²⁾: 110 W

SURR²⁾: 110 W/ch

SURR BACK²⁾: 110 W/ch

(8 ohms 1 kHz, THD 10%)

FRONT²⁾: 135 W/ch

CENTER²⁾: 135 W

SURR²⁾: 135 W/ch

SURR BACK²⁾: 135 W/ch

1) Measured under the following conditions:

Area code	Power requirements
CEL, CEK	230 V AC, 50 Hz
TW	110 V AC, 60 Hz

2) Depending on the sound field settings and the source, there may be no sound output.

Frequency response

PHONO	RIAA equalization curve ±0.5 dB
MULTI CH IN, SA-CD/ CD, MD/TAPE, DVD, TV/SAT, VIDEO 1, 2, 3	10 Hz – 100 kHz +0.5/-2 dB (when ANALOG DIRECT is selected)

Inputs (Analog)

PHONO	Sensitivity: 2.5 mV Impedance: 50 k ohms S/N ³⁾ : 86 dB (A, 2.5 mV ⁴⁾)
MULTI CH IN, SA-CD/ CD, MD/TAPE, DVD, TV/SAT, VIDEO 1, 2, 3	Sensitivity: 150 mV Impedance: 50 k ohms S/N ³⁾ : 96 dB (A, 150 mV ⁴⁾)

3) INPUT SHORT.

4) Weighted network, input level.

Inputs (Digital)

DVD, SA-CD/CD (Coaxial)	Sensitivity: – Impedance: 75 ohms S/N: 100 dB (A, 20 kHz LPF)
DVD, TV/SAT, MD/TAPE, VIDEO 3 (Optical)	Sensitivity: – Impedance: – S/N: 100 dB (A, 20 kHz LPF)

Outputs (Analog)

MD/TAPE (OUT), VIDEO 1, 2 (AUDIO OUT)	Voltage: 150 mV Impedance: 2.2 k ohms
SUB WOOFER	Voltage: 2 V Impedance: 1 k ohm

Outputs (Digital)

MD/TAPE (Optical)	Sensitivity: –
-------------------	----------------

Equalizer

Gain levels	±10 dB, 1 dB step
-------------	-------------------

FM tuner section

Tuning range	87.5 - 108.0 MHz
Antenna	FM wire antenna
Antenna terminals	75 ohms, unbalanced
Intermediate frequency	10.7 MHz
Sensitivity	
Mono:	18.3 dBf, 2.2 μ V/75 ohms
Stereo:	38.3 dBf, 22.5 μ V/75 ohms
Useable sensitivity	11.2 dBf, 1 μ V/75 ohms
S/N	
Mono:	76 dB
Stereo:	70 dB
Harmonic distortion at 1 kHz	
Mono:	0.3%
Stereo:	0.5%
Separation	45 dB at 1 kHz
Frequency response	30 Hz – 15 kHz, +0.5/-2 dB
Selectivity	60 dB at 400 kHz

AM tuner section

Tuning range	
Models of area code	CEL, CEK, TW
With 9-kHz tuning scale:	531 – 1,602 kHz
Antenna	Loop antenna
Intermediate frequency	450 kHz
Usable sensitivity	50 dB/m (at 1,000 kHz or 999 kHz)
S/N	54 dB (at 50 mV/m)
Harmonic distortion	0.5% (50 mV/m, 400 Hz)
Selectivity	
At 9 kHz:	35 dB

Video section

Inputs/Outputs	
Video:	1 Vp-p, 75 ohms
S-video:	Y: 1 Vp-p, 75 ohms C: 0.286 Vp-p, 75 ohms
COMPONENT VIDEO:	Y: 1 Vp-p, 75 ohms Pb/Cb/B-Y: 0.7 Vp-p, 75 ohms Pr/Cr/R-Y: 0.7 Vp-p, 75 ohms 80 MHz HD Pass Through

General

Power requirements

Area code	Power requirements
CEL, CEK	230 V AC, 50/60 Hz
TW	110 V AC, 50/60 Hz

Power consumption

Area code	Power consumption
CEL, CEK	290 W
TW	520 W

Power consumption (during standby mode)
0.3 W

Dimensions (w/h/d) (Approx.)
397 × 160.5 × 430 mm
including projecting parts
and controls

Mass (Approx.) 13.5 kg

Supplied accessories

- FM wire antenna (1)
- AM loop antenna (1)
- Remote commander RM-AAP002 (1)
- R6 (size-AA) batteries (2)
- AC power cord (Except for models of area code TW (Taiwan)) (1)

For details on the area code of the component you are using, see page 2.

Design and specifications are subject to change without notice.

List of button locations and reference pages

How to use this page

Use this page to find the location of buttons and other parts of the receiver that are mentioned in the text.

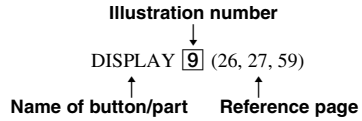

Receiver

ALPHABETICAL ORDER

A - L

- A.F.D. **17** (32, 34)
- Cover **22** (63)
- DIRECT **12** (30)
- DISPLAY **9** (26, 27, 59)
- Display **7** (28)
- INPUT MODE **10** (37)
- INPUT SELECTOR **14** (22, 23, 25, 30, 37, 41, 44, 59)
- IR (receptor) **1** (48, 60)

M - Z

- MAIN MENU **4** (17, 38, 39, 44)
- MASTER VOLUME $-/+$ **11** (16, 20, 22, 58)
- MEMORY/ENTER **5** (16, 17, 25, 44)
- MENU **3** (17, 38, 39, 44)
- MOVIE **16** (33, 34, 59)
- MULTI CHANNEL DECODING (indicator) **8** (23)
- MULTI CH IN **13** (23)
- MUSIC **15** (34, 59)
- PHONES (jack) **25** (22, 58)
- PRESET TUNING $-/+$ **21** (25)

- PUSH **24** (63)
- SPEAKERS (OFF/A/B/A+B) **26** (15, 46, 58)
- SURR BACK DECODING **19** (35)
- TUNING $-/+$ **20** (23)
- VIDEO 3 INPUT (jacks) **23** (6, 7)

NUMBERS AND SYMBOLS

- 2CH **18** (30, 34, 39)
- $-/+$ **6** (17, 38, 40, 44)
- I/⏻ (power) **2** (16, 17, 24, 39, 60)

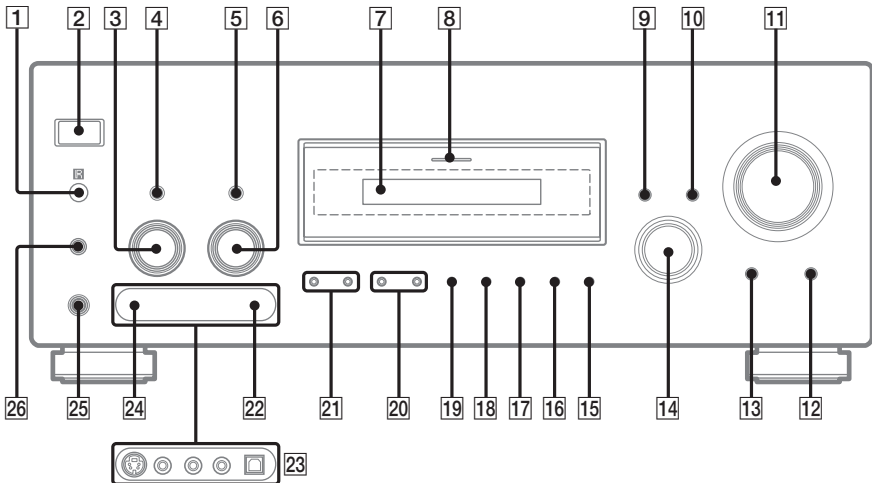

To remove the cover



Press PUSH to remove the cover. When you remove the cover, keep the cover out of reach of the children.

Index

A

- Adjusting
 - CUSTOMIZE parameters 40
 - EQUALIZER parameters 39
 - LEVEL parameters 38, 43
 - speaker levels and balance 20
 - SPEAKER SETUP parameters 17, 41
- Automatic tuning 23

C

- Changing
 - display 27
- Clearing receiver's memory 16
- CUSTOMIZE menu 40

D

- Digital Cinema Sound 33
- Direct tuning 24
- Dual Mono 41
- Dubbing. *See* Recording

E

- Editing. *See* Recording
- EQUALIZER menu 39

I

- Indexing. *See* Naming

L

- Labeling. *See* Naming
- LEVEL menu 38, 43

N

- Naming 44

P

- Preset stations
 - how to 25
 - how to tune 25

R

- RDS 26
- Recording
 - on a video tape 47
 - on an audio tape or MD 46
- Remote commander 48–56

S

- Selecting
 - component 22
 - sound field 33–34
 - speaker system 46
- Sleep Timer 45
- Sound field
 - customizing 38
 - pre-programmed 33–34
 - resetting 39
 - selecting 33–34
- Speaker crossover frequency 42
- SPEAKER SETUP menu 17, 41
- Speakers
 - adjusting speaker levels and balance 20
 - connection 14
 - impedance 14
 - placement 14
- Supplied accessories 62

T

- Test tone 20
- Tuning
 - automatically 23
 - directly 24
 - to preset stations 25