

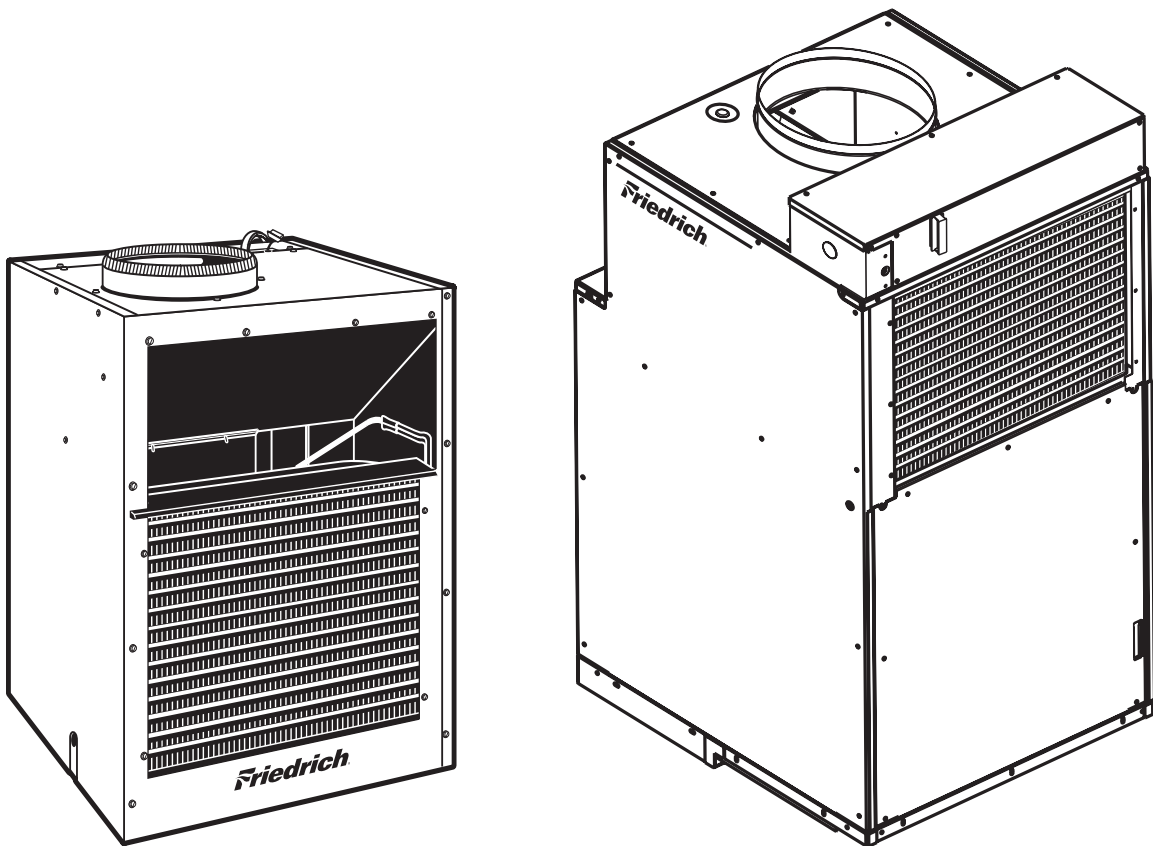

FRIEDRICH

Service Manual – R410A Models



VERT-I-PAK[®] A Series (Electronic Controls) Single Package Vertical Air Conditioning System

L Suffix Models

V(E, H)A09K25L-*	V(E, H)A09K34L-*	V(E, H)A09K50L-*
V(E, H)A12K25L-*	V(E, H)A12K34L-*	V(E, H)A12K50L-*
V(E, H)A18K25L-*	V(E, H)A18K34L-*	V(E, H)A18K25L-*
V(E, H)A24K25L-*	V(E, H)A24K34L-*	V(E, H)A24K50L-*
V(E, H)A24K75L-*	V(E, H)A24K10L-*	

INTRODUCTION

This service manual is designed to be used in conjunction with the installation manuals provided with each unit.

This service manual was written to assist the professional HVAC service technician to quickly and accurately diagnose and repair any malfunctions of this product.

This manual, therefore, will deal with all subjects in a general nature. (i.e. All text will pertain to all models).

IMPORTANT: It will be necessary for you to accurately identify the unit you are servicing, so you can be certain of a proper diagnosis and repair. (See Unit Identification.)

TECHNICAL SUPPORT CONTACT INFORMATION



F R I E D R I C H

FRIEDRICH AIR CONDITIONING CO.

Post Office Box 1540 · San Antonio, Texas 78295-1540
4200 N. Pan Am Expressway · San Antonio, Texas 78218-5212
(210) 357-4400 · 1-800-541-6645 · FAX (210) 357-4490
www.friedrich.com

Printed in the U.S.A.

Table of Contents

Important Safety Information	2-4	Capillary Tube Systems/Check Valve	24
Introduction	4	Reversing Valve — Description/Operation	25
Vert-I-Pak Model Number Identification Guide	5	Testing Coil	25
Serial Number Identification Guide	5	Checking Reversing Valves	25-26
Chassis Specifications	6	Reversing Valve	
Extended Cooling Performance	7	Touch Testing Heating/Cooling Cycle	26
Electrical Requirements	8	Procedure For Changing Reversing Valve	26-27
Remote Thermostat and Low Voltage Control	9-10	Compressor Checks	27
V-PAK Electronic Control Board Features	11	Locked Rotor Voltage Test	27
Electronic Control Configuration	12	Single Phase Connections	27
Electronic Control Error Code		Determine Locked Rotor Voltage	27
Diagnostics/Test Mode	12-13	Locked Rotor Amperage Test	27
Electronic Control Features	14	Single Phase Running & Locked Rotor Amperage	27
Checking External Static Pressure	15	Checking the Overload	27-28
Checking Approximate Airflow	16	External Overload	28
Airflow Charts	16	Compressor Single Phase Resistance Test	28
Components Testing	17-18	Compressor Replacement	29-30
Refrigeration Sequence of Operation	19	Routine Maintenance	30
Service	20	9-18 Electrical Troubleshooting Chart – Cooling	31
Sealed Refrigeration System Repairs	21	2-Ton Electrical Troubleshooting Chart – Cooling	32
Refrigerant Charging	21	Electrical Troubleshooting Chart – Heat Pump	33
Method Of Charging	22	Refrigerant System Diagnosis – Cooling	34
Undercharged Refrigerant Systems	22-23	Refrigerant System Diagnosis – Heating	34
Overcharged Refrigerant Systems	23	Electrical and Thermostat Wiring Diagrams	35-40
Restricted Refrigerant Systems	23	Technical Service Data	41

IMPORTANT SAFETY INFORMATION

The information contained in this manual is intended for use by a qualified service technician who is familiar with the safety procedures required for installation and repair, and who is equipped with the proper tools and test instruments required to service this product.

Installation or repairs made by unqualified persons can result in subjecting the unqualified person making such repairs as well as the persons being served by the equipment to hazards resulting in injury or electrical shock which can be serious or even fatal.

Safety warnings have been placed throughout this manual to alert you to potential hazards that may be encountered. If you install or perform service on equipment, it is your responsibility to read and obey these warnings to guard against any bodily injury or property damage which may result to you or others.

Your safety and the safety of others are very important.

We have provided many important safety messages in this manual and on your appliance. Always read and obey all safety messages.



This is a safety Alert symbol.

This symbol alerts you to potential hazards that can kill or hurt you and others.

All safety messages will follow the safety alert symbol with the word "WARNING" or "CAUTION". These words mean:



You can be killed or seriously injured if you do not follow instructions.



You can receive minor or moderate injury if you do not follow instructions.

All safety messages will tell you what the potential hazard is, tell you how to reduce the chance of injury, and tell you what will happen if the instructions are not followed.



A message to alert you of potential property damage will have the word "NOTICE". Potential property damage can occur if instructions are not followed.

PERSONAL INJURY OR DEATH HAZARDS

ELECTRICAL HAZARDS:

- Unplug and/or disconnect all electrical power to the unit before performing inspections, maintenance, or service.
- Make sure to follow proper lockout/tag out procedures.
- Always work in the company of a qualified assistant if possible.
- Capacitors, even when disconnected from the electrical power source, retain an electrical charge potential capable of causing electric shock or electrocution.
- Handle, discharge, and test capacitors according to safe, established, standards, and approved procedures.
- Extreme care, proper judgment, and safety procedures must be exercised if it becomes necessary to test or troubleshoot equipment with the power on to the unit.

- Do not spray or pour water on the return air grille, discharge air grille, evaporator coil, control panel, and sleeve on the room side of the air conditioning unit while cleaning.
- Electrical component malfunction caused by water could result in electric shock or other electrically unsafe conditions when the power is restored and the unit is turned on, even after the exterior is dry.
- Never operate the A/C unit with wet hands.
- Use air conditioner on a single dedicated circuit within the specified amperage rating.
- Use on a properly grounded outlet only.
- Do not remove ground prong of plug.
- Do not cut or modify the power supply cord.
- Do not use extension cords with the unit.
- Follow all safety precautions and use proper and adequate protective safety aids such as: gloves, goggles, clothing, adequately insulated tools, and testing equipment etc.
- Failure to follow proper safety procedures and/or these warnings can result in serious injury or death.

REFRIGERATION SYSTEM HAZARDS:

- Use approved standard refrigerant recovering procedures and equipment to relieve pressure before opening system for repair.
- Do not allow liquid refrigerant to contact skin. Direct contact with liquid refrigerant can result in minor to moderate injury.
- Be extremely careful when using an oxy-acetylene torch. Direct contact with the torch's flame or hot surfaces can cause serious burns.
- Make sure to protect personal and surrounding property with fire proof materials.
- Have a fire extinguisher at hand while using a torch.
- Provide adequate ventilation to vent off toxic fumes, and work with a qualified assistant whenever possible.
- Always use a pressure regulator when using dry nitrogen to test the sealed refrigeration system for leaks, flushing etc.
- Make sure to follow all safety precautions and to use proper protective safety aids such as: gloves, safety glasses, clothing etc.
- Failure to follow proper safety procedures and/or these warnings can result in serious injury or death.

MECHANICAL HAZARDS:

- Extreme care, proper judgment and all safety procedures must be followed when testing, troubleshooting, handling, or working around unit with moving and/or rotating parts.
- Be careful when, handling and working around exposed edges and corners of sleeve, chassis, and other unit components especially the sharp fins of the indoor and outdoor coils.
- Use proper and adequate protective aids such as: gloves, clothing, safety glasses etc.
- Failure to follow proper safety procedures and/or these warnings can result in serious injury or death.

PROPERTY DAMAGE HAZARDS

FIRE DAMAGE HAZARDS:

- Read the Installation/Operation Manual for this air conditioning unit prior to operating.
- Use air conditioner on a single dedicated circuit within the specified amperage rating.
- Connect to a properly grounded outlet only.
- Do not remove ground prong of plug.
- Do not cut or modify the power supply cord.
- Do not use extension cords with the unit.
- Failure to follow these instructions can result in fire and minor to serious property damage.

WATER DAMAGE HAZARDS:

- Improper installation maintenance, or servicing of the air conditioner unit, or not following the above Safety Warnings can result in water damage to personal items or property.
- Insure that the unit has a sufficient pitch to the outside to allow water to drain from the unit.
- Do not drill holes in the bottom of the drain pan or the underside of the unit.
- Failure to follow these instructions can result in result in damage to the unit and/or minor to serious property damage.

Model Identification Guide

MODEL NUMBER	V	E	A	24	K	50	RT	L
SERIES V=Vertical Series							ENGINEERING CODE	
E=Cooling with or without electric heat H=Heat Pump						OPTIONS RT = Standard Remote Operation J		
DESIGN SERIES A = 32" and 47" Cabinet						ELECTRIC HEATER SIZE A-Series 00 = No electric heat 25 = 2.5 KW 34 = 3.4 KW 50 = 5.0 KW 75 = 7.5 KW 10 = 10 KW		
NOMINAL CAPACITY A-Series (Btu/h) 09 = 9,000 12 = 12,000 18 = 18,000 24 = 24,000								
VOLTAGE K = 208/230V-1Ph-60Hz								

VPAK Serial Number Identification Guide

SERIAL NUMBER	A	K	A	N	00001
YEAR MANUFACTURED LJ = 2009 AE = 2015 AK = 2010 AF = 2016 AA = 2011 AG = 2017 AB = 2012 AH = 2018 AC = 2013 AJ = 2019 AD = 2014				PRODUCTION RUN NUMBER	
			PRODUCT LINE N = VPAK		
MONTH MANUFACTURED					
A = Jan		D = Apr		G = Jul	
B = Feb		E = May		H = Aug	
C = Mar		F = Jun		J = Sep	
				K = Oct	
				L = Nov	
				M = Dec	

Chassis Specifications

Model 2010	VEA09K	VEA12K	VEA18K	VEA24K	VHA09K	VHA12K	VHA18K	VHA24K
COOLING DATA								
COOLING BTUh	9400/9000	11500/11200	17000/16500	23000/22700	9200/9000	11500/11200	17000/16800	23000/22800
POWER (W)	959	1173	1888	2421	939	1186	1868	2527
EER	9.8/9.8	9.8/9.8	9.0/9.0	9.5/9.5	9.8/9.8	9.7/9.7	9.1/9.1	9.1/9.1
SENSIBLE HEAT RATIO	0.74	0.72	0.70	0.70	0.74	0.72	0.70	0.70
HEAT PUMP DATA								
HEATING BTUh	N/A				8500	10800	16000	20000
COP @ 47F	N/A				3.0	3.0	3.0	3.0
HEATING POWER (W)	N/A				830	1055	1563	1953
HEATING CURRENT (A)	N/A				3.6	4.9	7.5	9.4
ELECTRICAL DATA								
VOLTAGE (1 PHASE, 60 Hz)	230/208	230/208	230/208	230/208	230/208	230/208	230/208	230/208
VOLT RANGE	253-198	253-198	253-198	253-198	253-198	253-198	253-198	253-198
COOLING CURRENT (A)	4.2/4.4	5.2/5.4	8.1/8.5	10.0/10.4	4.1/4.3	5.3/5.5	8.2/8.5	10.6/10.8
AMPS L.R.	19.8	30	42	34.8	18.5	26	42	34.8
AMPS F.L.	3.5	4.5	7.8	9.5	3.5	5	7.8	9.5
INDOOR MOTOR (HP)	1/4	1/4	1/4	1/4	1/4	1/4	1/4	1/4
INDOOR MOTOR (A)	1.2	1.2	1.2	1.94	1.2	1.2	1.2	1.94
OUTDOOR MOTOR (HP)	N/A				N/A			
OUTDOOR MOTOR (A)	N/A				N/A			
AIRFLOW DATA								
INDOOR CFM*	300	350	450	610	300	420	450	610
VENT CFM	60	60	60	60	60	60	60	60
MAX. ESP	.3"	.3"	.3"	.4"	.3"	.3"	.3"	.4"
PHYSICAL								
DIMENSIONS (W x D x H)	23x23x32	23x23x32	23x23x32	23x23x47	23x23x32	23x23x32	23x23x32	23x23x47
NET WEIGHT (LBS)	114	124	144	167	114	125	144	167
SHIPPING WEIGHT (LBS)	125	135	155	220	125	135	155	220
R410A CHARGE (oz)	33.5	35.5	48	65	39	42	52	74

* Normal Value Wet Coil @ .1"ESP.

ELECTRIC HEAT DATA						
	VE/VHA09			VE/VHA12		
HEATER WATTS	2500/2050	3400/2780	5000/4090	2500/2050	3400/2780	5000/4090
VOLTAGE	230/208			230/208		
HEATING BTUh	8500/7000	11600/9500	17000/13900	8500/7000	11600/9500	17000/13900
HEATING CURRENT (AMPS)	10.9/9.9	14.8/13.4	21.7/19.7	10.9/9.9	14.8/13.4	21.7/19.7
MINIMUM CIRCUIT AMPACITY	15	19.9	28.6	15	19.9	28.6
BRANCH CIRCUIT FUSE (AMPS)	15	20	30	15	20	30
BASIC HEATER SIZE	2.5 Kw	3.4 Kw	5.0 Kw	2.5 Kw	3.4 Kw	5.0 Kw

ELECTRIC HEAT DATA								
	VE/VHA18			VE/VHA24				
HEATER WATTS	2500/2050	3400/2780	5000/4090	2500/2050	3400/2780	5000/4090	7500/6135	10000/8180
VOLTAGE	230/208			230/208				
HEATING BTUh	8500/7000	11600/9500	17000/13900	8500/7000	11600/9500	17000/13900	25598/20939	34130/27918
HEATING CURRENT (AMPS)	10.9/9.9	14.8/13.4	21.7/19.7	10.9/9.9	14.8/13.4	21.7/19.7	32.6/29.5	43.5/39.3
MINIMUM CIRCUIT AMPACITY	15	19.9	28.6	17.2/15.9	22.1/20.3	30.7/28.1	44.3/40.3	57.9/52.7
BRANCH CIRCUIT FUSE (AMPS)	15	20	30	25	25	30	45	60
BASIC HEATER SIZE	2.5 Kw	3.4 Kw	5.0 Kw	2.5 Kw	3.4 Kw	5.0 Kw	7.5 Kw	10.0 Kw

Extended Cooling Performance

VEA - EXTENDED COOLING PERFORMANCE																
		OUTDOOR DRY BULB TEMP. (DEGREES F AT 40% R.H.)														
		75			85			95			105			110		
		INDOOR WET BULB TEMP. (DEGREES F AT 80 F D.B.)														
		72	67	62	72	67	62	72	67	62	72	67	62	72	67	62
VEA09	BTUh	11054	10631	9842	10528	9926	9156	10114	9400	8319	9475	8413	7417	8954	7835	6914
	WATTS	783	795	804	853	861	872	959	959	959	1037	1036	1039	1084	1083	1087
	AMPS	3.5	3.5	3.5	3.7	3.8	3.8	4.2	4.20	4.2	4.5	4.5	4.5	4.7	4.7	4.7
	SHR	0.51	0.69	0.93	0.52	0.71	0.95	0.52	0.74	0.95	0.53	0.78	0.96	0.55	0.81	0.95
VEA12	BTUh	13524	13007	12041	12880	12144	11201	12374	11500	10178	11592	10293	9074	10954	9585	8458
	WATTS	957	972	983	1043	1053	1066	1173	1173	1173	1268	1267	1270	1325	1325	1330
	AMPS	4.3	4.3	4.4	4.6	4.7	4.7	5.2	5.20	5.2	5.6	5.6	5.6	5.9	5.9	5.9
	SHR	0.49	0.67	0.90	0.50	0.70	0.92	0.51	0.72	0.92	0.52	0.76	0.93	0.53	0.79	0.93
VEA18	BTUh	19992	19227	17799	19040	17952	16558	18292	17000	15045	17136	15215	13413	16193	14170	12504
	WATTS	1541	1565	1582	1678	1695	1716	1888	1888	1888	2041	2039	2045	2133	2132	2140
	AMPS	6.7	6.7	6.8	7.2	7.2	7.3	8.1	8.10	8.1	8.7	8.7	8.7	9.1	9.1	9.1
	SHR	0.48	0.65	0.88	0.49	0.68	0.89	0.49	0.70	0.90	0.50	0.74	0.90	0.52	0.76	0.9
VEA24	BTUh	27048	26013	24081	25760	24288	22402	24748	23000	20355	23184	20585	18147	21908	19171	16917
	WATTS	1976	2007	2029	2152	2174	2201	2421	2421	2421	2617	2615	2622	2736	2735	2744
	AMPS	8.3	8.3	8.4	8.9	9.0	9.0	10.0	10.00	10.1	10.8	10.8	10.8	11.3	11.3	11.3
	SHR	0.48	0.65	0.88	0.49	0.68	0.89	0.49	0.70	0.9	0.5	0.74	0.9	0.52	0.76	0.9
		RATING POINT ARI 310/380														

VHA - EXTENDED COOLING PERFORMANCE																
		OUTDOOR DRY BULB TEMP. (DEGREES F AT 40% R.H.)														
		75			85			95			105			110		
		INDOOR WET BULB TEMP. (DEGREES F AT 80 F D.B.)														
		72	67	62	72	67	62	72	67	62	72	67	62	72	67	62
VHA09	BTUh	10819	10405	9632	10304	9715	8961	9899	9200	8142	9274	8234	7259	8763	7668	6767
	WATTS	766	778	787	835	843	854	939	939	939	1015	1014	1017	1061	1061	1064
	AMPS	3.4	3.4	3.5	3.7	3.7	3.7	4.1	4.10	4.1	4.4	4.4	4.4	4.6	4.6	4.6
	SHR	0.51	0.69	0.93	0.52	0.71	0.95	0.52	0.74	0.95	0.53	0.78	0.96	0.55	0.81	0.95
VHA12	BTUh	13524	13007	12041	12880	12144	11201	12374	11500	10178	11592	10293	9074	10954	9585	8458
	WATTS	968	983	994	1054	1065	1078	1186	1186	1186	1282	1281	1284	1340	1340	1344
	AMPS	4.4	4.4	4.5	4.7	4.7	4.8	5.3	5.30	5.3	5.7	5.7	5.7	6	6	6
	SHR	0.49	0.67	0.9	0.5	0.7	0.92	0.51	0.72	0.92	0.52	0.76	0.93	0.53	0.79	0.93
VHA18	BTUh	19992	19227	17799	19040	17952	16558	18292	17000	15045	17136	15215	13413	16193	14170	12504
	WATTS	1524	1549	1565	1661	1677	1698	1868	1868	1868	2019	2017	2023	2111	2110	2117
	AMPS	6.8	6.8	6.9	7.3	7.3	7.4	8.2	8.20	8.2	8.8	8.8	8.9	9.2	9.2	9.3
	SHR	0.48	0.65	0.88	0.49	0.68	0.89	0.49	0.70	0.90	0.50	0.74	0.90	0.52	0.76	0.9
VHA24	BTUh	27048	26013	24081	25760	24288	22402	24748	23000	20355	23184	20585	18147	21908	19171	16917
	WATTS	2062	2095	2118	2247	2269	2297	2527	2527	2527	2732	2729	2737	2856	2854	2864
	AMPS	8.8	8.8	8.9	9.4	9.5	9.5	10.5	10.60	10.7	11.4	11.4	11.4	11.9	11.9	12
	SHR	0.48	0.65	0.88	0.49	0.68	0.89	0.49	0.70	0.90	0.50	0.74	0.90	0.52	0.76	0.9
		RATING POINT ARI 310/380														

⚠ WARNING



ELECTRIC SHOCK HAZARD

Turn off electric power before service or installation. All electrical connections and wiring **MUST** be installed by a qualified electrician and conform to the National Electrical Code and all local codes which have jurisdiction. Failure to do so can result in personal injury and/or death.

ELECTRICAL REQUIREMENTS

Wire Size	Use ONLY wiring size recommended for single outlet branch circuit.
Fuse/Circuit Breaker	"Use ONLY time delayed fused disconnect or HACR type circuit breaker as indicated on the unit's rating plate (see sample on this page). Proper current protection to the unit is the responsibility of the owner".
Grounding	Unit MUST be grounded from branch circuit to unit, or through separate ground wire provided on permanently connected units. Be sure that branch circuit outlet is grounded.
Wire Sizing	Use recommended wire size given in tables and install a single branch circuit. All wiring must comply with local and national codes. NOTE: Use copper conductors only.

Note: All field wiring must comply with NEC and local codes. It is the responsibility of the installer to insure that the electrical codes are met.

All units must be hard wired with properly sized breaker. See nameplate for specific chassis electrical requirements. See Electrical Rating Table below for wire size. Use HACR type breakers to avoid nuisance trips. All field wiring must be done in accordance with NEC and local codes.

Electrical Rating Tables

NOTE: Use copper conductors **ONLY**. Wire sizes are per NEC. Check local codes for overseas applications

Recommended branch circuit wire sizes*	
Nameplate maximum circuit breaker size	AWG Wire size**
15A	14
20A	12
30A	10

AWG — American Wire Gauge * Single circuit from main box. ** Based on copper wire, single insulated conductor at 60°C

Supply voltage

Supply voltage to the unit should be a nominal 208/230 volts. It must be between 197 volts and 253 volts. Supply voltage to the unit should be checked **WITH THE UNIT IN OPERATION**. Voltage readings outside the specified range can be expected to cause operating problems. Their cause **MUST** be investigated and corrected.

Sample Nameplate

MODEL NO 1
SERIAL NO *
FRIEDRICH AIR CONDITIONING CO.
SAN ANTONIO, TEXAS

VOLTS: 24,33,34
VOLTAGE RANGE: 255-197
REFRIG CHARGE: 7 OZS. R22
DESIGN PRESSURE: 575 PSIG HS / 150 PSIG LS
COOLING: BTU/HR 8
SEER: 10 COP: 16
HEAT PUMP BTU/HR: 14
TOTAL COOLING AMPS: 9
TOTAL ELEC. HEAT AMPS: 15
ELECTRIC HEAT WATTS: 18

FOR PERMANENTLY CONNECTED UNITS ONLY:
COMP: PLA 11 LRA 12
MOTOR: FLA 13 HP 19
HEATER AMPS: 17
MIN. CKT AMP -0 USE -1 MAX. TIME DELAY FUS
OR HACR TYPE CIRCUIT BREAKER.

GENERAL UNIT INFORMATION:
MAX OUTLET AIR TEMPERATURE: 200°F
MAX EXTERNAL STATIC PRESSURE ELECTRIC
HEAT...5 IN. WATER
"O" CLEARANCE TO COMBUSTIBLE MATERIAL

USE ON SINGLE OUTLET CIRCUIT ONLY

WARNING

ELECTRICAL SHOCK AND
MOVING PARTS HAZARD
CAN CAUSE INJURY OR
DEATH.

PULL OUT DISCONNECT
HEAT CUT-OFF ON THE
FRONT OF THIS UNIT TO
DISABLE POWER BEFORE
SERVICING.

LISTED
120524
HEATING AND
COOLING EQUIPMENT

APPLICABLE PATENTS: US
6,065,296

NY MEA NO.: 295-00-E
USE ONE OF THE
FOLLOWING ITEMS
FROM EACH CATEGORY
TO COMPLETE THE
ASSEMBLY

WALL PLENUM:
VPAWP1 -8
VPAWP1 -14
OUTDOOR GRILLE
VPAL2
INDOOR GRILLE
VPRG1
VPRG2
VPRG5

REMOTE THERMOSTAT AND LOW VOLTAGE CONTROL CONNECTIONS

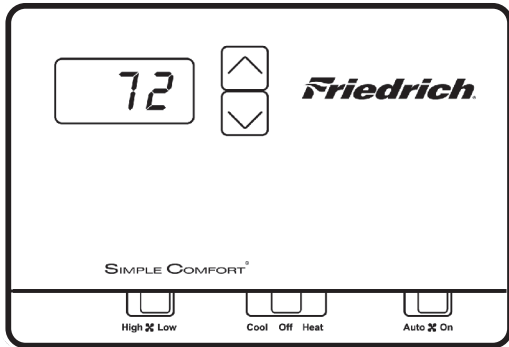

RT5 (Two speed fan)

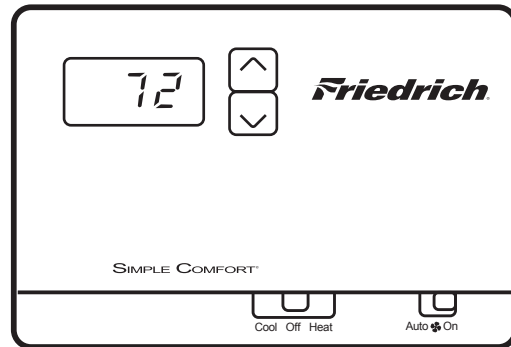

RT4 (One speed fan)

Remote Thermostat

All Friedrich Vert-I-Pak units are factory configured to be controlled by using a 24V single stage remote wall mounted thermostat. The thermostat may be auto or manual changeover as long as the control configuration matches that of the Vert-I-Pak unit.

Manual Changeover Thermostat

For Heat Pump equipped units: a single stage, heat/cool thermostat with a terminal for a reversing valve operation is required. Terminal "B" should be continuously energized in the heat mode and terminal "G" should be energized whenever there is a call for heating or cooling. (Typically, a single stage, heat/cool thermostat designed for use with electric heat systems will meet the above requirements).

NOTICE

DO NOT use a two (2) stage Heat Pump Thermostat. Use of this type of thermostat may result in equipment and/or property damage

To control the unit with a wall-mounted thermostat:

- 1) Pull the disconnect switch.
- 2) Unscrew and remove the control box panel.
- 3) After selecting which side you want to run your thermostat wire through, run the wires through the side hole in the box to reach the connection terminal for the wiring.
- 4) Make the wire connections, appropriately matching the wires as shown in the wiring diagram.
- 5) Once each wire is matched and connected, the unit is now controlled by the thermostat.
- 6) Reattach the control box cover.

Location

The thermostat should not be mounted where it may be affected by drafts, discharge air from registers (hot or cold), or heat radiated from the sun or appliances.

The thermostat should be located about 5 Ft. above the floor in an area of average temperature, with good air circulation. Close proximity to the return air grille is the best choice.

Mercury bulb type thermostats MUST be level to control temperature accurately to the desired set-point. Electronic digital type thermostats SHOULD be level for aesthetics.

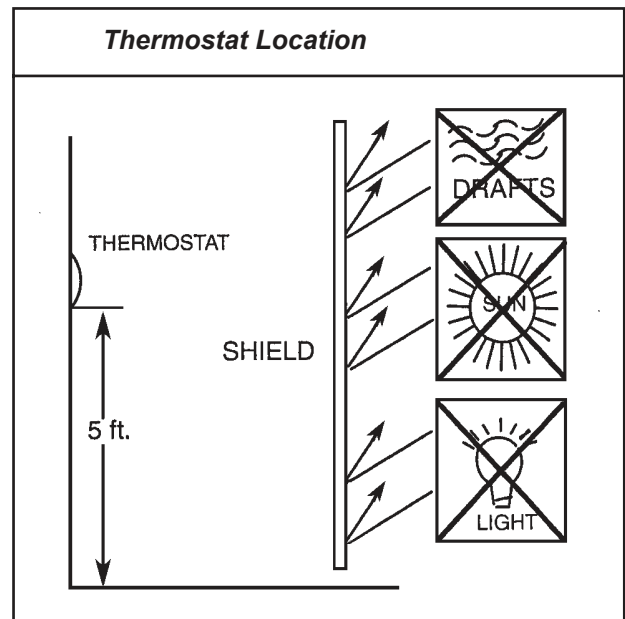

NOTE: An improperly operating, or poorly located room thermostat can be the source of perceived equipment problems. A careful check of the thermostat and wiring must be made then to insure that it is not the source of problems.

REMOTE THERMOSTAT AND LOW VOLTAGE CONTROL CONNECTIONS (Continued)

Thermostat Connections

- C = Common Ground
- W = Call for Heating
- Y = Call for Cooling
- R = 24V Power from Unit
- GL = Call for Fan (Low Speed)
- GH = Call for Fan (High Speed)
- B = Reversing Valve Energized in heating mode

*If only one G terminal is present on thermostat, connect to GL for low fan or to GH for high fan operation.

NOTE: It is the installer's responsibility to ensure that all control wiring connections are made in accordance with the Friedrich installation instructions. Questions concerning proper connections to the unit should be directed to the factory: 210-357-4400.

Desk Control Terminals

The Friedrich VERT-I-PAK has built-in provisions for connection to an external switch to control power to the unit. The switch can be a central desk control system or even a normally open door switch.

For desk control operation, connect one side of the switch to the D1 terminal and the other to the D2 terminal. Whenever the switch closes, the unit operation will stop.

Maximum Wire Length for Desk Control Switch

Wire Size	Maximum Length
#24	400 ft.
#22	600 ft.
#20	900 ft.
#18	1500 ft.
#16	2000 ft.

Note: The desk control system and switches must be field supplied.

Auxiliary Fan Control

The Smart Center also has the ability to control a 24VAC relay to activate an auxiliary, or transfer, fan. The outputs are listed as F1 and F2 on the control board.

To connect the relay, simply wire one side of the relay to F1 and the other side to F2. Anytime that the fan runs, the terminals will send a 24VAC signal to the relay. The relay must be 24 VAC, 50mA or less.

Note: The relay and auxiliary fans must be field supplied.

ELECTRONIC CONTROL BOARD FEATURES

The new Friedrich Vert-I-Pak has state of the art features to improve guest comfort and conserve energy. Through the use of specifically designed control software, Friedrich has accomplished what other Manufacturer's have only attempted – a quiet, dependable, affordable and easy to use Vert-I-Pak.

Below is a list of standard features on every Friedrich VPAK and their benefit to the owner.

Quiet Start/Stop Fan Delay	The fan start and stop delays prevent abrupt changes in room acoustics due to the compressor energizing or stopping immediately. Upon call for cooling or heating the unit fan will run for five seconds prior to energizing the compressor. Also, the fan off delay allows for “free cooling” by utilizing the already cool indoor coil to its maximum capacity by running for 30 seconds after the compressor.
Remote Thermostat Operation	VPAK units are thermostat controlled.
Internal Diagnostic Program	The new Friedrich digital VPAK features a self diagnostic program that can alert maintenance to component failures or operating problems. The internal diagnostic program saves properties valuable time when diagnosing running problems.
Service Error Code Storage	The self diagnosis program will also store error codes in memory if certain conditions occur and correct themselves such as extreme high or low operating conditions or activation of the room freeze protection feature. Storing error codes can help properties determine if the unit faced obscure conditions or if an error occurred and corrected itself.
Room Freeze Protection	When the VPAK senses that the indoor room temperature has fallen to 40°F the unit will cycle on high fan and the electric strip heat to raise the room temperature to 46°F then cycle off again. This feature works regardless of the mode selected and can be turned off. The control will also store the Room Freeze cycle in the service code memory for retrieval at a later date. This feature ensures that unoccupied rooms do not reach freezing levels where damage can occur to plumbing and fixtures.
Random Compressor Restart	Multiple compressors starting at once can often cause electrical overloads and premature unit failure. The random restart delay eliminates multiple units from starting at once following a power outage or initial power up. The compressor delay will range from 180 to 240 seconds.
Digital Defrost Thermostat	The new Friedrich VPAK uses a digital thermostat to accurately monitor the outdoor coil conditions to allow the heat pump to run whenever conditions are correct. Running the VPAK in heat pump mode save energy and reduces operating costs. The digital thermostat allows maximization of heat pump run time.
Instant Heat Heat Pump Mode	Heat pump models will automatically run the electric heater during compressor lock-out to quickly provide heat when initially energized, then return to heat pump mode. This ensures that the room is heated quickly without the usual delay associated with heat pump units.
Emergency Heat Override	In the event of a compressor failure in heat pump mode the compressor may be locked out to provide heat through the resistance heater. This feature ensures that even in the unlikely event of a compressor failure the room temperature can be maintained until the compressor can be serviced.
Desk Control Ready	All electronic VPAK units have low voltage terminals ready to connect a desk control energy management system. Controlling the unit from a remote location like the front desk can reduce energy usage and requires no additional accessories at the VPAK.
Indoor Coil Frost Sensor	The frost sensor protects the compressor from damage in the event that airflow is reduced or low outdoor temperatures cause the indoor coil to freeze. When the indoor coil reaches 30°F the compressor is disabled and the fan continues to operate based on demand. Once the coil temperature returns to 45°F the compressor returns to operation.
Ultra-Quiet Air System	The VPAK series units feature a indoor fan system design that reduces sound levels without lowering airflow and preventing proper air circulation.
High Efficiency	The VPAK benefits quality components and extensive development to ensure a quiet, efficient and dependable unit.
Rotary Compressor	High efficiency rotary compressors are used on all Friedrich VPAKs to maximize durability and efficiency.
Auxiliary Fan Ready	The VPAK features a 24V AC terminal for connection to an auxiliary fan that may be used to transfer air to adjoining rooms. Auxiliary fans can provide conditioning to multiple rooms.

Electronic Control Configuration

The adjustable control dip switches are located at the lower left hand portion of the digital Smart Center. The inputs are only visible and accessible with the front cover removed from the Unit.

Factory Dip Switch Configuration

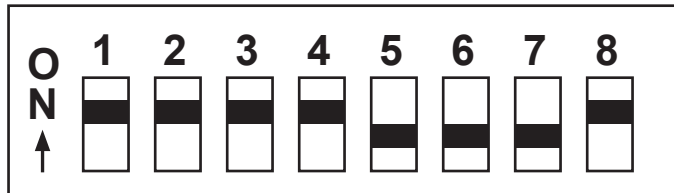

Dip Switch Setting

Switches 1-4 ON

Switch 5-7 OFF

Switch 8 ON

Room Freeze Protection – Switch 6

Units are shipped from the factory with the room freeze protection disabled. Room Freeze Protection can be switched on at the owner's preference by moving Dip Switch 6 to 'ON'. This feature will monitor the indoor room conditions and in the event that the room falls below 40°F the unit will cycle on high fan with the electric heater. This occurs regardless of mode.

Emergency Heat Override – Switch 7

Units are shipped from the factory with the room emergency heat override disabled. In the unlikely event of a compressor failure a heat pump unit may be switched to operate in only the electric heat mode until repairs can be made, by moving Dip Switch 7 to 'ON'.

Discharge Air Sensor Override – Switch 8

This switch MUST remain in the "ON" position for Vert-I-Pak models, since they do not use a discharge air sensor. If the switch is positioned in the "OFF" position on these models it will result in the erroneous display Error Code 14 indicating that the Discharge air temperature sensor is open or shorted.

Note: In order for the control to recognize "Dip" switch setting changes, the unit must be disconnected from power supply when making any configuration changes.

Electronic Control Error Code Diagnostics and Test Mode

Error Code Diagnostics

The VPAK electronic control continuously monitors the Vert-I-Pak unit operation and will store error codes if certain conditions are witnessed. In some cases the unit may take action and shut the unit off until conditions are corrected.

To access the error code menu press the 'HEAT' and 'HIGH FAN' buttons simultaneously for three seconds. If error codes are present they will be displayed. If multiple codes exist you can toggle between error codes using the **temp up ▲** button. To clear all codes press the **temp down ▼** button for three seconds while in the error code mode. To exit without losing codes press the 'Low Fan' button.

Button Location for Vert-I-Pak Models

With the remote thermostat escutcheon installed, the button locations to access the diagnostics mode can be located as shown below.

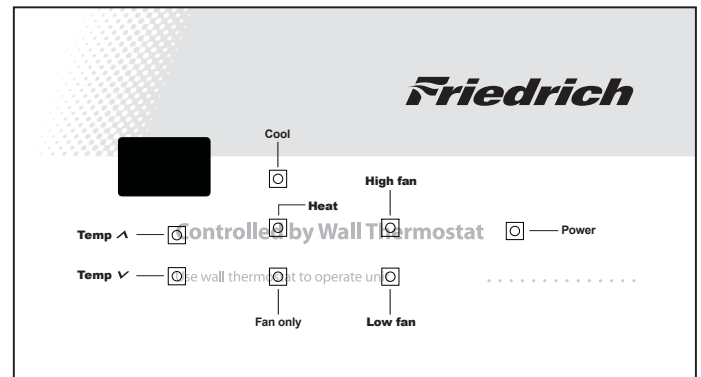

- * Heat and high fan - access error codes
- * Temp up ▲ and temp down ▼ - toggle between error codes
- * Low fan - exit error code mode without losing stored error codes.
- * Temp down ▼ - clears all error codes

NOTE: Hold buttons down for three seconds.

Electronic Control Error Code Diagnostics

Error Code	Code Translation	Action Taken By Unit	Possible Cause
EF	Error Free	None	Unit Operating Normally
02	Extreme low voltage condition exists (<198V for 230V units and <239V for 265V units).	Shut unit down. Flash error code. When voltage rises to adequate level normal unit operation is restored.	<ul style="list-style-type: none"> • Inadequate power supply • Defective breaker • Blown fuse
03	Return air thermistor sensor open or short circuit	Leave unit running. Alternately flash error code and set point.	<ul style="list-style-type: none"> • Defective sensor
04	Indoor coil thermistor sensor open or short circuit	Leave unit running. Alternately flash error code and set point.	
05	Outdoor coil thermistor sensor open or short circuit	Leave unit running. Switch to Electric Heat Mode (Heat Pump only). Alternately flash error code and set point.	<ul style="list-style-type: none"> • Defective sensor
06	Outdoor coil Temperature > 175° F for 2 consecutive minutes. (Heat Pump models only)	Shut unit down for 5 minutes, Alternately flash error code and set point, then try again 2 times, if unit fails the 3rd time then shut unit down and alternately flash error code and set point.	<ul style="list-style-type: none"> • Dirty coil • Fan motor failure • Restricted air flow • Non-condensables in refrigeration system
07	Indoor coil temperature <30° F for 2 consecutive minutes.	Shut down Compressor, and continue fan operation. Alternately flash error code and set point until the indoor coil thermistor reaches 45° F. Then, (after lockout time of 180 to 240 seconds expires), re-energize the compressor .	<ul style="list-style-type: none"> • Dirty filters • Dirty coil • Fan motor failure • Restricted air flow • Improper refrigerant charge • Restriction in refrigerant circuit
08	Unit cycles (Heat or Cool demand) > 9 times per hour	Leave unit running. Store error code in memory.	<ul style="list-style-type: none"> • Unit oversized • Low load conditions
09	Unit cycles (Heat or Cool demand) < 3 times per hour	Leave unit running. Store Error Code in memory.	<ul style="list-style-type: none"> • Unit undersized • High load conditions
10	Room Freeze Protection triggered	Leave unit running. Alternately flash error code and set point.	<ul style="list-style-type: none"> • Room temperature fell below 40°F
11	No Signal to "GL or "GH" terminal	Shut unit down. Flash error code.	<ul style="list-style-type: none"> • Defective remote thermostat • Defective thermostat wiring
13	High Pressure switch open (24K BTU Only) Jumper wire loose/missing (9-18K BTU)	Shut unit down. Flash error code.	<ul style="list-style-type: none"> • Dirty coil • Fan motor failure • Restricted air flow • Non-condensables in refrigeration system
14	Discharge air temperature sensor open or shorted	Leave unit running. Alternately flash error code and set point.	<ul style="list-style-type: none"> • Dip switch # 8 set to "OFF" position

Diagnostics

The Electronic control continuously monitors the VPAK unit operation and will store service codes if certain conditions are witnessed. In some cases the unit may take action and shut the unit off until conditions are corrected. To access the error code menu press the **'Heat'** and **'High Fan'** buttons simultaneously for three seconds. If error codes are present they will be displayed. If multiple codes exist you can toggle between messages using the temp up \blacktriangle button. To clear all codes press the temp down \blacktriangledown button for three seconds while in the error code mode. To exit without changing codes press the **'Low Fan'** button.

Test Mode

For service and diagnostic use only, the built-in timers and delays on the VPAK may be bypassed by pressing the **'Cool'** and **'Low Fan'** buttons simultaneously for three seconds while in any mode to enter the test mode. $\mathcal{L}E$ will be displayed when entering test mode, and $\mathcal{D}E$ will be displayed when exiting. The test mode will automatically be exited 30 minutes after entering it or by pressing the **'Cool'** and **'Low Fan'** buttons simultaneously for three seconds.

Note: To access the Test Mode while under remote wall thermostat operation, remove thermostat's wires at the terminal block on the electronic control board then connect a jumper wire between GL and GH.

VPAK ELECTRONIC CONTROL FEATURES

Thermostat Compatibility:

The VPAK Electronic Control is compatible with Friedrich **RT4** and **RT5** Thermostats.

The VPAK Electronic control is also compatible with most standard Single Stage Heat/Cool Thermostats.

NOTE: Field supplied Thermostats **MUST** energize the fan circuit on a call for Heating or Cooling, and (when used with a Heat Pump Unit) **MUST** energize the “B” terminal in Heating in order for the unit to function correctly.

Compressor Time Delay:

The Electronic control is equipped with a random (180 to 240 seconds) Compressor time delay that is initiated every time the compressor cycles “Off.” The “delay on break” timer is initiated by the following actions:

- (1) Satisfying the temperature set point
- (2) Changing mode to fan only
- (3) Turning the unit off
- (4) Restoring power after a failure

Note: The Compressor Time Delay feature is disabled during “Test Mode” operation.

Fan delay:

The Electronic Control is equipped with a feature that will start the fan 5 seconds **EARLY** (i.e. before compressor or heater) when unit cycles “**ON.**” When the unit cycles “**OFF**” the fan will **DELAY** for 30 seconds in Cooling and 15 seconds in Heating.

Note: the fan delay is disabled during **Test Mode operation.**

Emergency Heat:

The Electronic Control is equipped with a feature that allows servicer/end user to switch to electric heat operation when the compressor fails during the heating season, (See DIP switch position 7) until the compressor can be replaced.

External Static Pressure

External Static Pressure can best be defined as the pressure difference (drop) between the Positive Pressure (discharge) and the Negative Pressure (intake) sides of the blower. External Static Pressure is developed by the blower as a result of resistance to airflow (Friction) in the air distribution system EXTERNAL to the VERT-I-PAK cabinet.

Resistance applied externally to the VERT-I-PAK (i.e. duct work, filters, etc.) on either the supply or return side of the system causes an INCREASE in External Static Pressure accompanied by a REDUCTION in airflow.

External Static Pressure is affected by two (2) factors.

1. Resistance to Airflow as already explained.
2. Blower Speed. Changing to a higher or lower blower speed will raise or lower the External Static Pressure accordingly.

These affects must be understood and taken into consideration when checking External Static Pressure/Airflow to insure that the system is operating within design conditions.

Operating a system with insufficient or excessive airflow can cause a variety of different operating problems. Among these are reduced capacity, freezing evaporator coils, premature compressor and/or heating component failures. etc.

System airflow should always be verified upon completion of a new installation, or before a change-out, compressor replacement, or in the case of heat strip failure to insure that the failure was not caused by improper airflow.

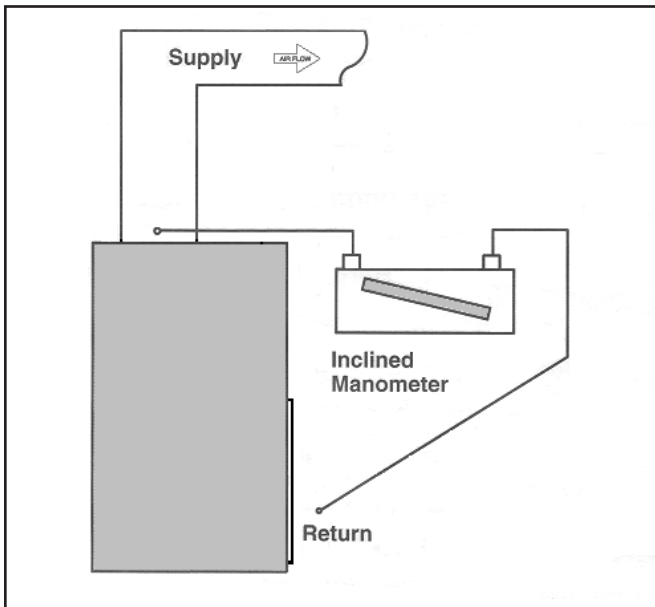

Checking External Static Pressure

The airflow through the unit can be determined by measuring the external static pressure of the system, and consulting the blower performance data for the specific VERT-I-PAK.

1. Set up to measure external static pressure at the supply and return air.
2. Ensure the coil and filter are clean, and that all the registers are open.
3. Determine the external static pressure with the blower operating.
4. Refer to the Air Flow Data for your VERT-I-PAK system to find the actual airflow for factory-selected fan speeds.
5. If the actual airflow is either too high or too low, the blower speed will need to be changed to appropriate setting or the ductwork will need to be reassessed and corrections made as required.
6. Select a speed, which most closely provides the required airflow for the system.
7. Recheck the external static pressure with the new speed. External static pressure (and actual airflow) will have changed to a higher or lower value depending upon speed selected. Recheck the actual airflow (at this "new" static pressure) to confirm speed selection.
8. Repeat steps 8 and 9 (if necessary) until proper airflow has been obtained.

EXAMPLE: Airflow requirements are calculated as follows: (Having a wet coil creates additional resistance to airflow. This additional resistance must be taken into consideration to obtain accurate airflow information.)

Determining the Indoor CFM: Chart A - CFM

ESP (")	Model					
	VEA09/VHA09		VEA12/VHA12		VEA18/VHA18	
	Low	High	Low	High	Low	High
.00"	340	385	420	470	430	480
.10"	300	340	350 *	420 **	400	450
.20"	230	280	290	350	340	400
.30"	140	190	250	300	290	330

Highlighted values indicate rated performance point.

Rated performance for

* VEA12

Rated Performance for

** VHA12

ESP (")	Model	
	VEA24/VHA24	
	Low	High
.00"	690	740
.10"	610	700
.20"	560	640
.30"	510	580
.40"	450	520

Highlighted values indicate rated performance point.

**Correct CFM (if needed):
Chart B – Correction Multipliers**

Correction Multipliers for:	
230V	1.00
208V	0.97
Heating	1.00
Cooling	0.95

Explanation of charts

Chart A is the nominal dry coil VERT-I-PAK CFMs. Chart B is the correction factors beyond nominal conditions.

1 ½ TON SYSTEM (18,000 Btu)

Operating on high speed @ 230 volts with dry coil

measured external static pressure .10

Air Flow = 450 CFM

In the same SYSTEM used in the previous example but having a WET coil you must use a correction factor of .95 (i.e. 450 x .95=428 CFM) to allow for the resistance (internal) of the condensate on the coil.

It is important to use the proper procedure to check external Static Pressure and determine actual airflow. Since in the case of the VERT-I-PAK, the condensate will cause a reduction in measured External Static Pressure for the given airflow.

It is also important to remember that when dealing with VERT-I-PAK units that the measured External Static Pressure increases as the resistance is added externally to the cabinet. Example: duct work, filters, grilles.

Indoor Airflow Data

The Vert-I-Pak A series units must be installed with a free return air configuration. The table below lists the indoor airflow at corresponding static pressures. All units are ratted at low speed.

The Vert-I-Pak units are designed for either single speed or two fan speed operation. For single speed operation refer to the airflow table below and select the most appropriate CFM based on the ESP level. Connect the fan output from the thermostat to the unit on either the GL terminal for low speed or to the GH terminal for high speed operation.

For thermostats with two-speed fan outputs connect the low speed output to the unit GL terminal and the high speed output to the GH terminal.

Ductwork Preparation

If flex duct is used, be sure all the slack is pulled out of the flex duct. Flex duct ESP can increase considerably when not fully extended. DO NOT EXCEED a total of .30 ESP, as this is the MAXIMUM design limit for the VERT-I-PAK A-Series unit.

IMPORTANT: FLEX DUCT CAN COLLAPSE AND CAUSE AIRFLOW RESTRICTIONS. DO NOT USE FLEX DUCT FOR: 90 DEGREE BENDS, OR UNSUPPORTED RUNS OF 5 FT. OR MORE.

Fresh Air Door

The Fresh Air Door is an “intake” system. The fresh air door opened via a slide on the front of the chassis located just above the indoor coil. Move the slide left to open and right to close the fresh air door. The system is capable of up to 60 CFM of fresh air @ ~.3” H2O internal static pressure.

Checking Approximate Airflow

If an inclined manometer or Magnehelic gauge is not available to check the External Static Pressure, or the blower performance data is unavailable for your unit, approximate air flow call be calculated by measuring the temperature rise, then using tile following criteria.

$$\frac{\text{KILOWATTS} \times 3413}{\text{Temp Rise} \times 1.08} = \text{CFM}$$

Electric Heat Strips

The approximate CFM actually being delivered can be calculated by using the following formula:

DO NOT simply use the Kilowatt Rating of the heater (i.e. 2.5, 3.4, 5.0) as this will result in a less-than-correct airflow calculation. Kilowatts may be calculated by multiplying the measured voltage to the unit (heater) times the measured current draw of all heaters (ONLY) in operation to obtain watts. Kilowatts are than obtained by dividing by 1000.

EXAMPLE: Measured voltage to unit (heaters) is 230 volts. Measured Current Draw of strip heaters is 11.0 amps.

$$\begin{aligned} 230 \times 11.0 &= 2530 \\ 2530/1000 &= 2.53 \text{ Kilowatts} \\ 2.53 \times 3413 &= 8635 \end{aligned}$$

Supply Air	95°F
Return Air	<u>- 75°F</u>
Temperature Rise	20°

$$20 \times 1.08 = 21.6$$

$$\frac{8635}{21.6} = 400 \text{ CFM}$$

COMPONENTS TESTING

BLOWER / FAN MOTOR

A single phase permanent split capacitor motor is used to drive the evaporator blower and condenser fan. A self-resetting overload is located inside the motor to protect against high temperature and high amperage conditions.

⚠ WARNING	
	ELECTRIC SHOCK HAZARD Disconnect power to the unit before servicing. Failure to follow this warning could result in serious injury or death.

BLOWER / FAN MOTOR TEST

1. Visually inspect the motor's wiring, housing etc., and determine that the capacitor is serviceable.
2. Make sure the motor has cooled down.
3. Disconnect the fan motor wires from the control board.
4. Test for continuity between the windings also, test to ground.
5. If any winding is open or grounded replace the motor.

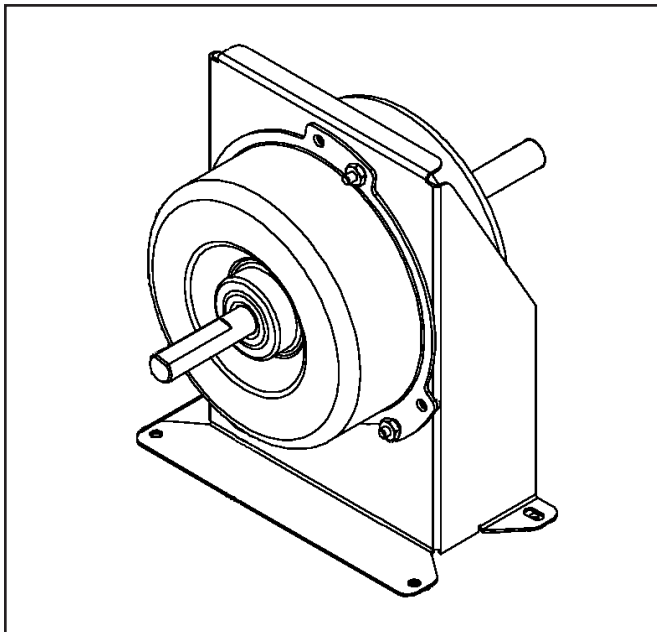

CAPACITORS

⚠ WARNING	
	ELECTRIC SHOCK HAZARD Turn off electric power before servicing. Discharge capacitor with a 20,000 Ohm 2 Watt resistor before handling. Failure to do so may result in personal injury, or death.

Many motor capacitors are internally fused. Shorting the terminals will blow the fuse, ruining the capacitor. A 20,000 ohm 2 watt resistor can be used to discharge capacitors safely. Remove wires from capacitor and place resistor across terminals. When checking a dual capacitor with a capacitor analyzer or ohmmeter, both sides must be tested.

Capacitor Check with Capacitor Analyzer

The capacitor analyzer will show whether the capacitor is "open" or "shorted." It will tell whether the capacitor is within its micro farads rating and it will show whether the capacitor is operating at the proper power-factor percentage. The instrument will automatically discharge the capacitor when the test switch is released.

Capacitor Connections

The starting winding of a motor can be damaged by a shorted and grounded running capacitor. This damage usually can be avoided by proper connection of the running capacitor terminals.

From the supply line on a typical 230 volt circuit, a 115 volt potential exists from the "R" terminal to ground through a possible short in the capacitor. However, from the "S" or start terminal, a much higher potential, possibly as high as 400 volts, exists because of the counter EMF generated in the start winding. Therefore, the possibility of capacitor failure is much greater when the identified terminal is connected to the "S" or start terminal. The identified terminal should always be connected to the supply line, or "R" terminal, never to the "S" terminal.

When connected properly, a shorted or grounded running capacitor will result in a direct short to ground from the "R" terminal and will blow the line fuse. The motor protector will protect the main winding from excessive temperature.

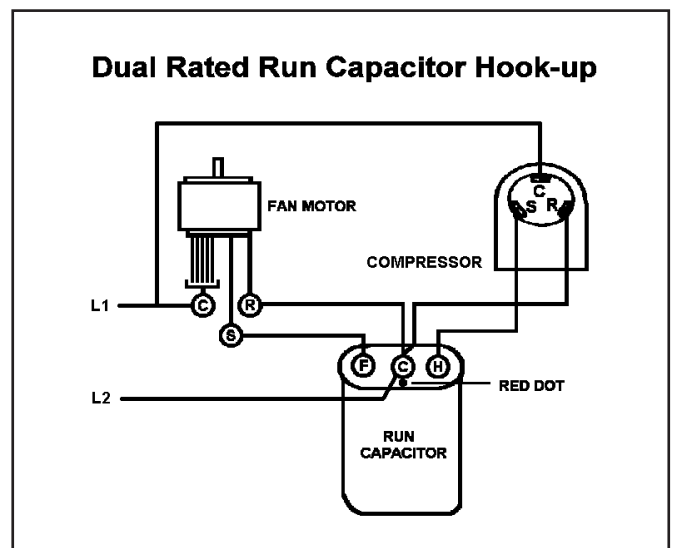

COMPONENTS TESTING (Continued)

HEATER ELEMENTS AND LIMIT SWITCHES' SPECIFICATIONS

All heat pumps and electric heat models are equipped with a heating element and a limit switch (bimetal thermostat). The limit is in series with the element and will interrupt the power at a designed temperature.

Should the blower motor fail, filter become clogged or air-flow be restricted etc., the high limit switch will open and interrupt the power to the heater before reaching an unsafe temperature condition.

TESTING THE HEATING ELEMENTS AND LIMIT SWITCHES

⚠ WARNING	
	ELECTRIC SHOCK HAZARD Disconnect power to the unit before servicing. Failure to follow this warning could result in serious injury or death.

Testing of the heating elements can be made with an ohmmeter or continuity tester across the terminals after the power wires have been removed. Test the limit switch for continuity across its input and output terminals. Test below the limit switch's reset temperature.

DRAIN PAN VALVE

During the cooling mode of operation, condensate which collects in the drain pan is picked up by the condenser fan blade and sprayed onto the condenser coil. This assists in cooling the refrigerant plus evaporating the water.

During the heating mode of operation, it is necessary that water be removed to prevent it from freezing during cold outside temperatures. This could cause the condenser fan blade to freeze in the accumulated water and prevent it from turning.

To provide a means of draining this water, a bellows type drain valve is installed over a drain opening in the base pan.

This valve is temperature sensitive and will open when the outside temperature reaches 40°F. The valve will close gradually as the temperature rises above 40°F to fully close at 60°F.

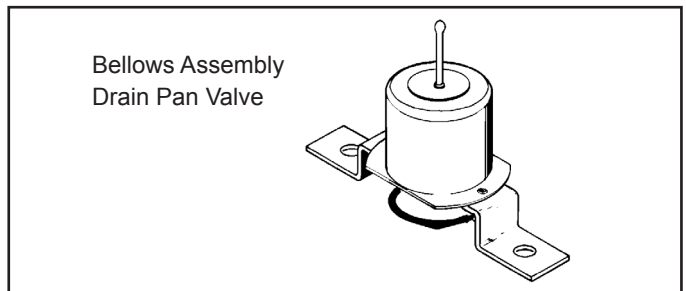

REFRIGERATION SEQUENCE OF OPERATION

A good understanding of the basic operation of the refrigeration system is essential for the service technician. Without this understanding, accurate troubleshooting of refrigeration system problems will be more difficult and time consuming, if not (in some cases) entirely impossible. The refrigeration system uses four basic principles (laws) in its operation they are as follows:

1. "Heat always flows from a warmer body to a cooler body."
2. "Heat must be added to or removed from a substance before a change in state can occur"
3. "Flow is always from a higher pressure area to a lower pressure area."
4. "The temperature at which a liquid or gas changes state is dependent upon the pressure."

The refrigeration cycle begins at the compressor. Starting the compressor creates a low pressure in the suction line which draws refrigerant gas (vapor) into the compressor. The compressor then "compresses" this refrigerant, raising its pressure and its (heat intensity) temperature.

The refrigerant leaves the compressor through the discharge Line as a hot High pressure gas (vapor). The refrigerant enters the condenser coil where it gives up some of its heat. The condenser fan moving air across the coil's finned surface facilitates the transfer of heat from the refrigerant to the relatively cooler outdoor air.

When a sufficient quantity of heat has been removed from the refrigerant gas (vapor), the refrigerant will "condense" (i.e. change to a liquid). Once the refrigerant has been condensed (changed) to a liquid it is cooled even further by the air that continues to flow across the condenser coil.

The VPAK design determines at exactly what point (in the condenser) the change of state (i.e. gas to a liquid) takes place. In all cases, however, the refrigerant must be totally condensed (changed) to a Liquid before leaving the condenser coil.

The refrigerant leaves the condenser Coil through the liquid line as a warm high pressure liquid. It next will pass through the refrigerant drier (if so equipped). It is the function of the drier to trap any moisture present in the system, contaminants, and large particulate matter.

The liquid refrigerant next enters the metering device. The metering device is a capillary tube. The purpose of the metering device is to "meter" (i.e. control or measure) the quantity of refrigerant entering the evaporator coil.

In the case of the capillary tube this is accomplished (by design) through size (and length) of device, and the pressure difference present across the device.

Since the evaporator coil is under a lower pressure (due to the suction created by the compressor) than the liquid line, the liquid refrigerant leaves the metering device entering the evaporator coil. As it enters the evaporator coil, the larger area and lower pressure allows the refrigerant to expand and lower its temperature (heat intensity). This expansion is often referred to as "boiling". Since the unit's blower is moving indoor air across the finned surface of the evaporator coil, the expanding refrigerant absorbs some of that heat. This results in a lowering of the indoor air temperature, hence the "cooling" effect.

The expansion and absorbing of heat cause the liquid refrigerant to evaporate (i.e. change to a gas). Once the refrigerant has been evaporated (changed to a gas), it is heated even further by the air that continues to flow across the evaporator coil.

The particular system design determines at exactly what point (in the evaporator) the change of state (i.e. liquid to a gas) takes place. In all cases, however, the refrigerant must be totally evaporated (changed) to a gas before leaving the evaporator coil.

The low pressure (suction) created by the compressor causes the refrigerant to leave the evaporator through the suction line as a cool low pressure vapor. The refrigerant then returns to the compressor, where the cycle is repeated.

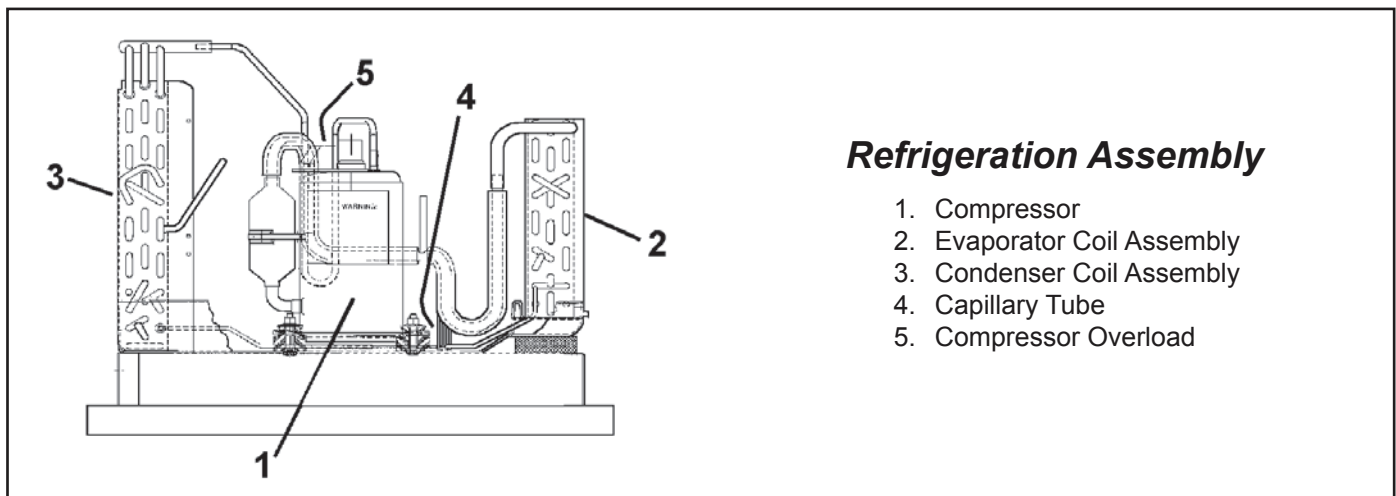

SERVICE

⚠ WARNING



ELECTRIC SHOCK HAZARD

Turn off electric power before service or installation.

Extreme care must be used, if it becomes necessary to work on equipment with power applied.

Failure to do so could result in serious injury or death.

⚠ CAUTION



CUT/SEVER HAZARD

Be careful with the sharp edges and corners. Wear protective clothing and gloves, etc.

Failure to do so could result in minor to moderate injury.

Servicing / Chassis Quick Changeouts

The chassis is designed for quick disconnect and change out. For minor electrical service, the control box cover lifts straight up after the screws & disconnect head are removed. For major electrical, refrigeration and fan service the chassis may be removed from utility closet.

To Remove the Chassis from the Closet:

- A. Disconnect the power coming into the unit from the main breaker panel or the closet mounted disconnect.
- B. Switch the wall Thermostat off.
- C. Pull the Power Disconnect located in the front of the chassis.
- D. Disconnect the electrical connection.
- E. Disconnect the duct work.
- F. Disconnect condensate drain on 9-18,000 BTU models.
- G. Slide the chassis out of the wall plenum.
- H. Lift the chassis out of the utility closet.

Warranty

All service work must be done by a qualified servicer. See Product Warranty, and consult your dealer or contractor for details

SEALED REFRIGERATION SYSTEM REPAIRS

IMPORTANT

ANY SEALED SYSTEM REPAIRS TO COOL-ONLY MODELS REQUIRE THE INSTALLATION OF A LIQUID LINE DRIER. ALSO, ANY SEALED SYSTEM REPAIRS TO HEAT PUMP MODELS REQUIRE THE INSTALLATION OF A SUCTION LINE DRIER.

EQUIPMENT REQUIRED:

1. Voltmeter
2. Ammeter
3. Ohmmeter
4. E.P.A. Approved Refrigerant Recovery System
5. Vacuum Pump (capable of 200 microns or less vacuum.)
6. Acetylene Welder
7. Electronic Halogen Leak Detector capable of detecting HFC (Hydrofluorocarbon) refrigerants.
8. Accurate refrigerant charge measuring device such as:
 - a. Balance Scales - 1/2 oz. accuracy
 - b. Charging Board - 1/2 oz. accuracy
9. High Pressure Gauge - (0 - 750 lbs.)
10. Low Pressure Gauge - (30 - 200 lbs.)
11. Vacuum Gauge - (0 - 1000 microns)
12. Facilities for flowing nitrogen through refrigeration tubing during all brazing processes.

EQUIPMENT MUST BE CAPABLE OF:

1. Recovering refrigerant to EPA required levels.
2. Evacuation from both the high side and low side of the system simultaneously.
3. Introducing refrigerant charge into high side of the system.
4. Accurately weighing the refrigerant charge actually introduced into the system.

⚠ WARNING	
	RISK OF ELECTRIC SHOCK Unplug and/or disconnect all electrical power to the unit before performing inspections, maintenances or service. Failure to do so could result in electric shock, serious injury or death.

Too much refrigerant (overcharge) in the system is just as bad (if not worse) than not enough refrigerant (undercharge). They both can be the source of certain compressor failures if they remain uncorrected for any period of time. Quite often, other problems (such as low air flow across evaporator, etc.) are misdiagnosed as refrigerant charge problems. The refrigerant circuit diagnosis chart will assist you in properly diagnosing these systems.

⚠ WARNING	
	HIGH PRESSURE HAZARD Sealed Refrigeration System contains refrigerant and oil under high pressure. Proper safety procedures must be followed, and proper protective clothing must be worn when working with refrigerants. Failure to follow these procedures could result in serious injury or death.

An overcharged unit will at times return liquid refrigerant (slugging) back to the suction side of the compressor eventually causing a mechanical failure within the compressor. This mechanical failure can manifest itself as valve failure, bearing failure, and/or other mechanical failure. The specific type of failure will be influenced by the amount of liquid being returned, and the length of time the slugging continues.

Not enough refrigerant (undercharge) on the other hand, will cause the temperature of the suction gas to increase to the point where it does not provide sufficient cooling for the compressor motor. When this occurs, the motor winding temperature will increase causing the motor to overheat and possibly cycle open the compressor overload protector. Continued overheating of the motor windings and/or cycling of the overload will eventually lead to compressor motor or overload failure.

Refrigerant Charging

Proper refrigerant charge is essential to proper unit operation. Operating a unit with an improper refrigerant charge will result in reduced performance (capacity) and/or efficiency. Accordingly, the use of proper charging methods during servicing will insure that the unit is functioning as designed and that its compressor will not be damaged.

Method Of Charging / Repairs

The acceptable method for charging the RAC system is the Weighed in Charge Method. The weighed in charge method is applicable to all units. It is the preferred method to use, as it is the most accurate.

The weighed in method should always be used whenever a charge is removed from a unit such as for a leak repair, compressor replacement, or when there is no refrigerant charge left in the unit. To charge by this method, requires the following steps:

1. Install a piercing valve to remove refrigerant from the sealed system. (Piercing valve must be removed from the system before recharging.)
2. Recover Refrigerant in accordance with EPA regulations.

⚠ WARNING	
	<p>BURN HAZARD Proper safety procedures must be followed, and proper protective clothing must be worn when working with a torch.</p> <p>Failure to follow these procedures could result in moderate or serious injury.</p>

3. Install a process tube to sealed system.

⚠ CAUTION	
	<p>FREEZE HAZARD Proper safety procedures must be followed, and proper protective clothing must be worn when working with liquid refrigerant.</p> <p>Failure to follow these procedures could result in minor to moderate injury.</p>

4. Make necessary repairs to system.
5. Evacuate system to 200 microns or less.
6. Weigh in refrigerant with the property quantity of R-410A refrigerant.
7. Start unit, and verify performance.

⚠ WARNING	
	<p>BURN HAZARD Proper safety procedures must be followed, and proper protective clothing must be worn when working with a torch.</p> <p>Failure to follow these procedures could result in moderate or serious injury.</p>

8. Crimp the process tube and solder the end shut.

⚠ WARNING	
	<p>ELECTRIC SHOCK HAZARD Turn off electric power before service or installation.</p> <p>Extreme care must be used, if it becomes necessary to work on equipment with power applied.</p> <p>Failure to do so could result in serious injury or death.</p>

⚠ WARNING	
	<p>HIGH PRESSURE HAZARD Sealed Refrigeration System contains refrigerant and oil under high pressure.</p> <p>Proper safety procedures must be followed, and proper protective clothing must be worn when working with refrigerants.</p> <p>Failure to follow these procedures could result in serious injury or death.</p>

Undercharged Refrigerant Systems

An undercharged system will result in poor performance (low pressures, etc.) in both the heating and cooling cycle.

Whenever you service a unit with an undercharge of refrigerant, always suspect a leak. The leak must be repaired before charging the unit.

To check for an undercharged system, turn the unit on, allow the compressor to run long enough to establish working pressures in the system (15 to 20 minutes).

During the cooling cycle you can listen carefully at the exit of the metering device into the evaporator; an intermittent hissing and gurgling sound indicates a low refrigerant charge. Intermittent frosting and thawing of the evaporator is another indication of a low charge, however, frosting and thawing can also be caused by insufficient air over the evaporator.

Checks for an undercharged system can be made at the compressor. If the compressor seems quieter than normal, it is an indication of a low refrigerant charge.

A check of the amperage drawn by the compressor motor should show a lower reading. (Check the Unit Specification.)

After the unit has run 10 to 15 minutes, check the gauge pressures. Gauges connected to system with an undercharge will have low head pressures and substantially low suction pressures.

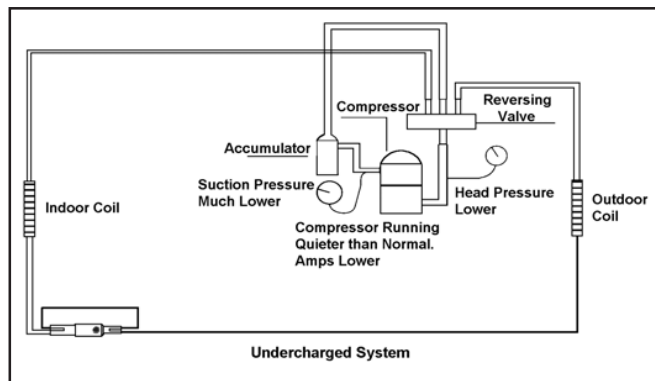

Overcharged Refrigerant Systems

Compressor amps will be near normal or higher. Noncondensables can also cause these symptoms. To confirm, remove some of the charge, if conditions improve, system may be overcharged. If conditions don't improve, Noncondensables are indicated.

Whenever an overcharged system is indicated, always make sure that the problem is not caused by air flow problems.

Improper air flow over the evaporator coil may indicate some of the same symptoms as an overcharged system. An overcharge can cause the compressor to fail, since it would be "slugged" with liquid refrigerant.

The charge for any system is critical. When the compressor is noisy, suspect an overcharge, when you are sure that the air quantity over the evaporator coil is correct. Icing of the evaporator will not be encountered because the refrigerant will boil later if at all. Gauges connected to system will usually have higher head pressure (depending upon amount of overcharge). Suction pressure should be slightly higher.

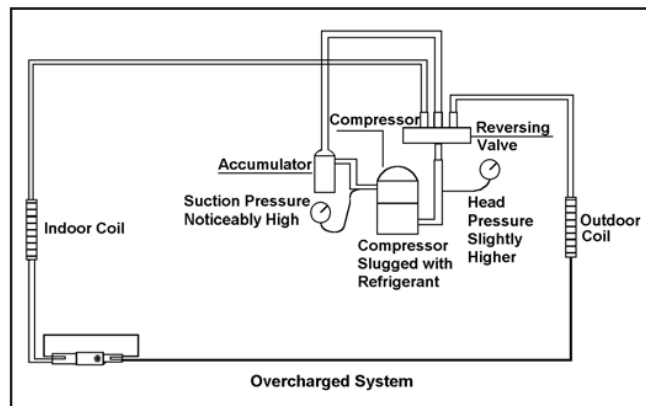

Restricted Refrigerant System

Troubleshooting a restricted refrigerant system can be difficult. The following procedures are the more common problems and solutions to these problems. There are two types of refrigerant restrictions: Partial restrictions and complete restrictions.

A partial restriction allows some of the refrigerant to circulate through the system.

With a complete restriction there is no circulation of refrigerant in the system.

Restricted refrigerant systems display the same symptoms as a "low-charge condition."

When the unit is shut off, the gauges may equalize very slowly.

Gauges connected to a completely restricted system will run in a deep vacuum. When the unit is shut off, the gauges will not equalize at all.

A quick check for either condition begins at the evaporator. With a partial restriction, there may be gurgling sounds at the metering device entrance to the evaporator. The evaporator in a partial restriction could be partially frosted or have an ice ball close to the entrance of the metering device. Frost may continue on the suction line back to the compressor.

Often a partial restriction of any type can be found by feel, as there is a temperature difference from one side of the restriction to the other.

With a complete restriction, there will be no sound at the metering device entrance. An amperage check of the compressor with a partial restriction may show normal current when compared to the unit specification.

With a complete restriction the current drawn may be considerably less than normal, as the compressor is running in a deep vacuum (no load.) Much of the area of the condenser will be relatively cool since most or all of the liquid refrigerant will be stored there.

The following conditions are based primarily on a system in the cooling mode.

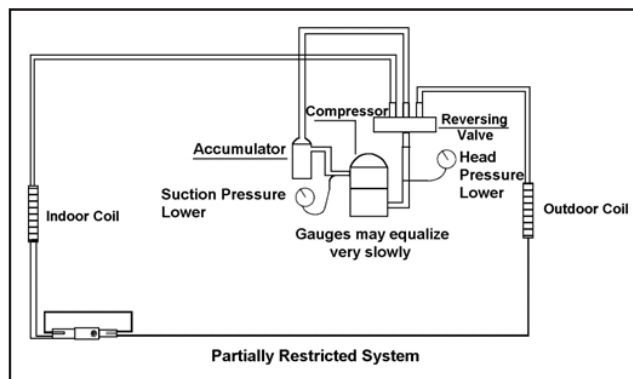
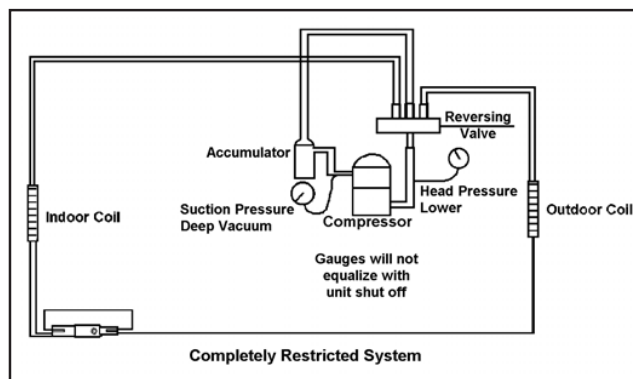

HERMETIC COMPONENTS CHECK

⚠ WARNING

	BURN HAZARD Proper safety procedures must be followed, and proper protective clothing must be worn when working with a torch.
	Failure to follow these procedures could result in moderate or serious injury.

⚠ WARNING

	CUT/SEVER HAZARD Be careful with the sharp edges and corners. Wear protective clothing and gloves, etc.
	Failure to do so could result in serious injury.

METERING DEVICE

Capillary Tube Systems

All units are equipped with capillary tube metering devices.

Checking for restricted capillary tubes.

1. Connect pressure gauges to unit.
2. Start the unit in the cooling mode. If after a few minutes of operation the pressures are normal, the check valve and the cooling capillary are not restricted.

3. Switch the unit to the heating mode and observe the gauge readings after a few minutes running time. If the system pressure is lower than normal, the heating capillary is restricted.
4. If the operating pressures are lower than normal in both the heating and cooling mode, the cooling capillary is restricted.

CHECK VALVE

A unique two-way check valve is used on the reverse cycle heat pumps. It is pressure operated and used to direct the flow of refrigerant through a single filter drier and to the proper capillary tube during either the heating or cooling cycle.

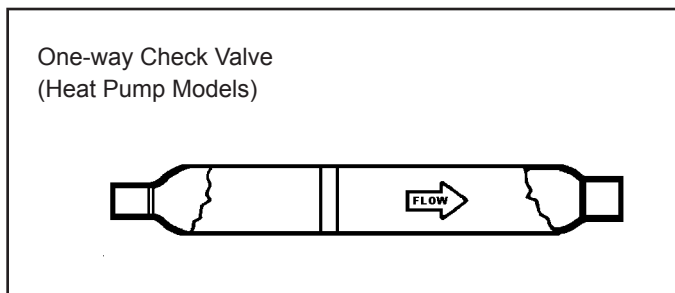

NOTE: The slide (check) inside the valve is made of teflon. Should it become necessary to replace the check valve, place a wet cloth around the valve to prevent overheating during the brazing operation.

CHECK VALVE OPERATION

In the cooling mode of operation, high pressure liquid enters the check valve forcing the slide to close the opposite port (liquid line) to the indoor coil. Refer to refrigerant flow chart. This directs the refrigerant through the filter drier and cooling capillary tube to the indoor coil.

In the heating mode of operation, high pressure refrigerant enters the check valve from the opposite direction, closing

the port (liquid line) to the outdoor coil. The flow path of the refrigerant is then through the filter drier and heating capillary to the outdoor coil.

Failure of the slide in the check valve to seat properly in either mode of operation will cause flooding of the cooling coil. This is due to the refrigerant bypassing the heating or cooling capillary tube and entering the liquid line.

COOLING MODE

In the cooling mode of operation, liquid refrigerant from condenser (liquid line) enters the cooling check valve forcing the heating check valve shut. The liquid refrigerant is directed into the liquid dryer after which the refrigerant is metered through cooling capillary tubes to evaporator. (Note: liquid refrigerant will also be directed through the heating capillary tubes in a continuous loop during the cooling mode).

HEATING MODE

In the heating mode of operation, liquid refrigerant from the indoor coil enters the heating check valve forcing the cooling check valve shut. The liquid refrigerant is directed into the liquid dryer after which the refrigerant is metered through the heating capillary tubes to outdoor coils. (Note: liquid refrigerant will also be directed through the cooling capillary tubes in a continuous loop during the heating mode).

REVERSING VALVE DESCRIPTION/OPERATION

⚠ WARNING



ELECTRIC SHOCK HAZARD

Disconnect power to the unit before servicing. Failure to follow this warning could result in serious injury or death.

The Reversing Valve controls the direction of refrigerant flow to the indoor and outdoor coils. It consists of a pressure-operated, main valve and a pilot valve actuated by a solenoid plunger. The solenoid is energized during the heating cycle only. The reversing valves used in the PTAC system is a 2-position, 4-way valve.

The single tube on one side of the main valve body is the high-pressure inlet to the valve from the compressor. The center tube on the opposite side is connected to the low pressure (suction) side of the system. The other two are connected to the indoor and outdoor coils. Small capillary tubes connect each end of the main valve cylinder to the “A” and “B” ports of the pilot valve. A third capillary is a common return line from these ports to the suction tube on the main valve body. Four-way reversing valves also have a capillary tube from the compressor discharge tube to the pilot valve.

The piston assembly in the main valve can only be shifted by the pressure differential between the high and low sides

of the system. The pilot section of the valve opens and closes ports for the small capillary tubes to the main valve to cause it to shift.

NOTE: System operating pressures must be near normal before valve can shift.

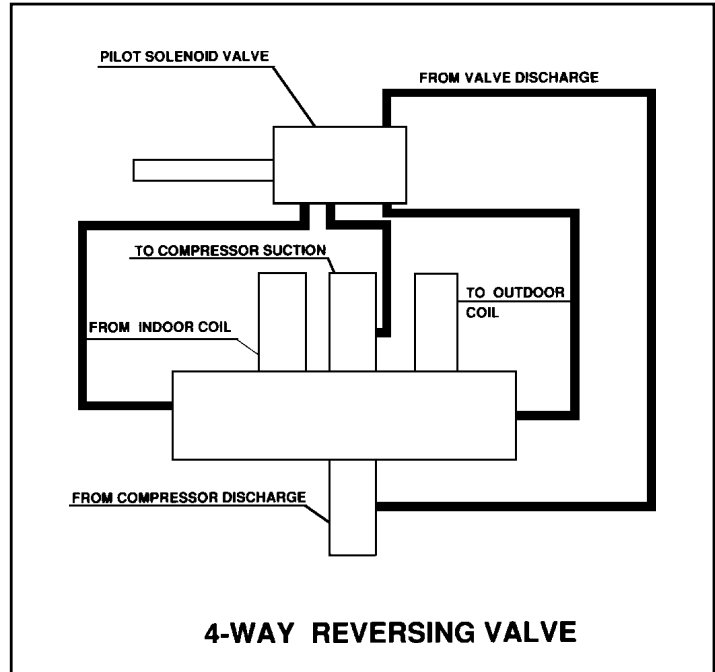

4-WAY REVERSING VALVE

TESTING THE COIL

⚠ WARNING



ELECTRIC SHOCK HAZARD

Unplug and/or disconnect all electrical power to the unit before performing inspections, maintenances or service.

Failure to do so could result in electric shock, serious injury or death.

The solenoid coil is an electromagnetic type coil mounted on the reversing valve and is energized during the operation of the compressor in the heating cycle.

1. Turn off high voltage electrical power to unit.
2. Unplug line voltage lead from reversing valve coil.
3. Check for electrical continuity through the coil. If you do not have continuity replace the coil.
4. Check from each lead of coil to the copper liquid line as it leaves the unit or the ground lug. There should be no continuity between either of the coil leads and ground; if there is, coil is grounded and must be replaced.
5. If coil tests okay, reconnect the electrical leads.
6. Make sure coil has been assembled correctly.

NOTE: Do not start unit with solenoid coil removed from valve, or do not remove coil after unit is in operation. This will cause the coil to burn out.

CHECKING THE REVERSING VALVE

NOTE: You must have normal operating pressures before the reversing valve can shift.

⚠ WARNING

HIGH PRESSURE HAZARD

Sealed Refrigeration System contains refrigerant and oil under high pressure.

Proper safety procedures must be followed, and proper protective clothing must be worn when working with refrigerants.

Failure to follow these procedures could result in serious injury or death.



Check the operation of the valve by starting the system and switching the operation from “Cooling” to “Heating” and then back to “Cooling”. Do not hammer on valve.

Occasionally, the reversing valve may stick in the heating or cooling position or in the mid-position.

When sluggish or stuck in the mid-position, part of the discharge gas from the compressor is directed back to the suction side, resulting in excessively high suction pressure.

Should the valve fail to shift from cooling to heating, block the air flow through the outdoor coil and allow the discharge pressure to build in the system. Then switch the system from heating to cooling.

If the valve is stuck in the heating position, block the air flow through the indoor coil and allow discharge pressure to build in the system. Then switch the system from heating to cooling.

Should the valve fail to shift in either position after increasing the discharge pressure, replace the valve.

Dented or damaged valve body or capillary tubes can prevent the main slide in the valve body from shifting.

If you determine this is the problem, replace the reversing valve.

After all of the previous inspections and checks have been made and determined correct, then perform the "Touch Test" on the reversing valve.

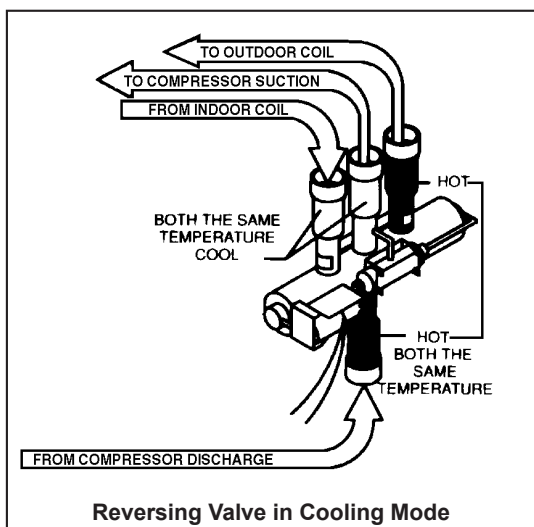
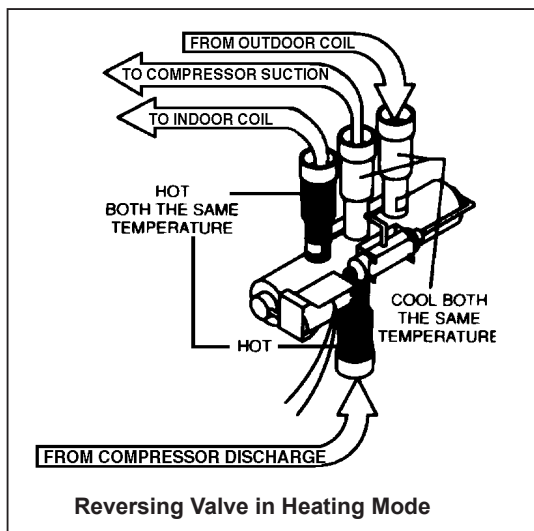

Touch Test in Heating/Cooling Cycle

⚠ WARNING	
	<p>BURN HAZARD</p> <p>Certain unit components operate at temperatures hot enough to cause burns.</p> <p>Proper safety procedures must be followed, and proper protective clothing must be worn.</p> <p>Failure to follow these procedures could result in minor to moderate injury.</p>

The only definite indications that the slide is in the mid-position is if all three tubes on the suction side of the valve are hot after a few minutes of running time.

NOTE: A condition other than those illustrated above, and on Page 31, indicate that the reversing valve is not shifting properly. Both tubes shown as hot or cool must be the same corresponding temperature.

Procedure For Changing Reversing Valve

⚠ WARNING	
	<p>HIGH PRESSURE HAZARD</p> <p>Sealed Refrigeration System contains refrigerant and oil under high pressure.</p> <p>Proper safety procedures must be followed, and proper protective clothing must be worn when working with refrigerants.</p> <p>Failure to follow these procedures could result in serious injury or death.</p>

NOTICE	
<p>FIRE HAZARD</p> <p>The use of a torch requires extreme care and proper judgment. Follow all safety recommended precautions and protect surrounding areas with fire proof materials. Have a fire extinguisher readily available. Failure to follow this notice could result in moderate to serious property damage.</p>	

1. Install Process Tubes. Recover refrigerant from sealed system. PROPER HANDLING OF RECOVERED REFRIGERANT ACCORDING TO EPA REGULATIONS IS REQUIRED.
2. Remove solenoid coil from reversing valve. If coil is to be reused, protect from heat while changing valve.
3. Unbraid all lines from reversing valve.
4. Clean all excess braze from all tubing so that they will slip into fittings on new valve.
5. Remove solenoid coil from new valve.

6. Protect new valve body from heat while brazing with plastic heat sink (Thermo Trap) or wrap valve body with wet rag.
7. Fit all lines into new valve and braze lines into new valve.

⚠ WARNING	
	<p>EXPLOSION HAZARD</p> <p>The use of nitrogen requires a pressure regulator. Follow all safety procedures and wear protective safety clothing etc.</p> <p>Failure to follow proper safety procedures could result in serious injury or death.</p>

8. Pressurize sealed system with a combination of R-22 and nitrogen and check for leaks, using a suitable leak detector. Recover refrigerant per EPA guidelines.
9. Once the sealed system is leak free, install solenoid coil on new valve and charge the sealed system by weighing in the proper amount and type of refrigerant as shown on rating plate. Crimp the process tubes and solder the ends shut. Do not leave Schrader or piercing valves in the sealed system.

NOTE: When brazing a reversing valve into the system, it is of extreme importance that the temperature of the valve does not exceed 250°F at any time.

Wrap the reversing valve with a large rag saturated with water. “Re-wet” the rag and thoroughly cool the valve after each brazing operation of the four joints involved.

The wet rag around the reversing valve will eliminate conduction of heat to the valve body when brazing the line connection.

COMPRESSOR CHECKS

⚠ WARNING	
	<p>ELECTRIC SHOCK HAZARD</p> <p>Turn off electric power before service or installation. Extreme care must be used, if it becomes necessary to work on equipment with power applied.</p> <p>Failure to do so could result in serious injury or death.</p>

Locked Rotor Voltage (L.R.V.) Test

Locked rotor voltage (L.R.V.) is the actual voltage available at the compressor under a stalled condition.

Single Phase Connections

Disconnect power from unit. Using a voltmeter, attach one lead of the meter to the run “R” terminal on the compressor and the other lead to the common “C” terminal of the compressor. Restore power to unit.

Determine L.R.V.

Start the compressor with the volt meter attached; then stop the unit. Attempt to restart the compressor within a couple of seconds and immediately read the voltage on the meter. The compressor under these conditions will not start and will usually kick out on overload within a few seconds since the pressures in the system will not have had time to equalize. Voltage should be at or above minimum voltage of 197 VAC, as specified on the rating plate. If less than minimum, check for cause of inadequate power supply; i.e., incorrect wire size, loose electrical connections, etc.

Amperage (L.R.A.) Test

The running amperage of the compressor is the most important of these readings. A running amperage higher than that indicated in the performance data indicates that a problem exists mechanically or electrically.

Single Phase Running and L.R.A. Test

NOTE: Consult the specification and performance section for running amperage. The L.R.A. can also be found on the rating plate.

Select the proper amperage scale and clamp the meter probe around the wire to the “C” terminal of the compressor.

Turn on the unit and read the running amperage on the meter. If the compressor does not start, the reading will indicate the locked rotor amperage (L.R.A.).

Overloads

The compressor is equipped with an external or internal overload which senses both motor amperage and winding temperature. High motor temperature or amperage heats the overload causing it to open, breaking the common circuit within the compressor.

Heat generated within the compressor shell, usually due to recycling of the motor, is slow to dissipate. It may take anywhere from a few minutes to several hours for the overload to reset.

Checking the Overload

⚠ WARNING	
	<p>ELECTRIC SHOCK HAZARD</p> <p>Turn off electric power before service or installation. Extreme care must be used, if it becomes necessary to work on equipment with power applied.</p> <p>Failure to do so could result in serious injury or death.</p>

⚠ WARNING



BURN HAZARD
 Certain unit components operate at temperatures hot enough to cause burns.

Proper safety procedures must be followed, and proper protective clothing must be worn.

Failure to follow this warning could result in moderate to serious injury.

External Overload VPAK 9, 12, 18 K Btus

With power off, remove the leads from compressor terminals. If the compressor is hot, allow the overload to cool before starting check. Using an ohmmeter, test continuity across the terminals of the external overload. If you do not have continuity; this indicates that the overload is open and must be replaced.

Internal Overload VPAK 24 K Btus

The overload is embedded in the motor windings to sense the winding temperature and/or current draw. The overload is connected in series with the common motor terminal.

1. With no power to unit, remove the leads from the compressor terminals. Allow motor to cool.
2. Using an ohmmeter, test continuity between terminals C-S and C-R. If no continuity, the compressor overload is open and the compressor must be replaced.

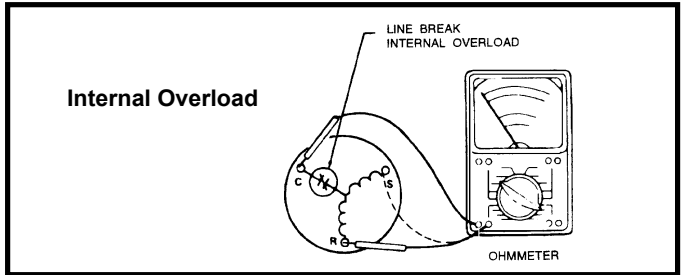

Single Phase Resistance Test

⚠ WARNING



ELECTRIC SHOCK HAZARD
 Turn off electric power before service or installation. Extreme care must be used, if it becomes necessary to work on equipment with power applied.

Failure to do so could result in serious injury or death.

Remove the leads from the compressor terminals and set the ohmmeter on the lowest scale (R x 1).

Touch the leads of the ohmmeter from terminals common to start ("C" to "S"). Next, touch the leads of the ohmmeter from terminals common to run ("C" to "R").

Add values "C" to "S" and "C" to "R" together and check resistance from start to run terminals ("S" to "R"). Resistance "S" to "R" should equal the total of "C" to "S" and "C" to "R."

In a single phase PSC compressor motor, the highest value will be from the start to the run connections ("S" to "R"). The next highest resistance is from the start to the common connections ("S" to "C"). The lowest resistance is from the run to common. ("C" to "R") Before replacing a compressor, check to be sure it is defective.

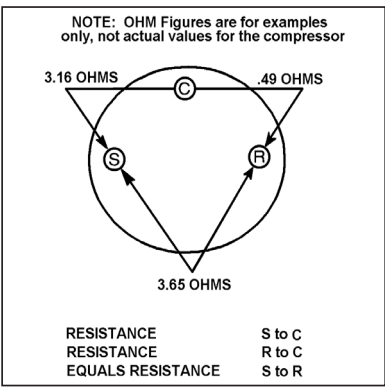

GROUND TEST

Use an ohmmeter set on its highest scale. Touch one lead to the compressor body (clean point of contact as a good connection is a must) and the other probe in turn to each compressor terminal. If a reading is obtained the compressor is grounded and must be replaced.

Check the complete electrical system to the compressor and compressor internal electrical system, check to be certain that compressor is not out on internal overload.

Complete evaluation of the system must be made whenever you suspect the compressor is defective. If the compressor has been operating for sometime, a careful examination must be made to determine why the compressor failed.

Many compressor failures are caused by the following conditions:

1. Improper air flow over the evaporator.
2. Overcharged refrigerant system causing liquid to be returned to the compressor.
3. Restricted refrigerant system.
4. Lack of lubrication.
5. Liquid refrigerant returning to compressor causing oil to be washed out of bearings.
6. Noncondensables such as air and moisture in the system. Moisture is extremely destructive to a refrigerant system.

COMPRESSOR REPLACEMENT

Recommended procedure for compressor replacement

⚠ WARNING	
	RISK OF ELECTRIC SHOCK Unplug and/or disconnect all electrical power to the unit before performing inspections, maintenances or service.
	Failure to do so could result in electric shock, serious injury or death.

1. Be certain to perform all necessary electrical and refrigeration tests to be sure the compressor is actually defective before replacing.

⚠ WARNING	
	HIGH PRESSURE HAZARD Sealed Refrigeration System contains refrigerant and oil under high pressure.
	Proper safety procedures must be followed, and proper protective clothing must be worn when working with refrigerants.
	Failure to follow these procedures could result in serious injury or death.

2. Recover all refrigerant from the system though the process tubes. **PROPER HANDLING OF RECOVERED REFRIGERANT ACCORDING TO EPA REGULATIONS IS REQUIRED.** Do not use gauge manifold for this purpose if there has been a burnout. You will contaminate your manifold and hoses. Use a Schrader valve adapter and copper tubing for burnout failures.

⚠ WARNING	
	HIGH TEMPERATURES Extreme care, proper judgment and all safety procedures must be followed when testing, troubleshooting, handling or working around unit while in operation with high temperature components. Wear protective safety aids such as: gloves, clothing etc.
	Failure to do so could result in serious burn injury.

NOTICE	
FIRE HAZARD	
The use of a torch requires extreme care and proper judgment. Follow all safety recommended precautions and protect surrounding areas with fire proof materials. Have a fire extinguisher readily available. Failure to follow this notice could result in moderate to serious property damage.	

3. After all refrigerant has been recovered, disconnect suction and discharge lines from the compressor and remove compressor. Be certain to have both suction and discharge process tubes open to atmosphere.
4. Carefully pour a small amount of oil from the suction stub of the defective compressor into a clean container.
5. Using an acid test kit (one shot or conventional kit), test the oil for acid content according to the instructions with the kit.
6. If any evidence of a burnout is found, no matter how slight, the system will need to be cleaned up following proper procedures.
7. Install the replacement compressor.

⚠ WARNING	
	EXPLOSION HAZARD The use of nitrogen requires a pressure regulator. Follow all safety procedures and wear protective safety clothing etc.
	Failure to follow proper safety procedures result in serious injury or death.

8. Pressurize with a combination of R-410A and nitrogen and leak test all connections with leak detector capable of detecting HFC (Hydrofluorocarbon) refrigerant. Recover refrigerant/nitrogen mixture and repair any leaks found.

Repeat Step 8 to insure no more leaks are present.

9. Evacuate the system with a good vacuum pump capable of a final vacuum of 200 microns or less. The system should be evacuated through both liquid line and suction line gauge ports. While the unit is being evacuated, seal all openings on the defective compressor.

⚠ CAUTION	
	FREEZE HAZARD Proper safety procedures must be followed, and proper protective clothing must be worn when working with liquid refrigerant.
	Failure to follow these procedures could result in minor to moderate injury.

10. Recharge the system with the correct amount of refrigerant. The proper refrigerant charge will be found on the unit rating plate. The use of an accurate measuring device, such as a charging cylinder, electronic scales or similar device is necessary.

NOTICE	
NEVER , under any circumstances, charge a rotary compressor through the LOW side. Doing so would cause permanent damage to the new compressor.	

SPECIAL PROCEDURE IN THE CASE OF MOTOR COMPRESSOR BURNOUT

⚠ WARNING	
	ELECTRIC SHOCK HAZARD Turn off electric power before service or installation. Failure to do so may result in personal injury, or death.

⚠ WARNING	
	HIGH PRESSURE HAZARD Sealed Refrigeration System contains refrigerant and oil under high pressure. Proper safety procedures must be followed, and proper protective clothing must be worn when working with refrigerants. Failure to follow these procedures could result in serious injury or death.

⚠ WARNING	
	EXPLOSION HAZARD The use of nitrogen requires a pressure regulator. Follow all safety procedures and wear protective safety clothing etc. Failure to follow proper safety procedures result in serious injury or death.

1. Recover all refrigerant and oil from the system.
2. Remove compressor, capillary tube and filter drier from the system.
3. Flush evaporator condenser and all connecting tubing with dry nitrogen or equivalent. Use approved flushing agent to remove all contamination from system. Inspect suction and discharge line for carbon deposits. Remove and clean if necessary. Ensure all acid is neutralized.
4. Reassemble the system, including new drier strainer and capillary tube.
5. Proceed with step 8-10 on previous page.

ROUTINE MAINTENANCE

⚠ WARNING	
	ELECTRICAL SHOCK HAZARD! Turn off electrical power before service or installation. All electrical connections and wiring MUST be installed by a qualified electrician and conform to the National Code and all local codes which have jurisdiction. Failure to do so can result in property damage, personal injury and/or death.

To ensure proper unit operation and life expectancy, the following maintenance procedures should be performed on a regular basis

1. Air Filter

To ensure proper unit operation, the air filters should be cleaned at least monthly, and more frequently if conditions warrant. The unit must be turned off before the filters are cleaned.

To remove the air filters, grasp the top of the filter and lift out of the front cabinet. Reverse the procedure to reinstall the filters.

Clean the filters with a mild detergent in warm water, and allow them to dry thoroughly before reinstalling.

2. Coils & Chassis

NOTE: Do not use a caustic coil cleaning agent on coils or base pan. Use a biodegradable cleaning agent and degreaser. The use of harsh cleaning materials may lead to deterioration of the aluminum fins or the coil end plates.

The indoor coil and outdoor coils and base pan should be inspected periodically (annually or semi-annually) and cleaned of all debris (lint, dirt, leaves, paper, etc.) as necessary. Under extreme conditions, more frequent cleaning may be required. Clean the coils and base pan with a soft brush and compressed air or vacuum. A pressure washer may also be used, however, you must be careful not to bend the aluminum fin pack. Use a sweeping up and down motion in the direction of the vertical aluminum fin pack when pressure cleaning coils.

Note: It is extremely important to insure that none of the electrical and/or electronic parts of the unit get wet. Be sure to cover all electrical components to protect them from water or spray.

3. Decorative Front

The decorative front and discharge air grille may be cleaned with a mild soap or detergent. Do NOT use solvents or hydrocarbon based cleaners such as acetone, naphtha, gasoline, benzene, etc., to clean the decorative front or air discharge grilles.

Use a damp (not wet) cloth when cleaning the control area to prevent water from entering the unit, and possibly damaging the electronic control

4. Fan Motor & Compressor

The fan motor & compressor are permanently lubricated, and require no additional lubrication.

5. Wall Sleeve

Inspect the inside of the wall sleeve and drain system periodically (annually or semi-annually) and clean as required. Under extreme conditions, more frequent cleaning may be necessary. Clean both of these areas with an antibacterial and antifungal cleaner. Rinse both items thoroughly with water and ensure that the drain outlets are operating properly.

ELECTRICAL TROUBLESHOOTING CHART - COOLING

9K BTU, 12K BTU, & 18K BTU

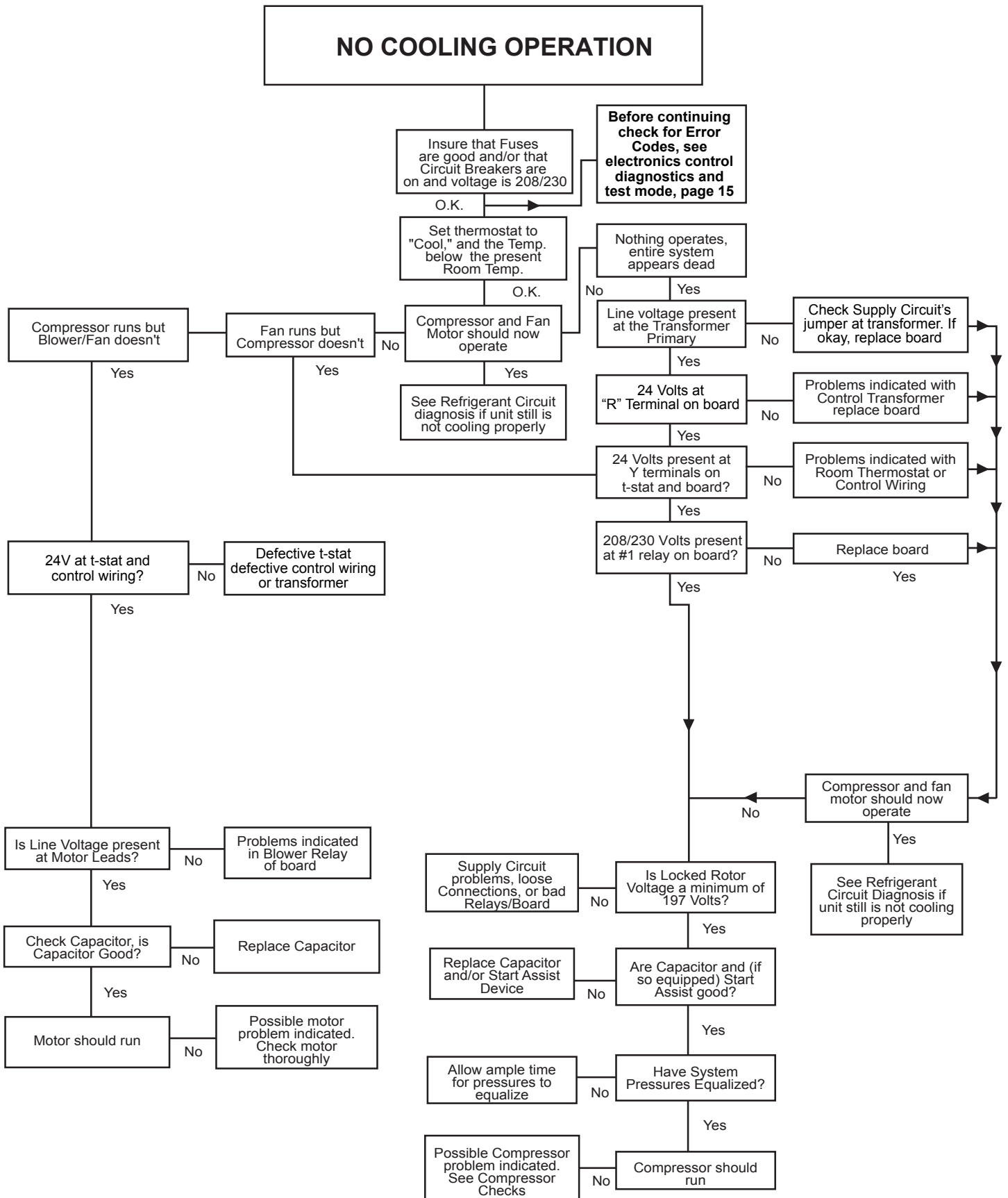

ELECTRICAL TROUBLESHOOTING CHART - COOLING 24K BTU

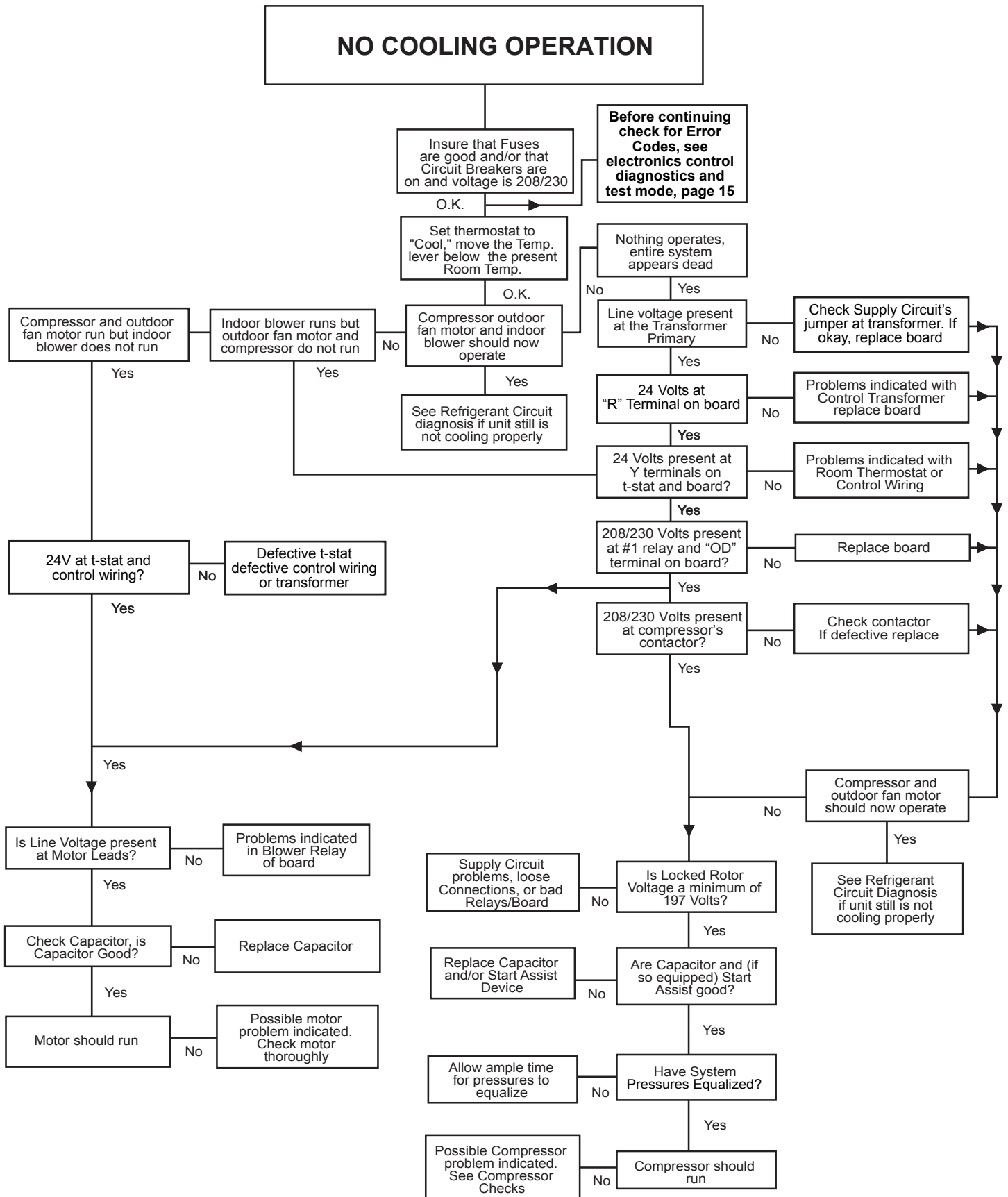

ELECTRICAL TROUBLESHOOTING CHART HEAT PUMP

HEAT PUMP MODE

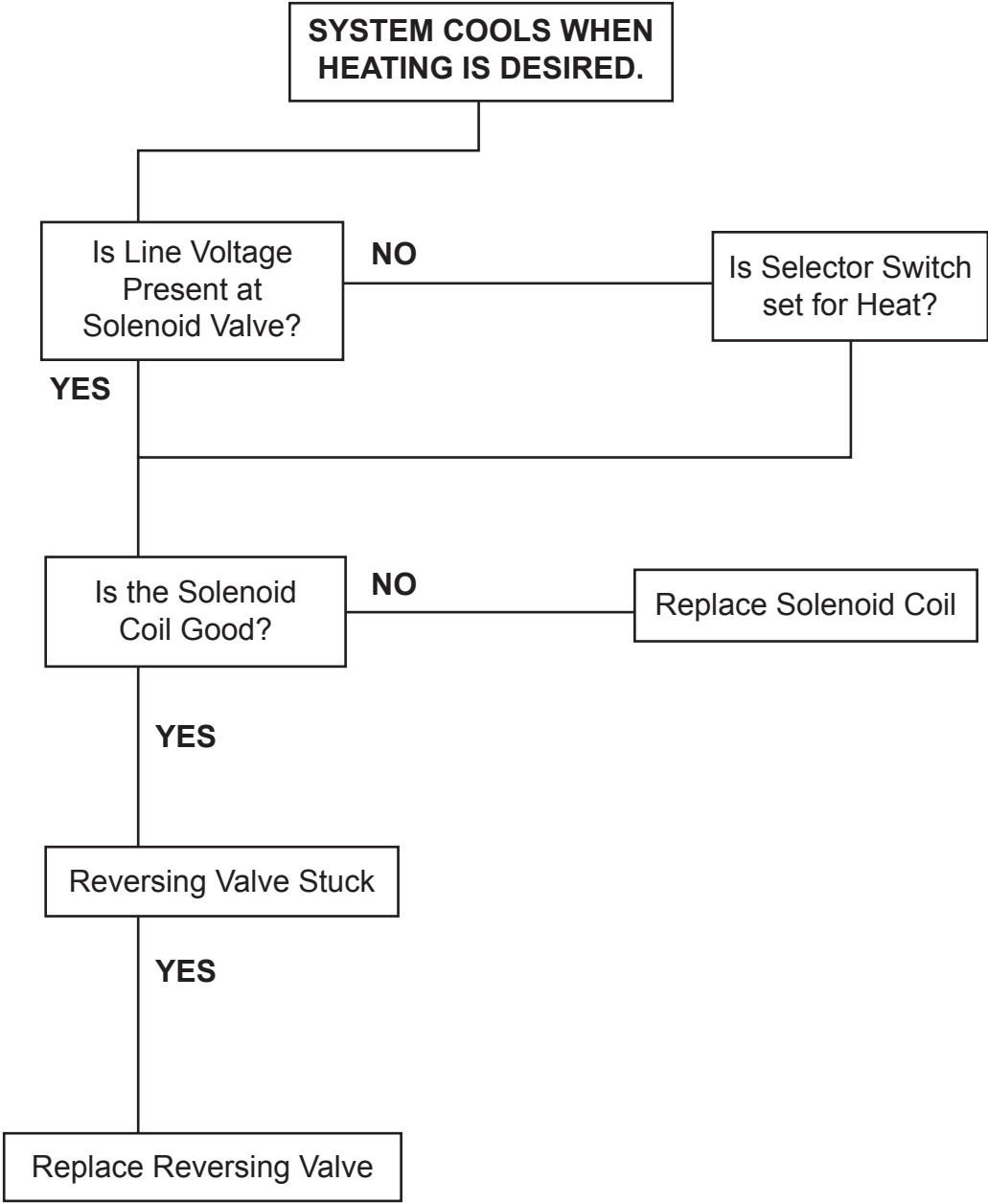

TROUBLESHOOTING CHART - COOLING

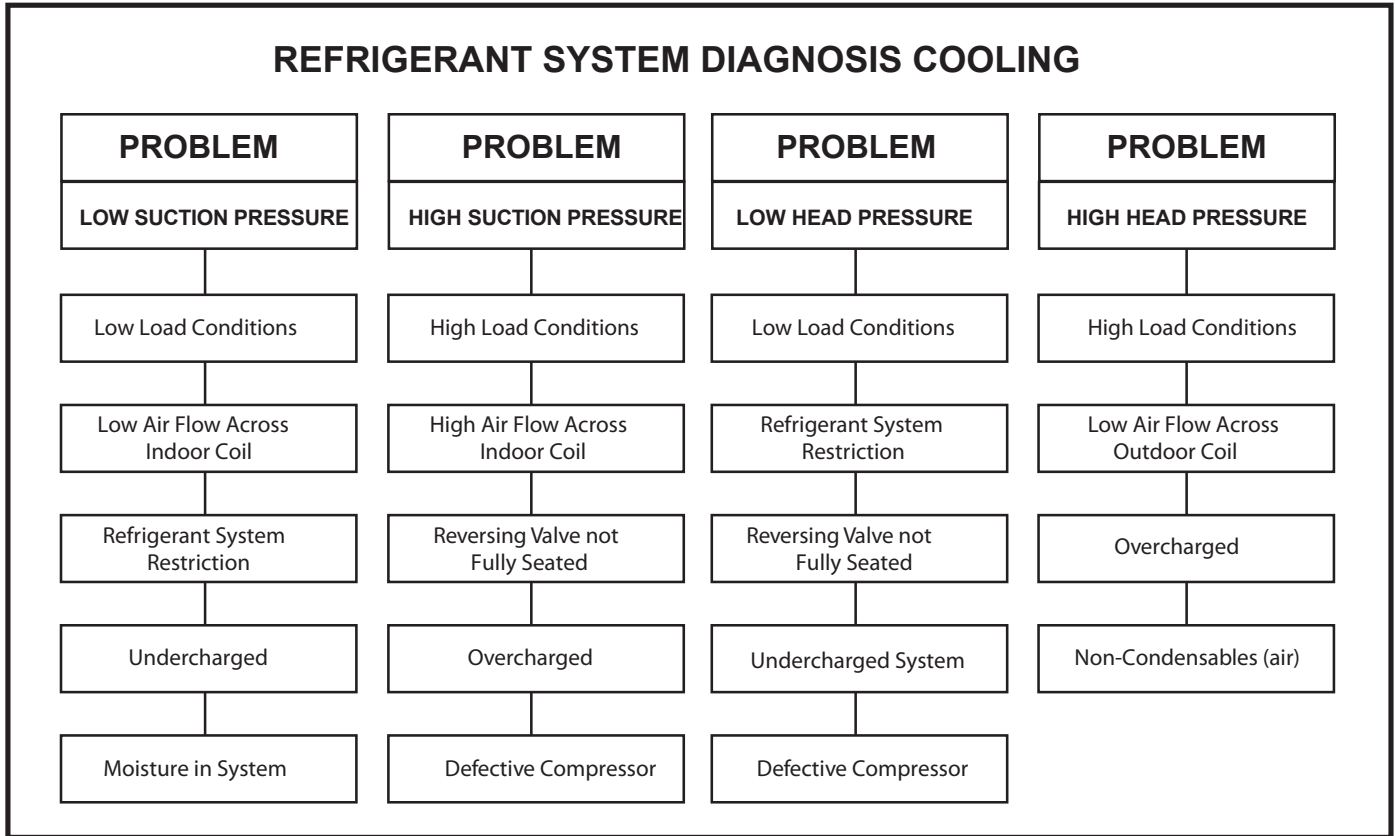

TROUBLESHOOTING CHART - HEATING

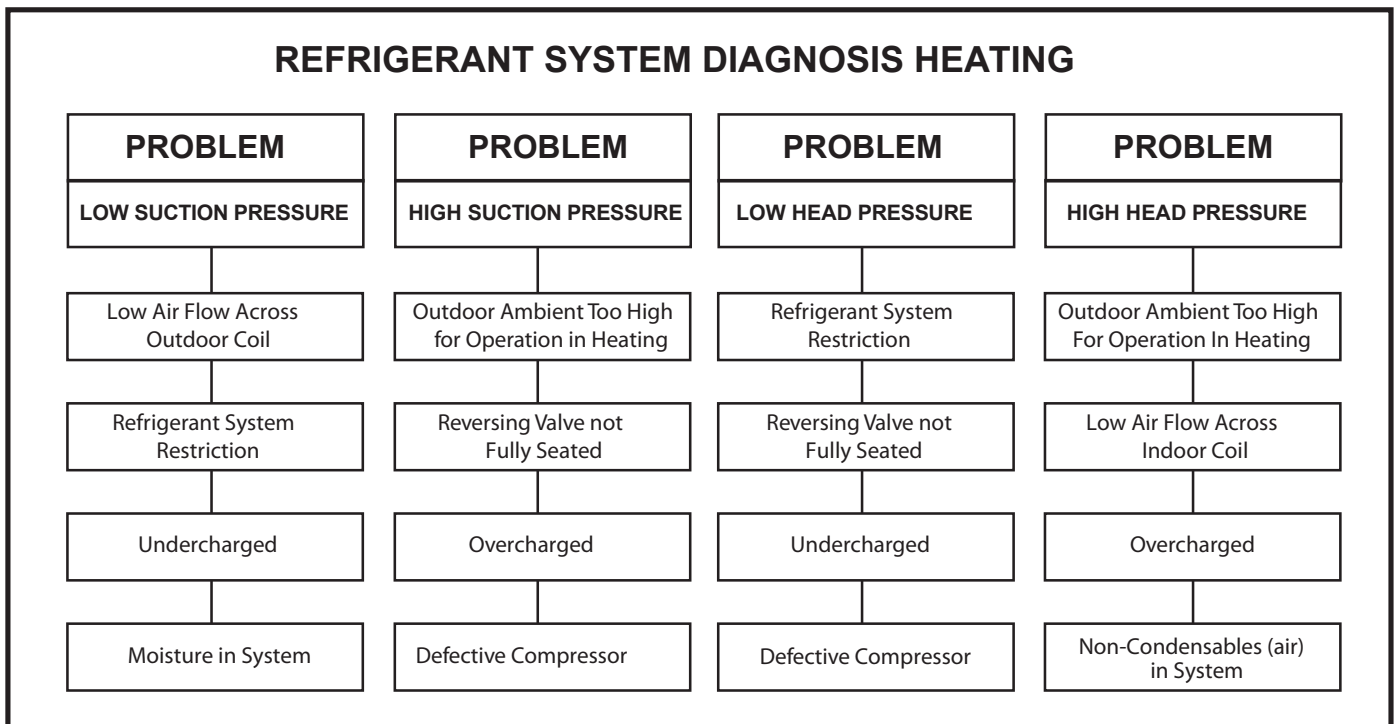

COOL WITH ELECTRIC HEAT ELECTRICAL & THERMOSTAT WIRING DIAGRAM VEA 09/12/18 with 2.5 KW, 3.4 KW or 5KW ELECTRIC HEAT

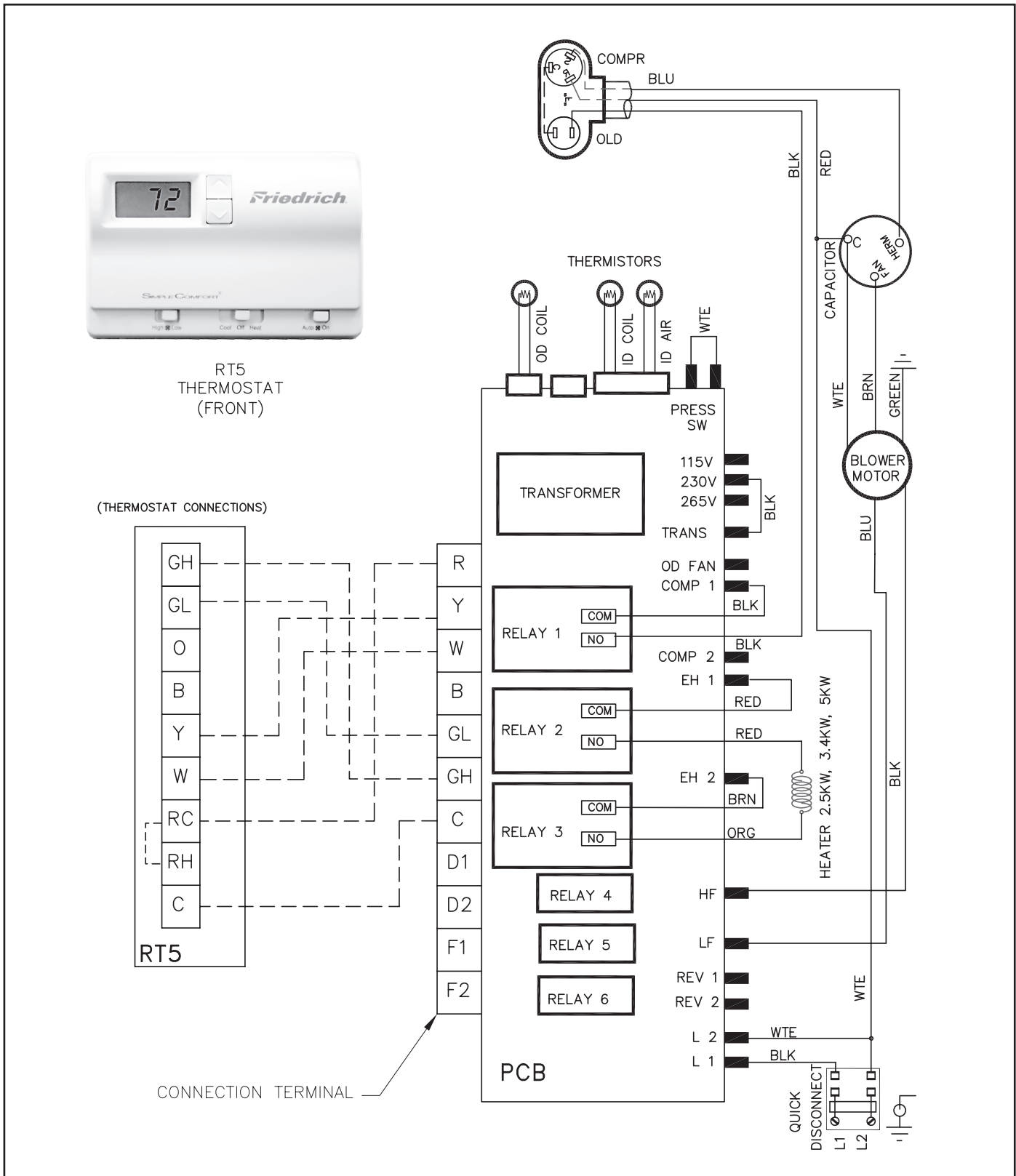

NOTE: THE DIAGRAM ABOVE, ILLUSTRATES THE TYPICAL THERMOSTAT WIRING FOR TWO SPEED FAN OPERATION. SEE THE UNIT CONTROL PANEL FOR THE ACTUAL UNIT WIRING DIAGRAM AND SCHEMATIC.

HEAT PUMP WITH ELECTRIC HEAT ELECTRICAL & THERMOSTAT WIRING DIAGRAM VHA 09/12/18 with 2.5 KW, 3.4 KW or 5KW ELECTRIC HEAT

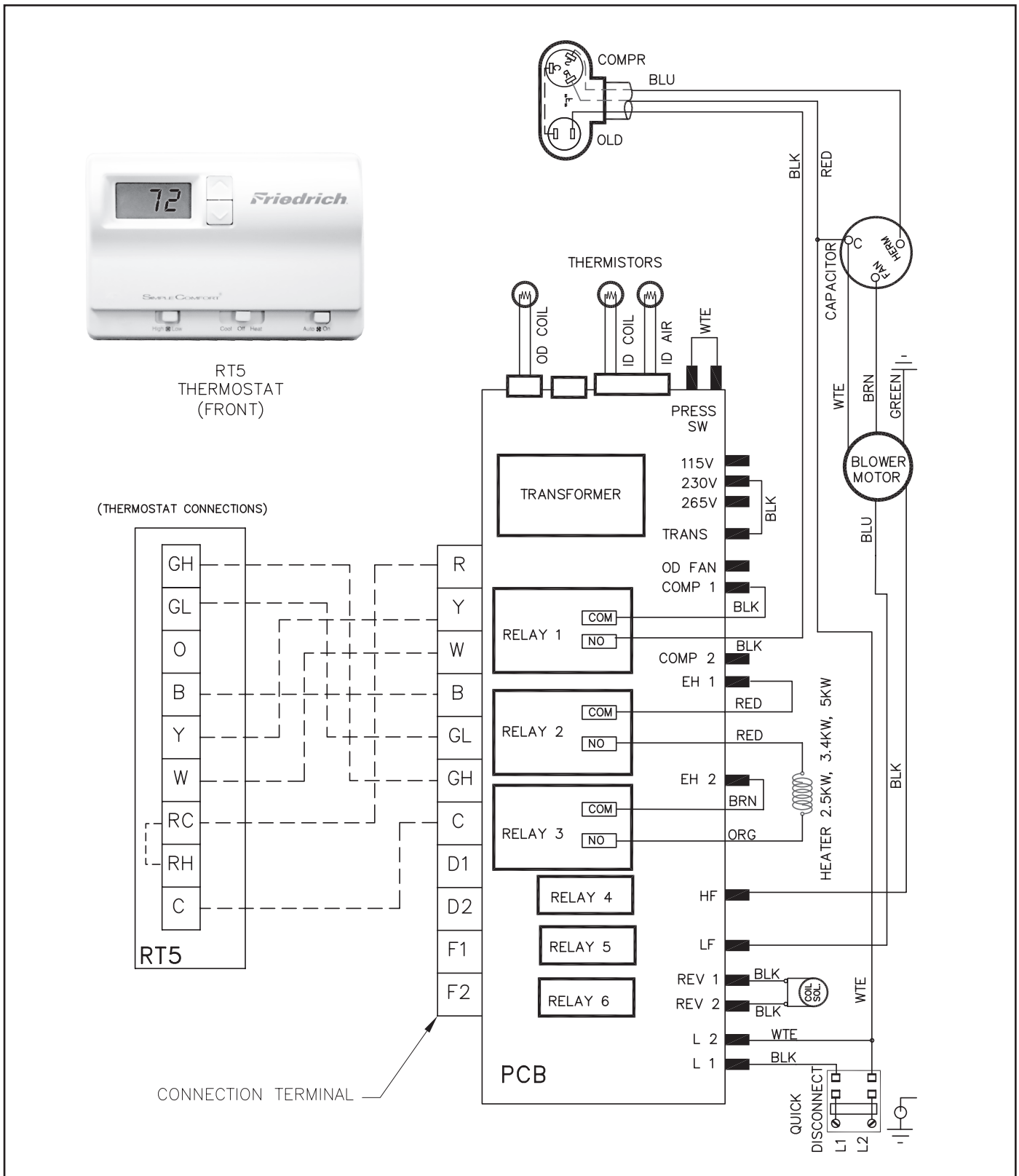

COOL WITH ELECTRIC HEAT ELECTRICAL & THERMOSTAT WIRING DIAGRAM VEA 24 with 2.5 KW, 3.4 KW or 5KW ELECTRIC HEAT

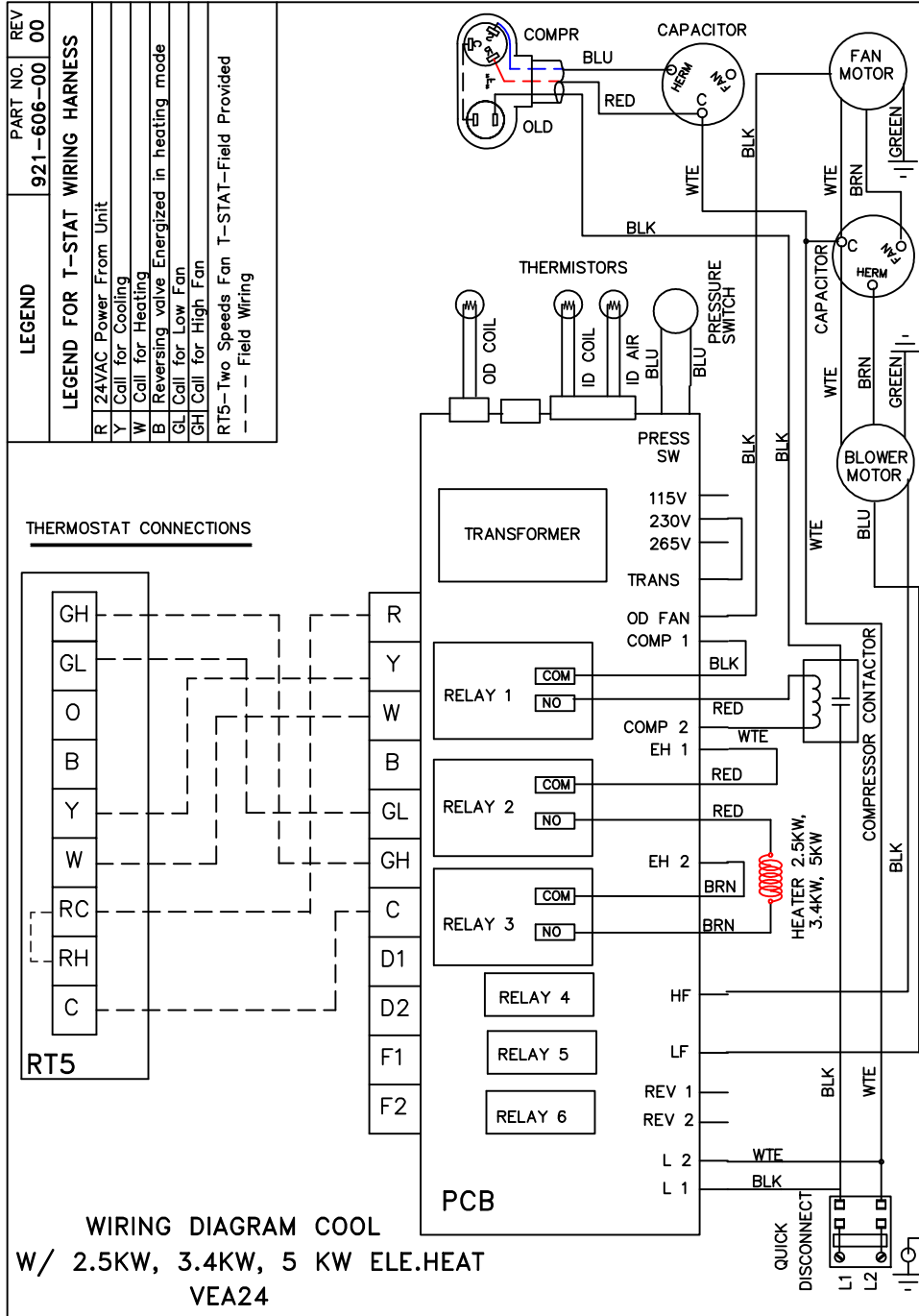

HEAT PUMP WITH ELECTRIC HEAT ELECTRICAL & THERMOSTAT WIRING DIAGRAM VHA 24 with 2.5 KW, 3.4 KW or 5KW ELECTRIC HEAT

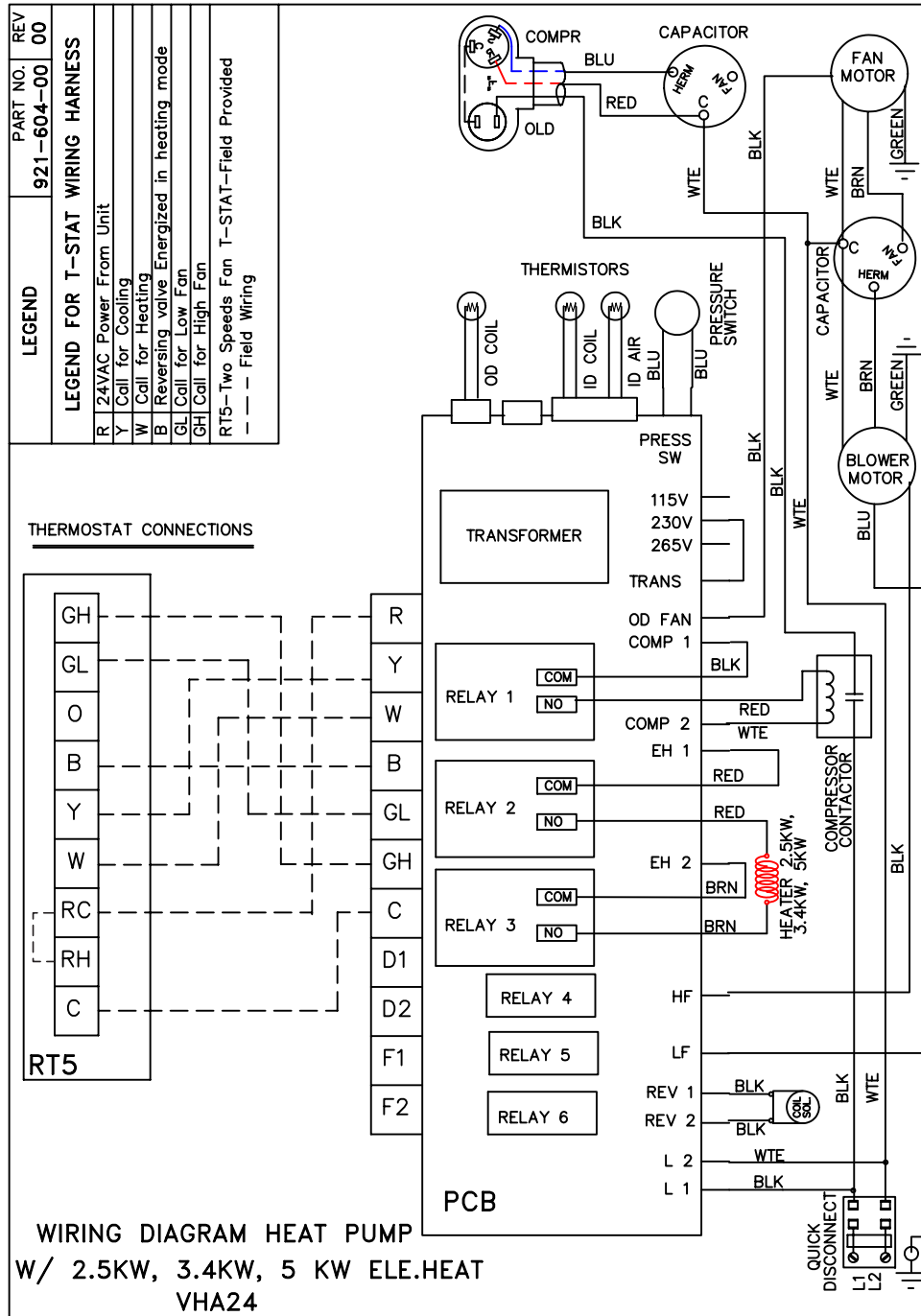

COOL WITH ELECTRIC HEAT ELECTRICAL & THERMOSTAT WIRING DIAGRAM VEA 24 with 7.5 KW and 10 KW ELECTRIC HEAT

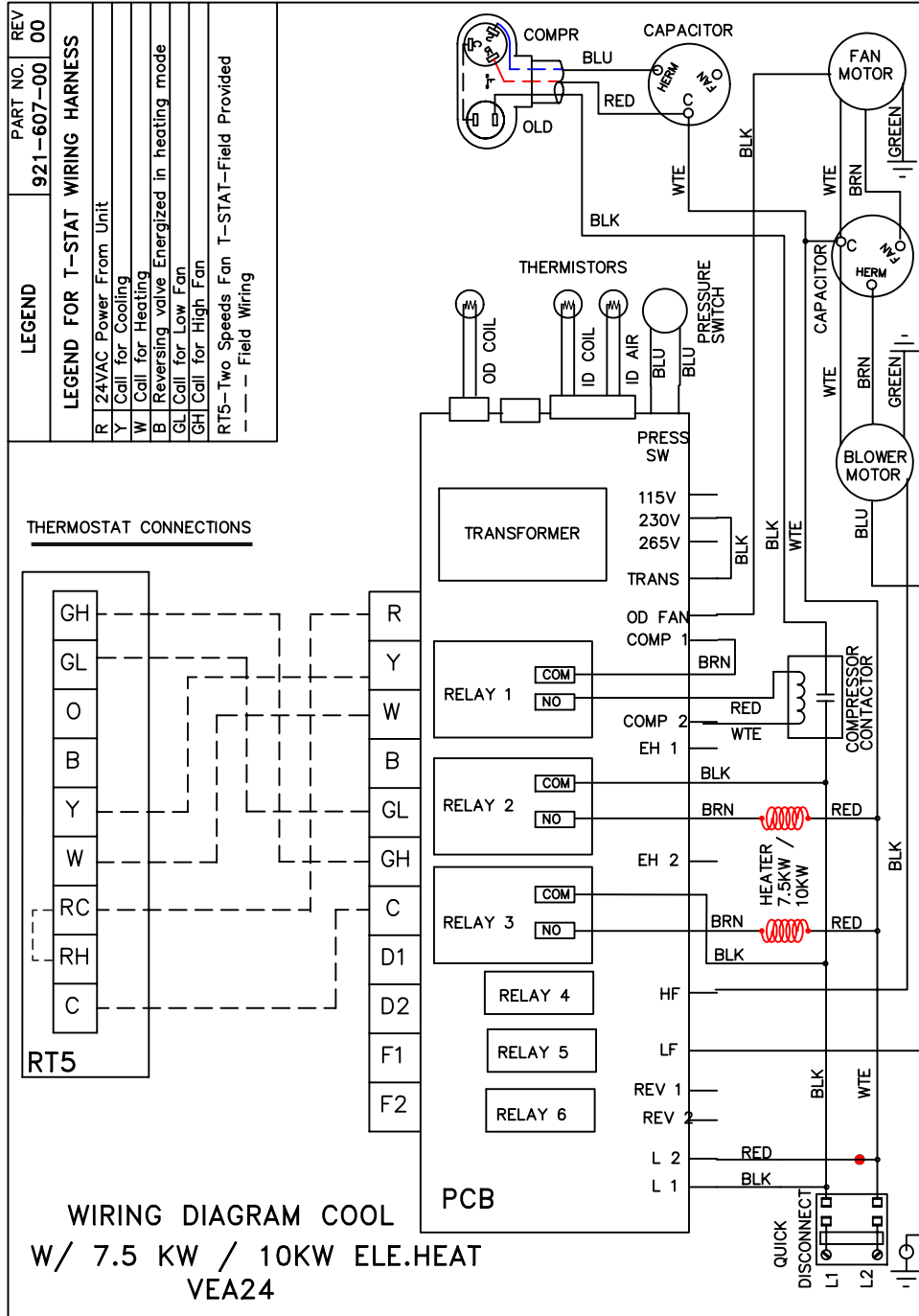

HEAT PUMP WITH ELECTRIC HEAT ELECTRICAL & THERMOSTAT WIRING DIAGRAM VHA 24 with 7.5 KW and 10KW ELECTRIC HEAT

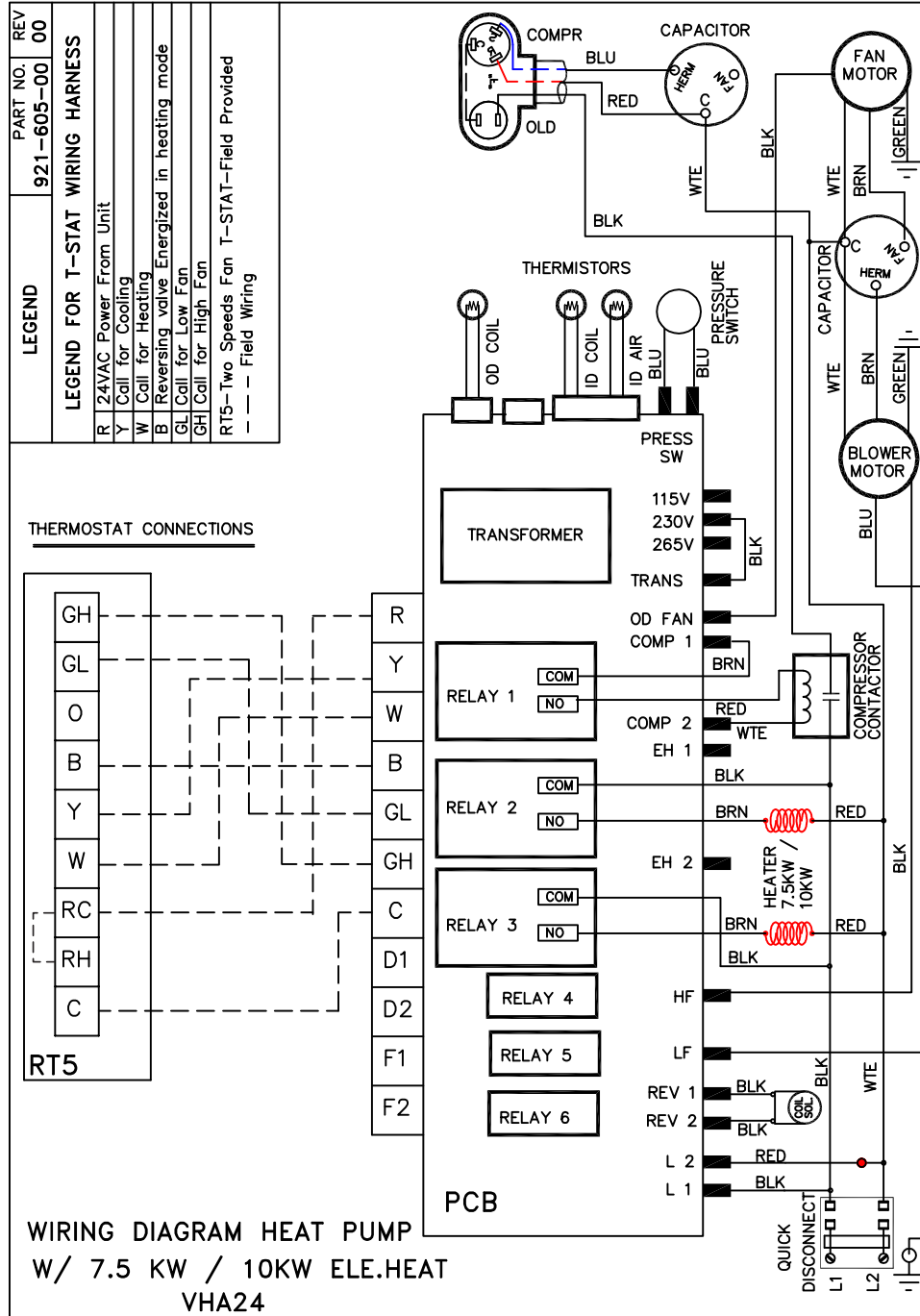

TECHNICAL SERVICE DATA

SERVICE DATA Cooling ¹	ELECTRICAL RATINGS		INDOOR COIL TEMPERATURE °F		OUTDOOR COIL TEMPERATURE °F	Discharge Line Temperature °F	Suction Line Temperature °F	Super Heat	Sub-Cooling	OPERATING PRESSURES		Refrigerant Charge
	Voltage	Amps	Supply Air	Temperature Drop Δ						Suction	Discharge	
VEA09K**RTL	230/208	4.2	58	22	118	156	66	9	24	151	389	33.5
VEA12K**RTL	230/208	5.2	57	23	116	158	59	12	17	141	396	32.0
VEA18K**RTL	230/208	8.1	55	25	127	180	60	12	28	135	455	48.0
VEA24K**RTL	230/208	10.0	55	25	125	170	61	10	34	135	440	65.0
VHA09K**RTL	230/208	4.1	57	23	117	155	62	12	20	155	405	39.0
VHA12K**RTL	230/208	5.3	55	25	119	165	65	15	23	145	450	42.0
VHA18K**RTL	230/208	8.2	51	29	129	190	60	14	35	133	465	45.0
VHA24K**RTL	230/208	10.6	51	29	128	174	60	12	32	140	480	74.0

¹Test Conditions: 80° F, Room Air Temperature with 50% Relative Humidity, and 95° F, Outdoor Air Temperature with 40% Relative Humidity

**Denotes Heater KW - Numbers Vary

TECHNICAL SUPPORT CONTACT INFORMATION



F R I E D R I C H

FRIEDRICH AIR CONDITIONING CO.

Post Office Box 1540 · San Antonio, Texas 78295-1540
4200 N. Pan Am Expressway · San Antonio, Texas 78218-5212
(210) 357-4400 · 1-800-541-6645 · FAX (210) 357-4490
www.friedrich.com

Printed in the U.S.A.



FRIEDRICH AIR CONDITIONING CO.

Post Office Box 1540 · San Antonio, Texas 78295-1540
4200 N. Pan Am Expressway · San Antonio, Texas 78218-5212
(210) 357-4400 · FAX (210) 357-4490
www.friedrich.com

Printed in the U.S.A.

VPK-ServMan-L (1-10)