

# User's Guide

for the

# CRATE PRO AUDIO

# PX700DLX/ PX900DLX



## Powered Mixer

with

## Digital Signal Processing

In order to achieve maximum performance from your new Crate Pro Audio Mixer we recommend that you read this user's guide prior to its use.

**CRATE PRO AUDIO**

# CRATE PRO AUDIO PX700DLX/PX900DLX Powered Mixer







## Congratulations.

You are now the proud owner of one of the most compact, user-friendly, and efficient powered mixers available, the Crate Pro Audio PX700DLX/PX900DLX with Digital Signal Processing. In order to derive the most benefit from the mixer, and to fully understand and appreciate its flexibility and versatility, please familiarize yourself with the mixer by reading through this User's Guide prior to its use.

And Thank You, from **CRATE PRO AUDIO**

## Table of Contents:

Features . . . . .	3
System Block Diagram . . . . .	3
The "Mono" Input Channels (1-4) . . . . .	4
The "Stereo" Input Channels (5-7/5-9) . . . . .	5
The Master Section . . . . .	6,7
The Rear Panel . . . . .	7
Technical Specifications . . . . .	.back cover

 <b>CAUTION</b> RISK OF ELECTRIC SHOCK DO NOT OPEN	 <b>PRECAUCION</b> RIESGO DE CORRIENTAZO NO ABRA	 <b>ATTENTION</b> RISQUE D'ELECTROCUTION NE PAS OUVRIR	 <b>VORSICHT</b> ELEKTRISCHE SCHLAGGEFAHR NICHT OFFENEN																								
CAUTION: TO REDUCE THE RISK OF ELECTRIC SHOCK, DO NOT REMOVE COVER. NO USER-SERVICEABLE PARTS INSIDE. REFER SERVICING TO QUALIFIED SERVICE PERSONNEL.	PRECAUCION PARA DISMINUIR EL RIESGO DE CORRIENTAZO NO ABRA LA CUBIERTA. NO HAY PIEZAS ADENTRO QUE EL USUARIO PUEDO REPARAR. DEJE TODO MANTENIMIENTO A LOS TECNICOS CALIFICADOS.	ATTENTION: POUR REDUIRE D'ELECTROCUTION NE PAS ENLEVER LE COUVERCLE. AUCUNE PIECE INTERNE N'EST REPRABLE PAR L'UTILISATEUR. POUR TOUTE REPARATION, S'ADRESSER A UN TECHNICIEN QUALIFIE.	VORSICHT: ZUR MINIMIERUNG ELEKTRISCHER SCHLAGGEFAHR NICHT DEN DECKEL ABENHMEN. INTERNE TEILE KONNEN NICHT VOM BENUTZER GEWARTET WERDEN. DIE WARTUNG IS QUALIFIZIERTEM WARTUNGSPERSONAL ZU UBERLASSEN.																								
THIS EQUIPMENT HAS BEEN DESIGNED AND ENGINEERED TO PROVIDE SAFE AND RELIABLE OPERATION. IN ORDER TO PROLONG THE LIFE OF THE UNIT AND PREVENT ACCIDENTAL DAMAGES OR INJURY, PLEASE FOLLOW THESE PRECAUTIONARY GUIDELINES:	<b>CAUTION:</b> TO REDUCE THE RISK OF ELECTRIC SHOCK, DO NOT OPEN CHASSIS; DO NOT DEFEAT OR REMOVE THE GROUND PIN OF THE POWER CORD; CONNECT ONLY TO A PROPERLY GROUNDED AC POWER OUTLET.	<b>WARNING:</b> TO REDUCE THE RISK OF FIRE OR ELECTRIC SHOCK, DO NOT EXPOSE THIS EQUIPMENT TO RAIN OR MOISTURE.  <b>CAUTION:</b> NO USER-SERVICEABLE PARTS INSIDE. REFER SERVICING TO QUALIFIED SERVICE PERSONNEL.	<b>CAUTION:</b> OUR AMPLIFIERS ARE CAPABLE OF PRODUCING HIGH SOUND PRESSURE LEVELS. CONTINUED EXPOSURE TO HIGH SOUND PRESSURE LEVELS CAN CAUSE PERMANENT HEARING IMPAIRMENT OR LOSS. USER CAUTION IS ADVISED AND EAR PROTECTION IS RECOMMENDED IF UNIT IS OPERATED AT HIGH VOLUME.																								
ESTE APARATO HA SIDO DISENADO Y CONSTRUIDO PARA PROVEER AÑOS DE OPERACION SEGURA Y CONFIABLE. PARA PROLONGAR LA VIDA DE ESTA UNIDAD E IMPEDIR DANOS ACCIDENTALES POR FAVOR SIGA ESTAS INSTRUCCIONES PREVENTIVAS:	<b>PRECAUCION:</b> PARA DISMINUIR EL RIESGO DE DESCARGAS ELECTRICAS: (1) NO ABRA LA CUBIERTA, (2) NO ES RECOMENDABLE REMOVER O DESACTIVAR LA PATA DEL POLO A TIERRA DEL CABLE DE CORRIENTE, CONECTE CORRECTAMENTE A UNA TOMA DE CORRIENTE A TIERRA.	<b>ADVERTENCIA:</b> PARA EVITAR DESCARGAS ELECTRICAS O PELIGRO DE INCENDIO, NO DEJE ESTE APARATO EXPUESTO A LA LLUVIA O HUMEDAD.  <b>PRECAUCION:</b> NO HAY PIEZAS ADENTRO QUE EL USUARIO PUEDE REPARAR. DEJE TODO MANTENIMIENTO A LOS TECNICOS CALIFICADOS.	<b>PRECAUCION:</b> NUESTROS AMPLIFICADORES PUEDEN PRODUCIR NIVELES DE PRESION DE SONIDO ALTO. EXPOSICION CONTINUADA A LOS NIVELES DE PRESION DE SONIDO ALTO PUEDE CAUSAR DANO PERMANENTE A SU OIDO. ES ACONSEJADO QUE USE PRECAUCION AL USUARIO Y ES RECOMENDADO PROTECCION PARA LOS OIDOS SI LA UNIDAD ES OPERADA A VOLUMEN ALTO.																								
THE CHART BELOW SHOWS THE U.S. GOVERNMENT'S OCCUPATIONAL SAFETY AND HEALTH ADMINISTRATION (OSHA) REGULATIONS WHICH WERE IN EFFECT AT THE TIME OF THIS PUBLICATION FOR PERMISSIBLE NOISE EXPOSURE, PER 29CFR1910.95, TABLE G-16:																											
<table border="1"> <thead> <tr> <th>SOUND LEVEL DBA, SLOW RESPONSE</th> <th>DURATION PER DAY IN HOURS</th> </tr> </thead> <tbody> <tr> <td>90</td> <td>8</td> </tr> <tr> <td>92</td> <td>6</td> </tr> <tr> <td>95</td> <td>4</td> </tr> </tbody> </table>	SOUND LEVEL DBA, SLOW RESPONSE	DURATION PER DAY IN HOURS	90	8	92	6	95	4	<table border="1"> <thead> <tr> <th>SOUND LEVEL DBA, SLOW RESPONSE</th> <th>DURATION PER DAY IN HOURS</th> </tr> </thead> <tbody> <tr> <td>97</td> <td>3</td> </tr> <tr> <td>100</td> <td>2</td> </tr> <tr> <td>102</td> <td>1 - 1/2</td> </tr> </tbody> </table>	SOUND LEVEL DBA, SLOW RESPONSE	DURATION PER DAY IN HOURS	97	3	100	2	102	1 - 1/2	<table border="1"> <thead> <tr> <th>SOUND LEVEL DBA, SLOW RESPONSE</th> <th>DURATION PER DAY IN HOURS</th> </tr> </thead> <tbody> <tr> <td>105</td> <td>1</td> </tr> <tr> <td>110</td> <td>1/2</td> </tr> <tr> <td>115</td> <td>1/4 or less</td> </tr> </tbody> </table>	SOUND LEVEL DBA, SLOW RESPONSE	DURATION PER DAY IN HOURS	105	1	110	1/2	115	1/4 or less	
SOUND LEVEL DBA, SLOW RESPONSE	DURATION PER DAY IN HOURS																										
90	8																										
92	6																										
95	4																										
SOUND LEVEL DBA, SLOW RESPONSE	DURATION PER DAY IN HOURS																										
97	3																										
100	2																										
102	1 - 1/2																										
SOUND LEVEL DBA, SLOW RESPONSE	DURATION PER DAY IN HOURS																										
105	1																										
110	1/2																										
115	1/4 or less																										
ACCORDING TO OSHA, ANY EXPOSURE IN EXCESS TO THESE AMOUNTS LISTED ABOVE COULD RESULT IN SOME HEARING LOSS.																											
EXPLANATION OF GRAPHICAL SYMBOLS: EXPLICACION DE SIMBOLOS GRAFICOS:	 = "DANGEROUS VOLTAGE" / "VOLTAJE PELIGROSO" / "DANGER HAUTE TENSION" / "GEFAHRICHE SPANNUNG"	 = "IT IS NECESSARY FOR THE USER TO REFER TO THE INSTRUCTION MANUAL" / "ES NECESARIO QUE EL USUARIO SE REFIERA AL MANUAL DE INSTRUCCIONES" / "REFERREZ-VOUS AU MANUAL D'UTILISATION" / "UNBEDINGT IN DER BETRIEBUNGSANLEITUNG NACHSCHLAGEN"																									

# CRAVE AUDIO PX700DLX/PX900DLX Powered Mixer

## Features:

### The Input Channels:

- Peak/Signal LEDs for optimum level settings
- Three bands of equalization
- Monitor, effects, and main level controls
- Gain control
- Pad switch (channels 1-4 only) to accommodate "hot" signals
- 1/4" balanced low impedance and XLR balanced high impedance input jacks
- Color coded knobs for ease of reference

### The Master Section:

- Separate 7-band graphic eq's for Monitor/Main 2 and Main/Main 1 (switchable)
- Separate Master level controls for Monitor/Main 2 and Main/Main 1 (switchable)
- Built in Limiter to prevent overdriving the amplifiers
- Five-segment LED displays for monitoring the output signals
- Effects send and return controls
- Switchable phantom power
- DSP Digital Signal Processing with on/off switch and four selectable effects
- Footswitch jack for remote control of DSP on/off
- Effects send/aux in jacks for external effects
- Tape in and tape out jacks for recording and play back
- Main and monitor line out jacks
- Color coded knobs for ease of reference

## System Block Diagram:

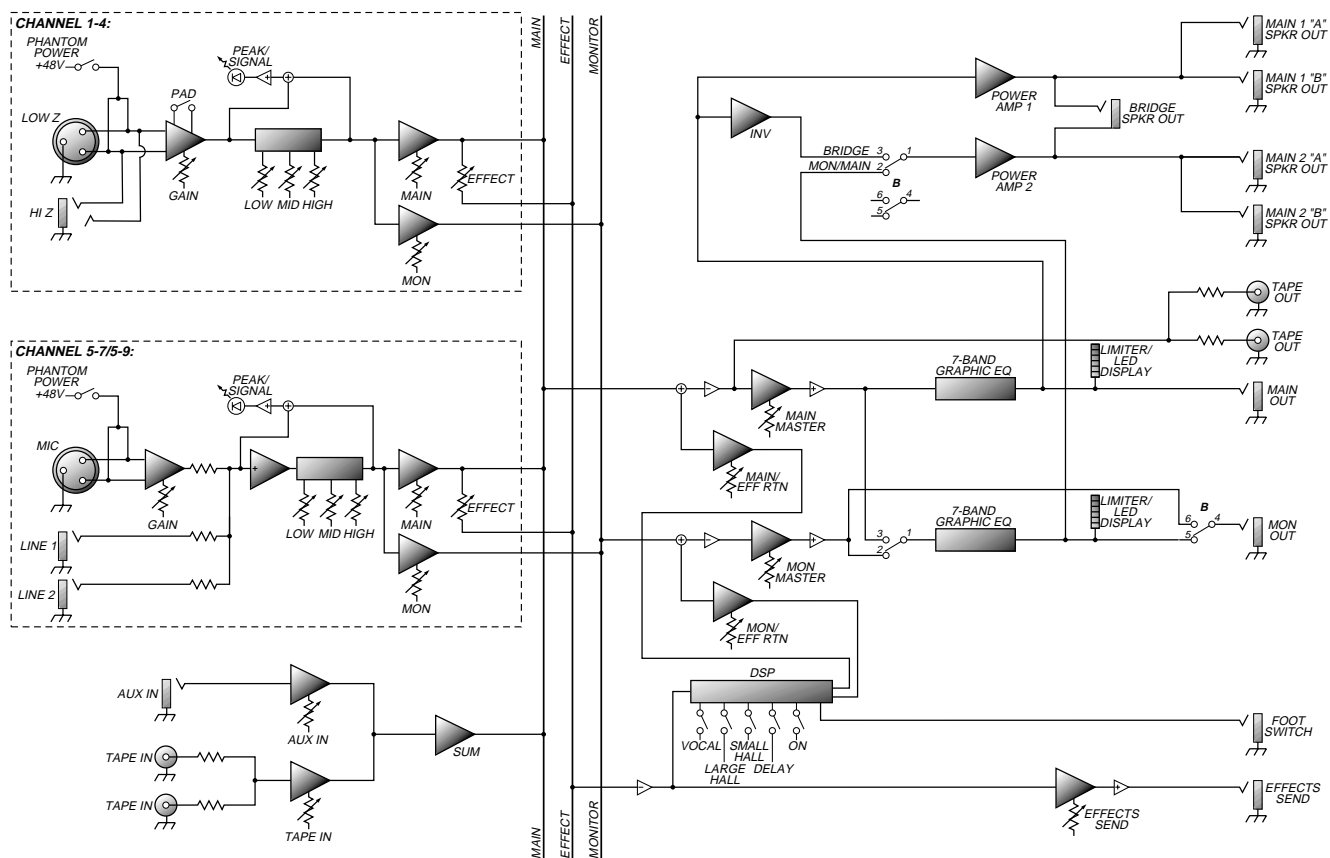

# CRATE PRO AUDIO PX700DLX/PX900DLX Powered Mixer

## The “Mono” Input Channels (1-4):

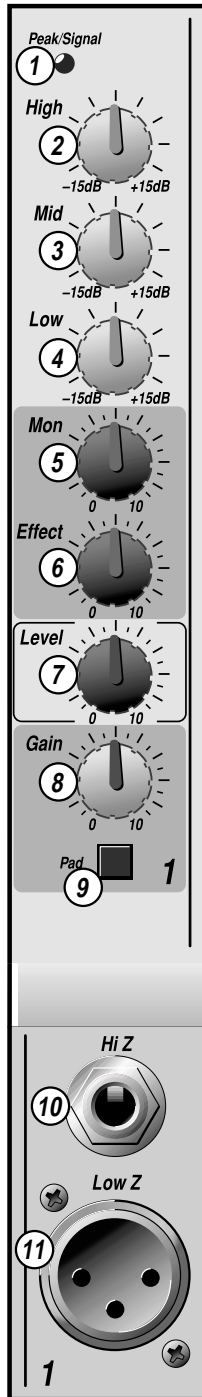

1. **PEAK/SIGNAL LED:** This LED will illuminate green when a signal is present at the High or Low Z inputs. When the signal nears clipping, the LED will illuminate red. (See Gain control, #8.)
2. **HIGH:** Use this control to adjust the high frequency level for the channel. This control allows for 15dB of cut or boost at 12kHz.
3. **MID:** Use this control to adjust the midrange frequency level for the channel. This control allows for 15dB of cut or boost at 2.5kHz.
4. **LOW:** Use this control to adjust the low frequency level for the channel. This control allows for 15dB of cut or boost at 80Hz.
5. **MON:** Use this control to set the amount of the channel's signal sent to the monitors.
6. **EFFECT:** Use this control to set the amount of internal DSP effect (or external effects, if used) to be applied to the channel.
7. **LEVEL:** Use this control to set the channel's output signal level.
8. **GAIN:** Use this control to set the input signal level for the channel. Adjust this control so the peak/signal LED (#1) flashes red on strong signal peaks.
9. **PAD:** Use this switch to accommodate “hot” input signals. (Signals too strong to allow a useful setting of the gain control without causing the peak/signal LED to glow red.) Depress this switch to engage the 20dB pad, thereby reducing the input signal's level to a more useable range.
10. **HIGH Z INPUT:** The signal output from a high impedance microphone or a line level signal (such as an instrument, rhythm machine, tape deck, etc.) may be connected here by means of a shielded cable terminated with a male 1/4” plug. Tip = “+,” ring = “-,” and sleeve = shield.
11. **LOW Z INPUT:** The signal output from a low impedance microphone or a low impedance line level signal (such as a line out signal from an instrument amplifier) may be connected here by means of a shielded cable terminated with a male XLR plug. Pin 2 = “+,” pin 3 = “-,” and pin 1 = shield.

# CRATE PRO AUDIO PX700DLX/PX900DLX Powered Mixer

## The “Stereo” Input Channels (5-7/5-9):

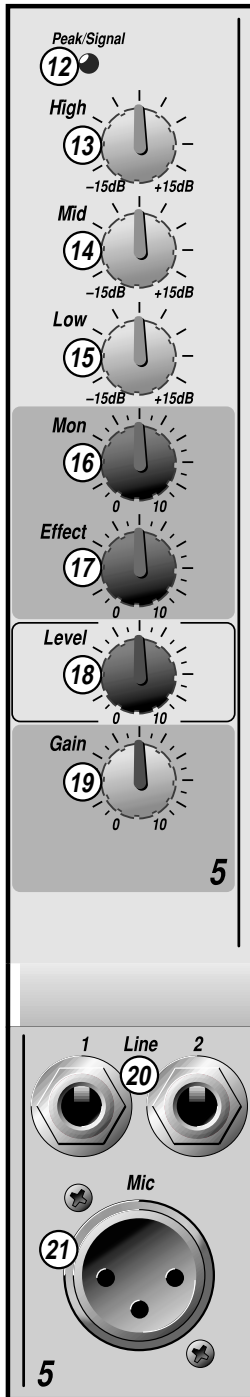

12. **PEAK/SIGNAL LED:** This LED will illuminate green when a signal is present at the High or Low Z inputs. When the signal nears clipping, the LED will illuminate red. (See Gain control, #19.)
13. **HIGH:** Use this control to adjust the high frequency level for the channel. This control allows for 15dB of cut or boost at 12kHz.
14. **MID:** Use this control to adjust the midrange frequency level for the channel. This control allows for 15dB of cut or boost at 2.5kHz.
15. **LOW:** Use this control to adjust the low frequency level for the channel. This control allows for 15dB of cut or boost at 80Hz.
16. **MON:** Use this control to set the amount of the channel's signal sent to the monitors.
17. **EFFECT:** Use this control to set the amount of internal DSP effect (or external effects, if used) to be applied to the channel.
18. **LEVEL:** Use this control to set the channel's output signal level.
19. **GAIN:** Use this control to set the input signal level for the channel. Adjust this control so the peak/signal LED (#12) flashes red on strong signal peaks.
20. **LINE 1/LINE 2 INPUTS:** The signal output from a stereo source (such as a stereo instrument, rhythm machine, tape deck, etc.) may be connected here by means of a pair of shielded cables, each terminated with a male 1/4" plug. Tip = "+," ring = "-", and sleeve = shield. The left and right signals are summed internally to become a mono signal – without the need for external summing devices or adapter cables.
21. **MIC INPUT:** The signal output from a low impedance microphone or a low impedance line level signal (such as a line out signal from an instrument amplifier) may be connected here by means of a shielded cable terminated with a male XLR plug. Pin 2 = "+," pin 3 = "-", and pin 1 = shield.

# CRATE AUDIO PX700DLX/PX900DLX Powered Mixer

## The Master Section:

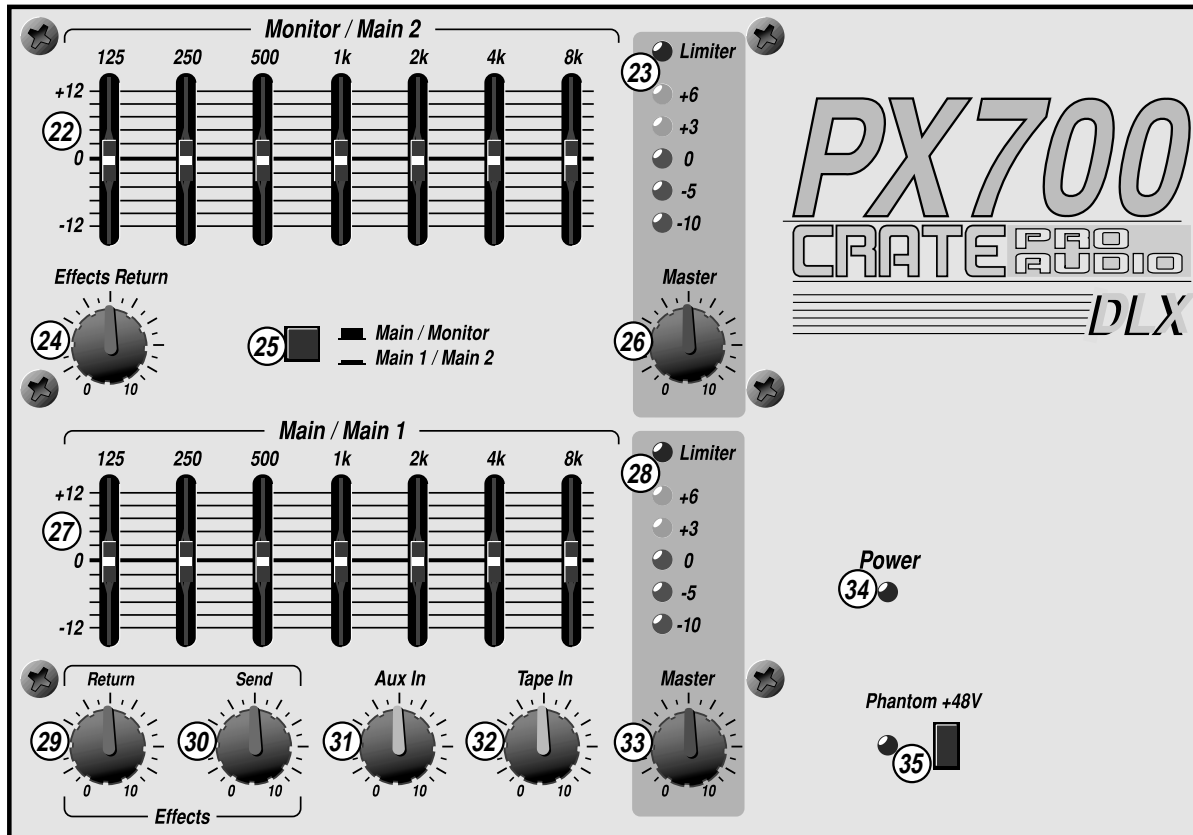

**22,27. GRAPHIC EQ'S:** These seven band graphic equalizers allow customization and shaping of the output signals to match room acoustics and enhance the sound. Use the selector switch (#25) to determine where the equalization will be applied: either to the main and monitor output signals, or to the main 1 and main 2 output signals.

**23,28. LED METERS/LIMITER INDICATORS:** These LED meters monitor the output signal levels for either the main and monitor output signals, or the main 1 and main 2 output signals (dependent on the setting of the selector switch, #25). The red LED's illuminate when the internal limiter is engaged to prevent the signal from being clipped. (Clipping results in overdrive distortion and should be avoided.) If the limiter LED's flash continuously or remain on constantly during use, reduce the output signal levels until they flash only on strong signal peaks.

**24,29. EFFECTS RETURNS:** Use these controls to adjust the magnitude of the effects applied to the output signals. Use the selector switch (#25) to determine where the effects will be applied: either to the main and monitor output signals, or to the main 1 and main 2 output signals.

**25. MAIN/MONITOR / MAIN1/MAIN 2:** Use this switch to select whether the graphic EQ's, LED meters, and master level controls are assigned to the Main and Monitor outputs (switch in the out position) or to the Main 1 and Main 2 outputs (switch depressed. When this switch is in the out position, the Main/Main 1 graphic EQ (#27) controls the signal to power amp #1, the output of which

is connected to the Main Output jack (#44). Also, the Monitor/Main 2 graphic EQ (#22) controls the signal to power amp #2, the output of which is connected to the Monitor Output jack (#43).

When this switch is depressed, the Main/Main 1 graphic EQ (#27) controls the signal to power amp #1, the output of which is connected to the Main 1 Speaker Output jacks (#46). Also, the Monitor/Main 2 graphic EQ (#22) controls the signal to power amp #2, the output of which is connected to the Main 2 Speaker Output jacks (#46).

**30. EFFECTS SEND:** Use this control to set the overall signal level sent to the internal DSP or external effects (if used).

**31. AUX IN:** Use this control to set the input signal level of the aux in jack (#40).

**32. TAPE IN:** Use this control to set the input signal level of the tape in jacks (#41).

**34. POWER LED:** This LED illuminates when the mixer is on.

**35. PHANTOM +48V:** This switch, when depressed, applies +48 volts DC to pins 2 and 3 of each channel's XLR input jacks. This allows use of microphones which require a source of phantom power for proper operation. (Mics not requiring phantom power will not be affected by the presence of the DC voltage.) The adjacent LED illuminates when the phantom power is on.

(continued...————>)

# CRATE PRO AUDIO PX700DLX/PX900DLX Powered Mixer

## The Master Section (continued):

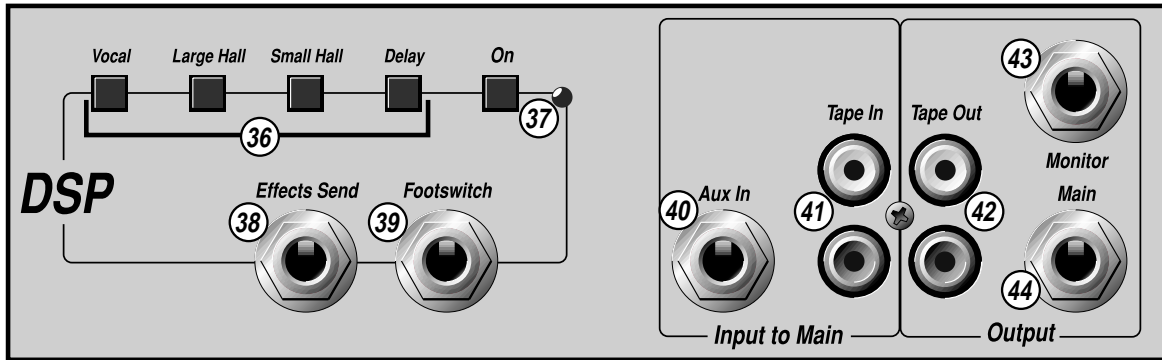

- 36. DSP SELECTORS:** Use these switches to select the type of digital signal processing effect to be applied – vocal, large hall, and small hall are reverberation effects; delay is a digital delay effect.
- 37. DSP ON:** Use this switch to activate the internal digital signal processor. When this switch is depressed, the selected DSP effect is activated.
- 38. EFFECTS SEND:** Use this jack to send a signal to an external effects device. The signal level at this jack is set by the effects send control (#30).
- 39. FOOTSWITCH:** Use this jack to connect a footswitch for remote on/off control of the DSP and external effects device. The footswitch must be a normally open, momentary type such as the Crate model #FSIU. The wiring for the footswitch is as shown:

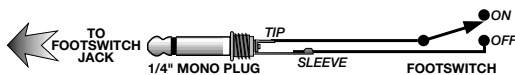

- 40. AUX IN:** Use this jack as the return jack when using an external effects device, or to feed another mixer's signal into the PX700DLX/PX900DLX. This jack is post-input channel, pre-eq, and pre-power amp.
- 41. TAPE IN:** Use these jacks to connect the outputs of a tape deck or CD player to the mixer. The playback signal level is set by the tape in level control (#32).
- 42. TAPE OUT:** Use these jacks to connect the mixer to a tape recorder. These jacks are post-eq, pre-master, and their signal level is determined by the channel level controls.
- 43. MONITOR OUT:** Use this jack to send a line level, monitor mix signal to the power amplifier you are using for your monitor speakers.
- 44. MAIN OUT:** Use this jack to send a line level, main mix signal to an external power amplifier (if used), a recording console, or to the aux in jack of another PX700DLX/PX900DLX.

## The Rear Panel:

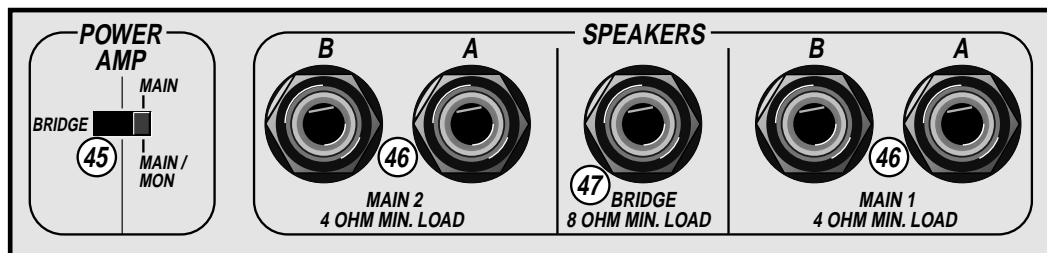

- 45. POWER AMP SWITCH:** Use this switch to set the amplifier for mono bridged operation (switch to the left) or for main/monitor operation (switch to the right).
- 46. MAIN 1/MAIN 2 SPEAKERS:** Use these jacks to connect the mixer to your PA speakers, **only** when the power amp switch (#45) is set to the main/monitor position. Observe the 4 ohm minimum load rating and all other speaker information printed on the rear of the mixer.
- 47. BRIDGE SPEAKER:** Use this jack to connect the mixer to your PA speakers, **only** when the power amp switch (#45) is set to

the bridge position. Observe the 8 ohm minimum load rating and all other speaker information printed on the rear of the mixer.

- 48. AC LINE CORD (not shown):** Connect this cord to a suitable source of AC power, as indicated to the right of the cable. **DO NOT ATTEMPT TO BYPASS THE GROUND CONNECTION OF THIS POWER CABLE!**
- 49. POWER SWITCH (not shown):** Use this switch to apply AC voltage to the mixer. The mixer is on when the switch is depressed, off when the switch is in the out position.

# CRATE PRO AUDIO PX700DLX/PX900DLX Powered Mixer

## Technical Specifications

<b>MAXIMUM VOLTAGE GAIN (PAD OFF)</b>	86dB Ch In (Lo-Z) to Power Amp Out (Ch 1-4) 66dB Ch In (Lo-Z) to Main Out, Monitor Out (Ch 1-4) 72dB Ch In (Lo-Z) to Effect Out (Ch 1-4) 50dB Ch In (Lo-Z) to Rec Out (Ch 1-4) 54dB Ch In (Hi-Z) to Main Out, Monitor Out (Ch 1-4) 25dB Aux In to Main Out 73dB Mic In to Main Out, Monitor Out (Ch 5-7/5-9) 28dB Line In to Main Out, Monitor Out (Ch 5-7/5-9)
<b>INPUT CHANNEL EQUALIZATION</b>	±15dB Maximum High: 12kHz (shelving); Mid: 2.5kHz (peaking); Low: 80Hz (shelving)
<b>FREQUENCY RESPONSE</b>	+1/-3dB, 20Hz-20kHz @ 1W output into 8Ω (Power Amp Out) +1/-3dB, 20Hz-20kHz @ +4dB output into 10kΩ (Main Out, Monitor Out, Effects Send)
<b>MAXIMUM OUTPUT POWER</b>	200W/4Ω @ 0.5% THD @ 1kHz
<b>TOTAL HARMONIC DISTORTION</b>	<0.3% @ 20Hz-20kHz, 100W output into 4Ω (Power Amp Out) <0.3% @ 20Hz-20kHz, +14dB output into 10kΩ (Main Out, Monitor Out, Effects Send)
<b>HUM AND NOISE (Average, Rs=150Ω) (with 20Hz-20kHz BPF)</b>	-122dB equivalent input noise, -63dB residual output noise (Power Amp Out) -78dB residual output noise (Main Out, Monitor Out, Effects Send) -73dB (77dB S/N) (Main Out, Monitor Out) All channel level controls at minimum -40dB (44dB S/N) (Main Out, Monitor Out) One channel level controls at maximum -74dB (78dB S/N) Effects Send All channel level controls at minimum -34dB (38dB S/N) Effects Send One channel level controls at maximum
<b>CROSSTALK @ 1kHz</b>	63dB adjacent input, 63dB input to output
<b>GRAPHIC EQUALIZER</b>	7 bands (125Hz, 250Hz, 500Hz, 1kHz, 2kHz, 4kHz, 8kHz) ±12dB Maximum
<b>INTERNAL DIGITAL EFFECT</b>	4 types (Digital Delay, Vocal, Large Hall, Small Hall)
<b>PHANTOM POWER</b>	+48V is supplied to electrically balanced inputs for powering condenser microphones via 6.8kΩ current limiting/isolating resistors
<b>LIMITER LED ON</b>	Output Level: 36dB
<b>FOOT SWITCH</b>	DSP Mute: on/off
<b>POWER CONSUMPTION</b>	200W
<b>SIZE AND WEIGHT</b>	<b>PX700DLX:</b> 18.9" (480mm) W x 10.8" (275mm) H x 10.8" (275mm) D; 37.5 lbs (17kg) <b>PX900DLX:</b> 21.6" (546mm) W x 10.8" (275mm) H x 10.8" (275mm) D; 39 lbs (17.7kg)

*Due to ongoing product development and improvement, the specifications contained herein are subject to change without notice.*



[www.crateproaudio.com](http://www.crateproaudio.com)

©2000 SLM Electronics, Inc. • A Division of St. Louis Music, Inc.  
1400 Ferguson Avenue • St. Louis, MO 63133

18-029-01 • 01/00

