

Haier

LCD TV RECEIVER

USER'S MANUAL

Please read this manual carefully before using your television and keep this manual in a good place for future reference.

MODEL:

L1510A-C, L15C10A, L1920A-C,
L1910A-C, L19C10A, L1510B-C,
L15C10B, L1910B-C, L19C10B,
L1911W-C, L19C11W, L2011W-C,
L20C11W, L1912W-C, L19C12W,
L2012W-C, L20C12W

To users:

Thank you for using our LCD-TV.

Before connecting the LCD-TV and turning the power on, please read this book carefully. Please keep this book for later use. When it was loss of function by electrostatic shock, please switch the on/off button for restoring the function.

CONTENT

Safety Notice Items.....	1
Front Panel Controls.....	2
Connection Options.....	3
Remote Control Key Functions.....	4
Remote Control	5
Installing Batteries.....	5
Connection Instructions.....	6
Grounding.....	6
External equipment Connections.....	6
Antenna Connection.....	6
VGA Input.....	7
YPbPr Input.....	7
S-VIDEO Input.....	8
SCART Input.....	9
HDMI Input.....	9
Basic Operating Instructions.....	10
Turn on the LCD-TV.....	10
Audio Control.....	10
Mute.....	10
Select the TV Channel You Want.....	11
Picture Mode.....	11
Program Swap.....	11
Program Scan.....	11
Menu Operations.....	12
Picture Menu Options.....	12
Picture Menu Options Continued.....	13
Audio Menu Options.....	13
Audio Menu Options Continued.....	14
Function Menu Options.....	15
Function Menu Options Continued.....	16
Adjust Menu Options.....	17
Tuning Menu Options.....	18
Tuning Menu Options Continued.....	19
TELE TEXT.....	20
Basic Playback.....	22
Advanced Playback.....	23
Special Function Playback.....	24
JPEG DISC PLAYBACK.....	24
SCREEN SAVER FUNCTION.....	24
DVD System SETUP.....	25
General Setup Process.....	25
General Setup Page.....	25
Preferencel Page.....	27
Playable Discs.....	29
Disc Protection and DVD Characteristics.....	30
Troubleshooting Guide.....	31
Specifications.....	32

Safety Notice Items

Incorrect usage will cause fire or electric shock. To prevent this, please do as required when you are installing, using and cleaning this machine. To insure your safety and extend the life-span of LCD-TV, please read the following items carefully before using:

- Please read and understand all the instructions before operation;
- Please keep the book for later use;
- Please comply with the warning instructions on the machine and in this book strictly;
- Please comply with the instructions provided;
- Please do not use additional devices that are not recommended by manufacturer;
- Before operation, please make sure that the operating voltage of your unit is normal;
- Do not place the unit on unstable, dusty and humid places;
- Never put the unit in direct sunlight or near heat sources;
- Allow enough space for proper ventilation;
- Please keep water away from the LCD-TV . If water comes in contact with the LCD-TV, disconnect the power cord from the power source, then wipe the set with a dry soft cloth;
- Do not remove the back cover. If services were need, please refer to qualified Personnel

Front Panel Controls

L1510A-C, L15C10A, L1920A-C,
L1910A-C, L19C10A

L1510B-C,
L15C10B, L1910B-C, L19C10B,

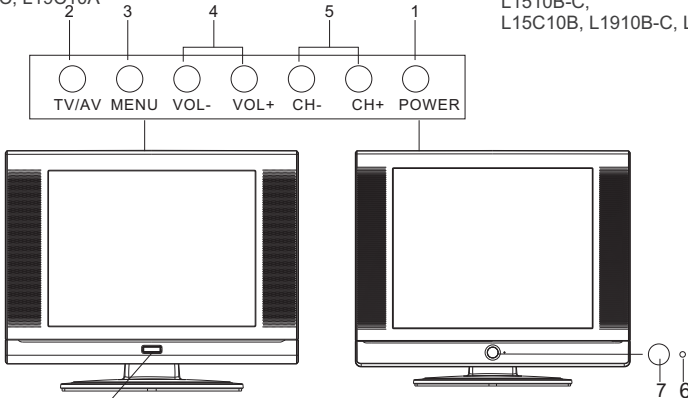

L1912W-C, L19C12W,
L2012W-C, L20C12W

L1911W-C, L19C11W,
L2011W-C, L20C11W

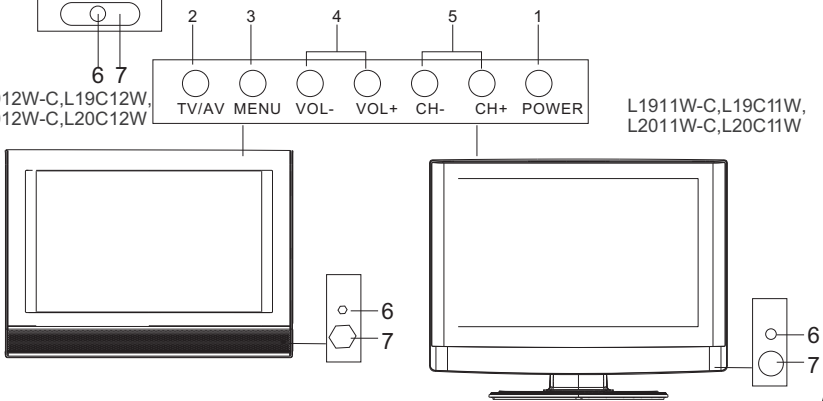

Control Panel Function

1. Power supply switch
2. TV/AV Select the input signals: PC/COMPONENT/DVD/HDMI/TV/SCART/SVIDEO
3. MENU Press to select the main menu
4. VOL- Volume down / Left orientation to adjust the item in the OSD
VOL+ Volume up / Right orientation to adjust the item/Press to enter
5. CH- TV channel down / to select the item in the menu
CH+ TV channel up / to select the item in the menu
6. Power indicator
Illuminates red in standby mode, illuminates green when the display is turned on
7. Remote Sensor Receiving remote control sends the infrared remote signal.

Connection Options

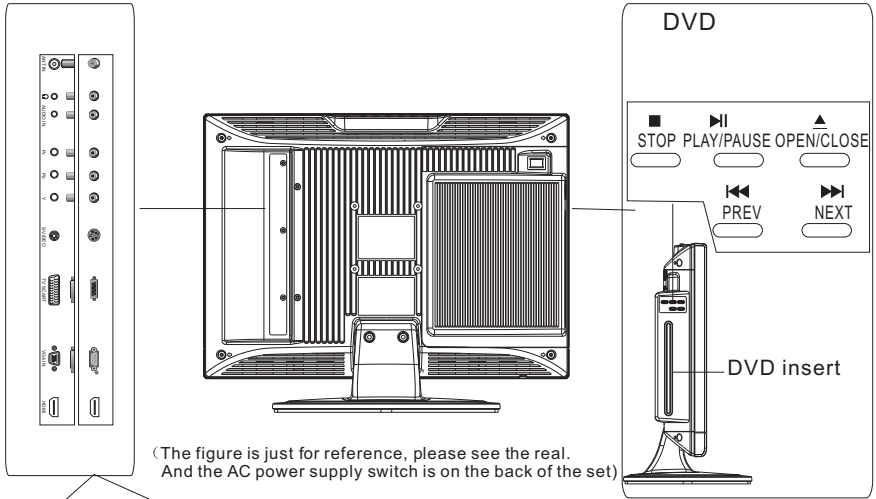

COMPONENT Input

Connect a component video/audio device to these jacks

VGA /COMPONENT/ SVIDEO Audio Input

Connect the PC output connector from a PC to the audio input port

SCART

Connect to the DVD/VCR/broadcasting receiver or other equipment

HDMI

Connect to HDMI output of other equipment

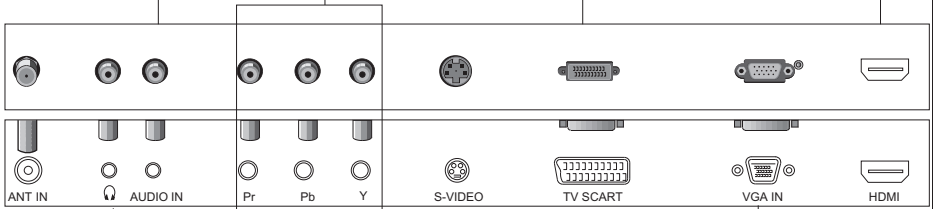

Earphone port

Antenna Input

Connect cable or antenna signals to the TV, either directly or through your cable box.

S-Video Input

Connect S-Video out from an S-Video device to the jacks.

VGA Input

Connect to the VGA 15PIN analog output connector of the PC display card for PC display purpose

Remote Control Key Functions

When using the remote control, aim it towards the remote sensor on the TV

Buttons on the remote control

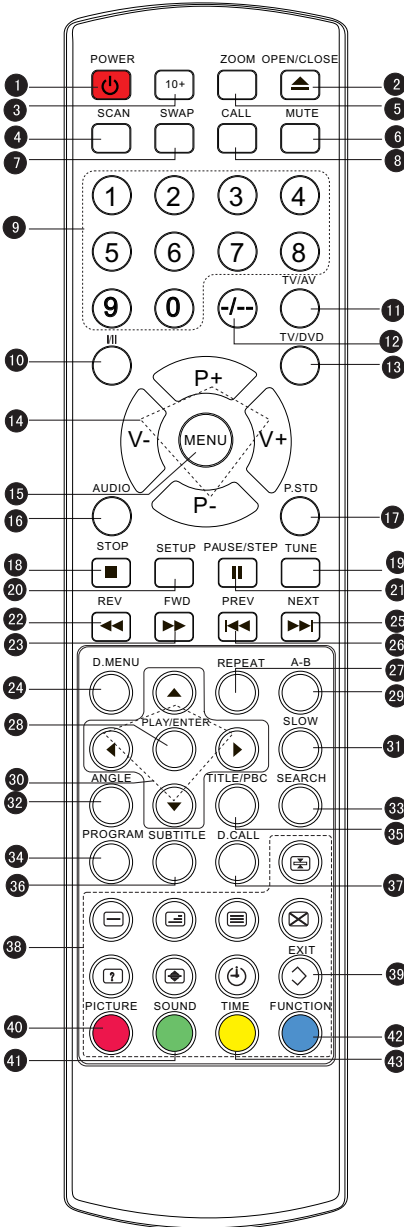

- 1 Stand By
- 2 DVD Open/close
- 3 DVD 10+
- 4 Scan
- 5 Zoom
- 6 Mute
- 7 Swap
- 8 Call Screen Display
- 9 Program Number
- 10 III
- 11 TV/AV and some other source Exchange
- 12 Digital Selector
- 13 TV/DVD
- 14 Volume/Channel Selection
- 15 MENU
- 16 DVD Audio
- 17 Picture Mode
- 18 DVD STOP
- 19 Tune Menu Button
- 20 DVD SETUP
- 21 DVD PAUSE/STEP
- 22 DVD FAST REVERSE
- 23 DVD FAST FORWARD
- 24 DVD MENU
- 25 DVD NEXT
- 26 DVD PREVIOUS
- 27 DVD REPEAT
- 28 DVD PLAY/ENTER
- 29 DVD A-B REPEAT
- 30 DVD Cursor Move button
- 31 DVD SLOW
- 32 DVD ANGLE
- 33 DVD SEARCH
- 34 DVD PROGRAM
- 35 DVD TITLE/PBC
- 36 DVD SUBTITLE
- 37 DVD CALL
- 38 TELETEXT BUTTONS
- 39 Exit Screen Display
- 40-43 Fast text coloured buttons

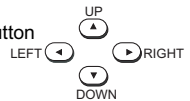

Remote Control Key Functions

Installing Batteries

1. Slide open the cover of the battery compartment on the back of the remote control.
2. Load two AA alkaline batteries in the compartment. (plus and minus poles to respective mark)
3. Replace the cover of the battery compartment.

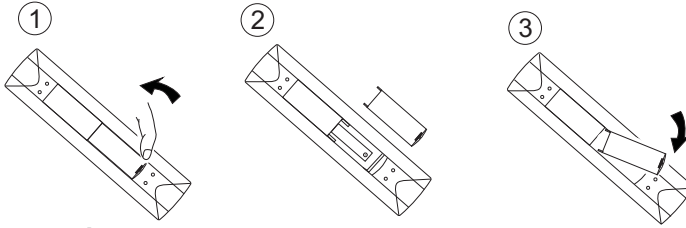

Precautions

Make sure that there is no obstacle between the remote controller and television set.

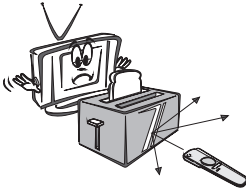

Keep the remote controller away from heat source or humid area to ensure effective performance of the remote controller.

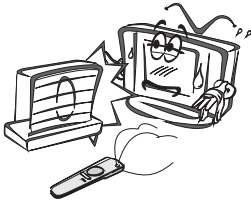

As strong light may interfere the signals, change your position to operate the remote controller if the television cannot be turned on or off as you expect.



Make sure that two AA 1.5V alkaline batteries are loaded. The batteries must be of the same type. The batteries must be located properly. The batteries are not rechargeable.

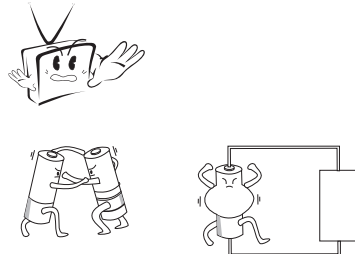

Connection Instructions

Grounding

Ensure that you connect the grounding / earth wire to prevent possible electric shock. If grounding methods are not possible, have a qualified electrician install a separate circuit breaker. Do not try to ground the unit by connecting it to telephone wires, lightning rods, or gas pipes.

External Equipment Connections

Antenna Connection

- Antenna or Cable Service with a Cable Box Connections
- For optimum picture quality, adjust antenna direction if needed.

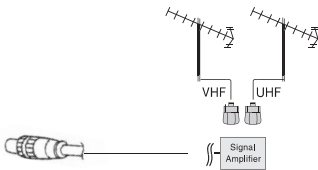
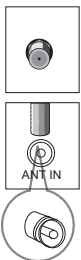
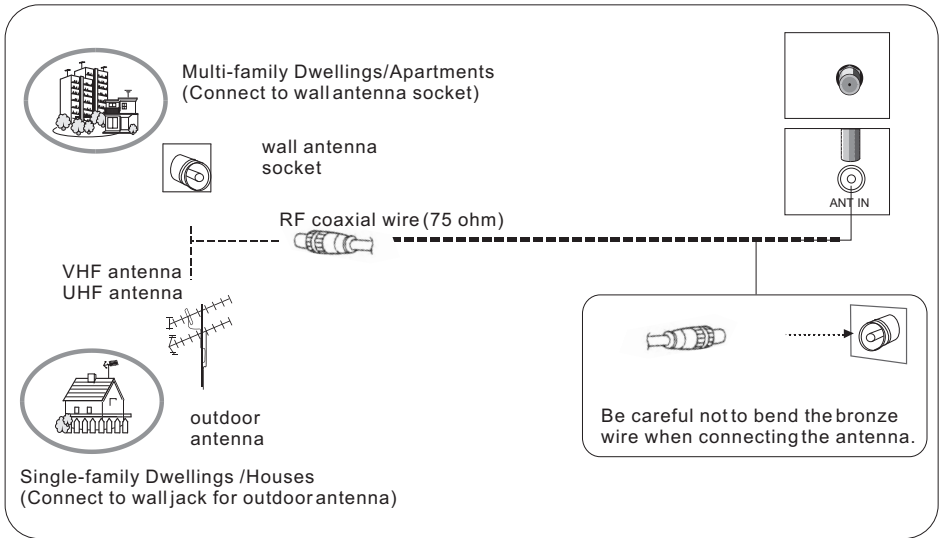

- To improve picture quality in a poor signal area, purchase and install a signal amplifier.
- If the antenna needs to be split for two TV' s, install a "2-Way Signal Splitter" in the connections.
- If the antenna is not installed properly, contact your dealer for assistance.

NOTE: All cables shown are just for example.

Connection Instructions

VGA Input

You can use your LCD-TV as a monitor for your personal computer using a VGA cable (not supplied).

Connection and use steps:

1. Read the user guide supplied with your computer and ensure that it has a VGA connector;
2. Make sure that the power of the LCD-TV and the PC are off;
3. Connect a Dtype 15-pin VGA interface cable (not supplied) to the VGA video interface connector on the PC. Then connect the other end to the PC video interface connector on the back of the LCD-TV. Tighten the screws on the VGA connectors once they are firmly connected;
4. Turn on the power of the LCD-TV first, and then turn on the power of the PC;
5. Press the TV/AV button to set the video input mode of the LCD-TV to PC-RGB;
6. Check the image on your TV. There may be noise associated with the resolution, vertical pattern, contrast or brightness in PC mode. If noise is present, change the PC mode to another resolution, change the refresh rate to another rate or adjust the brightness and contrast on the menu until the picture is clear. If the refresh rate of the PC graphic card can not be changed, change the PC graphic card or consult the manufacturer of the PC graphic card.

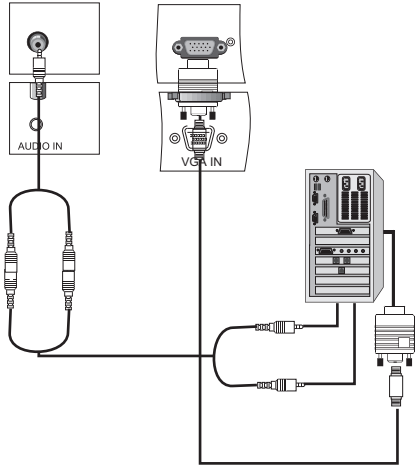

Resolution

Mode	Resolution	Line frequency (Khz)	Frame frequency (Hz)
VGA	640*480	31.5KHz	60Hz
SVGA	800*600	37.9KHz	60Hz
XGA	1024*768	48.4KHz	60Hz

Note: All above listed are subject to VESA Criteria.

YPbPr Input

How to connect

Connect the DVD video outputs (Y, PB, PR) to the COMPONENT (Y, Pb, Pr) IN jacks on the TV and connect the DVD audio outputs to the AUDIO IN jacks on the TV, as shown in the figure.

NOTE: If your DVD player does not have component video output, use S-Video.

How to use

1. Turn on the DVD player, insert a DVD.
2. Use the TV/AV button on the remote control to select

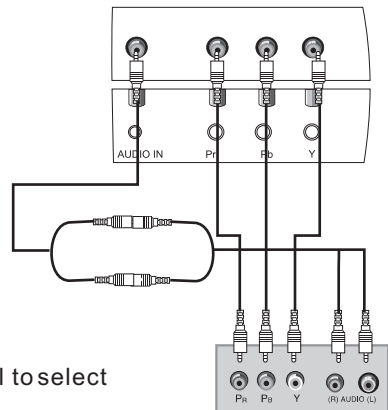

Connection Instructions

COMPONENT (If connected to SVIDEO, select the SV external input source.)

3. Refer to the DVD player's manual for operating instructions.

Component Input ports

To get better picture quality, connect a DVD player to the component input ports as shown below.

Component ports on the TV	Y	P _B	P _R
---------------------------	---	----------------	----------------

Video output ports on DVD player	Y	P _b	P _r
	Y	B-Y	R-Y
	Y	Cb	Cr
	Y	P _B	P _R

S-VIDEO Input

- To avoid picture noise (interference), leave an adequate distance between the VCR and TV

Connection and use steps:

1. Read the user guide supplied with your AV devices and ensure that it has S-Video connectors;
2. Make sure that the power of the LCD-TV and the AV device are off;

Connection Option 1

Set VCR output switch to 3 or 4 and then tune TV to the same channel number.

Connection Option 2

1. Connect the audio and Svideo cables from the VCR's output jacks to the TV input jacks, as shown in the figure.
2. Insert a video tape into the VCR and press PLAY on the VCR. (Refer to the VCR owner's manual.)
3. Turn on the power of the LCD-TV first; and then turn on the power of the AV device;
4. Press the TV/AV button to set the video input mode of the LCD-TV to SVIDEO mode.

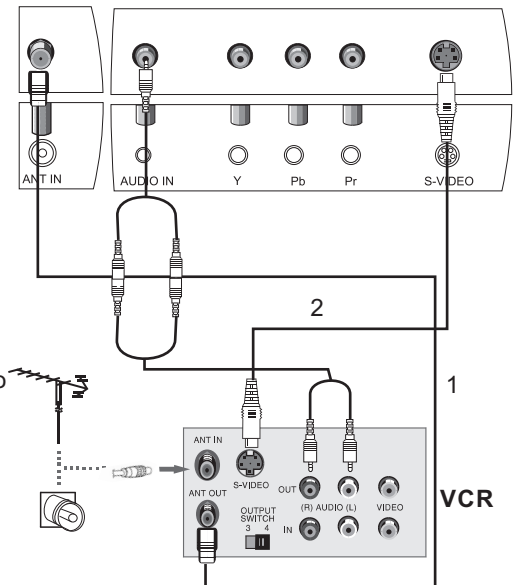

Connection Instructions

SCART Input

1. Link the scart terminal of some other equipment, such as DVD, to the TV SCART input terminal of the television.
2. Press TV/AV to select SCART mode.
3. Press Play button on external equipment for program play.

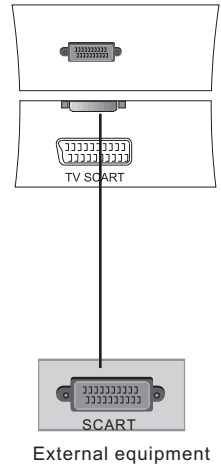

External equipment

HDMI Input

How to connect

Connect the cables from the external equipment's output jacks to the TV input jacks, as shown in the figure.

How to use

1. Select the input source by using the **TV/AV** button on the remote control.
2. Operate the corresponding external equipment.
Refer to external equipment operating guide.

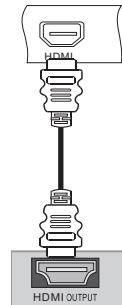

Note: The audio cable included with the TV should be used when connected with PC/ COMPONENT/S-VIDEO.

One side connected with the AUDIO IN terminal on the TV and the other side with right and left track connected with the corresponding terminals of other equipment.

Basic Operating Instructions

Turn on the LCD-TV

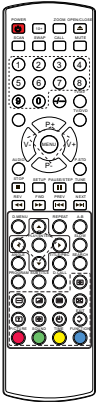

Switch on the power button on the back of the set and the TV will in standby mode. When the **POWER** button on the remote control is pressed and the LCD-TV is turned on, the indicator light on the front of the LCD-TV changes from red to green. When the LCD-TV is turned off using the **POWER** button, the LCD-TV will go into standby mode and the indicator light turns red.

Note:

The display of the input mode will disappear in about 8 seconds.

You can also turn on the TV from standby mode by pressing the digits(1-9) or P+/- .

Switch Among Different Inputs: PC/COMPONENT/DVD/HDMI/TV/SCART/SVIDEO

Each time you press the TV/AV button, TV, SCART , PC, COMPONENT, SVIDEO,HDMI, will appear on the screen in the order.

Each time you press the TV/DVD button, the current signal input and DVD will appear on the screen in the order.(When from DVD to other inputs, the DVD may operate about 10minutes)

Note:

The display of the input mode will disappear in about 8 seconds.

The display will appear on the screen when the TV is turned on the first time:
(Different displays for different countries, please see the real set)

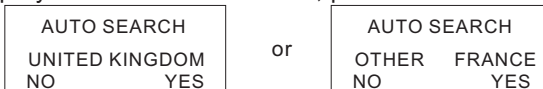

Press **V+/-** to adjust among **FRANCE**, **UNITED KINGDOM** and **OTHER** just according to the country you are in, **P+/-** to select the option and **MENU** to confirm.

Audio Control

- 1.Press the **V+** button to increase the volume. A number will appear on screen indicating the volume level.
- 2.Press the **V-** button to decrease the volume. A number will appear on screen indicating the volume level.

Mute

- 1.Press the **MUTE** button to mute the sound temporarily. A mute icon appears on the screen.
- 2.Press the **MUTE** button again or **V+/-** to restore the sound.
The mute icon disappears.

Basic Operating Instructions

Select the TV Channel You Want

You can use the number keys on the remote control to directly select TV channels.

The LCD-TV can store up to 100 channels, and you can press the keys on the remote control or on the panel to make a selection.

1. If you want to choose any channel from 0 to 9, please press the “-/--” button until “-” is indicated on the screen and then press the relevant key on the remote control. (for example: if you want to choose channel 8, just press the Key number 8.)
2. If you want to choose a channel bigger than 9, please press the “-/--” button until “--” is indicated on the screen. Enter the two digits of the channel number you want to watch.. (for example: select channel 16)

Note: if you want to choose one digit channel in this condition, you should press 0 first and then one digit number key.

Picture Mode

Press P.STD button on the remote control for menu display. For desired mode as follows:

PERSONAL → STANDARD → MILD → FRESH

Program Swap

- 1 Suppose the channel number you used just now is 8 and the channel number you are using is 18 (as shown in the figure).
- 2 If you want to return to the last watched program channel 8, you can simply press the SWAP button.
- 3 If you want to return to channel 18, press the button again. Through this function, you can easily change between the channel you are using and the channel you used last time.

Program Scan

- 1 Press the SCAN button to scan through all the memorized TV channels. The scan will pause for about 2 seconds on each channel.
- 2 If you want to stop the function during auto scanning, simply press the SCAN button again.

Menu Operations

* In this manual, the OSD (On Screen Display) may be different from your TV's because it is just an example to help you with the TV operation. Press TV/AV or TV/DVD to select the input source, and the menu in the different source is different.

1. Press **MENU** button to display the main menu, and **V+/V-** to select the main menu.
2. Press **P+/P-** to scroll through the options
3. Press **V+/V-** buttons to make changes to the parameters
4. Press the **EXIT** button to exit the menu

Picture Menu Options

Picture quality can be adjusted for any input separately.

The picture quality on the screen can be adjusted as follows:

1. Press **MENU** button and **V+/V-** until the following menu appears on the screen.
2. Press **P+/P-** button to enter the picture menu and to go up and down to select the desired option.

PC MENU

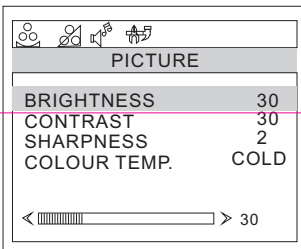

HDMI/COMPONENT MENU

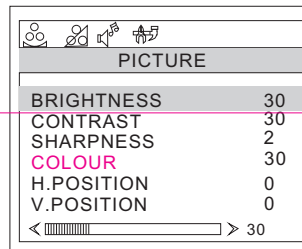

TV/SVIDEO/DVD/SCART MENU

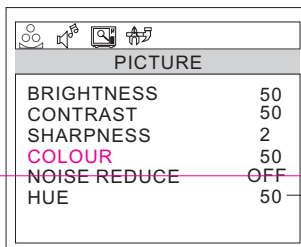

Only available in NTSC system

Note: Sign on top of the menu in this manual may be different from the real

Menu Operations

Picture Menu Options continued

3. Press **V+/V-** button to increase and decrease the level to adjust the selected option to your preference .
4. Repeat step 2 and step 3 until desired picture quality has been achieved .

Function:

BRIGHTNESS :Adjust the brightness of the picture . By increasing the level, it will add more light to dark parts of the picture and by decreasing the level ,it will add more dark to light parts of the picture.

CONTRAST : Adjust the contrast of the picture . The image becomes higher as the number increase.

SHARPNESS : Adjust the amount of the detail enhancement , the image sharpness rises as the number increases (By increasing the level, it will show cleaner and clearer images and by decreasing the level, it will make picture smoother).

COLOUR : Press **V+/V-** to adjust the colour

NOISE REDUCE:Adjust the quality of the picture by selecting OFF,LOW,MID,HIGH.

HUE : Adjust the tone of the picture . Appear and be adjusted only under NTSC mode

COLOUR TEMP. : Press to select the colour temperature from **WARM/NORMAL/COLD**

H.POSITION : Picture horizontal adjust

V.POSITION : Picture vertical position adjust .

Audio Menu Options

Sound can be adjusted for any input as follows:

1. Press **MENU** and **V+/V-** button until the following menu appears on the screen

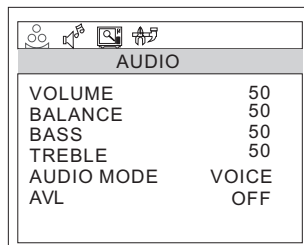

Menu Operations

Audio Menu Options continued

You can adjust sound options to the levels you prefer.

2. Press **P+/P-** button to enter the audio menu and to go up and down to select the desired option .
3. Press **V+/V-** button to increase and decrease the level to adjust the selected option to your preference .
4. Repeat step 2 and step 3 until desired sound quality has been achieved ..

Function :

VOLUME : Adjust the volume of your TV

BALANCE : Adjust the balance of the audio output from left to right . When indication value of balance increases toward +50 , sound of the left speaker becomes weaker . When indication value of balance decreases toward -50 , sound of the right speaker become weaker .

BASS : Adjust the bass of the sound . Can only be adjust under **PERSONAL** mode .

TREBLE : Adjust the treble of the sound . Can only be adjust under **PERSONAL** mode .

AUDIO MODE : Press **V+/V-** to select among **PERSONAL, VOICE, MUSIC** and **THEATRE** .

AVL : Automatic Volume Limit Control reduces the effect of the large volume by the same volume of all the channels .

Menu Operations

Function Menu Options

Menu Language Selection:

The menus can be shown on the screen in the selected language. First select your language.

1. Press **MENU** and **V+/V-** button until the following menu appears on the screen
2. Press **P+/P-** button to select **LANGUAGE**.
3. Press **V+/V-** button to select your desired language.

From this point on, the on-screen menus will be shown in the language of your choice.

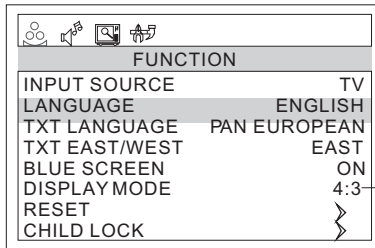

1. Press **MENU** button and **V+/V-** until the following menu appears on the screen.

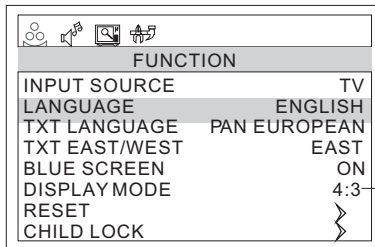

2. Press **P+/P-** button to enter the sound menu and to go up and down to select the desired option .
3. Press **V+/V-** button to increase and decrease the level to adjust the selected option to your preference .
4. Repeat step 2 and step 3 until desired picture quality has been achieved .

Functions:

1. **INPUT SOURCE** : Display current mode . There are **PC** , **COMPONENT** , **DVD** , **HDMI** , **TV** , **SCART** , **SVIDEO** to display
2. **TXT LANGUAGE**: To switch the teletext languages.
3. **TXT EAST/WEST**: To select **EAST** or **WEST** ..

Menu Operations

Function Menu Options Continued

4. **DISPLAY MODE**: To select the display mode between **4:3** and **FULL SCREEN**
5. **BLUE SCREEN**: To set **On**, the screen will be in blue screen after 3 seconds if there is no signal.
6. **RESET** : Press **V+** to reset some settings to the factory default .
7. **CHILD LOCK**: Press **V+** to enter it and the following appears on the screen:

PASSWORD: ----

If password is correctly entered, the CHILD LOCK menu will be entered. If the password is not correctly entered, you will be required to reenter the password and the cursor will stay at the first place. CHILD LOCK menu is as follows:
(The initial password is 0000.)

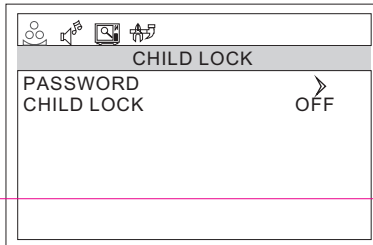

PASSWORD: The password can be changed. Press **P+/-** to select **PASSWORD** and **V+** to enter. The screen will display **NEW PW: ----**, then enter the new password and the screen display **CONFIRMPW: ----**, if the same password is entered correctly twice, the old password will be changed.

CHILD LOCK: Press **P+/-** button to select it. Press **V+/-** button to set on or off mode. If lock on mode is set, child lock is inactivated automatically. In such case, buttons on the television is useless and only buttons on remote control can be used, if child lock button (button on the television) is pressed, the screen will display **CHILD LOCK**. The child lock mode can be resumed by entering lock set menu, set child lock on .

Menu Operations

Adjust Menu Options

1. Press **MENU** and **V+/V-** button until the following menu appears on the screen

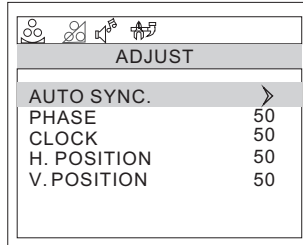

Note: This menu only appears in PC mode .

2. Press **P+/P-** button to enter the adjust menu and to group and down to select the desired option
3. Press **V+/V-** button to increase and decrease the level to adjust the selected option to your preference .
4. Repeat step 2 and step 3 until desired quality has been achieved.

Functions:

AUTO SYNC : Is opted for adjustment of picture location frequency and phase parameters .

PHASE : Removes any horizontal distortion and clears or sharpness the displayed characters .

CLOCK : Adjust the TFT-LCD to match the PC input source

H.POSITION : Picture horizontal adjust

V.POSITION : Picture vertical position adjust .

Menu Operations

Tuning Menu Options

1. Press **MENU** and **V+/V-** button until the following menu appears on the screen

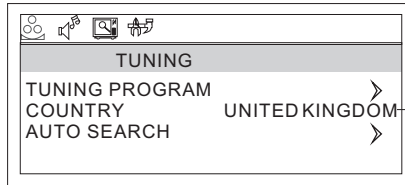

Only for some countries

Note: This menu only appears in TV mode .

2. Press **P+/P-** button to enter the tuning menu and to go up and down to select the desired option .
3. Press **V+/V-** button to increase and decrease the level to adjust the selected option to your preference .
4. Repeat step 2 and step 3 until desired quality has been achieved ..

Functions:

1. **TUNING PROGRAM:** Press **V+** to enter it and the **TUNING PROGRAM** menu appears:

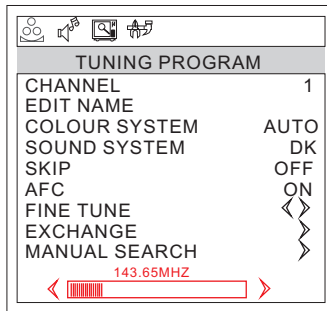

CHANNEL : Press **V+/V-** to change the TV channel .

EDIT NAME: Press **V+** to enter it , then press **V+/-** to select the position you want to edit and press **P+/-** to input the emblem such as character and so on. (There are 8 position for you to edit totally)

COLOUR SYSTEM : Select the TV color system from **AUTO, PAL, SECAM**.

SOUND SYSTEM : Select the TV standard system from **DK, I, L/L', BG**. (L' may be not available in some countries)

Menu Operations

Tuning Menu Options Continued

SKIP : If you want skip a channel , press **V+/V-** to select ON , and this channel will be skip next time when you press **P+/P-** . But you can press digits button to select the channel . If you want to restore the channel , select OFF.

AFC :Auto frequency control . Select ON to improve the image quality .

FINE TUNE :Press **P+/P-** to select FINE TUNE item in menu . Then , press **V+/V-** button to adjust and improve the image quality .

EXCHANGE : Press **V+** to display the menu as follows:

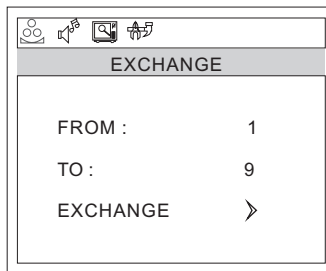

Press **P+/-** to select the item and then **V+/-** to adjust the channel and **V+** to confirm. (For example: press **P+/-** to select FROM item, and then press **V+/-** to adjust the channel number to 1; then Press **P+/-** to select TO item, and **V+/-** to adjust the channel number to 9; press **P+/-** to select EXCHANGE item, and then **V+** to confirm. The two channels will be exchanged)

MANUAL SEARCH: Press **V+** to start to search the channel . The following menu will display on the screen:

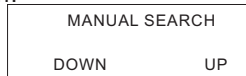

Press **V+/-** to select UP or DOWN, and then press MENU to confirm. (If you select DOWN, the search will search the lower frequency channel and UP will search the higher frequency channel)

2. **COUNTRY**: Press **V+/-** to select the country .

3. **AUTO SEARCH** : Auto search and save the channel .Press the **V+** button to start to search the channel and the following menu will appears on the screen:

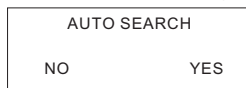

Press **V+/-** to select YES or NO, and menu to confirm. You could press MENU to stop the search.

NOTE: If you want to search the channels in L or L' system, you need to set the sound system to L in OSD

TELETEXT

- Teletext is an information system, broadcast by certain channels, which can be read like a newspaper . It also provides subtitles for people with hearing difficulties or those who are unfamiliar with the language in which a particular program is being broadcast (cable networks, satellite channels, etc.).

Note: The teletext buttons could be working even if there is no teletext signal, but there is no teletext display.

Teletext

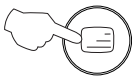
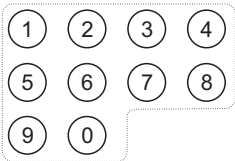
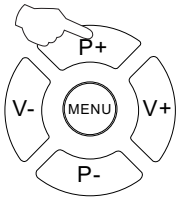

TUNE



Teletext functions

To select "Teletext" press the Teletext button on the handset. To switch off Teletext, press the button again. "Note all menu functions are not available in Teletext mode". Only a few direct button control functions are available in TELETEXT mode, they are:

- Volume adjustment
- Mute function

Page up/down

Use the P+/- buttons to browse next or previous page.

Page number entering

To select a Teletext page, enter the page number using the numeric key pad on the remote control, or use the P+ or P- buttons, or the coloured Fast text buttons.

Mix mode

To view the TV picture while in Text mode press the  button, this will superimpose the Teletext data on top of the Tv picture. Press this button again to return to Full text.

INDEX

Press the tune button to go to the index page of teletext.

TELETEXT

Teletext

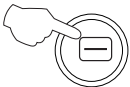
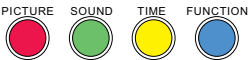
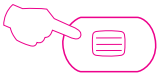

Cancel mode

This feature allows the TV picture to be displayed while next page to be searched is entered and found. Only the top teletext line is displayed until the page is found. Press the button to hide the teletext information. Either press the  button or the Text button to exit the cancel display mode.

Language change

Pressing the  button will change the Teletext characters between Eastern and Western.

Hold

Pressing the  button will stop the teletext page automatically updating. This feature is very useful where there are several teletext pages or data on the same page number.

Size

Pressing the  button changes between full screen top half bottom half full screen. This feature is very useful as it magnifies the image making the characters easier to read.

Reveal

Pressing the  button will reveal hidden text. This feature is used to reveal information such as answers to Teletext on-line interactive puzzles.

Subcode / Time

By entering its 4-digit number to enter a secondary page; While in normal TV mode only, pressing the button  will display the teletext time in the top right hand corner for a few seconds.

Switch teletext on/off

Press the  button on the remote control to turn teletext On/Off.

Fast text coloured buttons

Fast text automatically displays the four most commonly used pages that the broadcaster thinks that you may want to choose next. Press the same coloured button on the remote control as the coloured link at the bottom of the teletext page to go directly to that page.

Subtitle

Pressing the  button will get the teletext decoder to automatically search for the subtitle page.

Basic Playback

Basic Playback

Preparations

- Press the TV/DVD button on the front panel or TV/DVD on the remote control to enter the DVD status. Press the TV/DVD button on the front panel or TV/DVD on the remote control again to return to the TV mode.

Note: The unit do not allow enter DVD mode again after it have just left to avoid any damage of the DVD. Wait for 10 second to enter again.

Basic playback

1. Press OPEN/CLOSE to open the disc tray, place a disc on the disc tray. (If there is no disc placed on the disc tray in DVD mode, OPEN will display on the screen all the times)
 - There is only one disc size . Place the disc in the correct guide on the disc tray. If the disc is out of the guide, it may damage the disc and cause the DVD player to malfunction. Do not place a disc which is unplayable in this DVD player.
2. Press OPEN/CLOSE to close the disc tray, the playback will automatically start.
 - Some disc may not playback automatically, you can press PLAY/ENTER button to start playback.
3. Some disc may start playback with a menu, use the cursor button on the remote control to select menu options and press PLAY/ENTER to start, or press digits to select a menu options directly.

Pause playback

1. Press PAUSE/STEP to pause playback (still mode). The sound will be muted during still mode.
2. Press PLAY/ENTER to resume normal playback.

D.CALL

When pressing the D.CALL button repeatedly different OSD indicator will be displayed for different types of disc DVD, CD etc

Stop playback

1. Press STOP ■ button to go to stop mode, the TV screen will show the start-up logo. For some disc the player can recall the location where stopped, such as DVDs and audio CDs.
2. Press ENTER/PLAY to resume playback from the location where playback is stopped.
3. Press STOP twice to stop completely.

Previous and Next

During playback, press PREV ◀◀ key can go back to the beginning of this chapter, then each press of this key will skip a chapter till the start of the disc. (note: Disc function may vary depending on disc format)

Each press of NEXT ▶▶ key during playback will skip the current chapter and play the next one.

Fast forward and Fast reverse

1. Press FWD ▶▶ to fast forward through the disc. Each time the FWD ▶▶ button is pressed, the fast forward motion speed changes. It would cycle through 2X, 4X, 8X, 16X, 32X and normal.
2. Press PLAY/ENTER to resume normal playback.
3. Press REV ◀◀ to fast reverse through the disc. Each time the REV ◀◀ button is pressed, the fast reverse motion speed changes. It would cycle through 2X, 4X, 8X, 16X, 32X and normal.
4. Press PLAY/ENTER to resume normal playback.

Single step playback

1. Press the PAUSE/STEP button to pause the playback.
2. To view the next frame, press the PAUSE/STEP button. Each press of the PAUSE/STEP button advances the film by one frame.

ZOOM

Press this button can zoom enlarge or lessen the picture. Each time pressed the picture times will be change.

In zoom mode press navigation buttons to move the picture displayed on the screen

Advanced Playback

Advanced Playback

IMPORTANT NOTE:

ALL DESCRIBING FUNCTION IS FOR DVD DISCS. IF YOU PLAY OTHER FORMAT DISC, THE OPERATION AND DISPLAY ON SCREEN MAY DIFFERENT.

SUBTITLE

Press "SUBTITLE", the screen will display "SUBTITLE 01/XX XXXXX", "01" indicates the ordinal number of this language; "XX" indicates total number of language; "XXXXXX" indicates the language of country. (the number of language depends on disc). This function can select up to 32 languages displayed on screen.

REPEAT

Press REPEAT button multiple times to reach desired play mode:

DVD

Chapter repeat, Title repeat, All repeat

CD

Track repeat, All repeat

REPEAT A-B

Press A-B to mark the start-point, press again to set an end point to complete setting. The selected section A-B will be repeated immediately. Press the Repeat A-B again to cancel this function.

ANGLE

When enjoying sports, concert or theatre, press this key to watch same actions in different angles. (Valid for discs possessing this function. Using a disc recorded in multi-angle you can view the scene from different angles, for example, front, side, whole view and exterior scene.)

D.MENU

Press this key to display root menu, select item according to your preference. (This function will work with a DVD having a multi-layer menu.)

PROGRAM

When playing discs, press "PROGRAM" to enter program mode. Press the digit buttons to select the program number that you want. When finished, move the cursor to select "START". This will start the program playback. If you want to cancel this function, press "STOP", then press "PLAY/ENTER".

SEARCH

Press "SEARCH" once to display the search menu. Use the up/down navigation buttons to select the item you require. Press PLAY/ENTER to confirm (CD press the search button several times to select the item). And then press the numeric buttons or navigation buttons to input the item you require. Press PLAY/ENTER to confirm.

SLOW PLAY

Press SLOW to play a disc in slow forward. Each time the SLOW button is pressed, the slow motion speed changes.

Press PLAY /ENTER to resume normal playback.

Note: This function is invalid for CD.

AUDIO

Press this key can change the audio mode.

such as: Audio 1/2: AC 3 2 CH English
Audio 2/2: AC 3 5.1 CH English

If you play CD disc, press this button can cycle among Mono Left, Mono Right, Mix-Mono and Stereo.

Note: When press this button continuously, you must above 3 seconds interval.

TITLE/PBC

With some DVD discs pressing this key will display the title menu. You can then use the digit buttons to select the item you prefer.

Special Function Playback

JPEG DISC PLAYBACK

Insert a Kodak picture CD or JPEG picture CD into the tray and the disc will be loaded automatically. If the disc type can be identified, the player will start showing the pictures one by one (slide show mode). If a navigation menu will be displayed use the navigation buttons to select a file, then press the PLAY/ENTER button.

Each picture in the CD will be displayed consecutively in a slide-show fashion and will be scaled to fit in the whole TV screen. Some slide show transition modes are provided, use "PROGRAM" key to select. Customer can set transition effects for each picture.

To display an image indefinitely, press the "PAUSE" key. To view the next or previous picture, press "NEXT" or "PREV" key. To resume the slide show, press the "PLAY/ENTER" key.

Press the STOP button to preview the photos in a folder. Press navigation buttons to rotate a picture.

SCREEN SAVER FUNCTION

If this unit is not working by 3 minutes, it will go to sleep mode with screen saver on. In this mode, you can press any key on remote control or on front panel to activate the unit.

You can set SCREEN SAVER function to **OFF** in **GENERAL SETUP PAGE** of **DVD SYSTEM SETUP**.

DVD System Setup

DVD System Setup

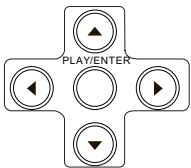
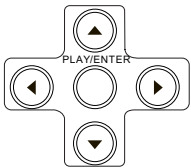

General Setup Process

1. Press the SETUP button, the General Setup Page, Preference Page will be displayed in turn.
2. Press ▲ or ▼ to select, the item, then press ► to enter the submenu.
3. Press ▲ or ▼ to select then press PLAY/ENTER to confirm.
4. Press EXIT key or press SETUP repeatedly to exit the set-up menus.

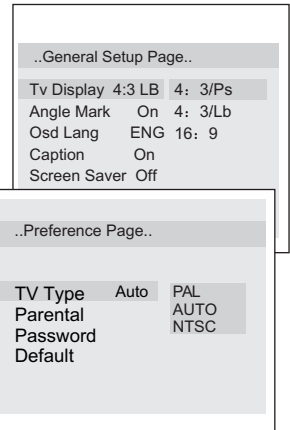

General Setup Page

ASPECT RATIO DESCRIPTION

When using the DVD with the internal TV, select **4: 3/LB**.

The following information applies only when the DVD output is connected to an external TV.

- **4: 3/PS** (PS = Pan and Scan)

You may select this if you have a normal aspect ratio (4:3) TV, although the NORMAL /LB (letter box) is a more common choice. In

PS mode, widescreen material will fill the screen, but at the expense of chopping off extreme left and right edges of the original film picture. For this feature to work, the disc must be specially coded. Such discs are uncommon.

- **4: 3/LB** (LB = Letter Box)

You may select this if you have a normal aspect ratio (4:3) TV. Widescreen material will be shown in pure unaltered form, allowing the entire picture area of the original film to be viewed without any side cropping. Black bars will appear above and below the picture.

- **16: 9**

You may select this if you have a widescreen (16:9) TV. Black bars may still appear above and below the picture even if using a widescreen TV. This is because some film directors prefer to use ultra widescreen aspect ratios e.g. 2.35:1. This will normally be indicated on the DVD packaging.

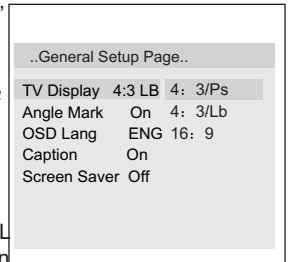

DVD System Setup(Continued)

DVD System Setup

General Setup Page

Angle Mark: Users can select a particular camera angle when playing a DVD which offers multiple angles.

This item allows you to set Angle Mark **ON** or **OFF**.

On Screen Display (OSD) Language: Users can select on-screen display language.

(The languages you can selected may differ from different countries or models, please see the real set)

Caption: This function allows you to display or hide the caption.

Screen Saver: If the screen saver is on, then there will be an animated picture of DVD on the screen whenever the DVD player is idle for more than 3 minutes .

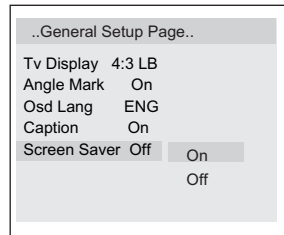
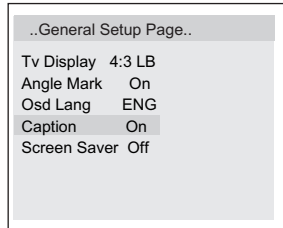
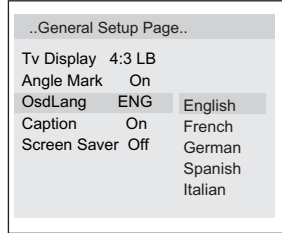
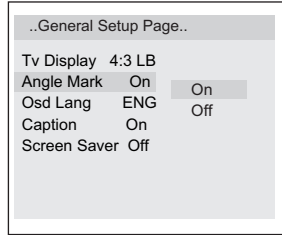

DVD System Setup(Continued)

DVD System Setup

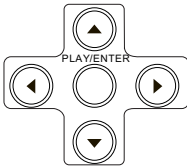

Preference Page

The Preference Page is only available when there is no disc in the player. These settings are applied consistently to all discs which are inserted and played.

TV Type: This player supports different TV output, including **MULTI(Auto)**, **NTSC**, and **PAL** systems. Usually please set to **MULTI**.

Parental: The parental control function works in conjunction with the different censorship classes assigned to DVDs. These classes help to control the types of DVDs that the family watches, There are up to 8 censorship classes for DVDs.

Note:

- 1 To change this setting you must enter your password. (Initial password is 1234)
- 2 When set to **OFF**, all discs may be viewed.

Password change:

You can change your password by entering 4 digits. You must confirm the 4 digits before the new password can be accepted.

NOTE:If you forget your password or a password is accidentally set enter 1369 as the password. This will enable you to regain control.

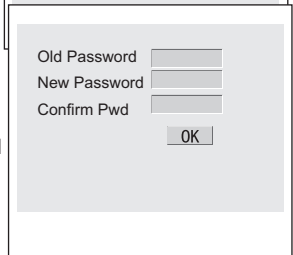
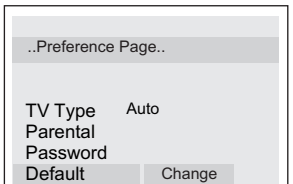
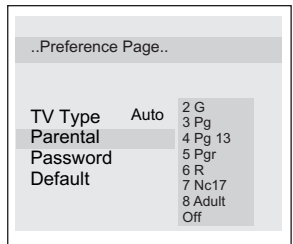
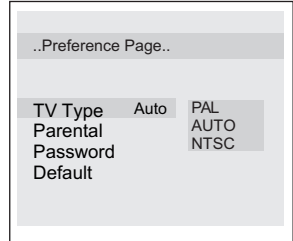

DVD System Setup(Continued)

DVD System Setup

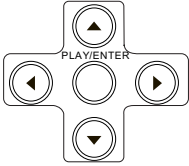

Default: Resets all settings (except password and parental lock status) for this DVD player back to the manufacturers original settings. Press ENTER to perform the reset.

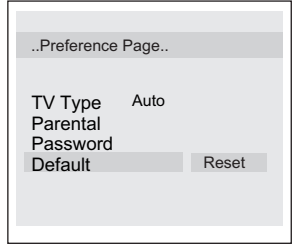





Note:

Some functions may not be available depending on the type of disc.

Playable Discs

The following discs can be played:

DISCS	LABEL	CONTENTS	DIMENSION
DVD VIDEO		Audio +Video (moving picture)	12cm
AUDIO CD		Audio	12cm
JPEG		Video(picture)	12cm
KODAK CD		Video(picture)	12cm
CD-R	CD•R	Audio or Video (moving picture)	12cm
CD-RW	CD-RW	Audio or Video (moving picture)	12cm
CD+G	CD+G	Audio(picture)	12cm

Support discs: DVD, CD-R, CD-RW, HDCD, JPEG, CD+G, Kodak CD , W MA.

- You cannot play discs other than those listed above.
- You cannot play non-standardized discs, even if they may be labeled as above.
- The performance of CD-R or CD-RW disc is depend on the way of disc-burning. In a few cases, their performance may not be very well or even not playable.

Dics Protection and DVD Characteristics

ON HANDLING DISCS

- Do not touch the playback side of the disc.
- Do not attach paper or tape to disc.

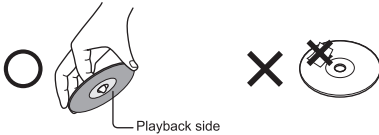

ON CLEANING DISCS

- Fingerprints and dust on the disc cause picture and sound deterioration. Wipe the disc from the centre outwards with a soft cloth. Always keep the disc clean.



- If you can not wipe off the dust with a soft cloth, wipe the disc lightly with a slightly moistened soft cloth and finish with a dry cloth.
- Do not use any type of solvent such as thinner, benzine, commercially available cleaners or anti-static spray for vinyl Lps. It may damage the disc.

ON STORING DISCS

- Do not store discs in a place subject to direct sunlight or near heat source.
- Do not store discs in place subject to moisture and dust such as a bathroom or near a humidifier.
- Store discs vertically in a case. Stacking or placing object on discs outside of their case may cause warping.

STRUCTURE OF DISC CONTENTS

Normally, DVD discs are divided into titles, and the titles are sub-divided into chapters. Audio CD are divided into tracks.

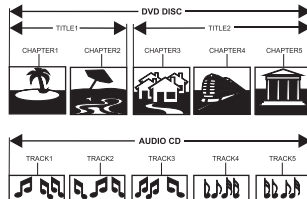

Each title, chapter, or track is assigned a number, which is called title number, chapter number or track number respectively.

There may be discs that do not have these number.

Compare DVD disc with other discs:

	DVD				LD
Encode method	Digital/MPEG II				Analog
Capacity	Single-side single-layer 4.7G	Double-side single-layer 8.5G	Single-side double-layer 9.4G	Double-side double-layer 17G	
Playing Time	133 minutes	242 minutes	266 minutes	484 minutes	Single-side 60 minutes double-side 120 minutes
Disc diameter	12cm				30cm/20cm
Horizontal resolution	More than 500 line				No more than 430 line
Picture proportion	Multiple kinds				One kind
Subtitle	32 kinds				16 kinds at most
Sound quality	48KHz, 96KHz/ 6, 20, 24bit				44, 1KHz/ 16bit

Troubleshooting Guide

- To assist in location possible faults use help guide below.

Troubleshooting

No picture, no sound	Verify if the television is properly plugged. Verify if the television is properly supplied power. Verify if electricity is available.
Blank screen	Verify if correct signals are input. Press TV/AV button to change signal input to TV input. Restart the television if power supply is interrupted.
No sound	Press MUTE button and verify if Mute mode is set. Switch to other channel and verify if the same problem happens. Press VOL+ button to see if the problem can be solved.
Poor sound	Verify if sound system is correct. Refer to some chapter for adjust.
No picture in some channel	Verify if correct channel is selected. Adjust the antenna. Make adjustments by FINE TUNE and MANUAL SEARCH .
No color for some channel program (black and white)	Verify if the same problem exists in other channels. Check out of picture and sound systems. Refer to relative instructions in the Manual for color adjust.
Spots with some or all pictures	Verify if the antenna is correctly connected. Verify if the antenna is in good condition. Make fine adjustment of channel.
Television out of control	Disconnect the television from power supply and, 10 seconds later, connect the television to the power supply. If the problem still exists, contact authorized after-sales service for technical assistance.

Note:

- 1.If the fault can not be repaired using the above guide consult with your local authorized service center.
- 2.The TV set must only be repaired by a qualified registered service person. Never attempt to remove the back cover as the TV set has dangerous voltages in side that may cause a fatality or fire.

Specifications

Specifications of the television that you have just purchased may vary from the information in this table due to technical innovations.

Model	L1510A-C, L15C10A, L1510B-C, L15C10B	L1920A-C, L1910A-C, L1910B-C L19C10A, L19C10B, L20C11W L1911W-C, L19C11W, L2011W-C, L1912W-C, L19C12W, L2012W-C, L20C12W
Picture, sound system	PAL/SECAM-B/G,I,D/K,L,L'	
Audio output	$\geq 1.5W+1.5W$	
External input port	COMPONENT input PC input S-VIDEO input Audio input Headphone output SCART Antenna input HDMI input	
Power requirements	~150-240V 50/60Hz	
Power consumption	$\leq 50W$	$\leq 60W$
Temperature	Working: 5°C~35°C Storage: -15°C~45°C	
Accessories	Remote control Batteries Owner's manual Audio cable Warranty card	

Note: Warranty card is only for the special countries and areas.

● **Note:**

All specifications are subject to change without notice.
All quality are approximate value.

Haier