

ECOWATER SYSTEMS
Countertop Water Filter With Monitor
Model CWF
Installation & Operating Manual

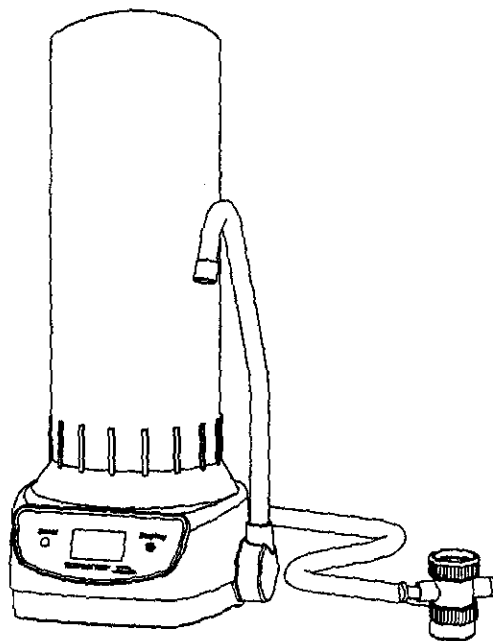

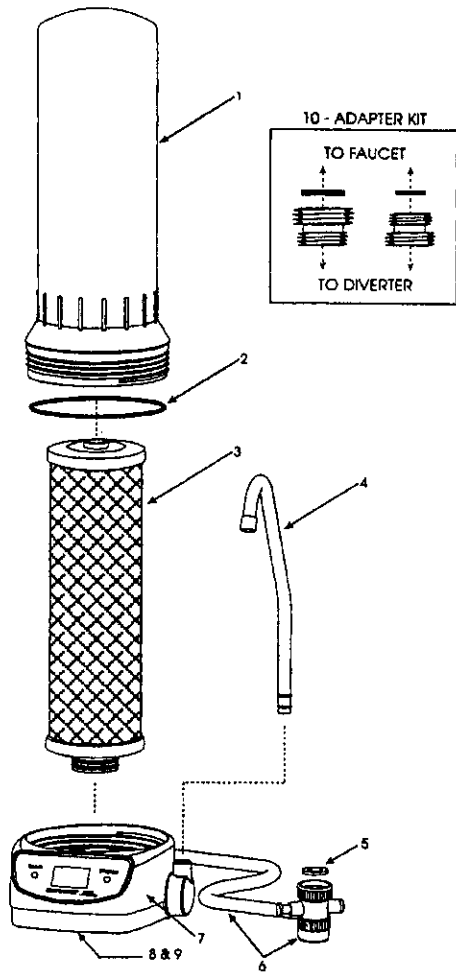

Figure 1

ECOWATER PARTS LIST:

Item#	Description
1	Housing
2	Housing O-ring
3	Filter, model RCCWF
4	Faucet
5	Diverter Gasket (two included)
6	Diverter & Tubing Assembly
7	Base Assembly
8	Battery Door (not shown)
9	AAA Batteries Included, not Installed, 2 necessary (not shown)
10	Adaptor Kit

INTRODUCTION

Thank you for purchasing your new EcoWater Countertop Water Filter with Monitor, an advanced filtration system combined with state-of-the-art electronic capacity monitoring.

Your new system was designed to be a convenient, portable, yet highly capable water filter for today's needs. Its integrated meter provides information on filter life.

ABOUT YOUR SYSTEM

Your new Countertop Water Filter features a combination of filtration technologies to reduce unwanted contaminants in a water supply.¹

The following technologies are combined in the unique multi-functional EcoWater RCCWF which reduces lead, taste and odor to give you clear sparkling drinking water:

First Stage: Mechanical Filtration

A melt blown polypropylene outer sleeve prefilters all water flowing through your system, reducing rust, sediment and other debris. This prefiltration significantly increases the life of the carbon block, therefore extending the life of the Filter.

Second Stage: Advanced Carbon Block Technology

The second stage utilizes carbon block technology and a special ATS² Sorbent Media to reduce taste and odors, chlorine and lead. The activated carbon block provides high adsorptive capacity and extreme uniformity at an economical cost. ATS utilizes a proprietary formulation to selectively reduce soluble lead from water supplies. Its speed and high capacity make it an ideal media for a single cartridge filter system.

Thank you again for purchasing your EcoWater Countertop Water Filter. We hope you will enjoy it as much as we enjoyed developing it for you.

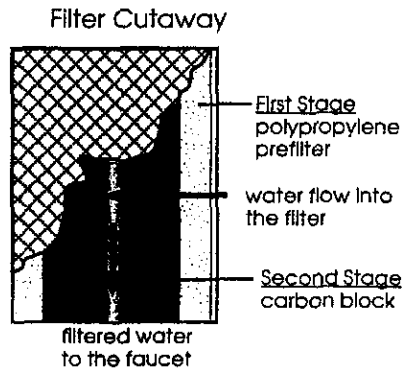

Figure 2

¹ See Performance Data Sheet for specific contaminant reduction.
² ATSSM is a trade mark of the Engelhard Corporation.

PRECAUTIONS:

1. Read the following precautions and installation instructions completely before beginning installation. Please note that this system should be installed in accordance with local laws and regulations.
2. This water filter is for use on **COLD WATER ONLY**. Hot water may damage the system. Maximum temperature is 100° F (38° C).
3. Protect the water filter and tubing from freezing temperatures. Failure to do so can cause damage and void warranty.
4. This system must be installed on microbiologically safe water.

START UP

1. Compare box contents with major parts list. (See Figure 1.) Please Note: The Filter is installed, ready for use.
2. Install the 2 AAA batteries in the bottom of the Filter Base assembly. Please note how batteries are to be installed by looking at diagram

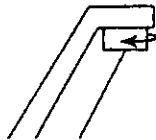

Figure 3

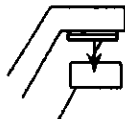

Figure 4

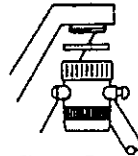

Figure 5

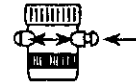

Figure 6

molded into battery compartment. Failure to properly install batteries can seriously damage the system.

3. Remove the existing faucet aerator by unscrewing. If the faucet aerator is difficult to remove, a pair of pliers with padded jaws may work. (See Figures 3 & 4.)

4. Remove the protective foam wrap from the diverter. Please note that there are two gaskets provided with the diverter. Use the thick gasket.

Thread the Diverter Valve onto the faucet "hand-tight" only. (See Figure 5.) Do not overtighten! Overtightening can damage the threads. If the diverter will not thread on properly, use the thin gasket. If the Diverter Valve is not compatible, an Adapter and Gasket Kit is provided to obtain a proper fit. (See Figure 1.)

5. To run water through the filter, turn on the COLD WATER faucet and slide the diverter mechanism. To stop the flow, turn off the cold water faucet or slide the diverter mechanism in the opposite direction. (See Figure 6.)

FLUSHING THE FILTER

On initial start up or after a Filter change, turn the water on and rinse the Filter for 5 minutes to remove carbon fines and expel excess air.

For best results, after setting over night or after several hours of non-use, turn the system on and rinse the filter for 15 seconds before using.

You are now ready to enjoy your EcoWater Countertop Water Filter.

NORMAL OPERATION

System performance and reduction of contaminants is determined by proper flow rate. This unit as tested under ANSI/ NSF Standards 53 & 42 must be used at a flow rate no greater than 0.75 gpm. Exceeding this flow rate will affect the ability of the system to reduce contaminant levels.

WATER METER OPERATION SECTION

Your Countertop Water Filter comes with a digital meter that shows you how much filter life is left at any given time. To preserve battery life the display is only activated when you draw water through the filter or press the "Display" button. There are three informational screens that can be viewed by pressing the display button.

Screen 1: Capacity Remaining

This display mode shows the remaining capacity of your filter in gallons, (see figure 7), in this case 500 gallons.

The unit of measure is either gallons or liters, depending on the programming at the factory. The water drops at the bottom of the screen graphically show how much of the capacity of your filter remains, much like a fuel gauge. By pressing the display button you can move on to the next display mode, Months Remaining.

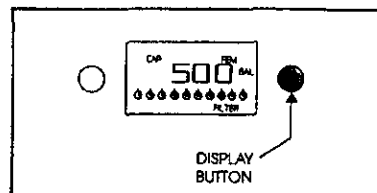

Figure 7

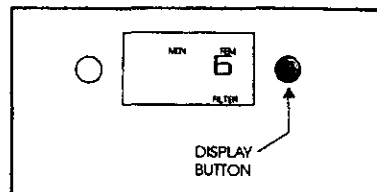

Figure 8

Screen 2: Months Remaining

This display mode shows the remaining capacity of your filter in months, in this case, 6 months. (See figure 8.)

By pressing the display button you can move on to the next display mode, Flow Rate.

Screen 3: Flow Rate

This display mode shows you at what rate water is flowing through your filter. (See figure 9.) This unit is designed and tested to operate at 0.75 gpm through the use of an internal flow restrictor that is dependant upon water pressure. As slight variations in water pressure may occur, your display may flicker between 0.7 and 0.8 gpm.

The drawing shows that water is flowing through your filter at 0.7 gallons per minute. (See figure 9.) The water drop scrolls along the gauge at the bottom as a second indicator that water is flowing through your filter and the water meter is working properly. Pushing the display button again would return you to Screen 1-Capacity Remaining.

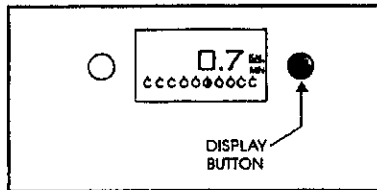

Figure 9

ALARM MODES

Advisory Beep - 50 gallons left

The water meter will alert you with an advisory beep when there is less than 50 gallons (200 liters) of capacity remaining in your filter. It is a single advisory beep that sounds every 5 seconds when you draw water, and only when you draw water. **We suggest you contact your supplier for a replacement filter as soon as you hear the advisory beep.** (See figure 10.)

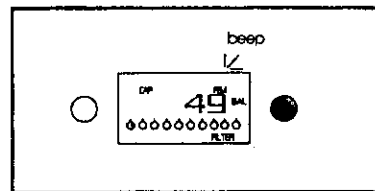
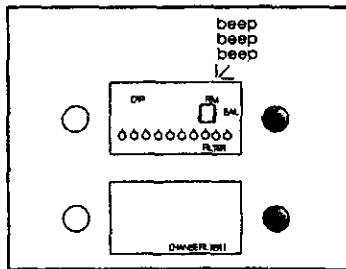

Figure 10

Alarm Beep - Filter capacity exhausted

The alarm beep sounds when the capacity of your filter has been exhausted. The water meter will sound three quick beeps when water is drawn. The display will alternate between "CHANGE FILTER 1" and the previous screen viewed. The display will continue to alternate until the filter has been changed and the meter has been reset. (See figure 11.)

Figure 11



water and scrub with a soft brush or sponge. Rinse thoroughly. Do not use abrasive pads or cleaners. Add 2 capfuls of unscented chlorine bleach to the Filter Housing and fill 2/3 full with cold water. Do not yet install the replacement Filter.

3. Leaving the chlorine solution in the Filter Housing screw the Filter Base assembly into the Filter Housing. When reassembling the Filter Housing to the Filter Base it is important that the rubber Housing O-Ring is properly seated in its groove in the Filter Housing or a water

CHANGING THE FILTER AND SANITIZING THE SYSTEM

The EcoWater RCCWF Filter has a rated life of 500 gallons or 6 months, however in certain water supplies, taste or odors may return or the flow may decrease prior to its rated capacity. In these cases the Filter should be replaced more often. To remove the exhausted Filter please refer to the following instructions:

1. There will be water in the Filter Housing so be sure to change filters over the sink. Hold the water filter upside down when removing the Filter Housing to reduce spillage. Unscrew the Filter Housing by holding onto the base assembly and turning the housing clockwise. (See Figure 12.) Discard the used Filter. Do Not discard the rubber Housing O-Ring.

2. Fill Filter Housing with warm soapy

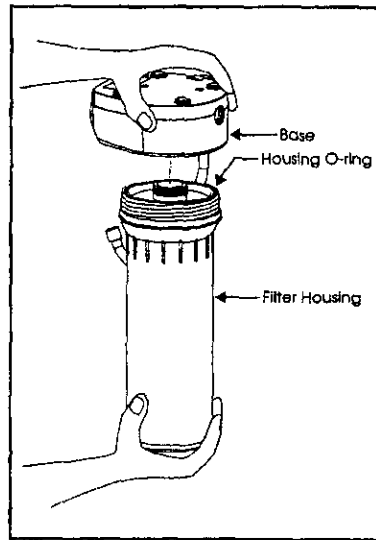

Figure 12

leak could occur. Place the Housing and Base right side-up with the Faucet pointing into the sink. Allow to stand for 15 minutes.

4. After 15 minutes, rinse the chlorine solution from the Housing and Base by turning on the COLD WATER faucet and sliding the diverter mechanism. The system will be adequately rinsed when no chlorine smell is present. Shut-off the cold water.

5. Again, hold the filter upside down, unscrew the Filter Housing by turning clockwise and empty.

6. Remove the plastic wrap and label from the replacement Filter and place it in the Filter Housing so that the end with the Cartridge O-Rings is facing outward (toward the base). Make sure that the Housing O-Ring is in the Filter Housing and screw the Filter Housing onto the Filter Base. (See Figure 12.)

7. Place the Filter System right side-up with the Faucet pointing into the sink. Rinse the Filter System for 5 minutes to remove carbon fines and expel excess air. Be certain to reset the meter after you have completely rinsed the system!

RESETTING THE WATER METER

CAUTION: After changing the filter you must reset your meter to monitor the life of your new filter. IT IS VERY IMPORTANT TO USE THE SAME KIND OF FILTERS THAT WERE SHIPPED WITH YOUR SYSTEM. THE VALUES THAT ARE PROGRAMMED INTO THE WATER METER APPLY ONLY TO THE SYSTEM MANUFACTURER'S FILTER.

TO RESET THE METER:

WARNING: Resetting the meter is irreversible. Please read the following instructions carefully.

Depress and hold the reset button until "RESET? FILTER 1" appears (2 seconds) then release the reset button. The "RESET?" will be flashing. (See Figure 13.)

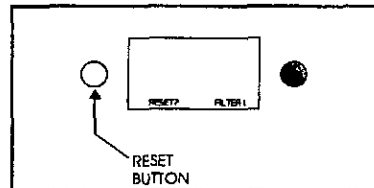

Figure 13

Press and hold the display button for 5 seconds to complete the filter reset. (See figure 14.) (Notice how the "?" disappears after RESET and it stops flashing). You will hear a confirming beep when the water meter has been reset. The

water meter has been reset and has returned to its original programmed capacities (500 gallons, 6 months).

If you do not complete the reset procedure successfully, wait for 30 seconds and try again.

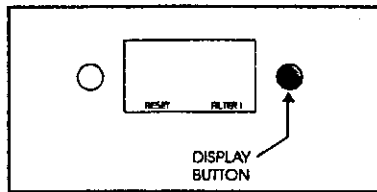

Figure 14

CHANGING THE BATTERIES

Under normal circumstances, the meter batteries should last 1-2 years. However, it is recommended that the batteries be replaced every year or when the low battery indicator appears on the screen ("BAT"). (See Figure 15.)

1. Change the batteries only while the water is turned off.
2. Turn the system upside down.
3. Open battery door on bottom of Filter Base assembly.
4. Remove both AAA batteries.
5. Note how batteries are to be installed by looking at diagram molded into battery compartment. Failure to properly install batteries can seriously damage the system. Replace with new batteries. Use only fresh batteries.
6. Close battery door.
7. Press Display to verify correct installation.

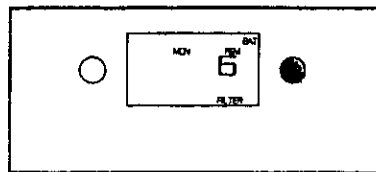

Figure 15

OPERATING PARAMETERS:

Water Pressure (min-max)	15 psi – 100 psi	103 kPa – 690 kPa
Temperature (min-max)	40°F – 100°F	4°C – 38°C
pH	6.5 – 8.5	6.5 – 8.5
Iron	0 ppm – 0.3 ppm	0 mg/L – 0.3 mg/L
Manganese	0 ppm – 0.05 ppm	0 mg/L – 0.05 mg/L
Hydrogen Sulfide	None	None
Turbidity	Less than 5 NTU	Less than 5 NTU
Bacteria ¹	Must be potable	Must be potable

PLEASE NOTE:

This System contains a replaceable Filter, model number RCCWF, which must be replaced at regular intervals to maintain proper performance. Use only factory approved filters. For parts or service, please contact the outlet where your unit was purchased or contact EcoWater at 1-800-86WATER (1-800-869-2837) or at the address below.

¹The RCCWF Cartridge does not filter or kill bacteria and viruses, do not use this system with water that is microbiologically unsafe or with water of unknown quality without adequate disinfection before or after the system.



This drinking water system conforms to ANSI/NSF Std. 53 for Lead and Turbidity reduction and ANSI/NSF Std 42 for Chlorine (Class I) and Taste and Odor reduction as verified and substantiated by test data. For conditions of use, health claims certified by the California Department of Health Services, and replacement parts, see product data sheet. California Dept. of Health Certificate Number 97-1311

Caution: Do not use with water that is microbiologically unsafe or of unknown quality without adequate disinfection before or after the system.

EcoWater Systems
PO Box 64420, St. Paul, MN 55164
1-800-869-2837