

FURUNO

OPERATOR'S MANUAL

DOPPLER SONAR
CURRENT INDICATOR

MODEL CI - 60G

PROVIDED WITH *NAV-AIDED* MODE
for absolute tide measurements in deep waters



FURUNO ELECTRIC CO., LTD.
NISHINOMIYA, JAPAN

©FURUNO ELECTRIC CO., LTD.

9-52, Ashihara-cho,
Nishinomiya, Japan 662

Telephone: 0798-65-2111
Telefax: 0798-65-4200

All rights reserved. Printed in Japan

-Your Local Agent/Dealer

FIRST EDITION : NOV 1991
G : AUG. 8, 1997

(TATA)

PUB. No. OME-72281
CI-60G





SAFETY INSTRUCTIONS

"DANGER", "WARNING" and "CAUTION" notices appear throughout this manual. It is the responsibility of the operator and installer of the equipment to read, understand and follow these notices. If you have any questions regarding these safety instructions, please contact a FURUNO agent or dealer.



DANGER

This notice indicates a potentially hazardous situation which, if not avoided, will result in death or serious injury.



WARNING

This notice indicates a potentially hazardous situation which, if not avoided, could result in death or serious injury.



CAUTION

This notice indicates a potentially hazardous situation which, if not avoided, could result in minor or moderate injury, or property damage.



SAFETY INSTRUCTIONS



DANGER



Do not open the equipment.

Hazardous voltage which will cause death or serious injury exists inside the equipment. Only qualified personnel should work inside the equipment.



WARNING

Do not disassemble or modify the equipment.

Fire, electrical shock or serious injury can result.

Turn off the power immediately if water leaks into the equipment or the equipment is emitting smoke or fire.

Continued use of the equipment can cause fire or electrical shock.

Do not place liquid-filled containers on the top of the equipment.

Fire or electrical shock can result if a liquid spills into the equipment.

Do not operate the equipment with wet hands.

Electrical shock can result.

Keep heater away from equipment.

Heat can alter equipment shape and melt the power cord, which can cause fire or electrical shock.



CAUTION

Use the proper fuse.

Use of a wrong fuse can result in fire or permanent equipment damage.

Do not use the equipment for other than its intended purpose.

Personal injury can result if the equipment is used as a chair or stepping stool, for example.

Do not place objects on the top of the equipment.

The equipment can overheat or personal injury can result if the object falls.

CONTENTS

TABLES FOR RECORDING USER PRESETS	iii
--	------------

GENERAL	1 to 14
--------------------------	----------------

1. FEATURES	2
2. SPECIFICATIONS	4
3. PRINCIPLE OF SPEED MEASUREMENT	8
4. TIDE, NAV-TIDE AND TIDE DIFFERENTIAL	11

CHAPTER 1. DISPLAY	1 – 1 to 1 – 18
-------------------------------------	------------------------

1. DISPLAY SAMPLES	1 – 2
2. HOW TO READ THE DISPLAY	1 – 3

FUNDAMENTAL DATA SECTION	1 – 4 to 1 – 9
---	-----------------------

SHIP'S SPEED/COURSE Display	1 – 4
TRACKING MODE Display	1 – 5
ERROR Status Display	1 – 6
TIDE SPEED/DIRECTION Display	1 – 7
PRESENT TIME Display	1 – 9
TRIP TIME/DISTANCE Display	1 – 9

DRIFT/TIDE DIF SECTION	1 – 10
---	---------------

SET & DRIFT Display	1 – 10
TIDE DIFFERENTIAL Display	1 – 10

TIDE VECTOR/COURSE PLOT SECTION	1 – 11 to 1 – 16
--	-------------------------

TIDE VECTOR Display	1 – 11
TIDE HISTORY Display	1 – 12
COURSE PLOT Display	1 – 13
TIDE EFFECT Display	1 – 14
DRIFT Display	1 – 16
HEAD-UP/NORTH-UP Presentation	1 – 16
RANGE CURSOR (VRM)	1 – 16

ECHO LEVEL SECTION	1 – 17
ECHO LEVEL Display	1 – 17
MISCELLANEOUS DATA	1 – 18
WATER TEMPERATURE Display	1 – 18
MISCELLANEOUS DATA Display	1 – 18
(Tide Averaging Time/Total Mileage/ Display Range)	
CHAPTER 2. OPERATION	2 – 1 to 2 – 4
1. CONTROL PANEL LAYOUT	2 – 2
2. FUNCTION OF KEYS & CONTROLS	2 – 3
3. OPERATING PROCEDURE	2 – 4
CHAPTER 3. SETTING OPERATING CONDITIONS (MENU WINDOWS)	3 – 1 to 3 – 13
1. BASIC MENU	3 – 2
MENU 1	3 – 3
MENU 2	3 – 4
MENU 3	3 – 5
MENU 4	3 – 6
2. RANGE SET MEMU	3 – 7
3. ALARM SET MENU	3 – 8
CHAPTER 4. TROUBLESHOOTING	4 – 1 to 4 – 5
1. SELF-CHECK	4 – 2
2. ERROR INDICATION	4 – 5
CHAPTER 5. DIP SWITCH SETTINGS	5 – 1

TABLES FOR RECORDING USER PRESETS

The CI-60G provides menus to preset, various measuring and display conditions to customize the equipment precisely for your operating conditions.

The form below is provided to record user presets, so they can be restored in the event of loss by misoperation or by maintenance/service work.

1) BASIC MENU (Display/measuring conditions)

[MENU 1]

ITEM	USER PRESET <input checked="" type="checkbox"/> : selected						FAC. SETTING
⊙ REF TIDE DIF	<input type="checkbox"/> LAYER1	<input type="checkbox"/> LAYER2	<input type="checkbox"/> LAYER3				LAYER1
* TIDE AVERAGE	<input type="checkbox"/> 0min	<input type="checkbox"/> 1min	<input type="checkbox"/> 2min	<input type="checkbox"/> 3min	<input type="checkbox"/> 4min	<input type="checkbox"/> 5min	2min (**)
⊙ TIDE HISTORY	<input type="checkbox"/> 15sec	<input type="checkbox"/> 1min	<input type="checkbox"/> 5min	<input type="checkbox"/> 10min	<input type="checkbox"/> 30min	<input type="checkbox"/> 60min	15sec
⊙ LAYER1	<input type="checkbox"/> ON	<input type="checkbox"/> OFF					ON
⊙ LAYER2	<input type="checkbox"/> ON	<input type="checkbox"/> OFF					ON
⊙ LAYER3	<input type="checkbox"/> ON	<input type="checkbox"/> OFF					ON
⊙ TIDE DIF DSP	<input type="checkbox"/> ON	<input type="checkbox"/> OFF					ON
⊙ DRIFT DSP	<input type="checkbox"/> DRIFT	<input type="checkbox"/> SPEED	<input type="checkbox"/> OFF				DRIFT
⊙ TEMP DSP	<input type="checkbox"/> ON	<input type="checkbox"/> OFF					OFF
⊙ ECHO LEV DSP	<input type="checkbox"/> COLOR	<input type="checkbox"/> GRAPH					COLOR
⊙ BACKGROUND	<input type="checkbox"/> NORMAL	<input type="checkbox"/> 1	<input type="checkbox"/> 2	<input type="checkbox"/> 3			NORMAL

(**) "2min" or longer averaging time is desirable to obtain stable and smooth response of tide/tide differential display.

[MENU 2]

ITEM	USER PRESET <input checked="" type="checkbox"/> : selected		FAC. SETTING
⊙ REF DEPTH	<input type="checkbox"/> OFF	<input type="checkbox"/> E/S	OFF
* MENU SELECT	<input type="checkbox"/> LOCK	<input type="checkbox"/> UNLOCK	LOCK

[MENU 3]

ITEM	USER PRESET <input checked="" type="checkbox"/> : selected				FAC. SETTING
⊙ SHIP SPD AVE	<input type="checkbox"/> 15sec	<input type="checkbox"/> 30sec	<input type="checkbox"/> 60sec	<input type="checkbox"/> 90sec	15sec
* DRAFT	[]m	0.0 to 25.6m			0.0m
* WT SPD DEPHT	[]m	2.0 to 25.6m			2.0m
* HEEL ANGLE	[]°	- 12.8 to +12.7°			0.0°
* TRIM ANGLE	[]°	- 12.8 to +12.7°			0.0°
* GT SPD CALIB	[]%	- 12.8 to +12.7%			0.0%
* WT SPD CALIB	[]%	- 12.8 to +12.7%			0.0%
* BEARNG CALIB	[]°	- 12.8 to +12.7°			0.0°
* EXT KP1 DIST	[]m	0.0 to 25.6m			0.0m
* EXT KP2 DIST	[]m	0.0 to 25.6m			0.0m
* BTM TIDE TRK	<input type="checkbox"/> OFF	<input type="checkbox"/> ON			OFF

[MENU 4]

ITEM	USER PRESET <input checked="" type="checkbox"/> : selected						FAC. SETTING
* TIME DATA	<input type="checkbox"/> INT	<input type="checkbox"/> EXT					INT
⊙ WT SPEED	<input type="checkbox"/> T/D	<input type="checkbox"/> NAV-TIDE					T/D
* NAV FORMAT	<input type="checkbox"/> CIF	<input type="checkbox"/> NMEA					CIF
* NAV AID	<input type="checkbox"/> GPS	<input type="checkbox"/> LORAN-C	<input type="checkbox"/> DECCA	<input type="checkbox"/> DR	<input type="checkbox"/> LORAN-A	<input type="checkbox"/> ALL	ALL
* NAV DATA	<input type="checkbox"/> L/L	<input type="checkbox"/> SPD					SPD
* TIME INT	[] min	1 to 10 min (in 1 min steps)					1 min
* CRS CAL MODE	<input type="checkbox"/> GT	<input type="checkbox"/> NAV	<input type="checkbox"/> MAN				GT
* CRS CAL EXEC	START	To start calibration, select START and press EVENT key.					--
* TIDE OUT INT	<input type="checkbox"/> 15 sec	<input type="checkbox"/> 30 sec	<input type="checkbox"/> 1 min	<input type="checkbox"/> 2 min	<input type="checkbox"/> 5 min	<input type="checkbox"/> 10 min	15 sec

2) RANGE MENU (Speed/distance/depth ranges)

ITEM	USER PRESET		FAC. SETTING
⊙ SPEED RANGE	[]KT	1.0 to 30.0KT	2.0KT
⊙ DIST RANGE	[]NM	0.1 to 5.0NM	1.0NM
⊙ ECHO DEPTH	[]m	50 to 400m	50m
⊙ ECHO SHIFT	[]	1 to 36	1

3) RANGE MENU

ITEM	SET ON/OFF	MIN	MAX	SP ON/OFF	FAC. SETTING
⊙ 1ST LAYER	SPD <input type="checkbox"/> ON <input type="checkbox"/> OFF	[]KT	[]KT	<input type="checkbox"/> ON <input type="checkbox"/> OFF	SET OFF / SP ON
	DIR <input type="checkbox"/> ON <input type="checkbox"/> OFF	[]°	[]°	<input type="checkbox"/> ON <input type="checkbox"/> OFF	SET OFF / SP ON
⊙ 2ND LAYER	SPD <input type="checkbox"/> ON <input type="checkbox"/> OFF	[]KT	[]KT	<input type="checkbox"/> ON <input type="checkbox"/> OFF	SET OFF / SP ON
	DIR <input type="checkbox"/> ON <input type="checkbox"/> OFF	[]°	[]°	<input type="checkbox"/> ON <input type="checkbox"/> OFF	SET OFF / SP ON
⊙ 3RD LAYER	SPD <input type="checkbox"/> ON <input type="checkbox"/> OFF	[]KT	[]KT	<input type="checkbox"/> ON <input type="checkbox"/> OFF	SET OFF / SP ON
	DIR <input type="checkbox"/> ON <input type="checkbox"/> OFF	[]°	[]°	<input type="checkbox"/> ON <input type="checkbox"/> OFF	SET OFF / SP ON
⊙ SHALLOW T/D	SPD <input type="checkbox"/> ON <input type="checkbox"/> OFF	[]KT	[]KT	<input type="checkbox"/> ON <input type="checkbox"/> OFF	SET OFF / SP ON
	DIR <input type="checkbox"/> ON <input type="checkbox"/> OFF	[]°	[]°	<input type="checkbox"/> ON <input type="checkbox"/> OFF	SET OFF / SP ON
⊙ DEEP T/D	SPD <input type="checkbox"/> ON <input type="checkbox"/> OFF	[]KT	[]KT	<input type="checkbox"/> ON <input type="checkbox"/> OFF	SET OFF / SP ON
	DIR <input type="checkbox"/> ON <input type="checkbox"/> OFF	[]°	[]°	<input type="checkbox"/> ON <input type="checkbox"/> OFF	SET OFF / SP ON
⊙ SHIP SPEED	SPD <input type="checkbox"/> ON <input type="checkbox"/> OFF	[]KT	[]KT	<input type="checkbox"/> ON <input type="checkbox"/> OFF	SET OFF / SP ON
	CRS <input type="checkbox"/> ON <input type="checkbox"/> OFF	[]°	[]°	<input type="checkbox"/> ON <input type="checkbox"/> OFF	SET OFF / SP ON
⊙ TRIP	DIST <input type="checkbox"/> ON <input type="checkbox"/> OFF	[]NM	[]NM	<input type="checkbox"/> ON <input type="checkbox"/> OFF	SET OFF / SP ON
	TIME <input type="checkbox"/> ON <input type="checkbox"/> OFF	[]	[]	<input type="checkbox"/> ON <input type="checkbox"/> OFF	SET OFF / SP ON

Marks on the ALARM MENU

Filled star (★): alarm active Hollow star (☆): alarm inactive

Active speaker (🔊): speaker enabled Inactive speaker (🔊): speaker disabled

- Note:
1. Descriptions of menu items and the procedures for presetting them begin on page 3-1.
 2. To clear user presets and automatically restore factory settings, select "FACTORY" on the BASIC MENU2- "MENU SET". (Note that the user presets for "TEMP DSP" and "ECHO LEV DSP" in MENU1 are not cleared by this operation.)
 3. Items marked with "⊙" are user changeable.
Items marked with "*" should not be changed needlessly once they are set at installation. Needless change can degrade the accuracy of measurements.

GENERAL

1. FEATURES	2
2. SPECIFICATIONS	4
3. PRINCIPLE OF SPEED MEASUREMENT	8
4. TIDE, NAV-TIDE AND TIDE DIFFERENTIAL	11

1. FEATURES

- Even in deep waters where ground (bottom) reference is not available acoustically, the CI-60G can provide absolute movements of measuring layers by receiving position (or speed) data from GPS navigator and heading data from gyro compass. It may be used on deep sea fishing boats or on ocean research vessels.
- The CI-60G consists of three major units; display unit, transceiver unit and hull unit (transducer), each compact enough to permit installation even on a small boat.
- Triple-beam system for automatic error compensation against pitching and rolling of vessel. Single-mold transducer makes installation easy while maintaining mechanical beaming accuracy.
- Sounding frequency of 244kHz provides high interference immunity from other acoustic equipments. Intelligent digital signal processing technique adds tracking stability and measuring accuracy.
- High-resolution 12" color display presents useful information for fishing, navigation and research both in text and graphics.
- Four kinds of background coloration for different lighting environments; easy to see for day and night.
- Simultaneous display of tide vectors and ship's course track on graphic screen.
- Echo level display always on screen. Permits constant monitoring of signal conditions of three sounding beams.
- Tide effect display plots movements of tides beneath the vessel's course track. Helpful in estimating three-dimensional deformation of cast net.
- Tide history display presents change of tide over last 24 sample points. (24 hours maximum)

- Friendly operation by means of logically arranged keys and menus; single key action for major function calls, and easy-to-use pop-up menus for setting various display/measuring conditions.
- Visual and audible alarms for ship's speed/bearing, tide speed/direction, tide speed/direction and trip time/distance. External speaker or other alarming device connectable for louder alarm sound.
- Possible to display water temperature graph of last 17.5 minutes. It is extremely helpful in detecting current rip or thermocline . (External temperature data required.)
- Accepts external depth data to permit stable ground tracking in critical depth. Provided also with manual ground acquisition facility to avoid tracking on false ground such as bottom fish or thick plankton.
- Raw data output port provided for collecting and analyzing current data on a separate computer.

2. SPECIFICATIONS

1. MEASURING RANGE

1) TIDE SPEED/DIRECTION

Speed: 0.0 to 9.9 kts
 Direction: All directions in one degree steps (True bearing if external heading input is available.)
 No. of measuring layers: Three layers
 Measurable depth of tide: Ground tracking mode

Water Depth (D)	Measurable Depth of Tide
$D < 13 \text{ m}$	Not measurable
$13 \text{ m} \leq D < 40 \text{ m}$	2 m to $(D - 10) \text{ m}$
$40 \text{ m} \leq D$	2 m to 120 m or 2 m to $(0.75 \times D) \text{ m}$

} Whichever is shallower.

Water tracking mode/Nav-aided mode (narrow pulse)

Water Depth (D)	Measurable Depth of Tide
$D < 40 \text{ m}$	Not measurable
$40 \text{ m} \leq D < 90 \text{ m}$	2 m to $(D - 10) \text{ m}$
$90 \text{ m} \leq D$	2 m to 120 m or 2 m to $(0.75 \times D) \text{ m}$

} Whichever is shallower.

Water tracking mode/Nav-aided mode (wide pulse)

Water Depth (D)	Measurable Depth of Tide
$D < 70 \text{ m}$	Not measurable
$70 \text{ m} \leq D < 140 \text{ m}$	2 m to $(D - 10) \text{ m}$
$140 \text{ m} \leq D$	2 m to 120 m or 2 m to $(0.75 \times D) \text{ m}$

} Whichever is shallower.

* Measurable depth is subject to change with water conditions, transducer site, amount of interference, etc. 100m is the maximum measurable depth of tide under typical conditions.

* Transmission pulse width selectable by an internal DIP switch.

2) SHIP'S SPEED/COURSE

Speed: [Fore - aft] +30.0 kts to - 10.0 kts
 [Port - stbd] +9.9 kts to - 9.9 kts
 Direction: All directions in one degree steps (True bearing if external heading input is available.)
 Measurable depth: Ground tracking mode
 3 m to 400 m typ. (Max. depth is subject to change with water conditions, transducer site, etc.)
Water tracking mode
 40 m or deeper (with narrow pulse)
 70 m or deeper (with wide pulse)

2. DISPLAY

1) DISPLAY DEVICE 12" high-resolution color CRT

2) DISPLAY ITEM

	<u>Text display (in table form)</u>	
Tide speed:	□ . □ (kt)	} (for 3 layers)
Tide direction:	□□□ (°) or 32-point notation	
Depth of tide layer:	□□□ (m)	
Ship's speed:	□□ . □ (kt)	
Ship's course:	□□□ (°) or 32-point notation	
Ship's heading:	□□□ . □ (°) (external data)	
Course calibration:	□□□ . □ (°)	
Present time:	□□ (h) □□ (m) □□ (s)	
Total mileage:	□□□□□ . □□ (nm)	

	<u>Optional text display (display on/off switchable)</u>	
Tide differential speed:	□ . □ (kt)	
Tide differential direction:	□□□ (°) or 32-point notation	
Lateral speed:	□□ . □ (kt)	
Drift angle (leeway angle):	□□ (°)	
Trip distance:	□□□□ . □□ (nm)	} alternative
Trip time:	□□ (h) □□ (m) □□ (s)	
Water temperature:	□□ . □ (°C) (Needs external data input.)	

	<u>Graphic display</u>
Tide vector:	Tide speed and direction for each layer are presented by length and pointing direction of a radial bar. Color of vector bar represents layer.
Tide differential vector:	Speed and direction of tide differential are presented by length and pointing direction of a radial bar. Colors of vector bar represent the layers involved.
Echo level:	Variation of echo strength with depth is presented either in color sounder mode or in A-scope mode. (simultaneously for three sounding beams)
Course track plot:	Ship's course track made of last 200 sampling points is presented in ship-centered format. (Display on/off switchable)
Tide history:	Tide vectors recorded at last 24 sampling points are presented on one screen. (24 hours max.)
Tide effect:	Simulated movements of tide layers below the ship's course track. (Display on/off switchable.)
Water temperature:	Water temperature graph over last 17.5 minutes are displayed. (External temperature data input required.)

3. ACCURACY

Tide speed: $\pm 2\%$ or ± 0.2 Kt, whichever is greater
Ship speed: $\pm 1\%$ or ± 0.1 Kt, whichever is greater

4. SOUNDING FREQUENCY

244 kHz approx.

5. EXTERNAL INPUT/OUTPUT

INPUT

Heading data: * Serial Signal 1 ch.
External keying pulse: * Current loop signal 2 ch.
Miscellaneous: * Serial Signal 1 ch.
Heading; (**HDT/HDM/HCD/HCC)
Depth; (**DBS/DBT/DBK)
W-temp; (**MTW)
Date/time: (**ZDA/ZLZ/ZZU)

OUTPUT

Log signal: * 200 pulses/nm (contact signal), fore only 2 ch.
(Contact capacity; 0.2 A/30 V max.)
* 400 pulses/nm (TTL level), fore only 1 ch.
True bearing data: * Serial Signal 1 ch.
External alarm: * Contact signal 1 ch.
(Contact capacity; 0.2 A/30 V)
* Speaker output 1 ch.
(800 mW into 4 to 8 ohms)
Keying pulse: * Current/TTL (pos/neg/dif) 1 ch.
Miscellaneous: * Serial Signal 1 ch.
Speed/course; (\$VDVTG/VHW/VBW)
Set & drift; (\$VDVDR)
Tide spd/dir; (\$VDVCD)
Complex: * Furuno CI-7000 format 1 ch.
(Date/time, ship's speed/course, tide speeds/directions,
water temperature, etc.)

6. MISCELLANEOUS FUNCTIONS

Self-check function,
Simple demonstration function

7. POWER SUPPLY

Main's input: 100/110/115/120/200/220/230/240 VAC, 50/60Hz, 1 ϕ
Power consumption: 300 VA average (800 VA peak)

8. ENVIRONMENTAL CONDITIONS

Temperature:	0 to 45 °C
Humidity:	80% RH (without condensation)

9. COATING COLOR

Display unit:	Front panel;	Munsell N1.5, Newtone No.5
	Cover plate;	Munsell 2.5GY5/1.5 (standard) or 2.5G7/2
Transceiver Unit:	Munsell 2.5GY7/2 (standard) or 2.5GY5/1.5	
Junction Box:	Munsell 2.5G7/2	

10. NAV-AIDED TIDE MEASUREMENT

Even where ground tracking is unattainable, absolute tide movements (tide on ground) can be calculated by applying accurate position and heading data to CI-60G. This function may be extremely useful in deep sea purse seining or in oceanographic survey.

To obtain accurate tide data against dynamic ship's movement, however, the speed and heading data must be applied from GPS navigator and gyro compass respectively. It is also desirable to use Furuno data format for interfacing. For further details, contact your Furuno agent.

- Note:
1. Depths are measured below transducer surface.
 2. The CI-60G uses an acoustic wave for speed measurements. Aeration due to rapid acceleration/deceleration, heavy engine/propeller vibration or interference from other sounding equipments can degrade performance of this equipment.
 3. Tide speed measurements are made by detecting echoes from underwater microscopic objects like plankton. If density of microscopic objects is too high or too low, depending on season or operating areas, CI-60G may not provide normal measuring performance.

3. PRINCIPLE OF MEASUREMENT

When a moving vessel emits an acoustical pulse into the water at an angle, a portion of emitted energy is reflected from the seabed and other microscopic objects in the sound path, such as plankton or air bubbles. The frequency of the received signal is shifted from the transmitted frequency in proportion to the relative velocity between the vessel and underwater reflecting objects. This is called Doppler Effect.

The CI-60G calculates and displays movements of ship and currents at specific depths by measuring Doppler shifts obtained from three separate directions.

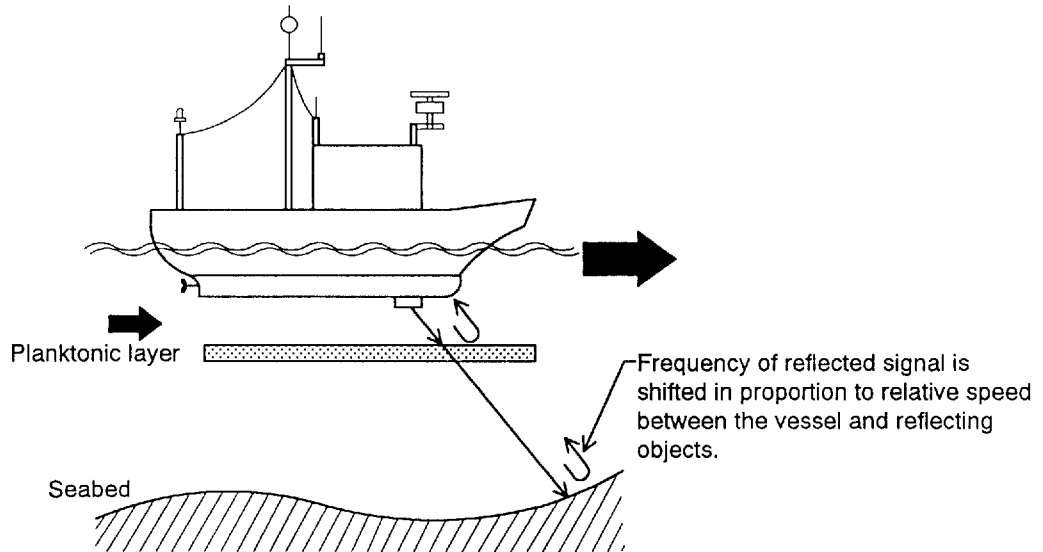

Ship's Speed (Here, speed is a vector value including velocity and direction.)

Depending on the base of measurement, ship's speed is expressed in two ways:

Ground tracking speed: Ship's speed and course relative to seabed (fixed base)
(Absolute speed)

Water tracking speed: Ship's speed and course relative to water layer just below the vessel (floating base)
(Relative speed)

Nav-aided speed: Ship's speed and course obtained by external navigation equipment (GPS)
(Absolute speed)

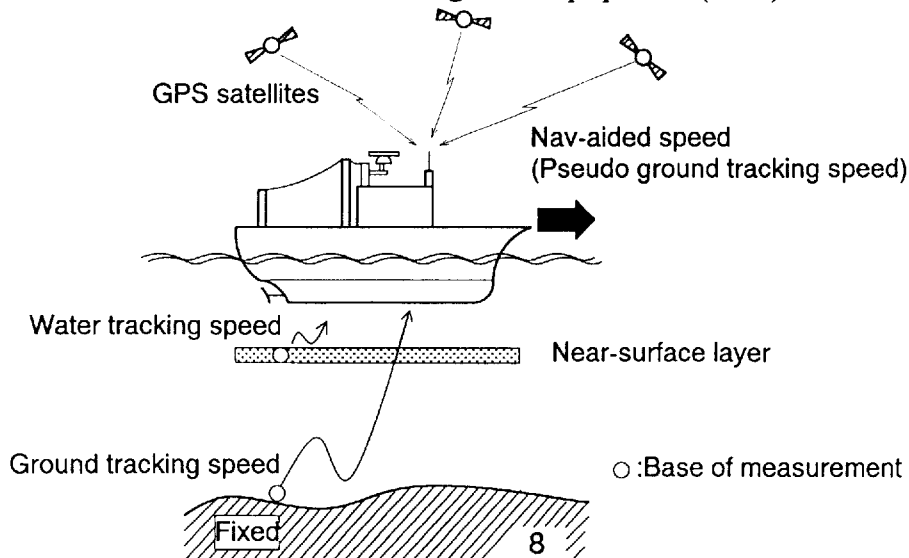

Tide

Tide is a movement of watermass at a particular depth.
 To know absolute tide (speed on ground), the following two data are required:

- ① Ship's speed and course based on ground
- ② Ship's speed and course based on measuring layer (A)

Absolute tide is, then, given as a difference of these two speed vectors.

Absolute Tide = ① - ②

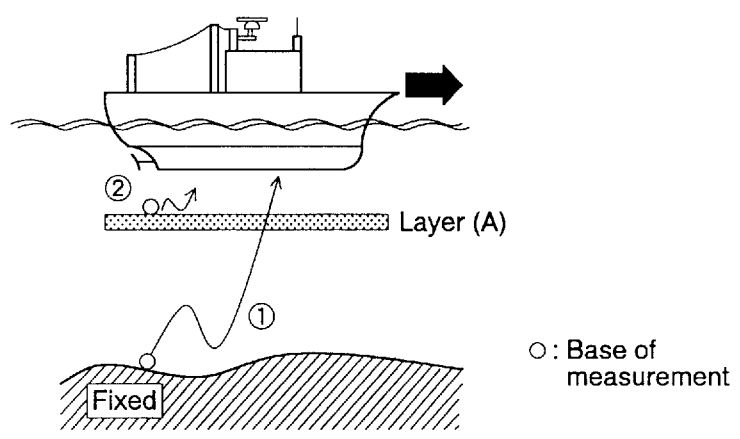

Nav-Tide

Nav-tide is an absolute movement of watermass at a particular depth, taking speed information from the external navigator (GPS) as a pseudo ground tracking speed.

To calculate Nav-tide, the following two data are required:

- ① Ship's speed and course obtained by external navigation equipment (GPS)
- ② Ship's speed and course based on measuring layer (A)

Nav-tide is, then, given as a difference of these two speed vectors.

Absolute Tide = ① - ②

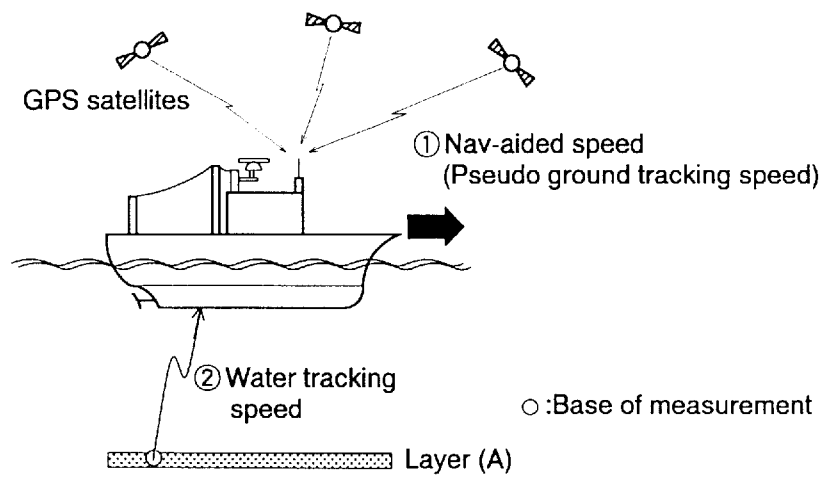

Tide Differential

Tide differential is a relative movement of tides at different depths, layer (A) and layer (B).

To calculate tide differential, the following two data are used:

- ① Ship's speed and course based on layer (A)
- ② Ship's speed and course based on layer (B)

Tide differential between two layers is, then, given as a difference of these two speed vectors.

$$\begin{aligned} \text{Tide Difference} &= \text{①} - \text{②} \quad (\text{Movement of layer B based on layer A}) \\ &\text{or} \\ &= \text{②} - \text{①} \quad (\text{Movement of layer A based on layer B}) \end{aligned}$$

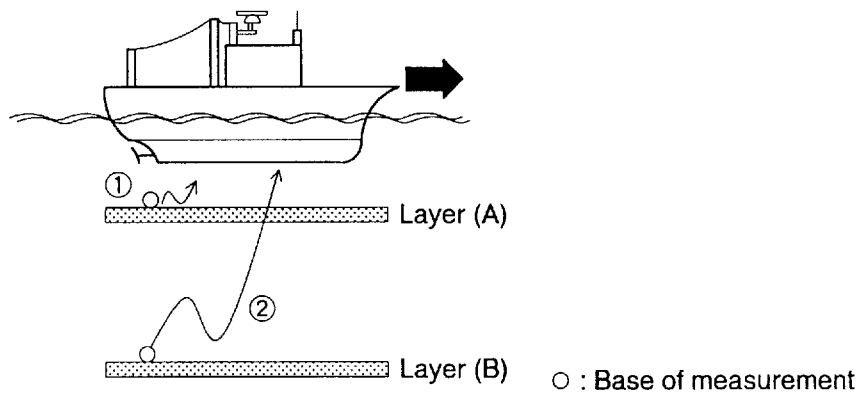

4. TIDE, NAV-TIDE & TIDE DIFFERENTIAL

Tide (Absolute tide)

Absolute tide can be measured in the ground tracking mode.

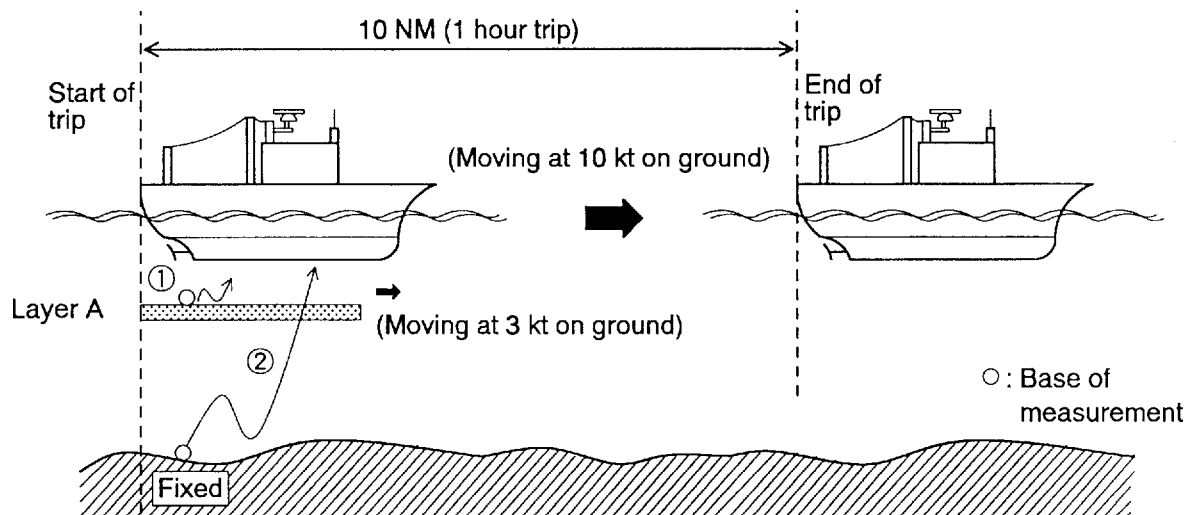

Assume that the ship and layer A are moving in the same direction, and ship's speeds based on ground (V_g) and on layer A (V_{wa}) are measured as;

$$V_g = 10 \text{ kt} \quad (\text{Ship's speed based on ground})$$

$$V_{wa} = 7 \text{ kt} \quad (\text{Ship's speed based on layer A}).$$

Speed of layer A based on ground (C_1) can be calculated as follows:

$$\begin{aligned} C_1 &= V_g - V_{wa} \\ &= 10 - 7 \\ &= 3 \text{ (kt)} \end{aligned}$$

Nav-Tide (Absolute tide)

Absolute tide can be measured in the nav-aided mode.

Nav-aided ship's speed (V_n) is equivalent to ship's ground tracking speed in the ideal conditions. That is, the nav-tide can be calculated by simply replacing V_g with V_n in the above equation.

Tide Differential

Tide differential is a relative movement of tides at different depths.
 It can be measured in the ground tracking, water tracking and nav-aided modes.

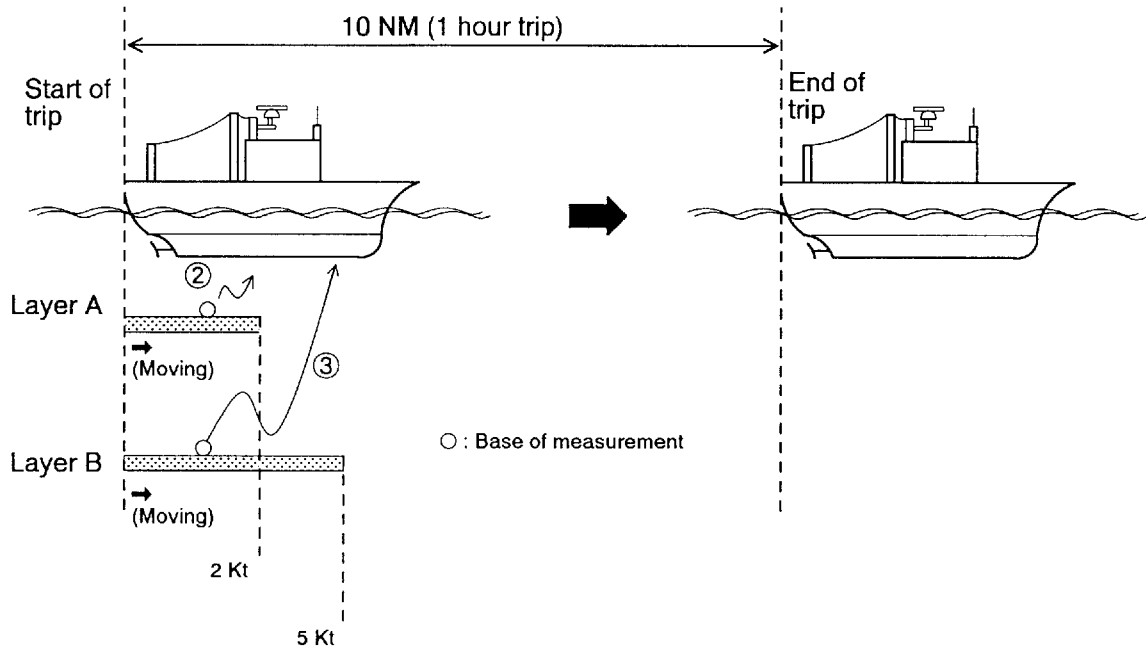

Assuming that the ship, layer A and layer B are moving in the same direction, and ship's speeds based on layer A (V_{wa}) and on layer B (V_{wb}) are measured as;

$$V_{wa} = 8 \text{ kt} \quad (\text{Ship's speed based on layer A})$$

$$V_{wb} = 5 \text{ kt} \quad (\text{Ship's speed based on layer B})$$

Tide differential calculations in ground tracking mode

As an absolute ship's speed (V_g) is available in the ground tracking mode, tide speeds of layer A (C_1) and layer B (C_2) based on ground are calculated as follows:

$$C_1 = V_g - V_{wa} \quad (\text{Speed of layer A based on ground})$$

$$C_2 = V_g - V_{wb} \quad (\text{Speed of layer B based on ground})$$

Thus, the tide differential (C_d) between layer A and layer B is;

$$\begin{aligned}
 C_d &= C_2 - C_1 \\
 &= (V_g - V_{wb}) - (V_g - V_{wa}) \\
 &= V_{wa} - V_{wb} \\
 &= 8 - 5 \\
 &= 3 \text{ (kt)}
 \end{aligned}
 \left. \vphantom{\begin{aligned} C_d &= C_2 - C_1 \\ &= (V_g - V_{wb}) - (V_g - V_{wa}) \\ &= V_{wa} - V_{wb} \\ &= 8 - 5 \\ &= 3 \text{ (kt)} \end{aligned}} \right\} \begin{array}{l} \text{Tide differential based on layer A} \\ \text{(Speed of layer B viewed from} \\ \text{layer A)} \end{array}$$

or

$$\begin{aligned}
 C_d &= C_1 - C_2 \\
 &= (V_g - V_{wa}) - (V_g - V_{wb}) \\
 &= V_{wb} - V_{wa} \\
 &= 5 - 8 \\
 &= -3 \text{ (kt)}
 \end{aligned}
 \left. \vphantom{\begin{aligned} C_d &= C_1 - C_2 \\ &= (V_g - V_{wa}) - (V_g - V_{wb}) \\ &= V_{wb} - V_{wa} \\ &= 5 - 8 \\ &= -3 \text{ (kt)} \right\} \begin{array}{l} \text{Tide differential based on layer B} \\ \text{(Speed of layer A viewed from} \\ \text{layer B)} \end{array}$$

In the water tracking mode, watermass just below the transducer (near-surface layer) is taken as the base of all measurements (virtual ground). Therefore, the ship and tide speeds in the water tracking mode are not absolute but relative to this near-surface layer.

$$\begin{aligned}
 V_w &= 9 \text{ kt} && \text{(Ship's speed based on near-surface layer)} \\
 V_{wa} &= 8 \text{ kt} && \text{(Ship's speed based on layer A)} \\
 V_{wb} &= 5 \text{ kt} && \text{(Ship's speed based on layer B)}
 \end{aligned}$$

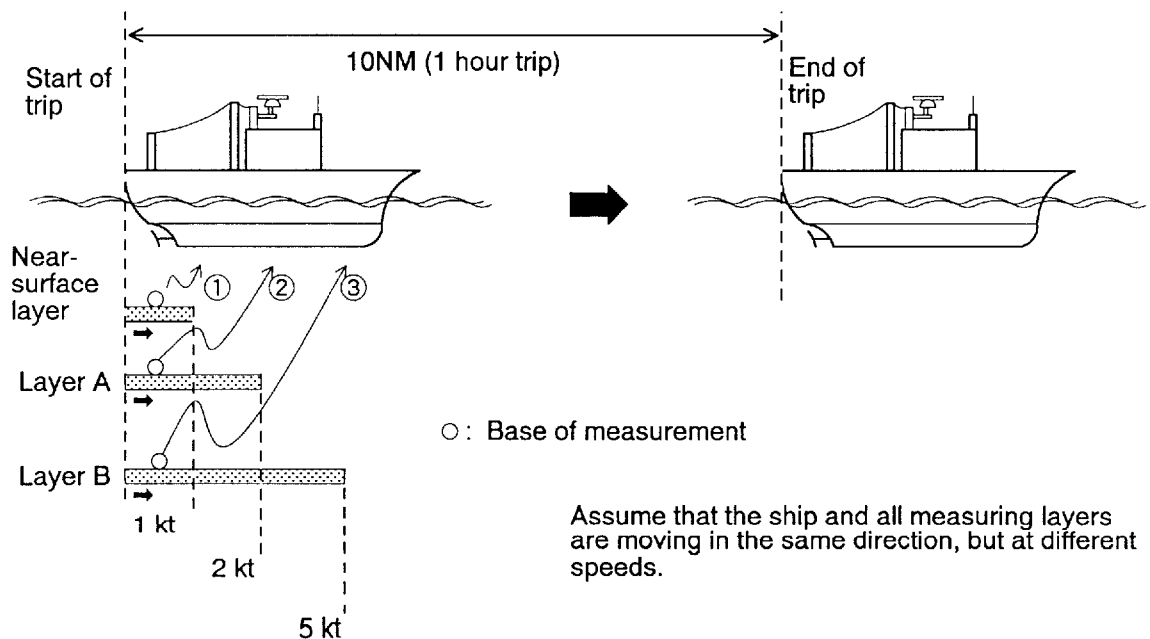

Tide differential calculations in water tracking mode

Tide speeds of layer A (C_1) and layer B (C_2) relative to near-surface layer (V_w) are calculated as follows:

$$D_1 = V_w - V_{wa} \quad (\text{Speed of layer A based on near-surface layer})$$

$$D_2 = V_w - V_{wb} \quad (\text{Speed of layer B based on near-surface layer})$$

The tide differential (D_d) between layers A and layer B is;

$$\begin{aligned} D_d &= D_2 - D_1 \\ &= (V_w - V_{wb}) - (V_w - V_{wa}) \\ &= V_{wa} - V_{wb} \\ &= 8 - 5 \\ &= 3 \text{ (kt)} \end{aligned} \left. \vphantom{\begin{aligned} D_d &= D_2 - D_1 \\ &= (V_w - V_{wb}) - (V_w - V_{wa}) \\ &= V_{wa} - V_{wb} \\ &= 8 - 5 \\ &= 3 \text{ (kt)} \end{aligned}} \right\} \begin{array}{l} \text{Tide differential based on layer A} \\ \text{(Speed of layer B viewed from} \\ \text{layer A)} \end{array}$$

or

$$\begin{aligned} D_d &= D_1 - D_2 \\ &= (V_w - V_{wa}) - (V_w - V_{wb}) \\ &= V_{wa} - V_{wb} \\ &= 5 - 8 \\ &= -3 \text{ (kt)} \end{aligned} \left. \vphantom{\begin{aligned} D_d &= D_1 - D_2 \\ &= (V_w - V_{wa}) - (V_w - V_{wb}) \\ &= V_{wa} - V_{wb} \\ &= 5 - 8 \\ &= -3 \text{ (kt)} \end{aligned}} \right\} \begin{array}{l} \text{Tide differential based on layer A} \\ \text{(Speed of layer A viewed from} \\ \text{layer B)} \end{array}$$

If you compare the results of calculations on this page with the ones on preceding pages, you will find the tide differential of two layers is identical irrespective of tracking mode.

CHAPTER 1. DISPLAY

1. DISPLAY SAMPLES	1 – 2
2. HOW TO READ DATA ON THE DISPLAY	1 – 3
FUNDAMENTAL DATA SECTION	1 – 4 to 1 – 9
SHIP'S SPEED/COURSE Display	1 – 4
TRACKING MODE Display	1 – 5
ERROR Status Display	1 – 6
TIDE SPEED/DIRECTION Display	1 – 7
PRESENT TIME Display	1 – 9
TRIP TIME/DISTANCE Display	1 – 9
DRIFT/TIDE DIF SECTION	1 – 10
SET & DRIFT Display	1 – 10
TIDE DIFFERENTIAL Display	1 – 10
TIDE VECTOR/COURSE PLOT SECTION	1 – 11 to 1 – 16
TIDE VECTOR Display	1 – 11
TIDE HISTORY Display	1 – 12
COURSE PLOT Display	1 – 13
TIDE EFFECT Display	1 – 14
DRIFT Display	1 – 16
HEAD-UP/NORTH-UP Presentation	1 – 16
RANGE CURSOR (VRM)	1 – 16
ECHO LEVEL SECTION	1 – 17
ECHO LEVEL Display	1 – 17
MISCELLANEOUS DATA	1 – 18
WATER TEMPERATURE Display	1 – 18
MISCELLANEOUS DATA Display	1 – 18
(Tide averaging time/Total mileage/Display range)	

1. DISPLAY SAMPLES

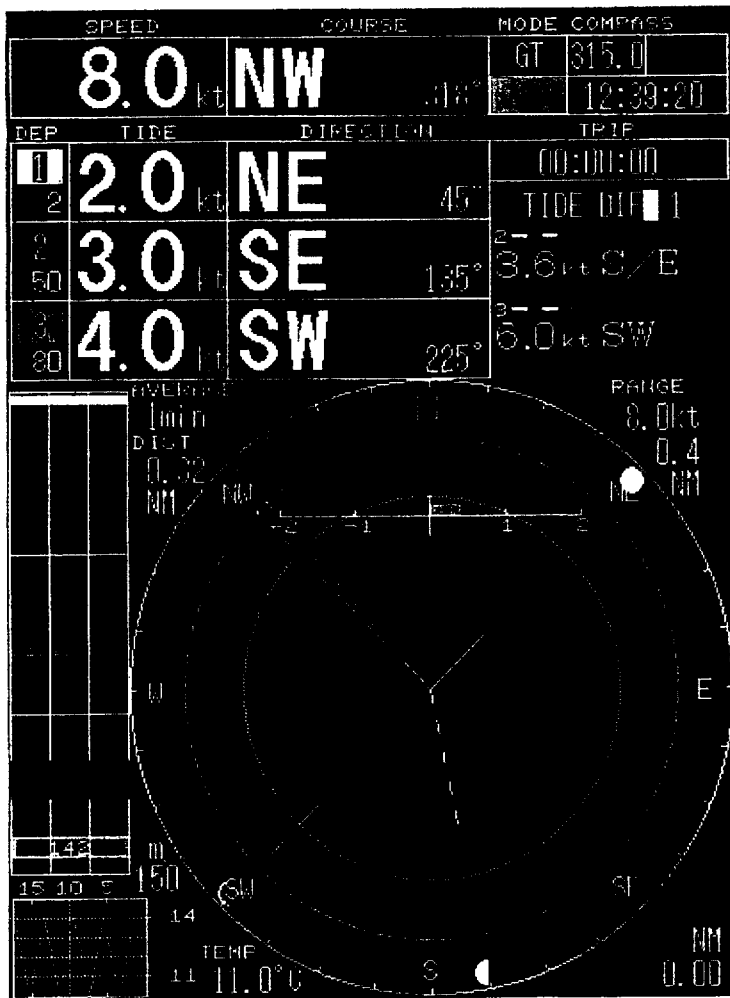

Sample 1

Ground Tracking Mode
(Ground echo available : GRN)

Tide Differential Display
(Based on layer 1)

Tide Vector Display
(North-up mode)

Ship's speed vector : GRN
Layer 1 tide vector : YEL
Layer 2 tide vector : PPL
Layer 3 tide vector : L-BLU
Tide dif. vector(1 → 2) : YEL/PPL
Tide dif. vector(1 → 3) : YEL/L-BLU

Fixed Range Ring(s): WHT ring
Range Cursor (VRM): GRN ring

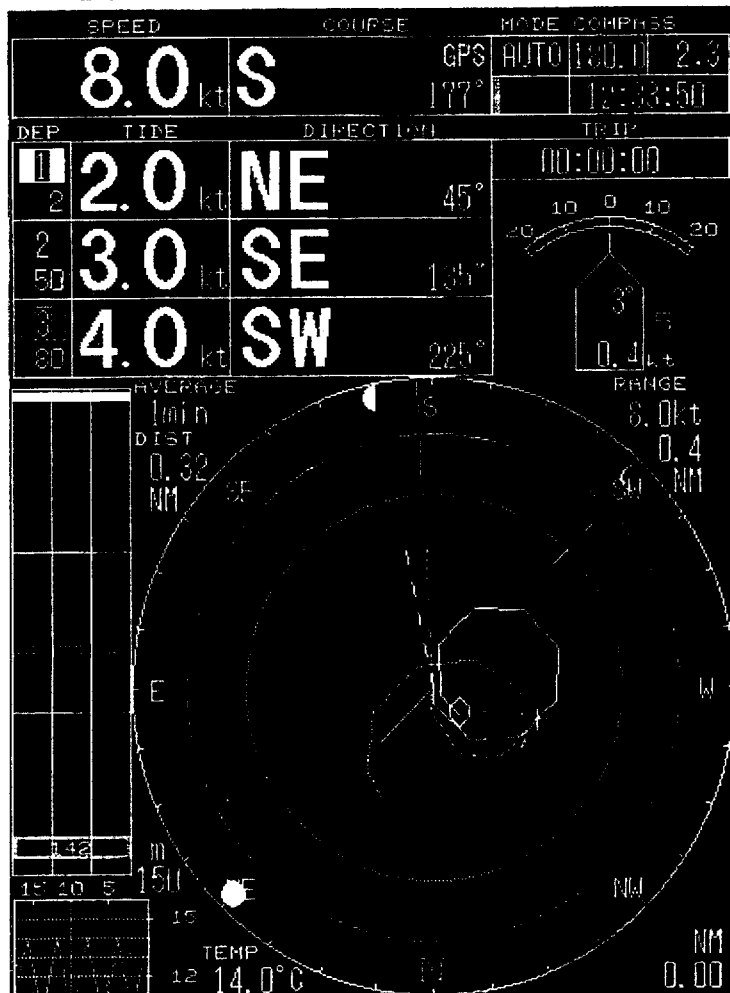

Sample 2

Auto-Tracking Mode
(Ground tracking : GRN
Nav-aided (GPS): BLU)

Drift Display
Set : Deviation of true course
from ship's heading
Drift : Lateral speed

Tide Vector/Course Plot/Tide Effect
Display (Head-up mode)

Ship's course track:
WHT line
Tide effect traces:
Colored dotted lines

Event mark (+)
Cast mark (○)* Start of tide effect
plotting

2. HOW TO READ THE DISPLAY

The display screen of the CI-60G is roughly divided into five sections as shown below. What is displayed in each section and how to use it is described on the following pages.

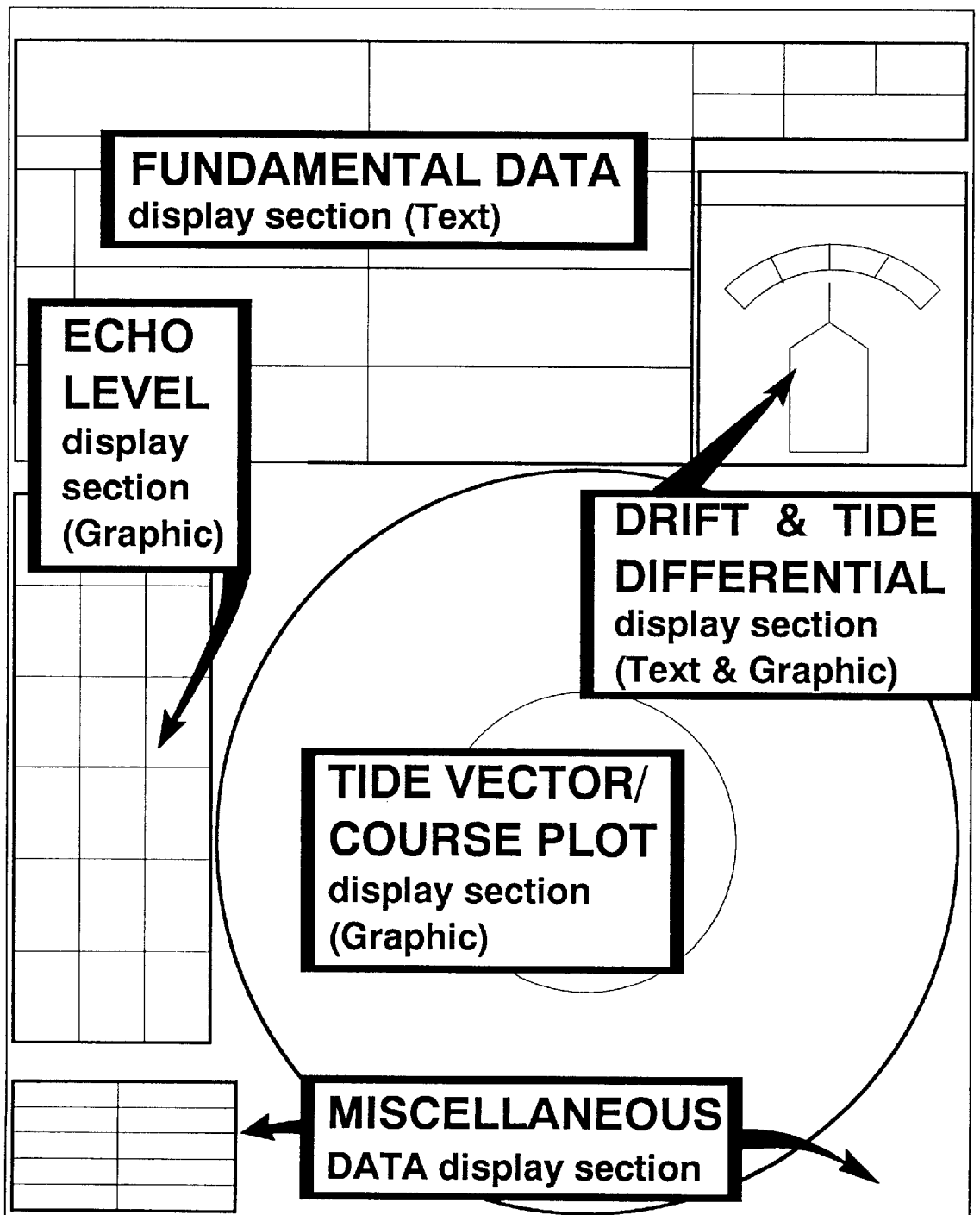

SHIP'S SPEED/COURSE Display

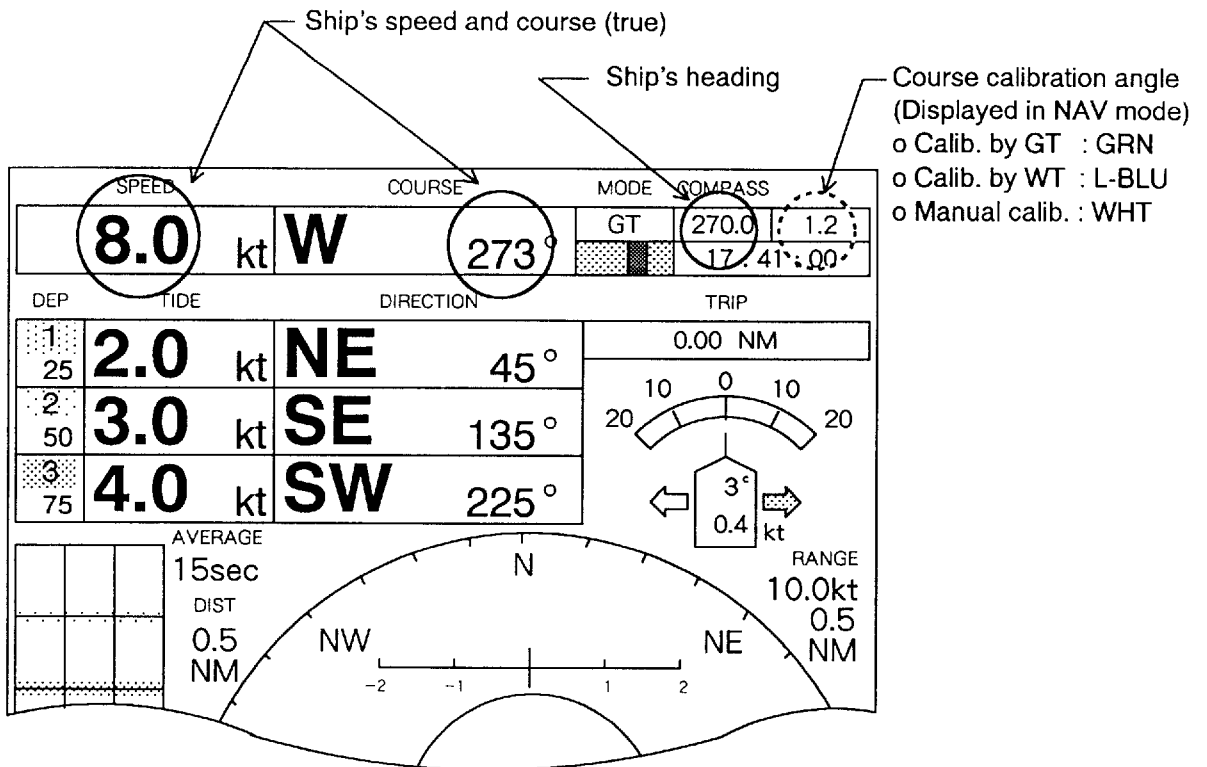

Note : The CI-60G updates ship's speed and course display in every 3 seconds with an averaging time selected in MENU 1. (See page 3-5 for averaging time setting.)

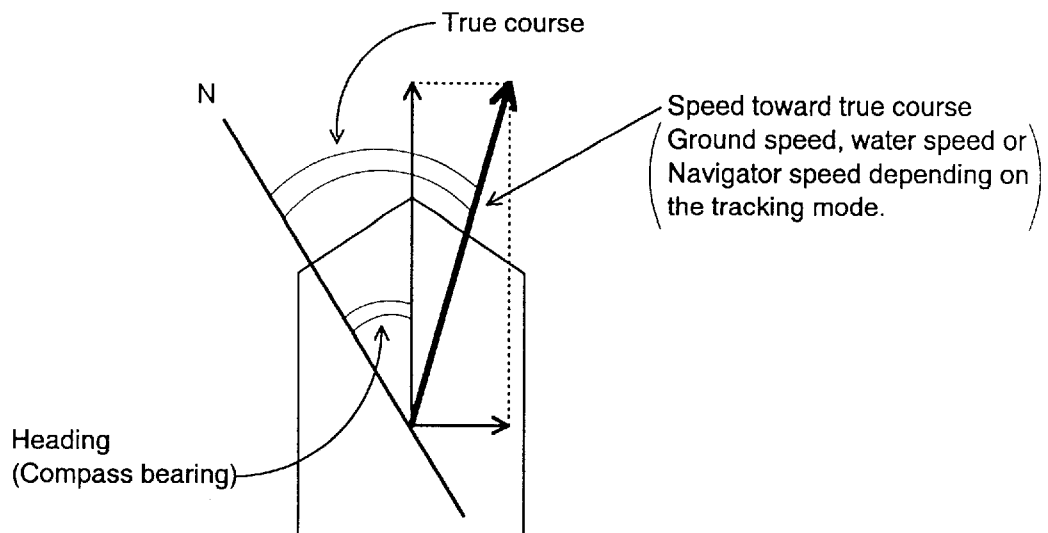

The course display appears in degrees and 32-point notation. If desired their locations can be swapped by changing the setting of an internal DIP switch. (See page 5-1.)

TRACKING MODE Display

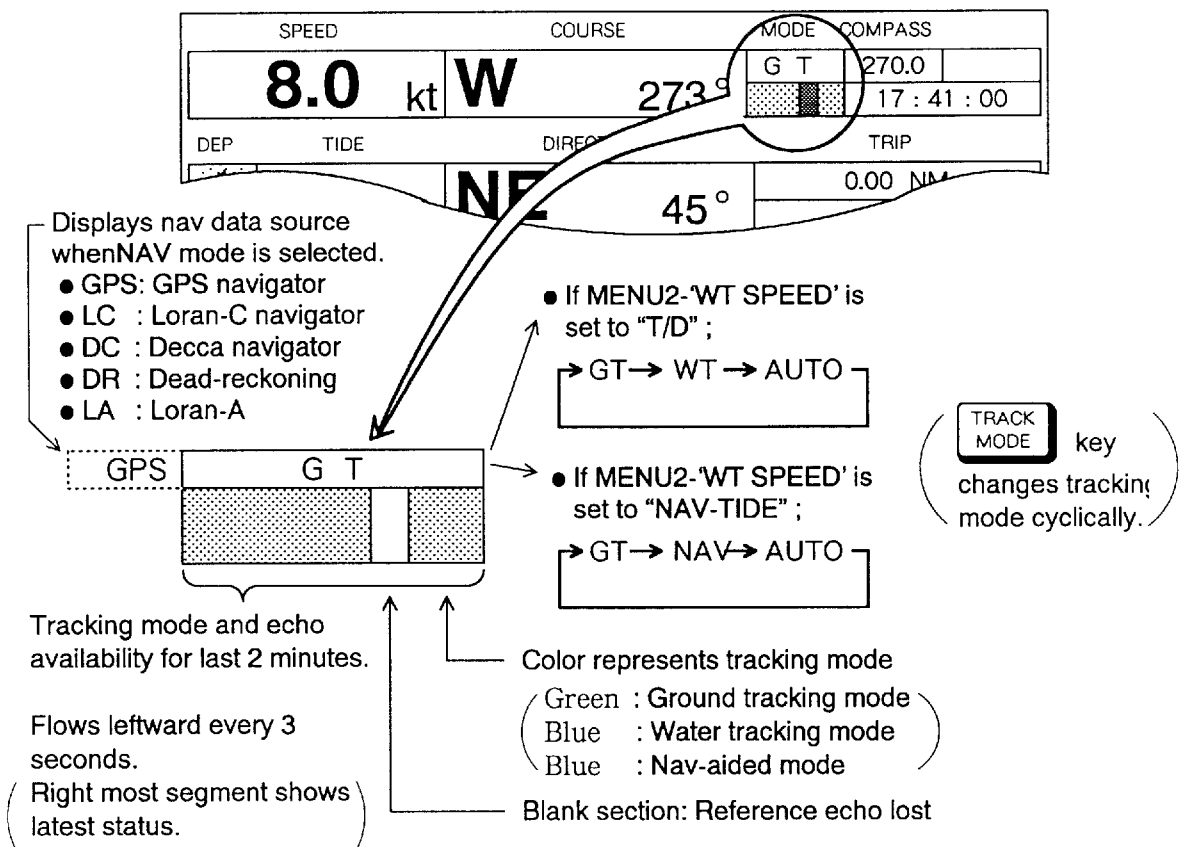

- **Ground Tracking Mode:** Shows absolute ship and tide movements based on ground. (* 1) (Bottom echo required.)
- **Water Tracking Mode :** Shows movements of ship and tide relative to near-surface water.
- **Nav-aided Mode :** Shows ship's movement measured by the external navigation equipment, and the tide movements based on the nav speed data.
- **Auto Tracking Mode :** Uses ground tracking mode when bottom echo is available. (* 2) Switches to water tracking mode (or nav-aided mode) when bottom echo is lost. Bottom echo is continuously searched for, and if re-acquired the ground tracking mode is restored.

(*1) Manual bottom acquisition is possible to disable unexpected bottom search when bottom echo is interrupted for a short period by air bubbles, or to avoid tracking on bottom fish. (See page 2-3 to enable manual ground tracking.)

(*2) For efficient and reliable bottom search in the auto tracking mode, depth data from an echo sounder can be used as a reference. In this case, "EXT" appears as a tracking mode identifier. (See page 3-4 to enable external depth input.)

ERROR Status display

When a source data for calculation and display seems to be abnormal, the following error indication appears on the display. This is to alert the operator not to rely on the related data.

No data from the Transceiver Unit.
(Red block mark above "kt")

No reference data for ship's speed.
("kt" in red box)

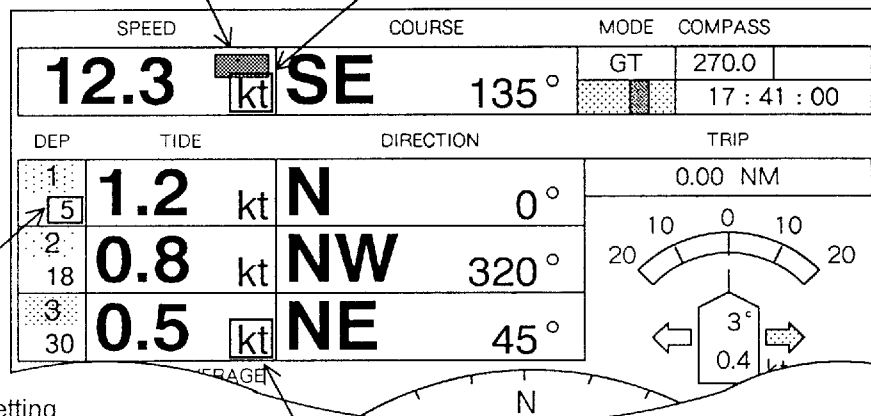

Invalid depth setting
(depth indication in red)

No echo from the layer.
("kt" in red box)

- ① If data is not received from the Transceiver Unit, a red square mark appears above "kt" in the SPEED display frame. As display data are not updated, do not rely on any data.
- ② If the reference data for ship's speed measurement is missing, the "kt" in the SPEED frame is enclosed in a red box. That is, no ground echo in the ground tracking mode, no reference water echo in the water tracking mode or no speed (position) data in the nav-aided mode. Do not rely on the ship's speed/course and all tide speed/direction display.
- ③ If echo from a particular layer is too weak the unit denotes it by circumscribing "kt" in the TIDE frame in red. Do not rely on the tide speed/direction of the layer.
- ④ If an invalid measuring depth (*) is set, the depth value for the layer appears in red.

(*) Measuring depth of shallower than 13 meters or deeper than 3/4 of seabed depth is regarded as invalid depths.

TIDE SPEED/DIRECTION Display (text)

Tide speeds/directions of three layers are displayed below the ship's speed/course. Depending on the tracking mode in use, the meaning of speed/direction changes as follows

- In the ground tracking mode, speed/direction values represent movement of the layer relative to ground. [Ground-based tide = Absolute tide]
- In the water tracking mode, speed/direction values represent movement of the layer relative to near-surface water. Strictly speaking, they do not represent tide but tide differential. [Surface-based tide = Relative tide]
- In the nav-aided mode, speed/direction values represent movement of the layer relative to pseudo ground. [Ground-based tide = Absolute tide]
(Note that accurate ship's speed/course and heading information must be applied to CI-60G to obtain reliable tide data.)

To set measuring depth of tide;

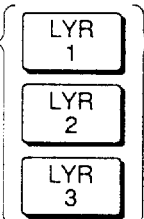
Select layer by  key, and turn ◀▶ knob to see desired depth.

Depth value of the selected layer appears in green. Press the same key again when desired depth is set. The depth value will return to white.

Layer 1 (Yellow).....
Layer 2 (Purple).....
Layer 3 (Lightblue).....

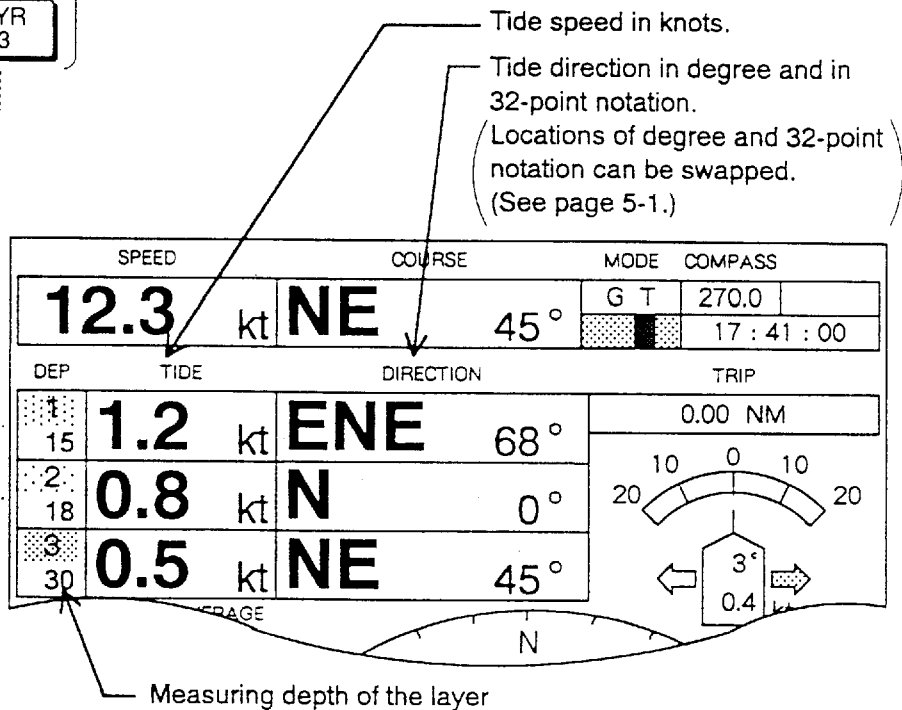

Note : Tide speed/direction display is updated every 3 seconds. The display is not raw data for every 3 seconds, but averaged for specified averaging time. (See page 3-3 to set averaging time for tide display.)

Ground Tracking Mode

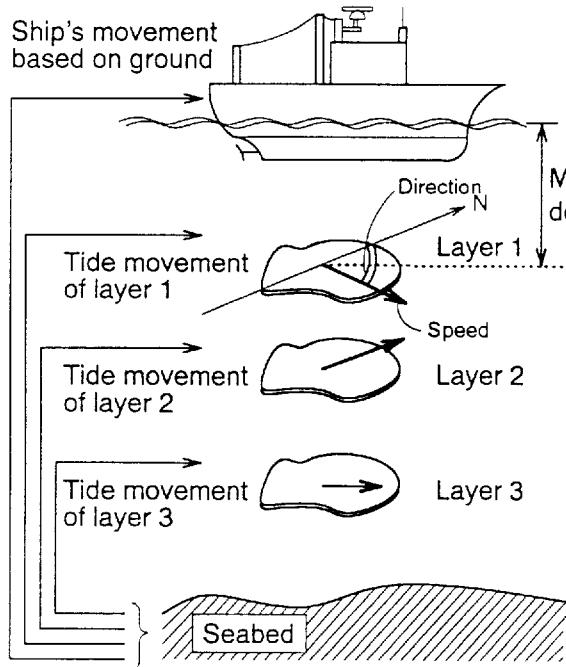

Water Tracking Mode

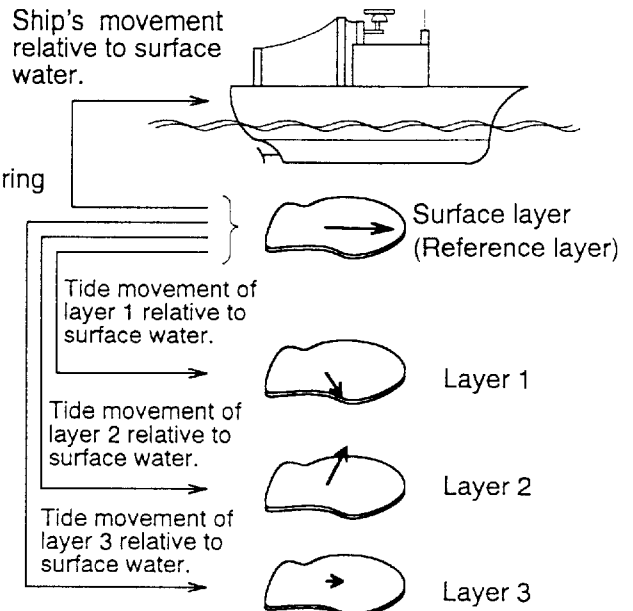

Nav-aided Mode

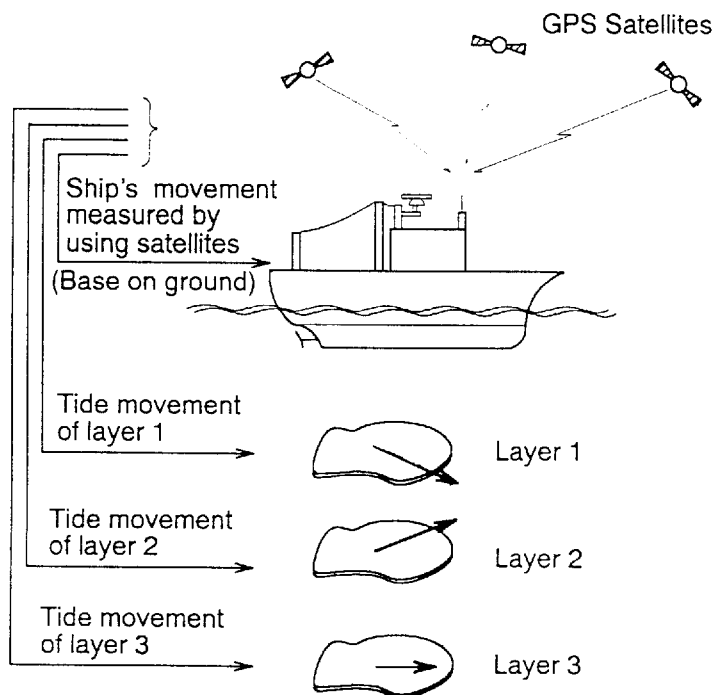

PRESENT TIME Display

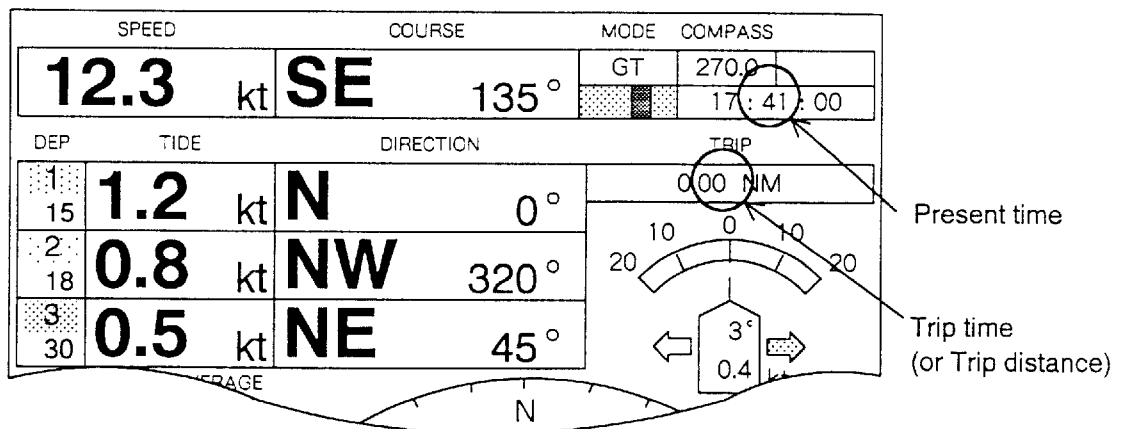

- Refer to page 3-4 to set date/time of the internal clock. (MENU 2 – “DATE/TIME”)
- It is possible to display time data received from the external navigation equipment, instead of the internal clock. However, the time display may not increment every one second since the time update depends on the incoming data interval. Refer to page 3-6 to use the external clock. (Set MENU 4 – “TIME DATA” to “EXT”.)
- Date is not displayed in the standard screen, but on top line in the MENU window.

TRIP TIME/DISTANCE Display

The TRIP function is used to measure distance-run in a certain time or time-elapsed to run a certain distance. It is also possible to cause audible and visible alarm when a certain time limit or distance limit is reached.

To set time limit or distance limit, call ALARM menu by the **ALARM** key and enter desired values in the “TRIP” option. (See page 3-12.)

Note that the time limit setting provides trip distance on the TRIP window, and the distance limit setting provides trip time display. (Time and distance are interlocked.)

To start trip count, press the **TRIP** key. The count increments as vessel moves or as time elapses.

When time limit or distance limit is reached, counting is stopped, the distance or time count in the TRIP window turns red, and the audible alarm, if enabled, sounds.

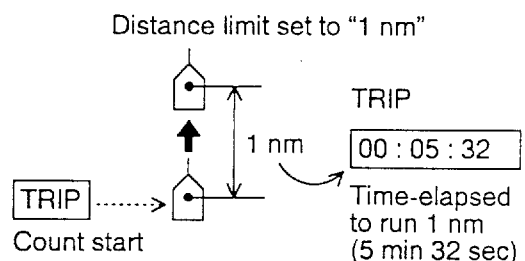

SET & DRIFT Display

Press the **DRIFT** key to call the set and drift display.

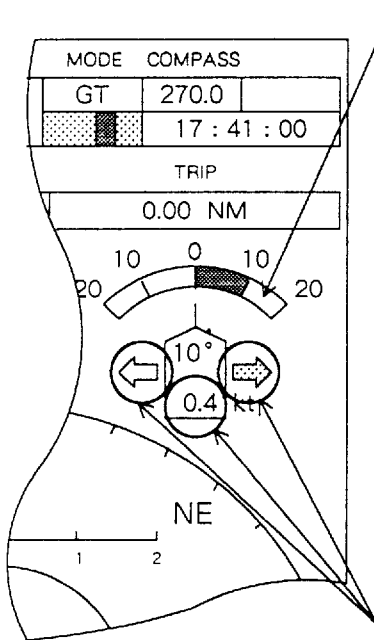

- ① Set angle (Leeway angle)
(20° port to 20° starboard)
Deviation of true course from ship's heading.
- ② Drift speed (lateral speed)
(9.9 kt port to 9.9 kt starboard)
Filled arrow shows drifting direction.

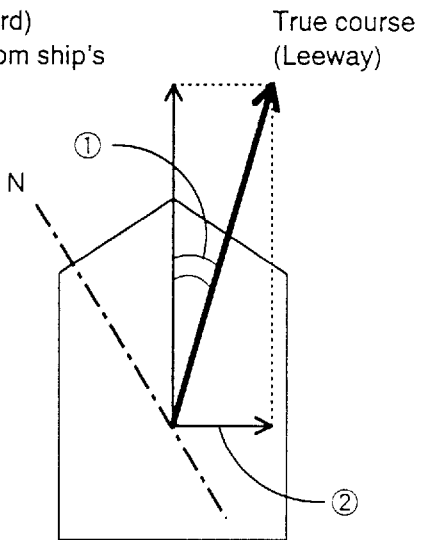

TIDE DIFFERENTIAL Display

Press the **TIDE DIF** key to call the tide differential display.

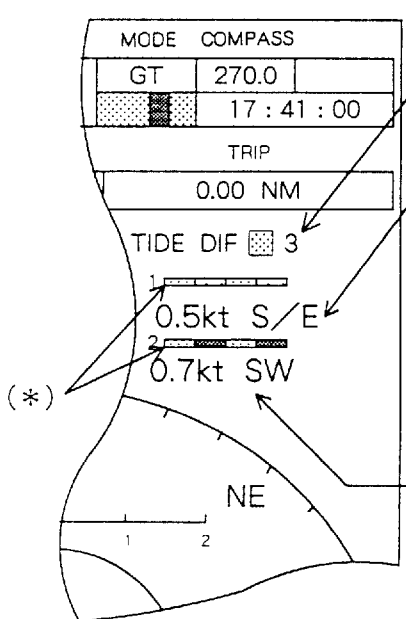

- ① Reference layer number
(See page 3-3 to set reference layer.)
- ② Tide differential between reference layer and shallower of the other two layers.
- ③ Tide differential between reference layer and deeper of the other two layers.

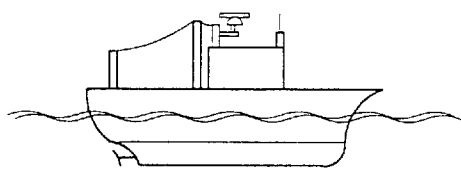

(Ex.) Ref layer = #3

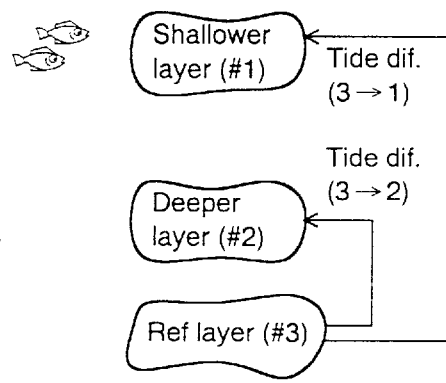

(*) Colors in bar correspond to layers used for tide differential measurement.

TIDE VECTOR Display

- o Each tide vector can be switched on and off independently by MENU 1 – “LAYER n” setting. (Refer to page 3-3.)
- o Tide differential vectors can be switched on and off by MENU 1 – “TIDE DIF DISP” setting. (Refer to page 3-3.)
- o Each vector bar indicates “flowing to” own ship direction with the standard factory setting. It is possible to reverse the pointing direction to “flowing from.” (Refer to page 5-1.)

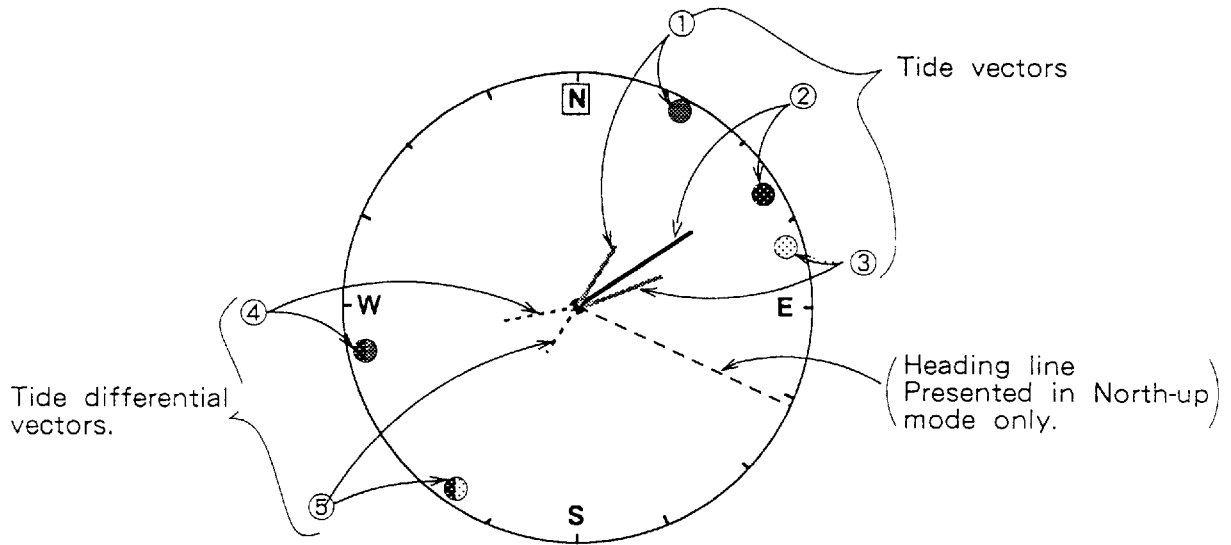

Note : If vector bars of two or more layers point in the same direction, only the vector bar and the direction mark of the shallowest layer appear.

	Ground Tracking Mode (See page 1-7/8.)	Water Tracking Mode (See page 1-7/8.)	Nav-aided Mode (See page 1-7/8.)
① (YEL)	Absolute tide movement of layer 1	Relative tide movement of layer 1 based on surface layer.	Absolute tide movement of layer 1 (nav-tide)
② (PPL)	Absolute tide movement of layer 2	Relative tide movement of layer 2 based on surface layer.	Absolute tide movement of layer 2 (nav-tide)
③ (L-BLU)	Absolute tide movement of layer 3	Relative tide movement of layer 3 based on surface layer.	Absolute tide movement of layer 3 (nav-tide)

④
⑤ Tide differentials between a specified reference layer and the other two layers.
(Ex. Ref. Layer = #2)

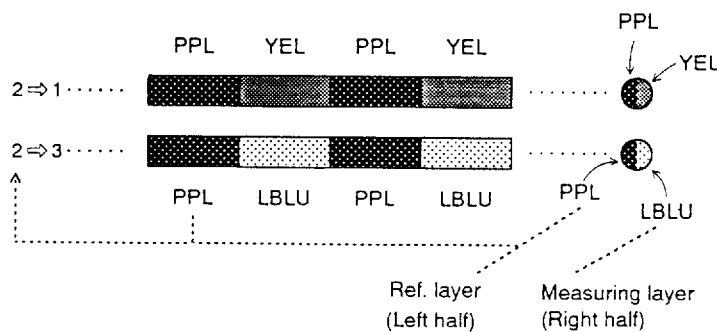

TIDE HISTORY Display

The CI-60G can hold last 24 tide samples collected at a time interval of 15 sec, 1 min, 5 min, 10 min, 30 min or 1 hour. The tide history presents variation of these tide information with a string of round marks. That is, distance from the graphic center to a mark represents tide speed at the sample time, and the direction from the center to a mark represents tide direction.

The figure below can be interpreted that the tide has changed from SW to NE (opposite) direction.

- To call the tide history display, press the **HISTORY** key. The tide history of layers activated in MENU 1 – “LAYER n” are displayed. (The figure below shows history of only one layer.)
- To restore normal tide vector display, press the **HISTORY** key again.

Tide history of layer 1
(last 24 samples)

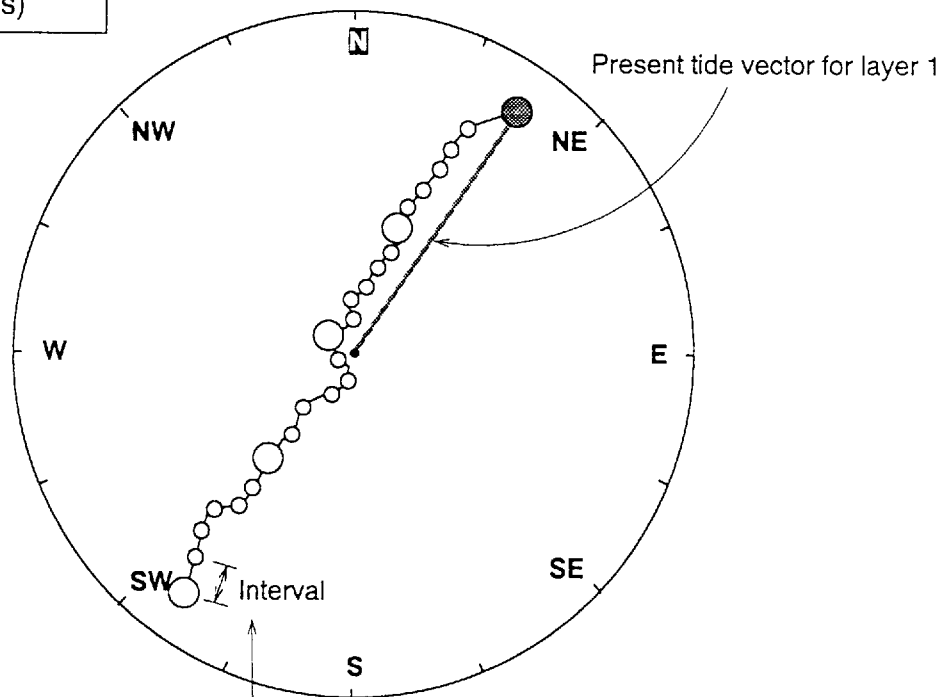

You can select sampling time interval of tide history in MENU 1.
(See page 3-3.)

Note: The CI-60G preserves the tide history data stored in the memory when the power is off.

COURSE PLOT Display

The course plot display provides ship's track of last 20 minutes (200 points, one point sampled every 6 seconds). Event positions, stored by the **EVENT** key, are also plotted with "+" marks.

- Press the **COURSE PLOT** key to call course plot display, and press the same key again to restore previous display.

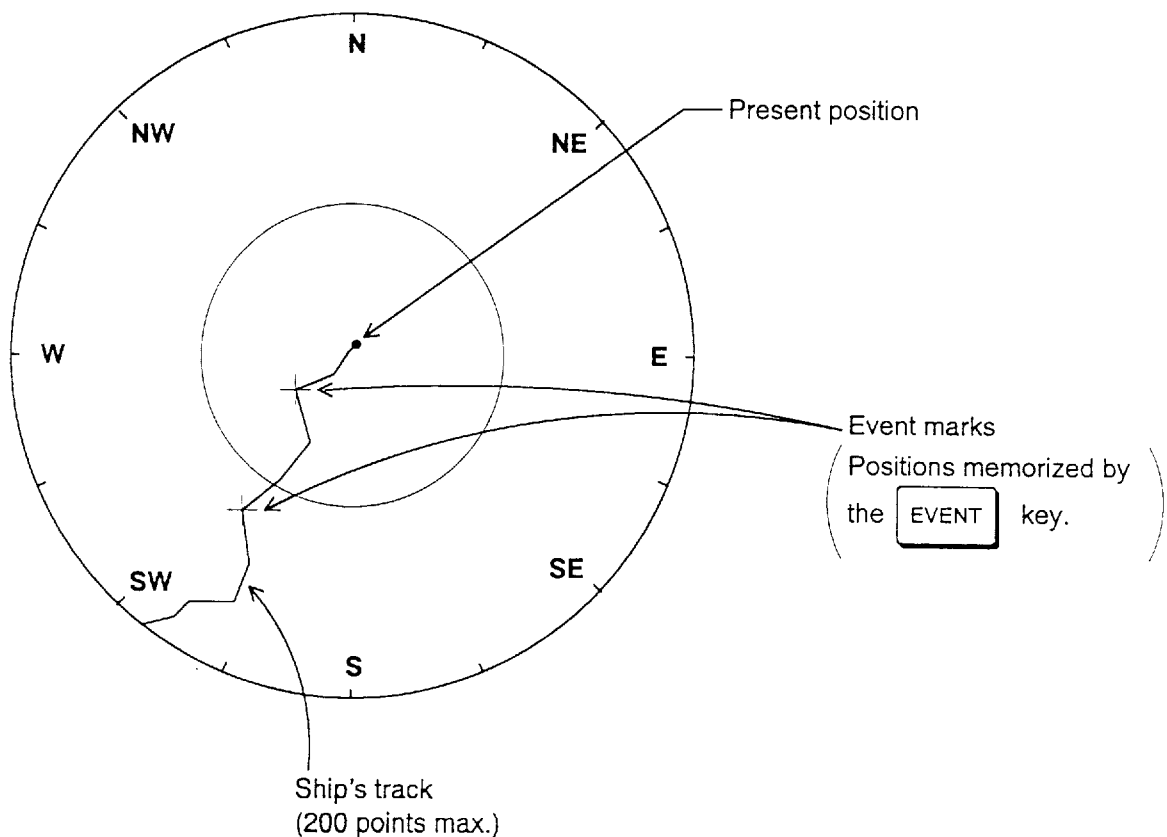

- To change display range (distance range) of course plot, press the **RANGE** key and set desired 'DIST RANGE' in the RANGE menu. (See page 3-7.)
- To clear event memory (marks), select 'ERASE' in MENU 1 – "EVENT" and then press the **EVENT** key.

Note:

- Capacity of ship's position memory (for course plotting) is limited to 200 points. When the position memory is fully occupied, the oldest position is erased as new one comes in.
- Position memory will be erased when the power is turned off.
- Sampling interval of ship's position is fixed to 6 seconds, and it can not be changed.

TIDE EFFECT Display

The tide effect display is useful for estimating three-dimensional deformation of cast net by the effect of tides at different depths. Notice that the display merely shows movements of layers; it does not show true net shape in the water.

Assume that you put drifting marks (virtual buoys) on the net at each layer below the vessel at an interval of six seconds.

As the marks move with the tides keeping the same speeds and directions, a series of marks makes a brief section shape of the net at the layer.

In practice, a net does not sink immediately, because of various tensions and stresses placed on it. Thus, use the tide effect information only as a reference.

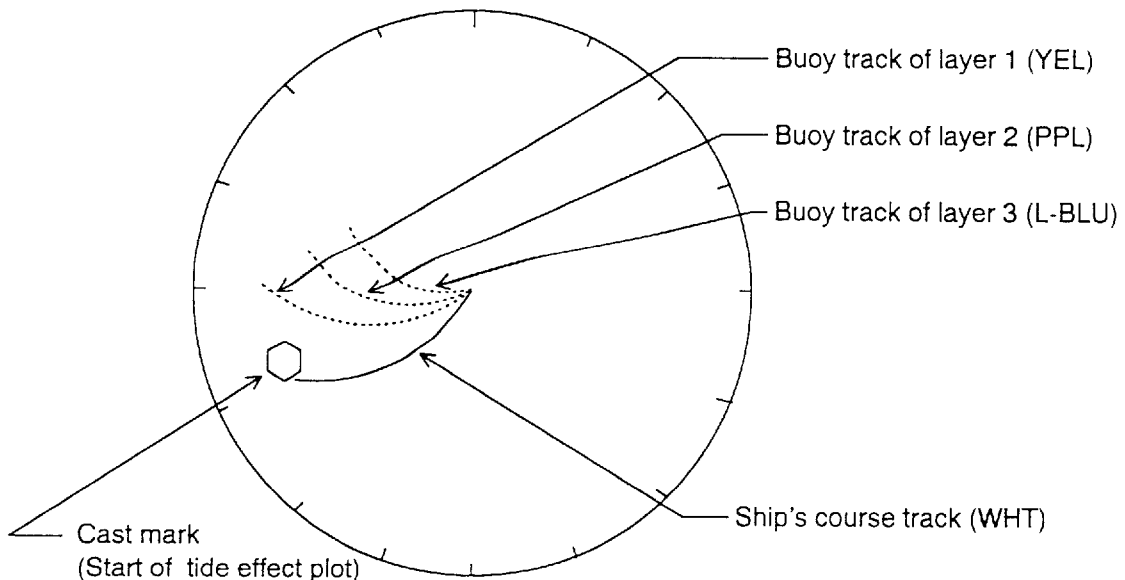
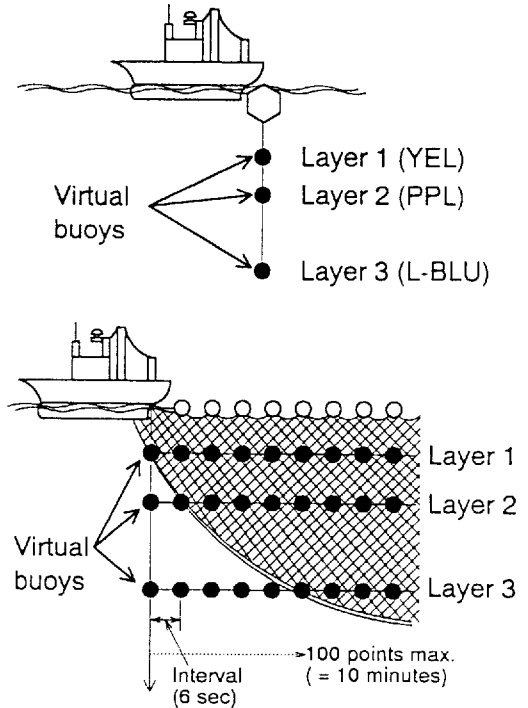

- To start "tide effect plotting", press the **TIDE EFFECT** key.
- To stop plotting and to clear traces, press the **TIDE EFFECT** key again.

Example of tide effect plotting

Display(Head-up)

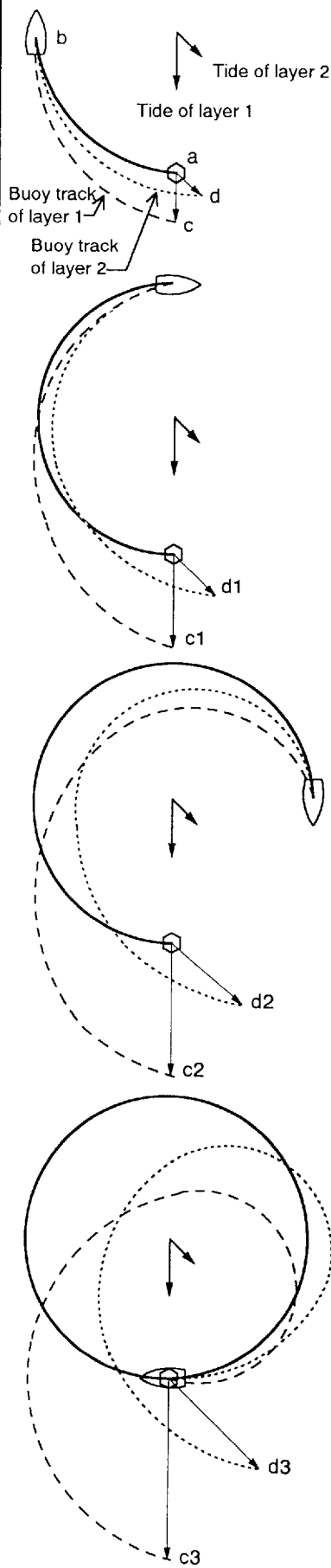

Casting the first virtual buoys at point "a", vessel made 1/4 of a circle and reached point "b".

Assume that each buoy moves on each layer keeping the same speed and direction as at time of measurement.

As time passes, the first buoys should move as follows:

- $c \rightarrow c1 \rightarrow c2 \rightarrow c3$:
(Layer 1)
- $d \rightarrow d1 \rightarrow d2 \rightarrow d3$:
(Layer 2)

If the above situation is presented in the head-up mode, the display will change as shown right.

If there is no tidal movement, the ship's course and the buoy tracks will coincide.

If all layers are moving at the same speed and direction, buoy tracks of all layers should coincide.

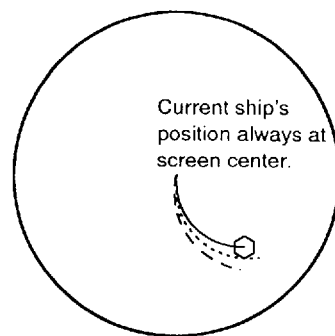

Current ship's position always at screen center.

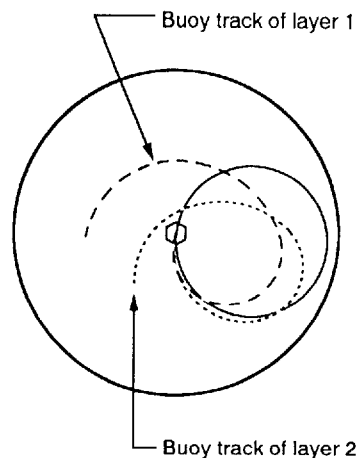
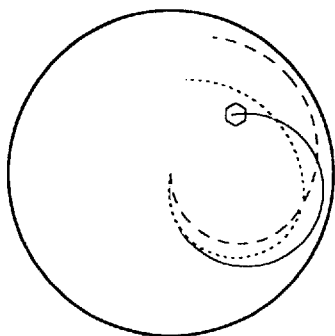
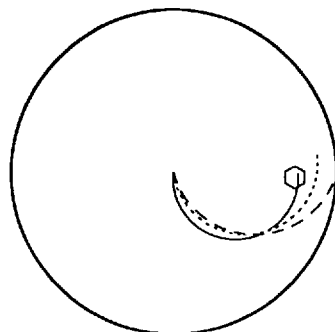

DRIFT Display (Switched on and off in MENU 1)

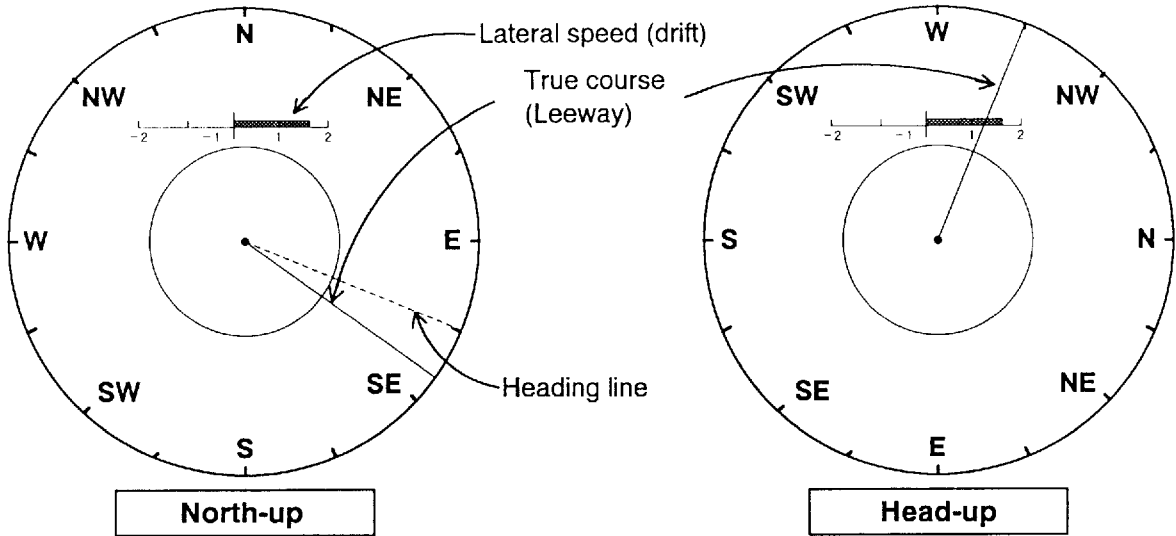

HEAD-UP/NORTH-UP Presentation

The  key switches between "HEAD-UP" mode and "NORTH-UP" mode.

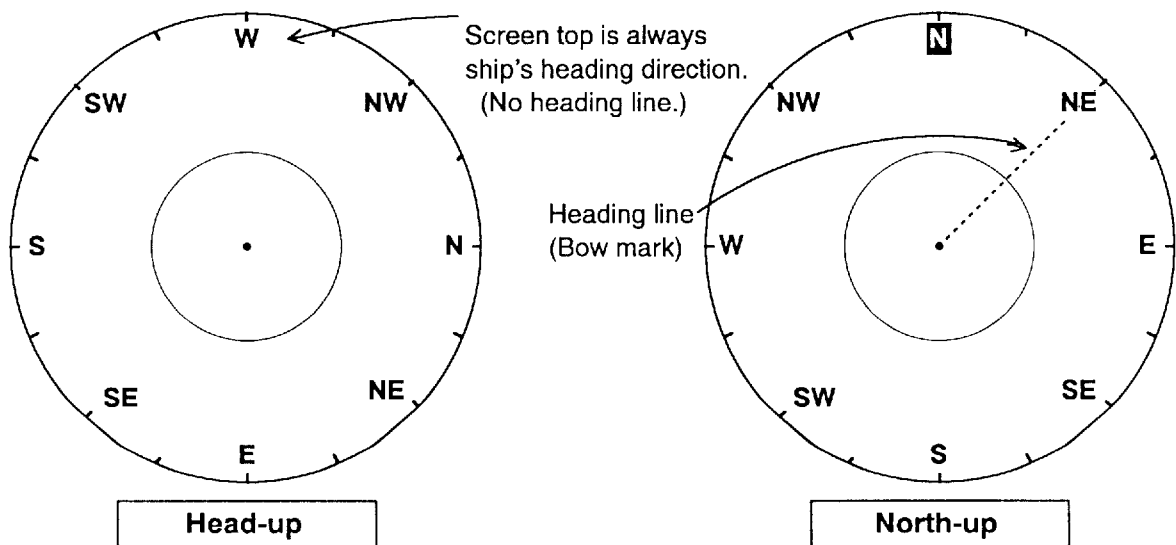

RANGE CURSOR (Variable Range Marker)

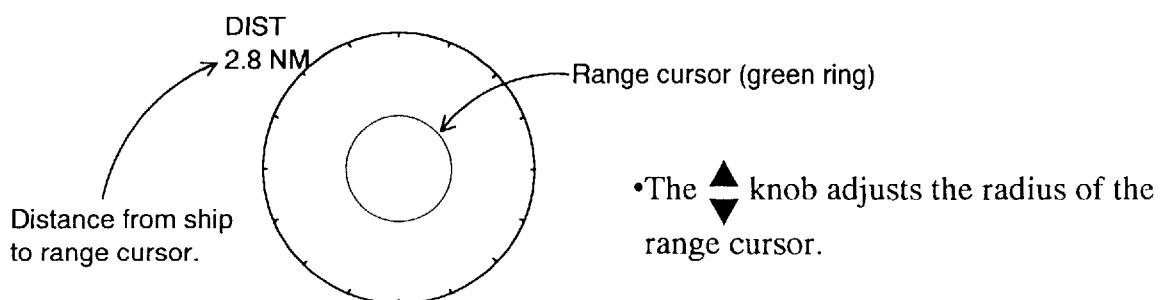

ECHO LEVEL Display (Display mode selectable in MENU 1)

Two presentation modes are available for echo level display.

- The “COLOR” mode provides narrow echograms for three directions, presenting echo strengths in color gradation. (Color sounder mode)
- The “GRAPH” mode presents echo strengths of three beams with amplitude varying with depth. (A-scope mode)

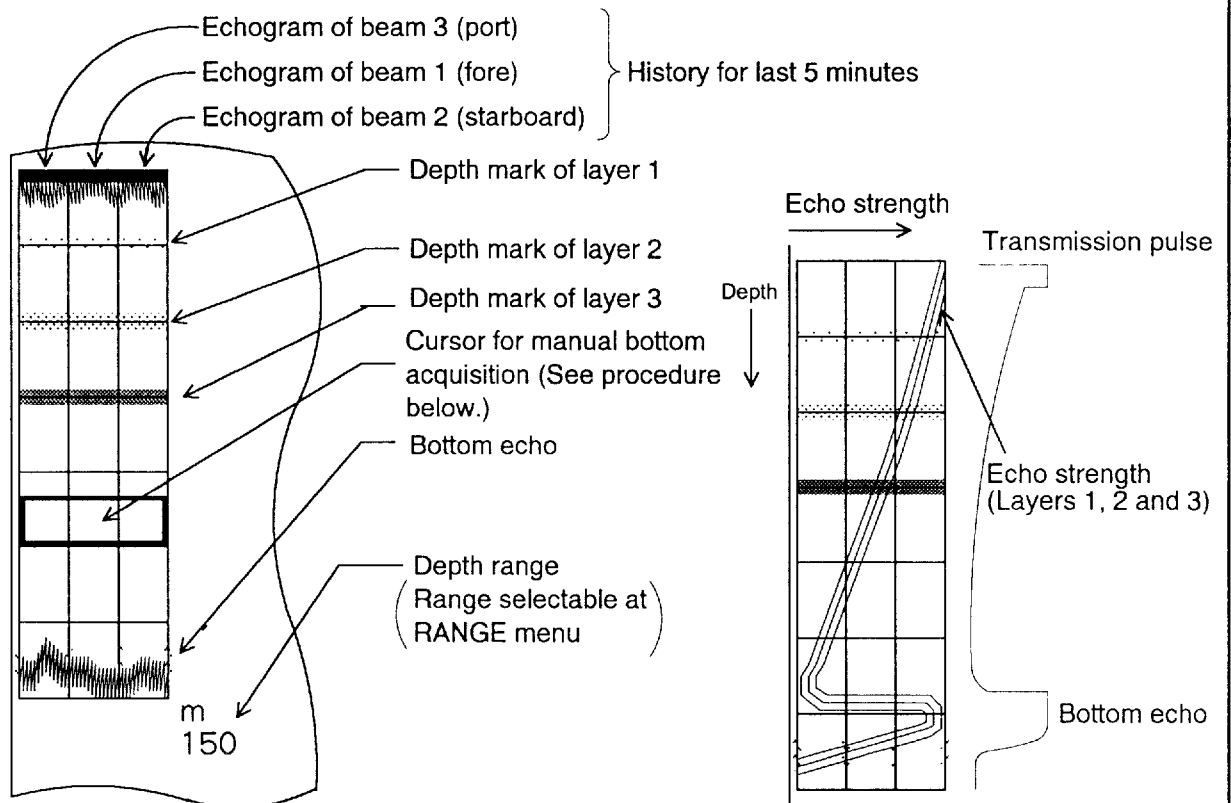

COLOR GRADATION mode
(Echo history for 5 minutes)

AMPLITUDE GRAPH mode
(Realtime A-scope)

- When bottom echo is lost for a short while due to air bubbles, or the equipment tends to track on false bottom, try to acquire it manually.
 1. Set “REF DEPTH” to OFF in MENU 2.
 2. Select ground tracking mode by the **TRACK MODE** key.
 3. Press the **MANUAL TRACK** key for more than 1 second. LED indicator aside the key lights and the manual tracking cursor appears in the echo level display.
 4. Turn ◀▶ knob to place the cursor on the bottom echo.
 5. When bottom echo is acquired, press the **MANUAL TRACK** key to return to the automatic ground tracking mode. (Do not leave the equipment in the manual tracking mode.)

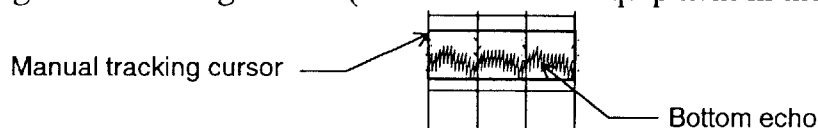

WATER TEMPERATURE Display

(Temperature data from external equipment required.)

- You can switch the temperature display on and off in MENU 1.

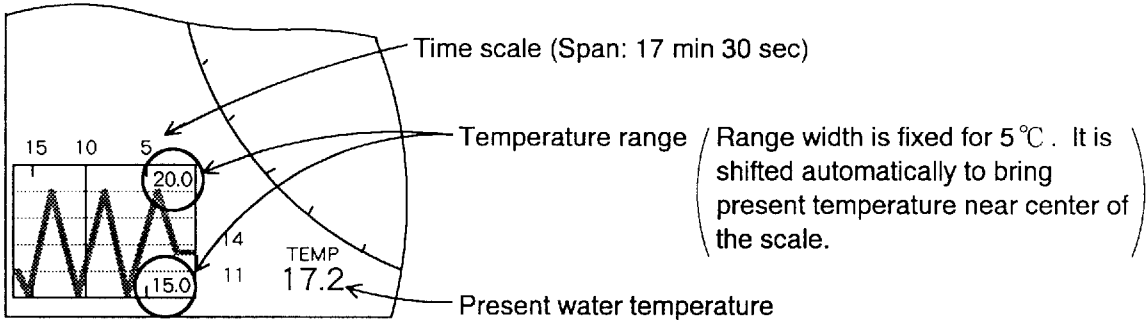

MISCELLANEOUS DATA Display

(Tide Averaging Time/Total Mileage/Display Range)

- You can change the unit of distance/range to km by an internal DIP switch. (See page 5-1.)

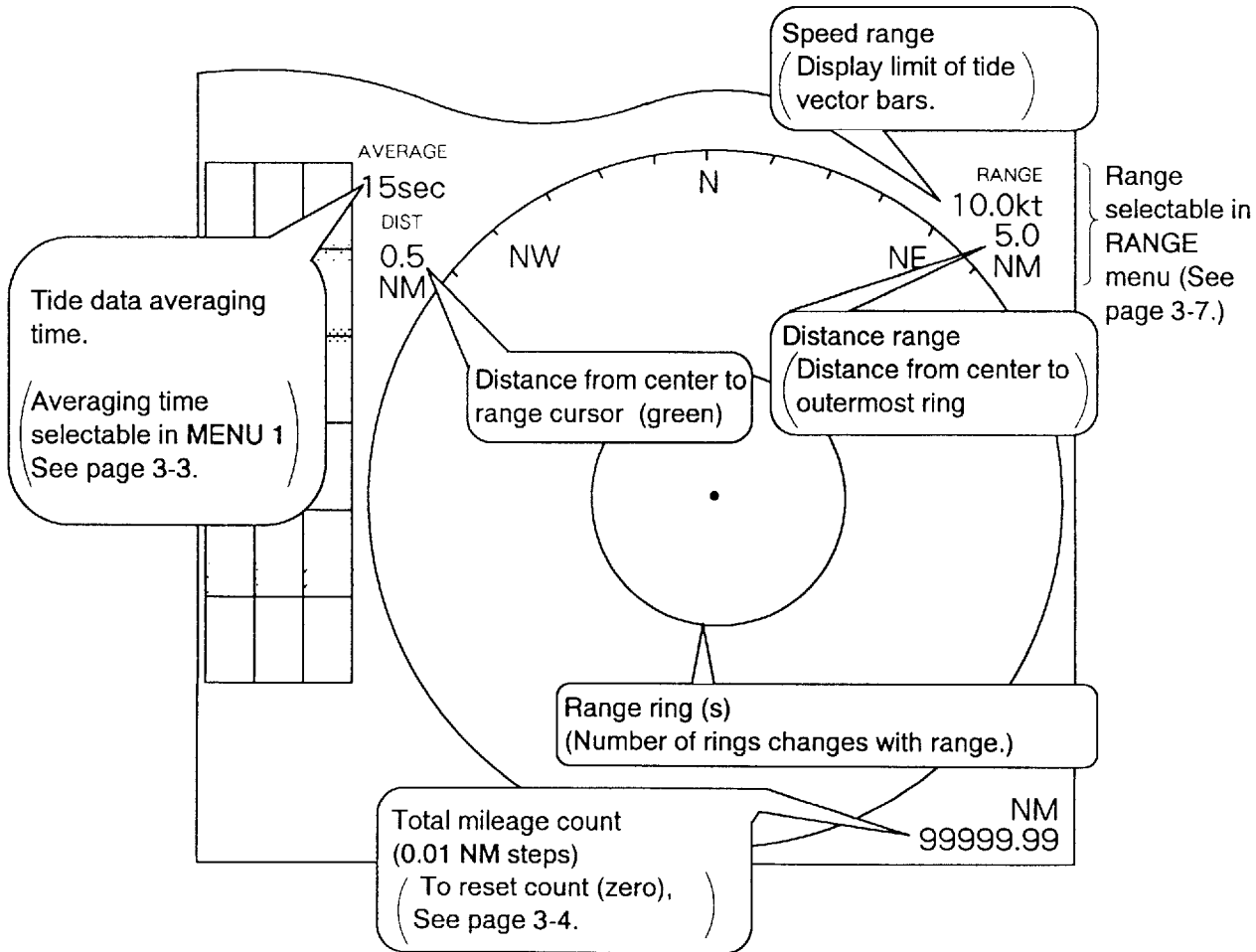

CHAPTER 2. OPERATION

1. CONTROL PANEL LAYOUT	2 – 2
2. FUNCTION OF KEYS & CONTROLS	2 – 3
3. OPERATING PROCEDURE	2 – 4

1. CONTROL PANEL LAYOUT

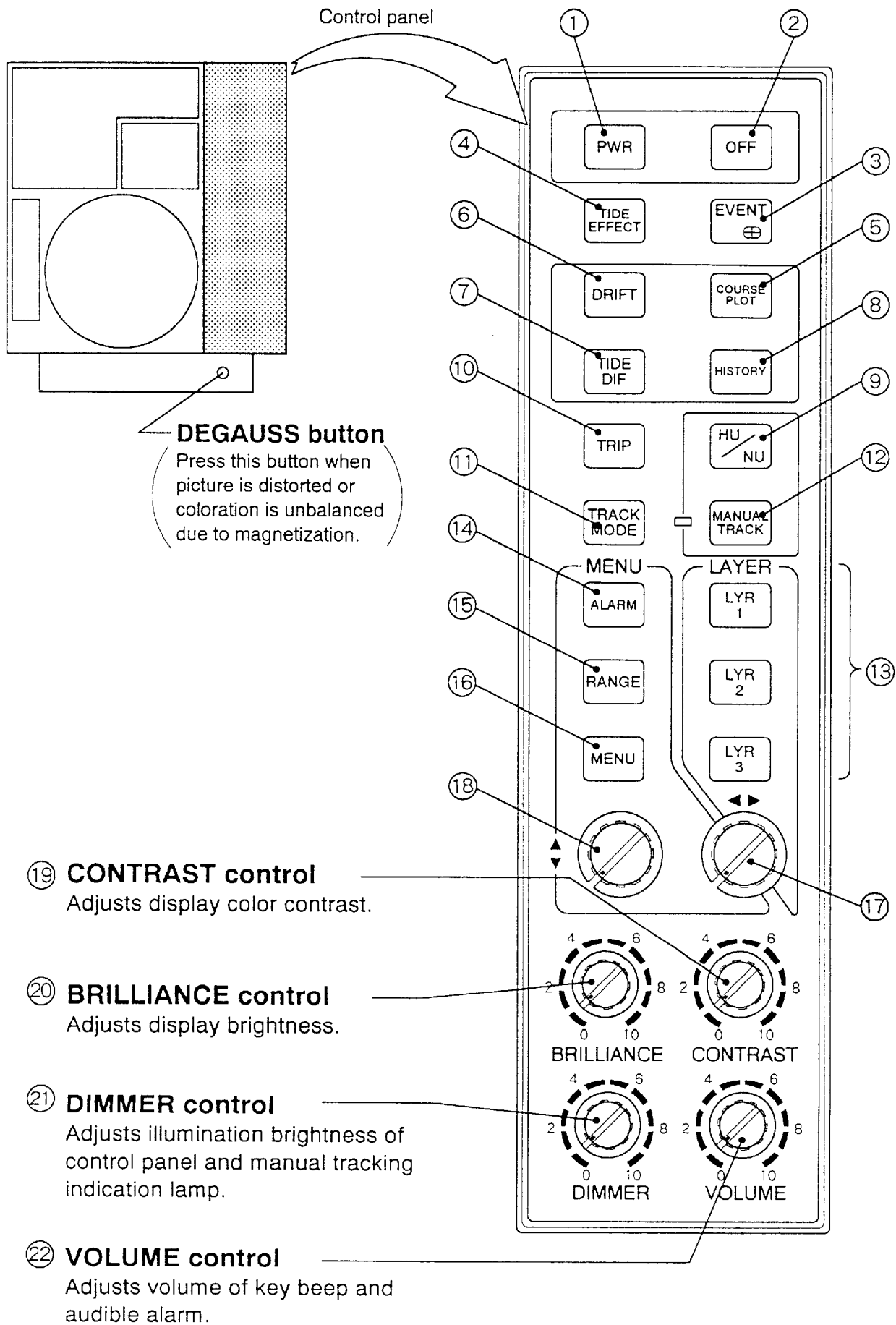



























2. FUNCTION OF KEYS AND CONTROLS

KEY	FUNCTION/OPERATION	REMARKS
① PWR	POWER ON :	
② OFF	POWER OFF : +	
③ EVENT	Plots event mark "+" at ship's present position. Event mark moves relatively as ship runs. Functions as "ENTER" key or "EXECUTE" key when menu window is open.	16 event marks maximum
④ TIDE EFFECT	Starts tide effect plotting. (A cast mark "○" is plotted at the start point.) Tide effect plotting shows movements of layers beneath ship's course track. To stop plotting and to clear traces, press this key again. (Once cleared, previous traces can not be recalled.)	
⑤ COURSE PLOT	Switches on and off the course plot display. (Even while the plot display is off, positions are sampled internally, and ship's course made of last 200 sampled points is called up instantly.)	
⑥ DRIFT	Presents set/drift information at upper-right section of the display.	Alternative selection
⑦ TIDE DIF	Presents tide difference information at upper-right section of the display.	
⑧ HISTORY	Pressing this key presents a tide history of last 24 sample points. (Only the histories of active layers appear.) History display is automatically cleared upon completion of a presentation sequence.	Sampling time interval of tide history can be selected at MENU 1.
⑨	Switches presentation mode of vector/course plot display between north-up and head-up. Heading line (white broken radial) appears when north-up mode is selected.	North-up modes requires external heading data.
⑩ TRIP	Clears and starts trip time or trip distance count.	To select trip time or trip distance display, set alarm distance limit or time limit at the ALARM menu.
⑪ TRACK MODE	Changes tracking mode cyclically. MENU 4-WT SPEED: "T/D" → → (*2) (*1) (*3) MENU 4-WT SPEED: "NAV-TIDE" → → (*2) (*1) (*3)	* 1: Select "T/D" or "NAV-TIDE" in MENU 4 - "WT SPEED" to switch between "WT" and "NAV" mode. * 2: "MAN" appears when tracking ground manually. * 3: "EXT" appears when taking external depth data as reference.

KEY	FUNCTION/OPERATION	REMARKS
⑫	Enables manual bottom acquisition in ground tracking mode. PREPARATION 1. In MENU 2, set "REF DEPTH" to "OFF." 2. Select ground tracking mode. MANUAL BOTTOM ACQUISITION 3. Press and hold key until LED lamp on the left of the key lights. (Mode display should change from "GT" to "MAN".) 4. Turn knob to place manual acquisition cursor () on the bottom echo in the echo level display. 5. Press key again when bottom echo is acquired.	At water tracking mode, water speed reference depth can be set to max. 256 m, by referring to gray depth cursor at echo display.
⑬ 	Selects tide measuring depth for the layer. NOTE: If "BTM TIDE TRK" is set to "ON" in MENU 3, the depth of layer 3 is automatically adjusted to near-bottom depth. ("BTM" appears instead of depth value.)	
⑭	Calls ALARM menu to set alarm conditions for various items. (• Tide speed/direction • Tide dif. speed/direction) (• Ship speed/bearing • Trip time/distance)	See page 3 - 8.
⑮	Calls RANGE menu to set range scales for various items. (• Vector speed range • Course plot distance range) (• Echo level depth range • Echo strength gradation range)	See page 3 - 7.
⑯	Calls basic MENU for various fundamental settings. (Sub-menus, MENU 1 thru MENU 4, are available.)	See page 3 - 2.
⑰	• Sets value or specifies mode option for a selected item in menu window. (Related to keys ⑫ to ⑯.) • Used to set ship's heading manually, when external heading data is not available. (See page 5-2.)	
⑱	• Selects an item in a menu window. (Related to keys ⑭ to ⑯.) • Adjusts radius of range cursor (variable range marker) on the vector display. Distance to the ring appears at the upper-left part of the vector display.	

3. OPERATING PROCEDURE

	SUBJECT/PURPOSE	OPERATION (ACTION)
1	Power-on	• Press  key.
2	Display brilliance adjustment	• Turn BRILLIANCE control. (CW : Bright, CCW : Dark)
3	Setting measuring depth	• Press  and turn  knob to set depth. After setting, press any key.
4	Selecting tracking mode	• Tap  key to select tracking mode. GT/WT/AUTO or GT/NAV/AUTO *Use ground tracking mode if water depth is shallower than 200m. *Select "T/D" or "NAV-TIDE" in MENU 4 – "WT SPEED" to switch between WT and NAV mode.
5	Reacquiring of temporarily lost ground echo (Manual bottom acquisition)	• Press and hold  key until "MAN" appears instead of "GT". (LED to the left of this key lights.) • While watching echo level display, turn  knob to place acquisition cursor on the bottom echo. • Press  key when bottom acquisition is completed.
6	Changing presentation mode for vector graph display	• Press  key to alternate "Head-up" mode and "North-up" mode.
7	Setting ranges • Speed range for tide vector display • Distance range for course plot display • Depth range for echo level display • Color gradation level for echo level display	• Press  key to call range menu. • Set desired range by  and  knobs. • Press  key again to store the setting.
8	Setting conditions for measurements and displays	• Press  key. • Set desired condition by  /  knobs and  key. • Press  key again to store the settings.
9	Setting alarm limits • Ships speed/course • Tide speed/direction • Tide dif. speed/direction • Trip time/distance	• Press  key to call alarm menu. • Set desired alarm conditions by  /  knobs and  key. • Press  key again to store the settings.
10	Plotting event mark (Storing present position)	• Press  key.
11	Starting and stopping tide effect plotting	• Press  key.
12	Switching course plot display on and off	• Press  key.
13	Power-off	• While pressing and holding down  key, press  key.

CHAPTER 3. SETTING OPERATING CONDITIONS (MENU WINDOWS)

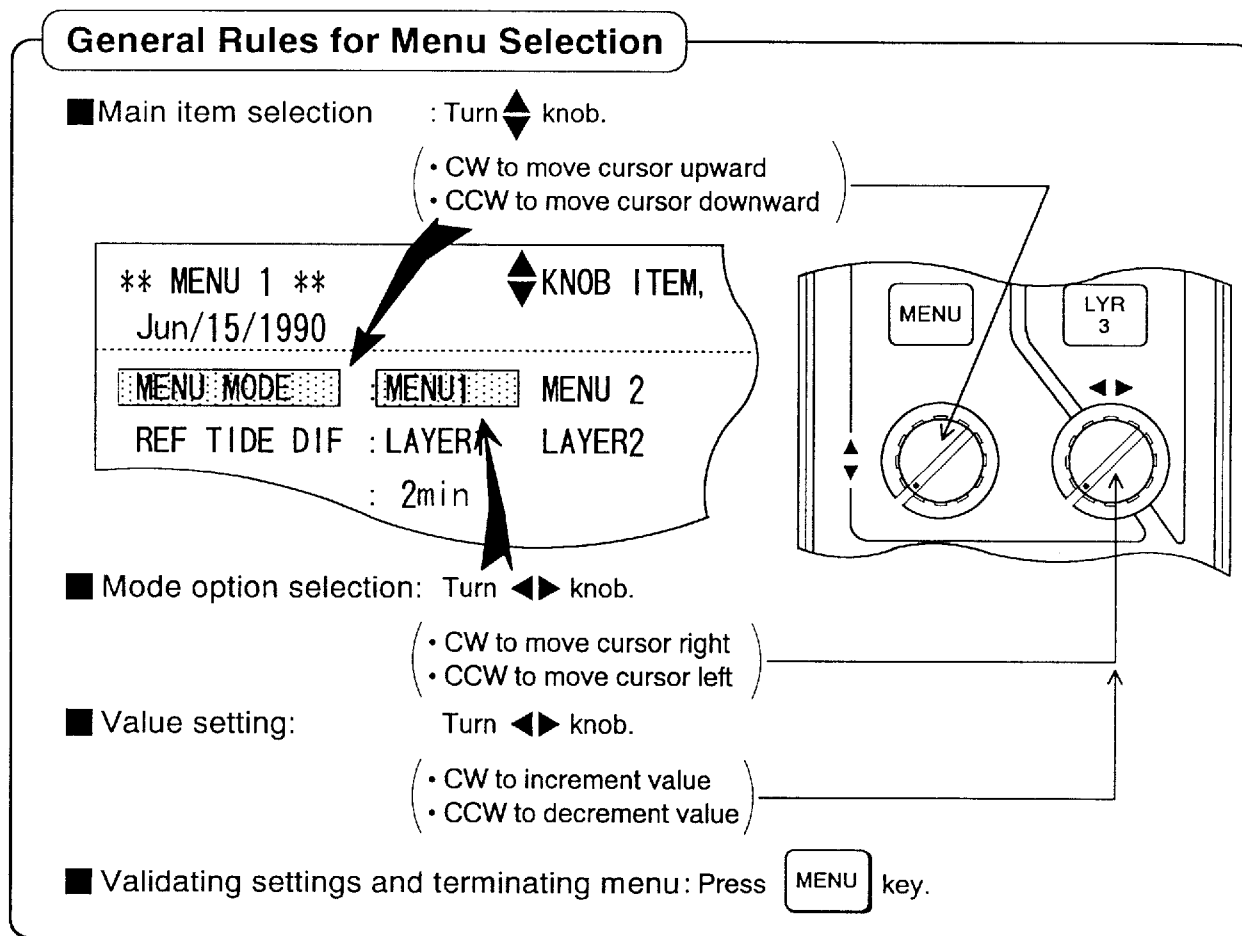

1. BASIC MENU	3 - 2
MENU 1	3 - 3
MENU 2	3 - 4
MENU 3	3 - 5
MENU 4	3 - 6
2. RANGE SET MENU	3 - 7
3. ALARM SET MENU	3 - 8

The CI-60G has three menus which you can preset various conditions for measurements and presentations; basic menu range menu and alarm menu.



1. BASIC MENU

Pressing the  key calls the basic menu window on the display. The basic menu contains four pages of menus called “MENU 1”, “MENU 2”, “MENU 3” and “MENU 4”. Important items in the menus appear in red to show that they are “locked” (protected) to prevent accidental change of settings.

To select another menu page in the basic menu, place cursor on “MENU MODE” – ‘MENU n’ by using  and  knobs.

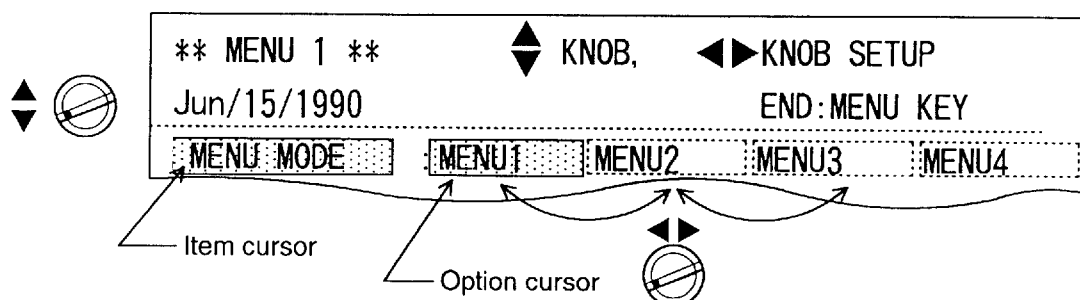

MENU 1

** MENU 1 **		◆ KNOB ITEM	◀▶ KNOB SETUP	
Jun/15/1991		END: MENU KEY		
MENU MODE		MENU1	MENU2	MENU3 MENU4
REF TIDE DIF		LAYER	LAYER2	LAYER3
(Note1)	TIDE AVERAGE	: 2	-----	
	TIDE HISTORY	: 15 sec	-----	
(Note2)	LAYER1	ON	OFF	-----
	LAYER2	ON	OFF	-----
	LAYER3	ON	OFF	-----
	TIDE DIF DSP	ON	OFF	-----
	DRIFT DSP	DRIFT	SPEED	OFF
	EVENT	: ERASE (0)	-----	
	TEMP DSP	: ON	OFF	-----
(Note3)	ECHO LEV DSP	COLOR	GRAPH	-----
(Note4)	BACKGROUND	NORMAL	1	2 3

◆ Knob ▶ Knob

Press **MENU** key to store the settings and to erase the menu window.

Reference layer for tide differential measurements

Averaging time for tide display (0 to 5 min in 1 min steps)

Tide history sampling time interval (15 sec, 1 min, 5 min, 10 min, 30 min or 1 hour)
Tide data of last 24 samples are kept in memory.

Tide vector display on/off switch for each layer

Tide differential vector display on/off switch

On/Off switches for drift scale display and ship's speed vector display in the vector graph section

To clear all event points (and marks), place cursor on "ERASE" and press **EVENT** key.
(Number in parentheses indicates number of event points stored.)

Presentation mode of echo level display
"COLOR" : Color sounder mode (echo strengths in color gradation)
"GRAPH" : A-scope mode (echo strength in amplitude varying with depth)

Background color (Select according to local lighting conditions.)
"NORMAL" : Darkgreen "1" : Darkblue "2" : Gray "3" : Darkgray.

NOTE 1 * Raw tide data is obtainable every 3 sec. Tide averaging time of "1 min" means that averaged data for last one minute is displayed.

The oldest data is discarded. 1 min : Average data for this period is displayed.

(Note) Averaging time of "0 min" does not mean immediate display of raw data but average of 15 seconds.

NOTE 3 ECHO Level Presentation Mode.

Beam 1 (Fore) Beam 2 (Stbd-aft) Beam 3 (Port-aft)

Depth Echo strength TX pulse bottom echo

COLOR GRADATION (Color sounder) **AMPLITUDE GRAPH (A-scope)**

If a setting absolutely must be changed follow the procedure below. Be ware, however, that needless change may seriously affect performance.

- Place vertical cursor on a locked (protected) item by ◆ knob.
- Turn ▶ knob clockwise by one step. The following message appears.

MENU SELECT IS LOCKED ▶ TO UNLOCK
 UNLOCKED NO YES
 PRESS EVEN KEY TO ENTER.
- Turn ▶ knob clockwise by one click to select "YES", and then press the **EVENT** key.
- Place horizontal cursor on desired option by ▶ knob.

You can unlock all protected items. For details see the next page.

NOTE 2 If tide vector display of a layer is switched off, the colored block circumscribing that layer number (in the fundamental data section) extinguishes.

NOTE 4 Menu items displayed in red (e.g., BACKGROUND) indicate they are protected against accidental change of setting.

MENU 2 (NOTE 1)

```

** MENU 2 **
Jun/15/1991
MENU MODE : MENU1 MENU2 MENU3 MENU4
REF DEPTH : OFF E/S
BEAM TEST : OFF
SELF CHECK : SINGLE CONT1 PANEL ECHO
DEMO DATA : OFF DP3.4 LOG10
TRIP RESET : RESET (0.00)
DATE/TIME : TIME DATE
MENU SELECT : LOCK UNLOCK
MENU SET : FACTORY
    
```

Press **MENU** key to store the settings and to close the menu window.

Selection of reference depth data source for bottom search in ground tracking mode
 "OFF": internal "E/S": depth data from external echo sounder

Shows beam number(s) being tested.
 "OFF" : Test off (normal operation) "F1" : Testing beam 1
 "F12" : Testing beams 1 and 2 "F13" : Testing beams 1 and 3
 "F23" : Testing beams 2 and 3

Test method and test item selection switch (See page 4-2.)

Simulation data selection for demonstration
 "OFF" for normal operation (See note 3 below.)

Clear (zero) the total mileage count. (Value in parentheses shows total mileage.)

Calls time set or date set sub-window.

Lock/unlock switch for all the protected preset items shown in red letters.

Restore factory settings.

◆ Knob

◆ Knob

NOTE 1 Menu items shown in red are (protected (or locked) to prevent accidental change of setting.

To change the setting of a protected item, follow the procedure below.

- Place the vertical cursor on the item by using **◆** knob, and then turn **◆** knob clockwise by one step. The following message appears.

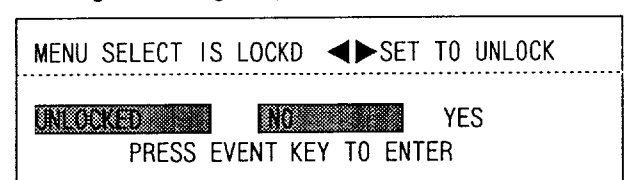

- Turn **◆** knob clockwise by one step to select "YES", and then press the **EVENT** key.
- Place the horizontal cursor on desired position, and press the **EVENT** key. There is no option item for "TRIP PRESET" and "MENU SET". Do not turn knob, but press the **EVENT** key immediately.

To unlock all protected items, place the cursor on **MENU SELECT UNLOCK**. Change of any protected item setting must be done with the greatest of caution, otherwise measuring accuracy may be degraded.

DATE/TIME settings

- By using **◆** knob, place the vertical cursor onto "DATE/TIME", and then turn **◆** knob clockwise by one step. When you see the alert message window, turn **◆** knob clockwise by one step again to select "YES". Press **EVENT** key to proceed to data/time setting sequence.
- Place the horizontal cursor onto "TIME", and then hit the **EVENT** key. The "TIME SET" sub-window should appear as shown below.

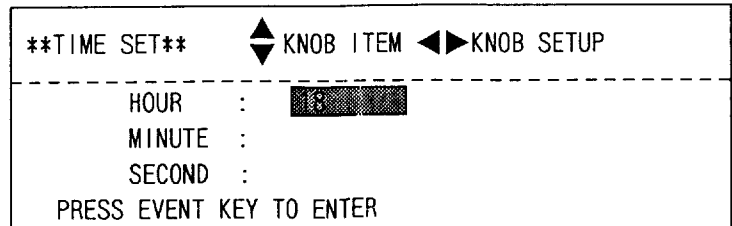

- Select HOUR, MINUTE and SECOND by **◆** knob, and at each, turn **◆** knob to set correct value. (Set a time 10 to 30 seconds ahead of actual time so you can press the **EVENT** key at the tone of a time signal.)
- Place the horizontal cursor to "DATE", and then press the **EVENT** key. The "DATE SET" sub-window appears. Set "YEAR", "MONTH" and "DAY" with the arrow knobs.

NOTE 2 REF DEPTH selection

Used to select reference depth data source for searching bottom echo in ground tracking mode.

"OFF": Bottom search by its own sounding (internal)

"E/S" : Bottom search by using depth data from external echo sounder as a reference.
 Tracking mode ID will be "EXT" instead of "GT".

If external depth data is not available, despite the selection of "E/S", an alert message appear on the bottom part of the display. (Error number 103)

NOTE 3 DEMO DATA selection

Used to check the equipment or to enable the demonstration by simulation signals generated internally.

"DP3.4"

	3.4 kt	N/E 10°
1	3.4 kt	N/E 10°
2	3.4 kt	N/E 10°
3	3.4 kt	N/E 10°

"LOG10"

	10.0 kt	N 0°
--	---------	------

MENU 3 (NOTE 1)

* MENU 3 *		◆ KNOB ITEM	◀▶ KNOB SETUP
Jun/15/1991		END : MENU KEY	
MENU MODE : MENU1		MENU2	MENU3 MENU4
SHIP SPD AVR	: 15sec		
DRAFT	: 0.0 m		
(Note 7) WT SPD DEPTH	: 2.0 m		
(Note 2) HEEL ANGLE	: 0.0 °		
(Note 3) TRIM ANGLE	: 0.0 °		
GT SPD CALIB	: 0.0 %		
WT SPD CALIB	: 0.0 %		
(Note 4) BEARNG CALIB	: 0.0 °		
(Note 6) COURSE CALIB	: 0.0 ° (GT 0.0 °) (NAV 0.0 °)		
EXT KP1 DIST	: 0.0 m		
EXT KP2 DIST	: 0.0 m		
(Note 5) BTM TIDE TRK	: OFF ON		

- Press **MENU** key to store (validate) the settings and to close the menu window.
- Averaging time for ship speed/course display (15/30/60/90 sec)
- Draft level; i.e., depth of transducer from sea surface (0.0 to 25.6 m)
- Reference depth to measure ship's speed in water tracking mode (2.0 to 25.6 m)
- Lateral (port-starboard) inclination angle (- 12.8 to +12.7°)
 "- " : starboard-high "+ " : port-high
- Fore-aft inclination angle (- 12.8 to +12.7°)
 "- " : aft-high "+ " : fore-high
- Ship speed offset in ground tracking mode
- Ship speed offset in water tracking mode
- Bearing offset angle of transducer (- 12.8 to +12.7°)
 "- " : transducer's fore-aft axis deviated to port
 "+ " : transducer's fore-aft axis deviated to starboard
- Offset angle to align course by CI-60G and course by external naviator [GPS] (- 12.8 to +12.7°)
 (GTx.x and NAVx.x are offset angles calculated by "CRS CALIB EXEC" operation in MENU 4.)
- Distance between transducers of CI-60G and other sounding device which is connected to the CI-60G as interfering source 1. (KP1)
- Distance between transducers of CI-60G and other sounding device which is connected as interfering source 2. (KP2)
- Used to select depth setting of layer 3.
 "OFF" : Manual setting
 "ON" : Automatic tracking on near-bottom tide

(Note 7) —
 (Note 2) —
 (Note 3) —
 (Note 4) —
 (Note 6) —
 (Note 5) —



NOTE 1 All the items in MENU 3, except "MENU MODE", appear in red to show that they are protected (or "LOCKED") items.

- To unlock an item;
1. First, place the vertical cursor on the desired item by **◆** knob, and then rotate **◀▶** knob clockwise by one step. The following appears on the display.

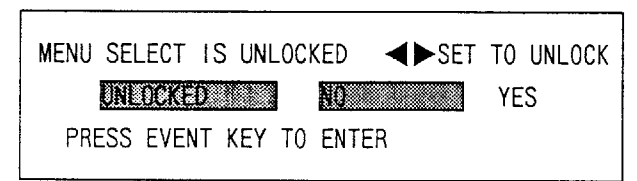

2. Turn **◀▶** knob clockwise by one step to select "YES", and hit the **EVENT** key.
3. Protected item is now unlocked. Turn **◀▶** knob to set desired value or option. Press the **EVENT** key to store new setting(s).

As noted on page 3-4 you can unlock all protected items. Beware, however, that change of setting may adversely affect equipment performance. Caution before changing any setting.

NOTE 2 HEEL ANGLE

Enter minus value if the boat (and transducer face) is inclined to port side.

NOTE 4 BEARING CALIB

Enter minus value if transducer's fore-aft axis is oriented to port side of ship's bow.

NOTE 3 TRIM ANGLE

Enter minus value if the boat (and transducer face) is inclined to fore side.

NOTE 5 BOTTOM TIDE TRACKING

In the ON position, measuring depth of layer 3 changes automatically with the bottom depth to track on near-bottom tide.

If it is "OFF", normal selection of measuring depth is attainable for the layer 3.

NOTE 6 COURSE CALIB

If course indication by ground tracking mode differs from that of navigator (GPS) even with a correct bearing calibration, enter the course calibration angle.

If course indication by CI-60G is deviated to clockwise direction, enter calibration angle with minus sign.

- * Course calibration angle entered here will be in effect only when "CRS CAL MODE" is set to MAN in MENU 4.
- * The way to automatically calculate and enter calibration angle is provided in MENU 4. (See "CRS CAL EXEC" on the next page.)

Note 7: By using the Manual Track key, water speed reference depth can be set to max. 256 m.

2. RANGE SET MENU

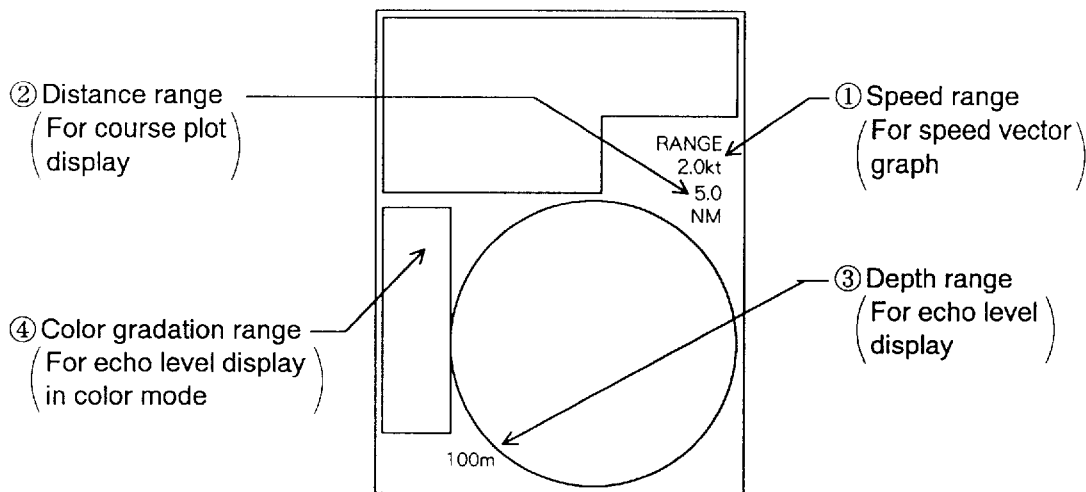

1. To change one of the above ranges, call the RANGE SET menu by pressing the



****RANGE SET**** **◆ KNOB ITEM, ◀▶ KNOB**

END : RANGE

SPEED RANGE : 10.0 kt ←

DIST RANGE : 1.0 NM ←

ECHO DEPTH : 150 m ←

ECHO SHIFT : 1 ←

(Note 1)

◆ knob

◀▶ knob

(*) Changes the threshold levels for coloring echoes with different strengths. (The higher the value, the lower the thresholds, and vice versa.)

A gradation factor of 1 to 7 is recommended. The higher (lower) the value, the greater the amount of red (blue) in echoes.

Notice that the threshold shift does not change the receiver gain nor performance of the equipment, although it changes echo color.

① Max. speed range of tide/tide differential vector display (1.0 to 20.0 kt in 0.1 kt steps)

② Distance from center (ship's position) to outermost ring (for course plot display) (0.5 to 5.0 nm in 0.5 nm steps)

③ Max. depth range for "echo level" display (50 to 400 meters in 50 meter steps)

④ Color gradation factor for "echo level" display (*) (1 to 36)

2. When desired range is set, press the



key again.

3. ALARM SET MENU

The ALARM menu permits selection of alarm sources and alarm parameters.

ALARM FOR TIDE/TIDE DIFFERENTIAL/SHIP'S MOVEMENT

This alarm is for alerting you to change in speed and direction of tide/tide dif./ship's movement .

- :Alarm range not set. (factory default)
- ☆ :Alarm range (zone) is preset, but alarm function is inactive.
- ★ :Alarm function is active.
- 🔊 :Audible alarm is disabled. (Speaker OFF)
- 🔊))) :Audible alarm is enabled. (Speaker ON)

****ALARM SET**** KNOB ITEM, KNOB SET TP

★ : ON ☆ : OFF EXEC : EVENT

1ST LAYER	:	SPD ☆	🔊)))	DIR ☆	🔊
2ND LAYER	:	SPD ☆	🔊)))	DIR ☆	🔊)))
3RD LAYER	:	SPD ☆	🔊)))	DIR ☆	🔊)))
(Note1) SHALLOW T/D	:	SPD ☆	🔊)))	DIR ☆	🔊)))
DEEP T/D	:	SPD ☆	🔊)))	DIR ☆	🔊)))
SHIP SPEED	:	SPD ☆	🔊)))	CRS ☆	🔊)))
TRIP	:	DIST ☆	🔊)))	TIME ☆	🔊)))

knob

knob





(Note 1)



SHALLOW T/D : Tide difference between base layer and the shallower of the other two layers.

DEEP T/D : Tide difference between base layer and the deeper of the other two layers.

REF. LAYER	SHALLOW T/D	DEEP T/D
1	1 → 2	1 → 3
2	2 → 1	2 → 3
3	3 → 1	3 → 2

ALARM setting procedure

1. Call “ALARM SET” menu by pressing the  key.
2. By the  knob, place the vertical cursor on the desired item; then select an option item by the  knob.
3. Press the  key. The subsequent action depends on the location of the horizontal cursor.

- 1) When the horizontal cursor is on a speaker mark, the  key functions to turn the audible alarm OFF “” or ON “.

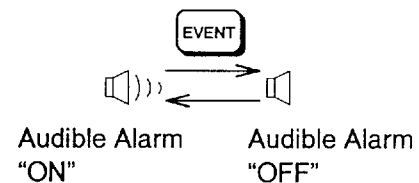

Note that the audible alarm sounds for the items with a filled star mark “★” beside them..

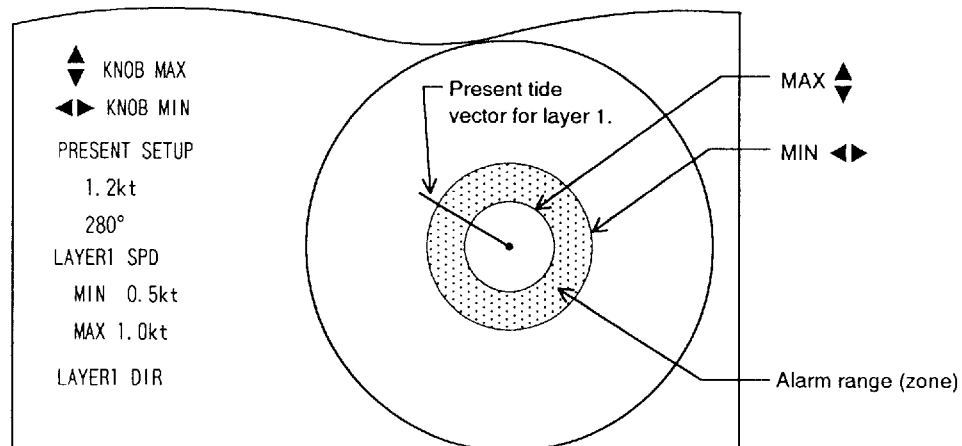

- 2) When the horizontal cursor is on an item which has the hollow star “☆” aside it or no star mark, the range set display appears.

Ex. Selected “LAYER1”- “SPD ☆”



As necessary, change alarm range (zone) by  knob (MAX) and  knob (MIN), and then press the  key. The hollow star “☆” changes to the filled star “★” to indicate the alarm setting is valid (or active).

- 3) When the horizontal cursor is on an item which has the filled star mark “★”, beside it, the following sub-menu appears.

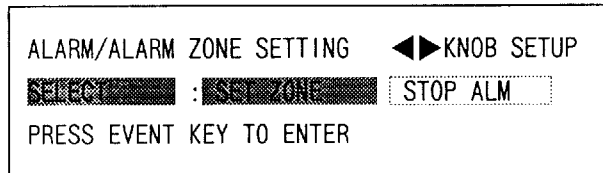

To make alarm setting valid;

- ① Place the horizontal cursor on “SET ZONE” by ◀▶ knob, and press the key. The alarm zone setting display appears.

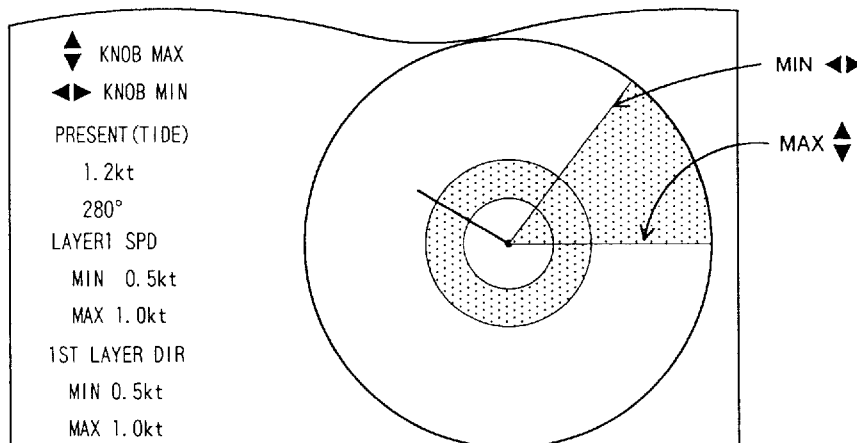

EX. Selected “1ST LAYER”- “DIR ★”



- ② As necessary, change alarm zone by ▲▼ (MAX) and ▶◀ (MIN), and then press the key.

To make alarm setting invalid;

- ① In the alert message window, select “STOP ALM” by ▶◀ knob, and press the key. The filled star “★” beside the option item changes to the hollow star “☆” to show the alarm setting is now invalid. (Alarm zone settings are preserved, but they do not trip the alarm.)

4. After entering the alarm/alarm zone, press the  key to store the settings and to close the alarm menu window.
5. When the conditions of an alarm are breached, with ship's movement or tide movement, the alarm message starts blinking at the bottom part of the display. If the audible alarm is enabled for that item, the alarm sounds.
 - To cease the audible alarm, call the alarm menu and disable (OFF) the audible alarm () → ), or make the alarm setting invalid (“★” → “☆”.)
 - To mute the audible alarm temporarily, turn the VOLUME control counter-clockwise.

Alarm Priority

Alarm priority is in the order as listed in the Alarm menu.

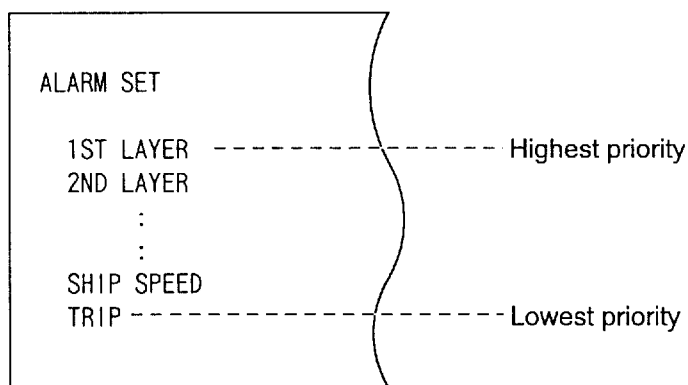

If multiple alarm conditions are violated, alarm having the highest priority is presented as a visual alarm at the bottom of the display.

There is no priority for the audible alarm; the alarm is released whenever an alarm parameter is violated.



ALARM FOR TRIP DISTANCE AND TRIP TIME



Two basic functions are included in the trip alarm facility:



- o Generates the alarm when preset trip time or trip distance is reached.
- o Measures distance-run for a certain preset period, or to count time-elapsed to run a certain preset distance.

Procedure



1. In the alarm menu, select “TRIP” item by the  knob.



- A. To set a distance limit, turn  knob for “DIST (☆)” option, and then hit the  key. The following sub-window appears.



```
**DISTANCE RUN ALARM**  KNOB ITEM.  KNOB SETUP
                                     EXEC : EVENT
TRIP DIST : 0.1 NM
```

Turn  knob to set a distance-run, and then hit the  key.

A filled star mark “★” appears aside “DIST” to show the distance alarm setting is valid.

To start counting distance, press the  key. Note that the alarm distance counting is performed internally but not shown on the display. When the preset alarm distance is reached, time-elapsed display becomes red and the counting is stopped. If the audible alarm is enabled (“”), it is released.

- B. To set a trip time alarm, turn  knob for “TIME ☆” options and hit the  key. The following sub-window appears.

```
**DISTANCE RUN ALARM**  KNOB ITEM.  KNOB SETUP
                                     EXEC : EVENT
TRIP TIME : 0 HOUR
           : 15 MINUTE
           : 0 SECOND
```

After selecting hour, minute and second by the \blacklozenge knob, set your desired trip time (alarm limit) by the $\blacktriangleleft\blacktriangleright$ knob. Then, press the **EVENT** key to store the setting. A filled star “★” appears aside “TIME” to show the trip time alarm setting is valid.

To start counting trip time, press the **TRIP** key. Note that the trip time counting is performed internally, but not shown on the display. Instead, distance-run in the TRIP display frame counts up.

When the preset trip time is reached, the distance-run display becomes red and the counting is stopped. If the audible alarm is enabled (“ \square ”)), it is released.

Example A. Trip distance : 1NM

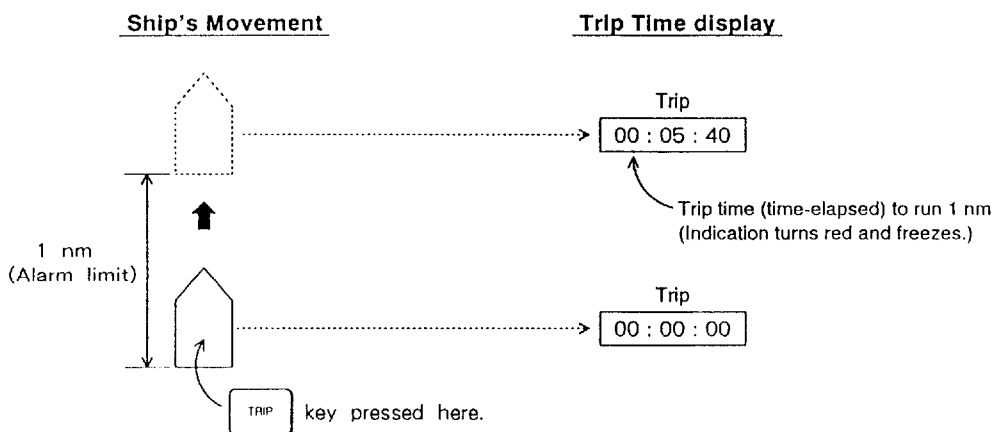

Example B. Trip time : 1 hour.

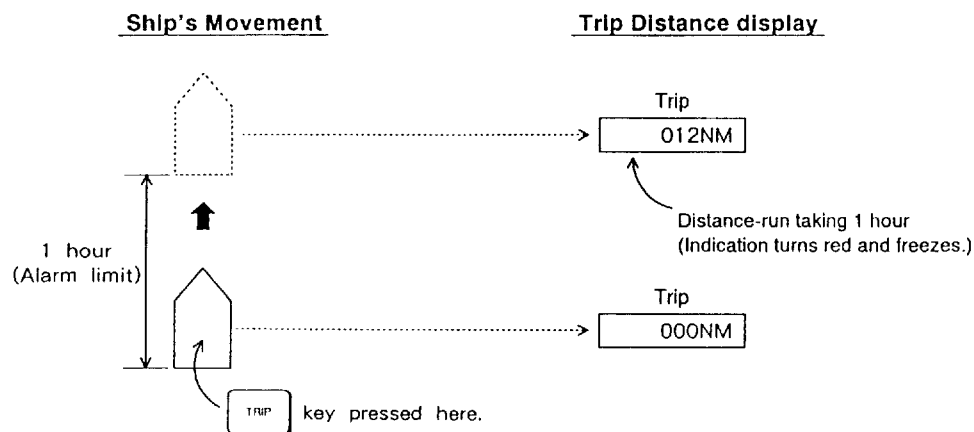

CHAPTER 4. TROUBLESHOOTING

- 1. SELF-CHECK 4 – 2
- 2. ERROR INDICATION 4 – 5



DANGER





Do not work inside the equipment unless totally familiar with electrical circuits.

Hazardous voltage which will cause death or serious injury exists inside the equipment.

1. SELF-CHECK

The CI-60G has a self-test facility for general diagnosis of its major circuits. If an unusual symptom is encountered during operation of the equipment, perform the self-check. If the self check reveals equipment fault, shown by the error code, report the results to the service technician when calling for service. (The user should not attempt further check inside the equipment.)

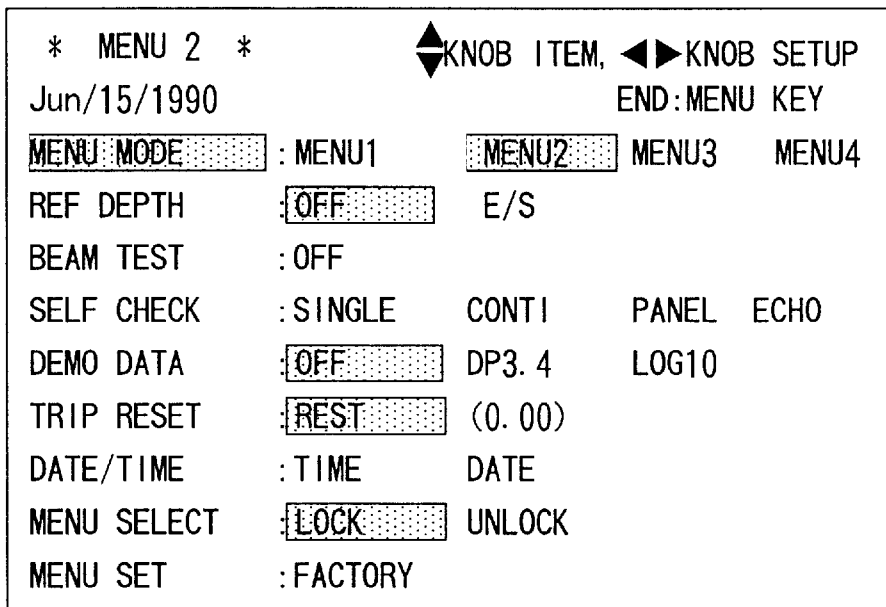

Procedure

1. Call menu window by pressing the **MENU** key.
2. Select "MENU MODE" – 'Menu 2' by the  and  knobs.

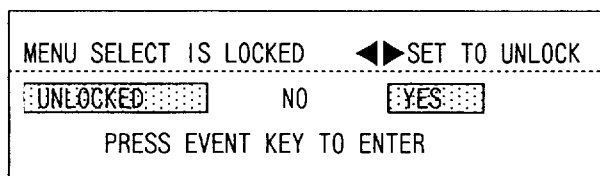

3. Place the item cursor on "SELF CHECK" by the  knob, and then press the **EVENT** key. As this item is protected (locked), the following alert appears.



4. Select 'YES' by the  knob and press the **EVENT** key. The color of "SELF CHECK" turns green to show the item is unlocked.
5. Select a check option, SINGLE, CONTI, PANEL or ECHO by the  key, and then press the **EVENT** key to start the self check.

SINGLE (single cycle)

The SINGLE test executes the system check for one cycle displaying the test result for each item checked. Items checked are ROM/RAM and P.C. boards for the Display unit and the Transceiver unit. Echo strengths from three transducers are also displayed in the ECHO LEVEL frame.

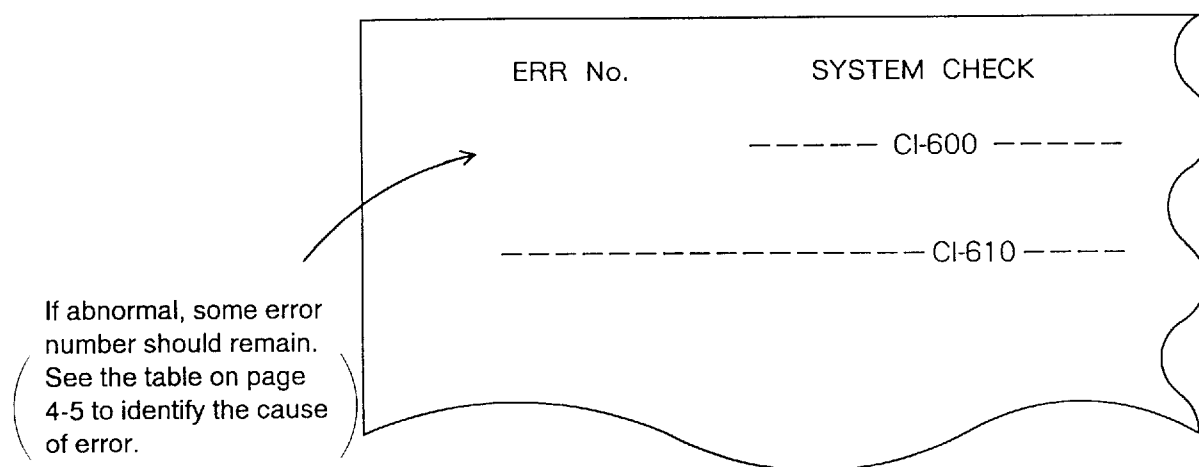

CONTI (continuous: repeat)



The CONTI test executes the system check repeatedly. To escape, press the **MENU** key.

PANEL

The PANEL test checks the front panel keys and controls for proper operation.

Press and release each key to see if it is making (1) and breaking (0) correctly. Also, turn **◆** and **◀▶** knobs to see if the step count changes from 0 to 63. (CW : count up, CCW : count down)



To terminate the PANEL test press the **MENU** key.

PANEL TEST			
TIDE EFT	0	0	EVENT
DRIFT	0	0	CRS PLOT
TIDE DIF	0	0	HISTORY
TRIP	0	0	HU/NU
MODE	0	0	MAN TRK
ALARM	0	0	LAYER 1
RANGE	0	0	LAYER 2
MENU	0	0	LAYER 3
VR	[]	VR	[]
	0		4
END:MENU KEY			

ECHO

The ECHO test displays echograms for three transducer beams. This lets the service technician check the transmitter/receiver for proper operation.

The following key and knobs function to change receiving conditions.

KEY/KNOB	FUNCTION
	TVG setting ON/OFF
	Depth range selection
	Echo strength (receiver gain)

To terminate the 'ECHO' check, press the  key.
 (The CI-60G restarts in the same condition as if it is switched on.)

2. ERROR INDICATION

If the unit detects abnormal operation in the transceiver unit it displays a (blinking) message and a three-digit error code and releases the audible alarm. (Error indication will not interrupt the operation of the equipment.)

The error codes and the corresponding status are tabulated below. If multiple items are in error; only the latest error code appears.

ERROR CODE	ERROR STATUS (CHECK ITEM)
000	Abnormal main's input voltage
001	Overheated transducer
002	Abnormal TX high voltage (+B)
003	Abnormal TX voltage for beam 1
004	Abnormal TX voltage for beam 2
005	Abnormal TX voltage for beam 3
006	Abnormal TX current for beam 1
007	Abnormal TX current for beam 2
008	Abnormal TX current for beam 3
100	External position data is missing despite "WT SPEED" is NAV-TIDE and "NAV DATA" is L/L in MENU 4.
101	External speed data is missing despite "WT SPEED" is NAV-TIDE and "NAV DATA" is SPD in MENU 4.
102	External time data is missing despite "TIME DATA" is set to EXT in MENU 4.
103	External depth data missing despite "REF DEPTH" is set to E/S in MENU 2.
104	External heading data missing
105	External bearing (course) data differs from internal absolute bearing by more than 5°
106	External water temperature data missing
200	External keying pulse irregular
201	Abnormal temperature sensor input
202	Abnormal "roll" signal from inclinometer
203	Abnormal "pitch" signal from inclinometer

CHAPTER 5. DIP SWITCH SETTINGS

The CI-60G permits customizing some of its characteristics to suit operator's preferences or to set up for a particular system configuration.

Change the DIP switch setting depending on the operator's preference. (S1 on the display ICP board)

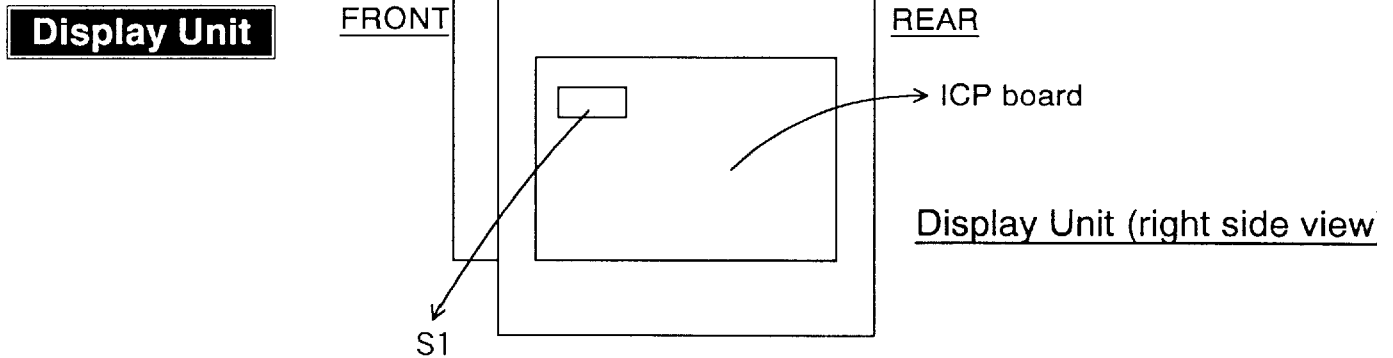

SEG. No.	FACTORY SETTING		FUNCTION
	ON	OFF	
1		○	[Bearing/course notation] ····· (* 1) ON: degree in large letters OFF: 32-point in large letters
2		○	[Unit of distance/range] ON: KM OFF: NM
3		○	[Vector pointing direction] ON: direction flowing <u>from</u> OFF: direction flowing <u>to</u>
4		○	[Manual heading input] ON: Enable (* 2) OFF: Disable
5	○		[Language] ON: English OFF: Japanese
6		○	[Panel test] ON: Test OFF: Normal operation
7		○	[Black/white gradation test] ON: Test OFF: Normal operation
8		○	[Color gradation test] ON: Test OFF: Normal operation

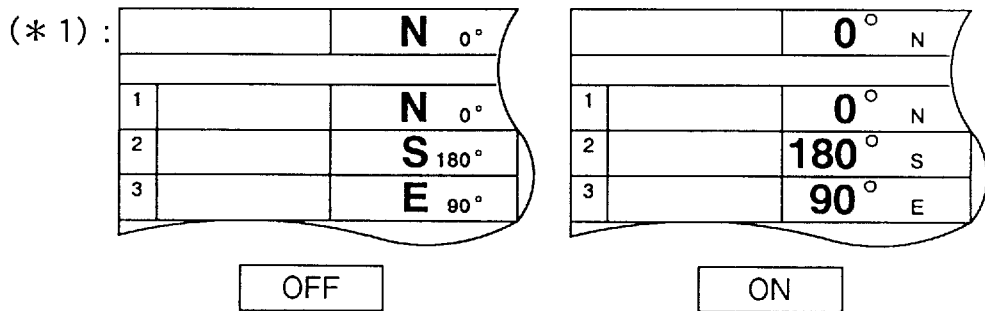

(* 2) : CI-60G is designed to be connected with gyro compass. This switch must be set to OFF position all the time.

COMPLETE SET

No.	NAME	TYPE	WEIGHT	Q'TY	REMARKS
1	Display Unit	CI-600G	19	1	
2	Transceiver Unit	CI-610G	32	1	
3	Junction Box	CI-630	2	1	
4	Transducer	CI-620-1	16	1	w/10m cable
		CI620-2			w/20m cable
5	Transducer Casing & Thru-hull Pipe	CI-620-K-S CI-620-T-S	69	1	for steel hull
		CI-620-K-F CI-620-T-F	25		for FRP hull
6	Installation Materials			1 set	
7	Accessories			1 set	
8	Spare Parts			1 set	
9	DC - AC Inverter	TR-2450 or CSH-5050			optional

INSTALLATION MATERIALS (Display Unit)

No.	NAME	TYPE	CODE NO.	Q'TY	REMARKS
1	Copper Strap	WEA-1004	500-310-040	1	GND
2	Connector	PRC03-12A10-5M	000-110-696	1	P33 (EXT ALARM)
3	Connector	NCS-252-P	000-506-501	1	P31 (POWER)
4	Connector	SRCN6A21-16P	000-508-664	1	P32 (SIG)

INSTALLATION MATERIALS (Transceiver Unit)

No.	NAME	TYPE	CODE NO.	Q'TY	REMARKS
1	Copper Strap	WEA-1004	500-310-040	1	GND
2	Connector	NCS-303-P	000-110-561	1	P7 (MAIN POWER)
3	Crimp-on Lug	FV0.5-3.7 YEL	000-118-307	10	for TB1
4	Crimp-on Lug	FV2-P4 BLU	000-120-199	5	4-pair cable shield
5	Crimp-on Lug	FV2-P3.5 BLU	000-120-200	6	for TB1 (shield)
6	Connector	17JE-23250-02	000-120-201	2	P103 (NMEA)
7	Housing Case	17JE-25H-1A	000-120-202	2	P103 (NMEA)
8	Connector	SRCN6A16-10P	000-508-663	1	P102 (CIF)
9	Connector	SRCN6A13-5S	000-508-666	1	P105
10	Crimp-on Lug	FV1.25-M3 RED	000-538-110	16	for TB1
11	Crimp-on Lug	FV1.25-4	000-538-114	9	4-pair cable core
12	Crimp-on Lug	FV5.5-5 YEL	000-114-733	2	4-pair cable outer shield
13	Crimp-on Lug	FV2-5 BLU	000-107-331	2	for armor ground
14	Vinyl Wire	VSF2.0sq * 5M *	000-121-401	1	for armor ground

INSTALLATION MATERIALS (JUNCTION BOX)

No.	NAME	TYPE	CODE NO.	Q'TY	REMARKS
1	Copper Strap	WEA-1004	500-310-040	1	GND
2	Tapping Screw	5x25 SUS304	000-802-082	4	
3	Crimp-on Lug	FV2-P4 BLU	000-120-199	10	for cable shield
4	Crimp-on Lug	FV1.25-4	000-538-114	18	for cable core
5		FV5.5-5 YEL	000-114-733	2	outer shield/armor

INSTALLATION MATERIALS (CABLES)

No.	NAME	TYPE	CODE NO.	Q'TY	REMARKS
1	Signal Cable Assy.	S66-4-10 (20P) *10M*	006-924-510		Display ↔ Transceiver (To be selected)
		S66-4-20 (20P) *20M*	006-924-520		
		S66-4-30 (20P) *30M*	006-924-530		
4	Power Cable Assy.	S66-1-10 *10M*	006-924-540		Display ↔ Transceiver (To be selected)
		S66-1-20 *20M*	006-924-550		
		S66-1-30 *30M*	006-924-560		
7	4-Pair Cable	66S1067 *5M*	000-120-210		Transceiver ↔ J-Box (To be selected)
		66S1067 *10M*	000-120-226		
		66S1067 *15M*	000-120-227		
		66S1067 *20M*	000-120-228		
		66S1067 *30M*	000-120-229		

ACCESSORIES

No.	NAME	TYPE	CODE NO.	Q'TY	REMARKS
1	12" CRT Filter	02-083-1601-1	100-103-561	1	
2	Hood Assy.	FP03-02910	008-223-520	1	
3	Plastic Cover	66-017-2111	000-802-058	1	

SPARE PARTS (FOR 100/110/115/120VAC)

No.	NAME	TYPE	CODE NO.	Q'TY	REMARKS
1	Fuse	FGMB 0.5A AC125V	000-114-994	3	Display Unit
2	Fuse	FGBO-A 5A AC125V	000-549-064	6	Display Unit
3	Fuse	FGBO 7A AC125V	000-549-013	5	Transceiver Unit
4	Fuse	FGBO-A 1A AC125V	000-549-061	3	Transceiver Unit
5	Fuse	FGBO-A 3A AC125V	000-549-063	3	Transceiver Unit
6	Fuse	FGBO-A 5A AC125V	000-549-064	3	Transceiver Unit
7	Fuse	FGBO 10A AC125V	000-549-065	3	Transceiver Unit
8	Fuse	FGBO 15A AC125V	000-549-014	4	Transceiver Unit
9	Spare Parts Box	FOR F710	000-831-610	1	

SPARE PARTS (FOR 200/220/230/240VAC)

No.	NAME	TYPE	CODE NO.	Q'TY	REMARKS
1	Fuse	FGMB 0.5A AC125V	000-114-994	3	Display Unit
2	Fuse	FGBO-A 5A AC125V	000-549-064	6	Display Unit
3	Fuse	FGBO 7A AC125V	000-549-013	5	Transceiver Unit
4	Fuse	FGBO-A 1A AC125V	000-549-061	3	Transceiver Unit
5	Fuse	FGBO-A 3A AC125V	000-549-063	3	Transceiver Unit
6	Fuse	FGBO-A 5A AC125V	000-549-064	3	Transceiver Unit
7	Fuse	FGBO 10A AC125V	000-549-065	3	Transceiver Unit
8	Fuse	FGBO 10A AC125V	000-549-067	4	Transceiver Unit
9	Spare Parts Box	FOR F710	000-831-610	1	