

Invacare® InTouch™ Stabilite™ Cushion

HCPCS Code = E2607, E2608 (Gentle Contour) E2605 (Max Contour)

The Invacare® InTouch™ Stabilite™ Seat Cushion was developed to provide pelvic stability and leg positioning for patients with postural asymmetry. The Stabilite Cushion comes fitted with a ThinAir™ liner, a unique comfort layer that assists in redistributing peak pressures away from bony prominences as well as with the management of shear forces that occur with activities of daily living.

Invacare® InTouch™ Flovair™ Cushion

HCPCS Code = E2607, E2608 (Gentle/Max Contour)

The Invacare® InTouch™ Flovair™ Seat Cushion was developed to provide pelvic stability, leg positioning and pressure management for patients with postural asymmetry and skin integrity concerns. It incorporates a fluid overlay used in tandem with the ThinAir™ liner to maximize surface area for optimal pressure redistribution. Additionally, the layers work to reduce build up of shear forces against the user while minimizing overall product weight. The InTouch Flovair cushion is a great choice where positioning needs and pressure management requirements are both key goals.

Invacare® InTouch™ Stabilite™ OM Cushion

HCPCS Code = E2605, E2606

The Invacare® InTouch™ Stabilite™ OM Seat Cushion was developed to address positioning needs for a level pelvis or a mild to moderate pelvic obliquity. It is a uniquely simple design for using inserts under the sacral region of the cushion to manage mild to moderate obliquities, now or in the future.

Invacare® InTouch™ Propel™ Back

HCPCS Code = E2611

The Invacare® InTouch™ Propel™ Back is a general purpose back support so lightweight and comfortable, consumers will forget it's there. Hardware installation is no longer a hassle: just grab it, set it and go. The rigid shell coupled with a soft, contoured foam cushion provides gentle support and facilitates postural symmetry. The Propel Back provides a stable surface for propulsion and completion of activities of daily living and daily mobility. Consumers will leave ordinary back upholstery in the past when they try the InTouch Propel Back.

Invacare® InTouch™ PCS Back

HCPCS code = E2620/ E2621

The Invacare® InTouch™ PCS Back was developed to be a lightweight positioning back with applications for both manual and power chair users, for upright seating systems and for tilt and/or recline systems. The back was designed with features including scapular cutouts, three inches of lateral contour depth, soft foam, sacral support, height/angle/depth adjustability and optional thoracic lateral supports and pelvic stabilizers that synergize to provide the exceptional Positioning, Comfort and Stability required by wheelchair users everyday.

INVACARE®

Seating & Positioning



© 2010 Invacare Corporation.

All rights reserved. Trademarks are identified by the symbols ™ and ®. All trademarks are owned by or licensed to Invacare Corporation unless otherwise noted. FloGel® is a registered trademark of S.N.F.

Specifications are subject to change without notification.



INVACARE®

Seating & Positioning

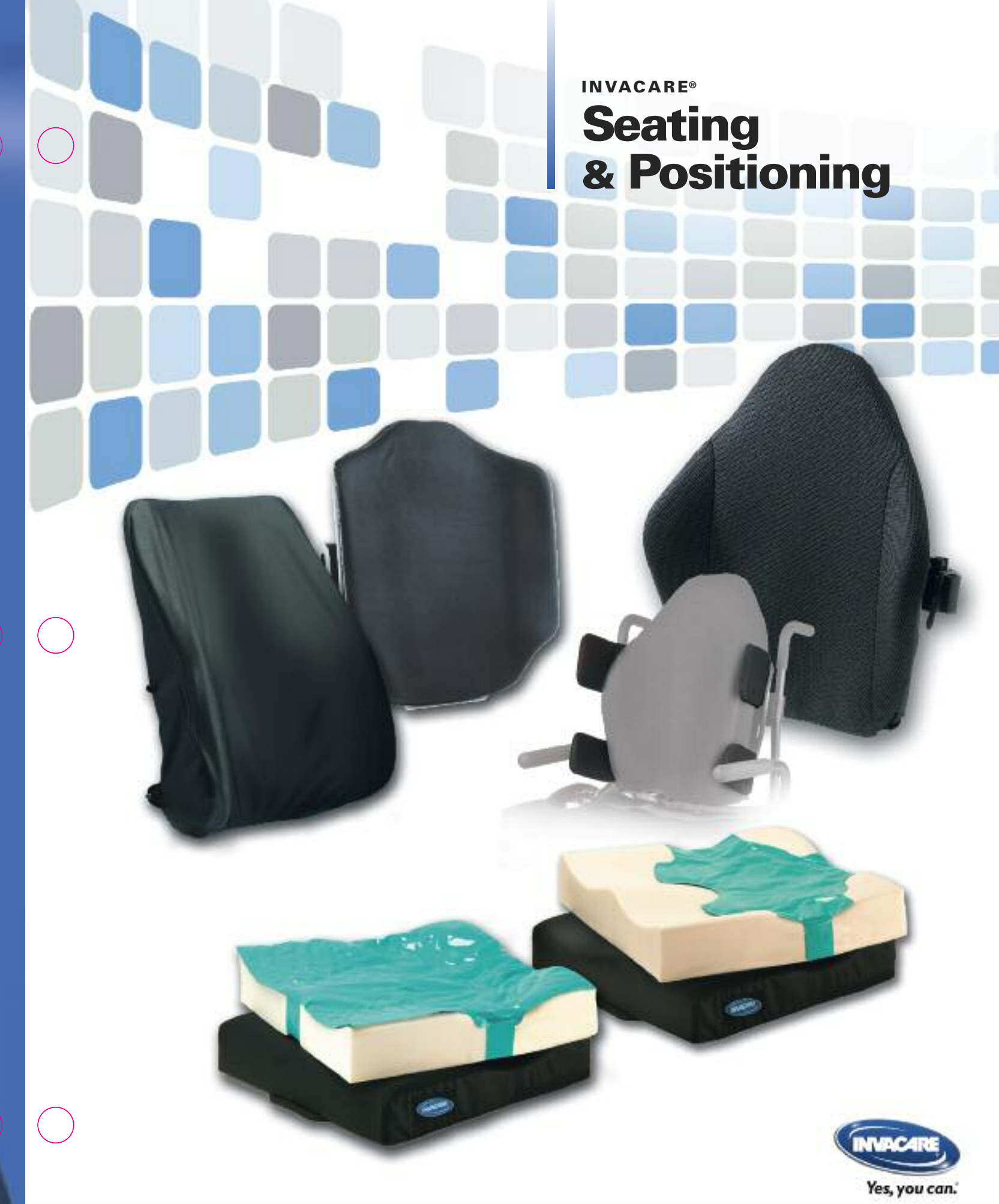



Invacare® Rehab Seating & Positioning Products

With the number of new seating and positioning products available today, it's only natural to choose the products that you know best. Invacare® Seating and Positioning products offer a clinical benefit while making life more comfortable for the consumer. This catalog is your source for Invacare Seating and Positioning products.



Whether it's the comfort and style of an Invacare® Absolute™ Cushion, the revolutionary Invacare® InTouch™ Flovair™ Cushion or the Invacare® Stabilite™ Cushion, Invacare Seating and Positioning products provide optimal solutions for any individual's seating needs. Not only do Invacare products raise the benchmark in functionality and comfort for the consumer, they also ensure that all providers can have confidence in these quality products.



For your convenience, we have included a perforated Off-the-Shelf Product Guide that can be easily torn out and used for reference. Post it on the wall, place it in a binder or keep it with you as you travel to see clients. However you decide to use it, we hope it helps in choosing the right Invacare products.

Invacare is committed to providing you with products that exceed your expectations. As the landscape of seating changes, Invacare's dedication to innovation, quality and, most of all, your comfort, will stay the same.

TEAR ALONG THIS EDGE

Off-the-Shelf (OTS) Product Guide*

HCPCS Code	HCPCS Code Description	Qualifying Diagnosis (Short List)	Featured Products	Available Products
E2601	General Use Wheelchair Seat Cushion, Width Less Than 22", Any Depth	Not Specified		E2601 Absolute™ Single Density
E2602	General Use Wheelchair Seat Cushion, Width 22" or Greater, Any Depth			E2602 Absolute™ Single Density
E2603	Skin Protection Wheelchair Seat Cushion, Width Less Than 22", Any Depth	Spinal Cord Injury (paraplegia, quadriplegia), Other Spinal Cord Disease, Multiple Sclerosis, Cerebral Palsy, Amyotrophic Lateral Sclerosis, Post Polio, Traumatic Brain Injury, Spina Bifida, Childhood Cerebral Degeneration, Alzheimer's Disease, Parkinson's Disease, Hemiplegia, Huntington's chorea, Idiopathic torsion dystonia, Athetoid Cerebral Palsy, Transverse myelitis		E2603 Infinity® LoContour ViscoFoam Infinity® LoContour HoGel™ Comfort-Mate Extra
E2604	Skin Protection Wheelchair Seat Cushion, Width 22" or Greater, Any Depth			E2604 Infinity® LoContour ViscoFoam Infinity® LoContour HoGel™ Comfort-Mate Extra
K0734	Adjustable Skin Protection Wheelchair Seat Cushion, Width Less Than 22", Any Depth	Spinal Cord Injury (paraplegia, quadriplegia), Other Spinal Cord Disease, Multiple Sclerosis, Cerebral Palsy, Amyotrophic Lateral Sclerosis, Post Polio, Traumatic Brain Injury, Spina Bifida, Childhood Cerebral Degeneration, Alzheimer's Disease, Parkinson's Disease, Hemiplegia, Huntington's chorea, Idiopathic torsion dystonia, Athetoid Cerebral Palsy, Transverse myelitis		Infinity® LoContour AirFlo™
K0735	Adjustable Skin Protection Wheelchair Seat Cushion, Width 22" or Greater, Any Depth			
E2605	Positioning Wheelchair Seat Cushion, Width Less Than 22", Any Depth	Spinal Cord Injury (paraplegia, quadriplegia), Cerebral Palsy, Paralysis, Post Polio, Amyotrophic Lateral Sclerosis, Monoplegia of Lower Limb, Hemiplegia, Muscular Dystrophy, Alzheimer's Disease, Spina Bifida, Multiple Sclerosis, Traumatic amputation of leg(s), Osteogenesis imperfecta, Transverse myelitis		E2605 InTouch™ Stabilite™ Max Contour InTouch™ Stabilite™ OM Ulti-Mate™
E2606	Positioning Wheelchair Seat Cushion, Width 22" or Greater, Any Depth			E2606 InTouch™ Stabilite™ OM Ulti-Mate™
E2607	Skin Protection & Positioning Wheelchair Seat Cushion, Width Less Than 22", Any Depth	Spinal Cord Injury (paraplegia, quadriplegia), Other Spinal Cord Disease, Multiple Sclerosis, Cerebral Palsy, Post Polio, Traumatic Brain Injury, Spina Bifida, Amyotrophic Lateral Sclerosis, Alzheimer's Disease, Parkinson's Disease, Monoplegia of Lower Limb, Hemiplegia, Muscular Dystrophy		E2607 InTouch™ Flovair™ Gentle/Max Contour InTouch™ Stabilite™ Gentle Contour Infinity® Gentle/Max Contour ViscoFoam Infinity® Gentle/Max Contour HoGel™
E2608	Skin Protection & Positioning Wheelchair Seat Cushion, Width 22" or Greater, Any Depth			E2608 InTouch™ Flovair™ Gentle Contour InTouch™ Stabilite™ Gentle Contour Infinity® Gentle/Max Contour ViscoFoam Infinity® Gentle/Max Contour HoGel™
K0736	Adjustable Skin Protection & Positioning Wheelchair Seat Cushion, Width Less Than 22", Any Depth	Spinal Cord Injury (paraplegia, quadriplegia), Other Spinal Cord Disease, Multiple Sclerosis, Cerebral Palsy, Post Polio, Traumatic Brain Injury, Spina Bifida, Amyotrophic Lateral Sclerosis, Alzheimer's Disease, Parkinson's Disease, Monoplegia of Lower Limb, Hemiplegia, Muscular Dystrophy		Infinity® Gentle/Max Contour AirFlo™
K0737	Adjustable Skin Protection & Positioning Wheelchair Seat Cushion, Width 22" or Greater, Any Depth			

HCPCS Code	HCPCS Code Description	Qualifying Diagnosis (Short List)	Featured Products	Available Products
E2611	General Use Wheelchair Back Cushion, Width Less Than 22", Any Height, Including Any Type Mounting Hardware	Not Specified		E2611 InTouch™ Propel™ Curved Back
E2612	General Use Wheelchair Back Cushion, Width 22" or Greater, Any Height, Including Any Type Mounting Hardware			E2612 InTouch™ Propel™ Curved Back
E2615	Positioning Wheelchair Back Cushion, Posterior-Lateral, Width Less Than 22", Any Height, Including Any Type Mounting Hardware	Spinal Cord Injury (paraplegia, quadriplegia), Cerebral Palsy, Paralysis, Post Polio, Amyotrophic Lateral Sclerosis, Monoplegia of Lower Limb, Hemiplegia, Muscular Dystrophy, Alzheimer's Disease, Spina Bifida, Multiple Sclerosis, Traumatic amputation of leg(s) (complete/partial), Osteogenesis imperfecta, Transverse myelitis		E2615 Infinity® DualFlex™10 Personal Back™10 Personal Back™10 Plus
E2616	Positioning Wheelchair Back Cushion, Posterior-Lateral, Width 22" or Greater, Any Height, Including Any Type Mounting Hardware			E2616 Infinity® DualFlex™10 Personal Back™10 Personal Back™10 Plus
E2620	Positioning Wheelchair Back Cushion, Planar with Lateral Supports, Width Less Than 22", Any Height, Including Any Type Mounting Hardware	Spinal Cord Injury (paraplegia, quadriplegia), Cerebral Palsy, Paralysis, Post Polio, Amyotrophic Lateral Sclerosis, Monoplegia of Lower Limb, Hemiplegia, Muscular Dystrophy, Alzheimer's Disease, Spina Bifida, Multiple Sclerosis, Traumatic amputation of leg(s) (complete/partial), Osteogenesis imperfecta, Transverse myelitis		E2620 InTouch™ PCS
E2621	Positioning Wheelchair Back Cushion, Planar with Lateral Supports, Width 22" or Greater, Any Height, Including Any Type Mounting Hardware			E2621 InTouch™ PCS

* Providers are responsible for determining the appropriate billing codes when submitting claims to the Medicare Program and should consult an attorney or other advisor to discuss specific situations in further detail. This information is subject to change without notice.
 † Qualifying diagnosis code requires additional provision for decubitus ulcer (707.03, 707.04, 707.05)

Page Reference Guide

Invacare® Seat Cushions

Product	HCPCS Code	Page
Absolute™	E2601	1-2
Single Density	E2601/E2602	1-2
Comfort-Mate Extra	E2603/E2604	1-2
Infinity® LoContour ViscoFoam	E2603/E2604	3-4
Infinity® LoContour FloGel®	E2603/E2604	3-4
InTouch™ Stabilite™ Max Contour	E2605	5-8
InTouch™ Stabilite™ OM	E2605/E2606	5-8
InTouch™ Flovair™ Gentle/Max Contour	E2607/E2608	5-8
InTouch™ Stabilite™ Gentle Contour	E2607/E2608	5-8
Infinity® Gentle/Max ViscoFoam	E2607/E2608	3-4
Infinity® Gentle/Max FloGel®	E2607/E2608	3-4
Infinity® LoContour AirFlo™	K0734/K0735	3-4
Infinity® Gentle/Max Contour AirFlo™	K0736/K0737	3-4

Invacare® Backs

Product	HCPCS Code	Page
InTouch™ Propel™	E2611	11-12
Personal Back™10	E2615/E2616	11-12
Personal Back™10 Plus	E2615/E2616	11-12
InTouch™ PCS	E2620/E2621	9-10

Accessories

13-14

Specifications

15

Invacare® Absolute™ and Single Density Cushions: Simple seating solutions for comfort, fit and function.

For individuals with mild to moderate seating needs, the Invacare® Absolute™ and Single Density cushions offer simple, but highly functional solutions. These cushions are designed to provide basic comfort using highly resilient foam.



HCPGS Code = E2601

Absolute™ Cushion

Model no. EC

Features and Functional Benefits

- **Lightweight Molded Polyurethane foam:** Provides comfort and durability
- **Gentle Contour:** For comfort and centering in the seat
- **Shaped cushion bottom:** Allows use of cushion on taut sling upholstery
- **Outer cover:** Breathable water repellant cover to protect foam and keep the consumer dry
- **Non-slip bottom:** Keeps cushion secure and in place



HCPGS Code = E2601/E2602

Single Density Cushion

Model no. SD

Features and Functional Benefits

- **Lightweight Contoured foam with deformation cut:** Provides comfort and stability to the individual
- **Outer cover:** Durable water repellant cover to protect foam and keep the consumer dry

Invacare® Comfort-Mate Extra

The Invacare® Comfort-Mate Extra cushion goes one step further with a comfortable, molded design and a durable moisture-resistant coating.



HCPGS Code = E2603/E2604

Comfort-Mate Extra Cushion

Model no. CMEX

Features and Functional Benefits

- **Low profile, lightweight cushion:** Designed for long-term sitting comfort and easy lateral transfers
- **Molded dual-firmness polyurethane foam:** Soft top layer provides exceptional comfort and firmer bottom layer stabilizes and supports the pelvis
- **Contoured seating surface:** Promotes neutral leg positioning while providing gentle positioning
- **Beveled sides:** Allows use with a drop seat
- **Moisture resistant coating:** Seals and protects foam from moisture; easily wipes clean
- **Outer Cover:** Breathable water repellant cover to keep the user cool and dry

Application

- Intended for individuals:
 - with mild to moderate seating needs
 - who are able to do own weight shift for pressure relief
- Comfort and durability
- Good rental wheelchair cushion

Specifications

Width: 16"–20"

Depth: 16"–18"

A. Height at adductor 3.25"

B. Height at abductor 2.25"

C. Height at rear 2"

Cushion weight approximately 2 lb.

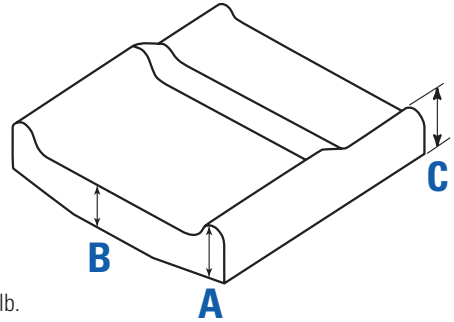

Application

- Designed for individuals from pediatrics to geriatrics:
 - with mild to moderate seating needs
 - who are able to do own weight shift for pressure relief
- Comfort
- Good rental wheelchair cushion

Specifications

Width: 10"–24"

Depth: 7"–20"

A. Height at rear 2"

B. Height at rear (center) 1.5"

C. Height at front 2.5"

Cushion weight approximately 2 lb.

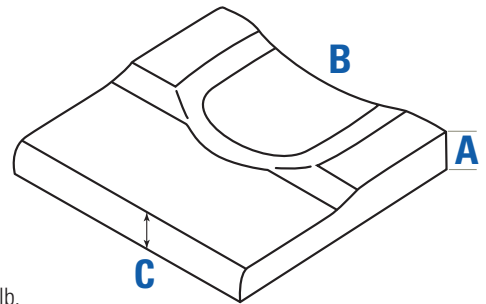

Application

- Ideal for individuals:
 - with long-term care needs
 - who are able to do own weight shifts for pressure relief
 - who need some skin protection
 - who need comfort, stability and gentle positioning
- Good long-term care facility wheelchair cushion
- A great fit for the Infinity® Drop Base to get the desired seat-to-floor height

Specifications

Width: 14"–22"

Depth: 14"–20"

A. Height at adductor 2.625"

B. Height at abductor 3.0"

C. Height at rear 1.75"

D. Height at leg trough 2.25"

Cushion weight approximately 2.3 lb.

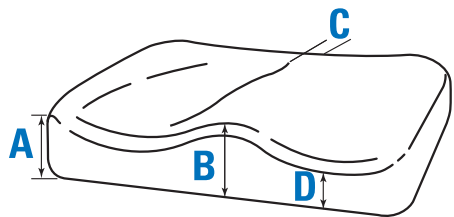

Invacare® Infinity® Cushions

The Invacare® Infinity® line of cushions is designed to provide optimal rehab solutions for comfort, stability and pressure redistribution, as well as address positioning needs. Additionally, these versatile modular seating solutions can be modified to meet current user needs or accommodate future changes. The Infinity cushions are constructed with three support layers - the base layer and the integrated middle pelvic support layer with an ischial insert. In the Invacare® AirFlo™ cushion, the integrated pelvic support and ischial layers are replaced with 2" air flotation cells. The Infinity cushions are available in three different contours - Lo, Gentle and Max.

Features and Functional Benefits

- **Lightweight Polyurethane foam base:** Provides adequate postural support
- **Contoured top foam:** Provides comfort and enhances pelvic stability
- **Integrated Middle Support Layer:** Adjusts to correct or accommodate pelvic obliquity
- **Integrated Ischial Insert:** Conforms to sensitive bony prominences and allows optimal immersion for comfort, stability and pressure relief
- **AirFlo Cells:** Provide optimal immersion and suspension of bony prominences for pressure redistribution
- **Inner cover:** Recovery material that is moisture proof and water resistant with 4-way stretch to allow immersion
- **Outer cover:** 4-way stretch, water resistant, breathable cover to dissipate heat and moisture
- **Optional Removal leg wedges:** Allows lower seat-to-floor height for foot propellers or accommodates limited hip flexion (opens up seat to back angle)
- **Optional Leg Length Cutouts:** 1; or 2" cutouts to accommodate leg length discrepancies

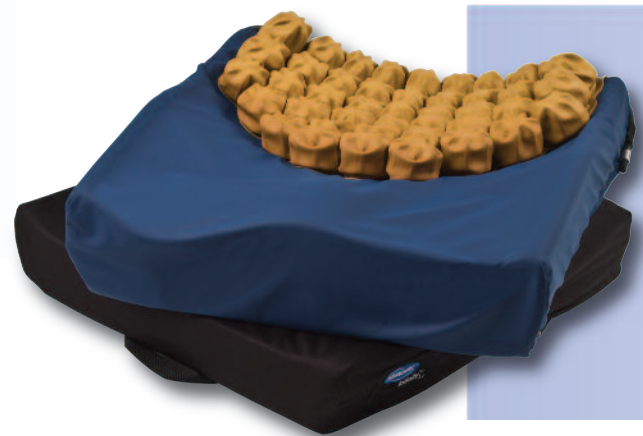
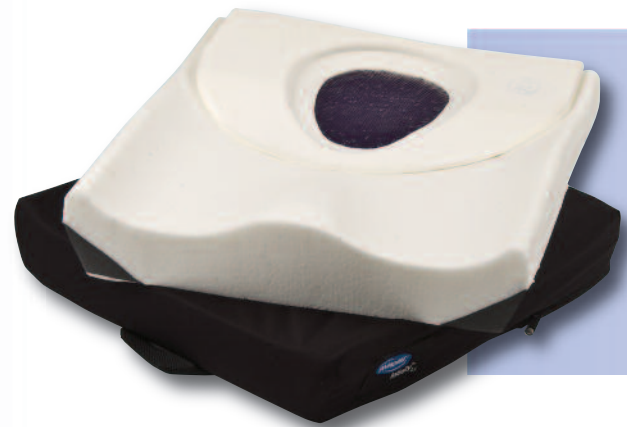

**HCPCS Code = E2607/E2608 (Gentle/Max Contour)
E2603/E2604 (LoContour)**

ViscoFoam Cushion

Model no. ILCVF, IGCVF, IMCVF

Integrated ischial insert is very soft visco foam

Application

- ViscoFoam cushion is an excellent choice for individuals who:
 - Are at high risk of skin breakdown
 - Require excellent support and stability
 - Require a lightweight cushion

**HCPCS Code = E2607/E2608 (Gentle/Max Contour)
E2603/E2604 (LoContour)**

FloGel® by S.N.F. Cushion

Model no. ILCFG, IGCFG, IMCFG

Integrated ischial insert includes layer of gel over very soft visco foam

Application

- FloGel® cushion is an excellent choice for individuals who:
 - Are at high risk of skin breakdown
 - Require excellent support and stability
 - Require a good dynamic shear reduction

**HCPCS Code = K0736/K0737 (Gentle/Max Contour)
K0734/K0735 (LoContour)**

AirFlo™ Cushion

Model no. ILCAIR, IGCAIR, IMCAIR

Single hand operated air inflation bulb allows easy adjustment

Application

- AirFlo™ cushion is an excellent choice for individuals who:
 - Have a history of or are considered to be at very high risk of skin breakdown
 - Require an air flotation insert for immersion of bony prominences
 - Require a postural support base for stability

LoContour

LoContour is an excellent choice for individuals who:

- Have good postural control
- Need to accommodate postural asymmetry, for example, windswept hips
- Need low profile for lateral transfer
- Foot propel

Specifications

Width: 13"–22"

Depth: 15"–20"

- A.** Height at adductor 2.75"
- B.** Height at abductor 2.25"
- C.** Height at leg trough 2.25"

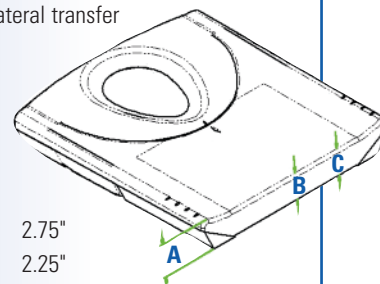

Gentle Contour

Gentle Contour is an excellent choice for individuals who:

- Have moderate postural instability
- Require gentle control of posture
- Need moderate control of abduction/adduction tendency

Specifications

Width: 13"–22"

Depth: 15"–20"

- A.** Height at adductor 3.38"
- B.** Height at abductor 3.38"
- C.** Height at leg trough 2.25"

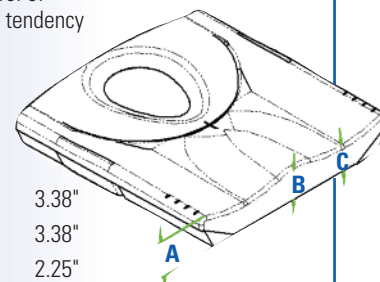

Max Contour

Max Contour is an excellent choice for individuals who:

- Require high level of postural control
- Require optimal pressure reduction and redistribution

Specifications

Width: 13"–22"

Depth: 15"–20"

- A.** Height at adductor 4.25"
- B.** Height at abductor 4.40"
- C.** Height at leg trough 2.66"

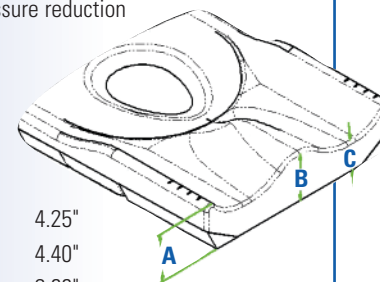



InTouch™ Flovair™ Cushion



InTouch™ Stabilite™ Cushion



InTouch™ Stabilite™ OM Cushion

Invacare® InTouch™ Cushions

The Invacare® InTouch™ Seat Cushions begin with the base for comfort, stability and function. The Stabilite™, Flovair™ and Stabilite™ OM cushions are three distinct cushions with one clear message- if the base isn't right, nothing else matters.

With the exceptional InTouch Stabilite and Flovair cushions from Invacare, less is more. These hybrid cushions combine contouring in the base with the latest advancements in pressure redistribution technology to create a seating experience like no other. These cushions capture the stability of foam, the pressure redistribution of air and the shear reduction of fluid. This is all accomplished with less volume than has traditionally been used in wheelchair cushions, thus reducing weight and maximizing comfort.

Additionally, the Stabilite OM cushion is intended to provide outstanding positioning and comfort with optimal stability for function. Unique to the design are obliquity inserts under the base that can be utilized to correct or accommodate mild to moderate pelvic obliquities now or in the future.

Positioning Support Base

The larger the surface area, the lower the pressure. Our engineers put purpose behind the contouring of the InTouch base. Leg troughs are slightly abducted. Soft foam envelops the IT's, coccyx and sacrum. Firmer foam supports the trochanters and provides additional pelvic support for stability. Smooth, refined transitions are sculpted to replace steep ridges or uncomfortably placed abductors. The base is designed to maximize functionality and comfort when seated in a wheelchair.



Maximize surface area

Features and Functional Benefits

- **Soft foam:** Allows immersion of the pelvis and increases contact over maximum surface area for maximum comfort, stability and optimal pressure redistribution without bottoming out. By maximizing surface area, pelvic excursion is limited
- **Medial Thigh Support:** Gentle control of adduction tendencies
- **Lateral Thigh Supports:** Gentle control of abduction tendencies and positioning guidance to maintain proper alignment of lower extremities
- **Slightly Abducted Leg Troughs:** Facilitates a neutral to anterior tilt of the pelvis, promoting a stable upright posture
- **Trochanter Cutouts:** Provides pressure distribution anterior and posterior to the trochanters, further promoting a stable pelvis in the seated position
- **Trochanter Support:** Firmer foam on either side of the base under the trochanters provides additional pelvic support for stability
- **Lateral Pelvic Support:** Maintains pelvis in a centered position on the seat and provides lateral pelvic stability and pelvic support
- **Posterior Pelvic Support:** Provides pelvic control required for stability and function
- **Sacral Relief:** Provides additional comfort and support for those sitting in a posterior pelvic tilt
- **Low Profile:** Lowers seat-to-floor height for foot propellers and allows easier lateral transfers without compromising positioning/comfort/stability
- **Optional Removable Leg Wedges:** Lowers front seat-to-floor height for foot propellers and accommodates limited hip flexion by opening up seat to back angle
- **Optional Leg Length Cutouts:** One or two-inch cutouts accommodate leg length discrepancies

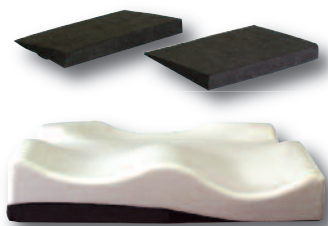

Removable Leg Wedges

Invacare® InTouch™ Stabilite™ Cushion

The Invacare® InTouch™ Stabilite™ seat cushion was developed to provide pelvic stability and leg positioning for patients with postural asymmetry. The Stabilite cushion comes fitted with a patent-pending ThinAir™ liner, a unique comfort layer that assists in reducing shear as well as in redistributing peak pressures away from bony prominences. The Stabilite cushion is a great choice for geriatric or CVA clients.



Invacare® InTouch™ Flovair™ Cushion

The Invacare® InTouch™ Flovair™ seat cushion was developed to provide pelvic stability, leg positioning and pressure management for patients with postural asymmetry and skin integrity concerns. It incorporates a fluid overlay used in tandem with the patent-pending ThinAir™ liner to maximize surface area for optimal pressure redistribution and reduce build up of shear forces against the user, while minimizing overall product weight. The Flovair cushion is a great choice for neuromuscular, TBI or SCI clients without significant obliquity.



Invacare® InTouch™ Stabilite™ OM Cushion

A uniquely simple design for using inserts under the sacral region of the cushion to manage mild to moderate obliquities, now or in the future.



Level

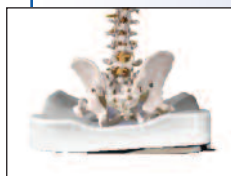

One half-inch adjustment



One-inch adjustment

Obliquity Management

Simple design addresses positioning needs for a level pelvis or a mild to moderate obliquity

- Accommodate obliquities by lowering the cushion on the low side of the oblique pelvis
- Correct obliquities by raising the cushion on the low side of the oblique pelvis
- Keep both inserts in place to address a level pelvis

Bottom View

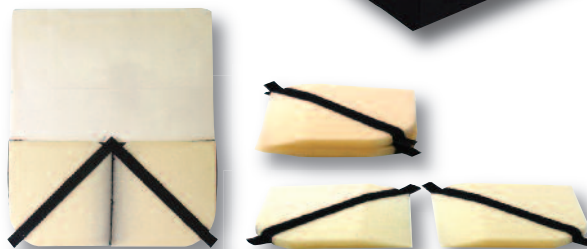

HCPSC Code = E2607/E2608 (Gentle Contour), E2605 (Max Contour)

Stabilite™ Cushion

Model no. ITSG, ITSM

Features and Functional Benefits

- **Positioning foam base:** Supports the pelvis and thighs; helps to prevent adduction and internal rotation
- **ThinAir™ liner:** Helps reduce shear forces that occur during daily activities in a seated position
- **Gentle/Max contour:** Contour choices based on involvement level

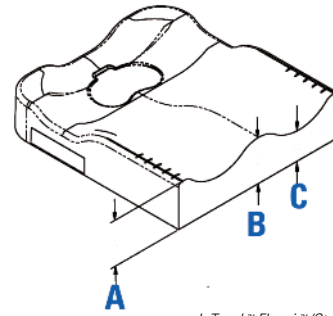

InTouch™ Flovair™/Stabilite™ Gentle Contour

Specifications

	Gentle Contour	Max Contour
Width:	15"–24"	15"–20"
Depth:	15"–22"	15"–20"
A. Height at adductor	3.5"	4.38"
B. Height at abductor	3.5"	4.38"
C. Height at leg trough	2.87"	2.88"

HCPSC Code = E2607/E2608 (Gentle/Max Contour)

Flovair™ Cushion

Model no. ITFG, ITFM

Features and Functional Benefits

- **Positioning foam base:** Supports the pelvis and thighs; helps to prevent adduction and internal rotation
- **Fluid + ThinAir™ liner:** Effectively redistributes pressure without weight penalty. Shear reduction as two layers work in harmony
- **Gentle/Max contour:** Contour choices based on involvement level

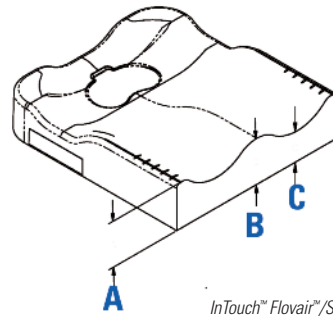

InTouch™ Flovair™/Stabilite™ Max Contour

HCPSC Code = E2605/E2606

Stabilite™ OM Cushion

Model no. ITSOM

Features and Functional Benefits

- **Positioning foam base:** Supports the pelvis and thighs; helps to prevent adduction and internal rotation
- **Low Profile:** Easier transfers without compromising stability/positioning/comfort
- **Obliquity Inserts (Standard):** Allow accommodation or correction of mild to moderate obliquities

Specifications

Width	14"–24"
Depth	14"–22"
Weight capacity	
	14"–20" w = 300 lb.
	21"–24" w = 500 lb.

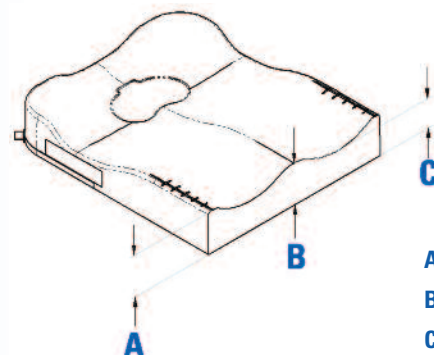

A. = 3.75
B. = 3.75
C. = 2.62

Invacare® InTouch™ PCS Positioning Back

Introducing the Invacare® InTouch™ PCS positioning back with applications for both manual and power chair users, for upright seating systems and for tilt and/or recline systems. The back was designed with features that synergize to provide the exceptional **Positioning, Comfort** and **Stability** required by wheelchair users everyday.

POSITIONING

- Lightweight aluminum back with 3" of lateral contour depth
- Scapular cutouts
- Tapered contours at the sacral portion
- New easy to adjust hardware

COMFORT

- Soft foam over the back shell
- New spacer fabric upholstery
- Unique sizes in 1" width increments

STABILITY

- Optional thoracic lateral supports and pelvic stabilizers for wheelchair users with positioning needs that require additional lateral or pelvic control
- Unique back mounting hardware

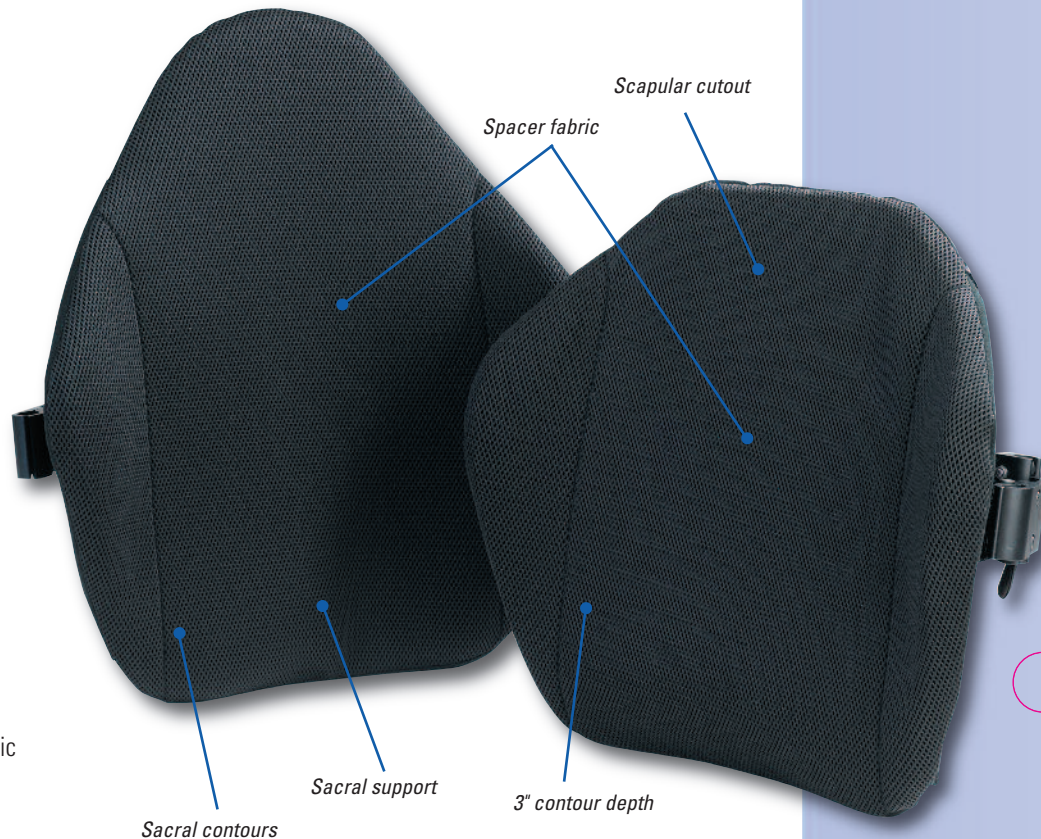

Specifications

Available widths: 14"–24"
Height: 16" (Regular); 20" (Tall)
Depth adjustment: 1.5" to the back
Angle adjust: up to 30°
Product weight: 4.7 lb.

Pre-drilled headrest holes
Aluminum Shell

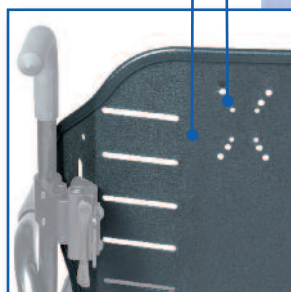

Back Shell

Features and Functional Benefits

- **Aluminum shell:** Lightweight to reduce overall weight of the frame and minimize manual mobility, thereby improving efficiency with propulsion
- **Pre-drilled headrest holes:** Headrest can be mounted directly on the back and easily accommodates standard headrest mounting hardware

HCPGS Code = E2620/E2621

InTouch™ PCS Positioning Back

Model no. ITPCSR, ITPCST

Features and Functional Benefits

- **Regular and tall heights:** Accommodates the different postural requirements and need for taller back supports when used with tilt and/or recline
- **1" soft foam:** Provides optimal comfort with pressure redistribution

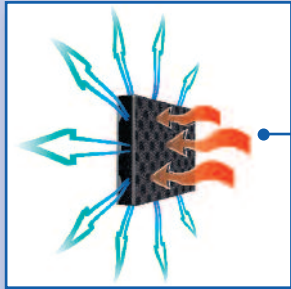

- **Spacer fabric:** Allows for improved airflow between the user and back for optimal management of heat and moisture to promote better skin integrity

*Spacer fabric:
Regulation of heat and moisture*

- **Scapular cutouts:** Facilitates upright positioning with trunk extension without interfering with upper extremity function. By not limiting upper extremity range of motion, overall functionality is maximized

- **3" lateral contour depth:** Provides lateral trunk support to facilitate centering and postural control with proximal stability required for function
- **Sacral support:** Facilitates proximal stability required for function. Provides pelvic control/support for an upright posture with trunk extension
- **Sacral contours:** Tapered contours at the sacral portion of the back allow full contact of the back shell against the user without interfering with hip placement in the seating system
- **One tool assembly:** Only one tool needed for all installations, adjustments and accessories
- **Single-point mounting hardware:** Works with dual-point strength to create stability and securely mounts between canes without any unwanted play, while allowing height, depth and back angle adjustment. Designed to mount onto back canes with an outside diameter of 1" or 7/8"
 - **Angle adjustable hardware:** Allows accommodation of hip range of motion limitations, kyphotic postures and posterior pelvic tilt by opening up seat to back angle
 - **Depth adjustable hardware:** Allows positioning without losing seat depth, thereby maximizing the area of seating surface for optimal pressure redistribution
 - **Height adjustable hardware:** Accommodates user's positioning requirements in the wheelchair

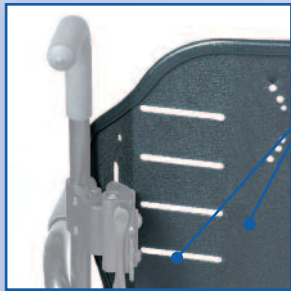

*Height
and width
adjustment
for optional
thoracic
lateral
supports
and pelvic
stabilizers*

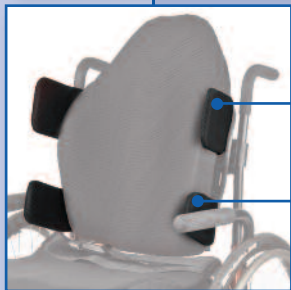

*Thoracic
lateral
supports*

*Pelvic
stabilizers*

Optional Thoracic Lateral Supports: Optional supports (4" tall) provide improved trunk control and stability

Optional Pelvic Stabilizers: Optional supports (3" tall) promote pelvic stability

These optional supports provide additional positioning for the trunk and pelvis to increase support for maximizing upright (spinal extension) and midline (centered) trunk positioning. The thoracic lateral supports and pelvic stabilizers are adjustable in height and width for accommodating fixed posture asymmetries, correcting flexible postural deformities or adjusting over time to support postural changes incrementally in steps. Additionally, these supports act as clinician's hands to keep the patient in the best position identified.

Quick Release Latch:

Allows one hand operation for removal and remount of the back during transport



Quick Release Latch



Lock



Unlock

Invacare® InTouch™ Propel™ Back

Invacare® InTouch™ Propel™ Back is a general purpose back support so lightweight and comfortable consumers will forget it's there. Hardware installation is no longer a hassle: just grab it, set it and go. The rigid shell coupled with a soft contoured foam cushion provides gentle support and facilitates postural symmetry. The Propel Back provides a stable surface for propulsion and completion of daily living activities. Consumers will leave ordinary back upholstery in the past when they try the InTouch Propel Back.



HCPCS Code = E2611

InTouch™ Propel™ Back

Model no. ITPR

Features and Functional Benefits

- **Solid, lightweight back:** Intended to provide support for an upright posture and improved sitting tolerance with less fatigue
- **Soft Foam:** Provides optimal comfort
- **Scapular Cutouts:** Improved upper extremity function and efficient wheelchair propulsion
- **Redundant Tissue Cutouts:** Increased lower back comfort
- **4-way adjustability:** Adjustable in height/width/depth/angle to accommodate user's positioning requirements. Adjustments can be made while user is seated in the chair

Invacare® Personal Back™10 and Personal Back™10 Plus Backs

The Invacare® Personal Back™10 and Personal Back™10 Plus Backs combine simplicity of design with effectiveness of application. The highly popular Personal Back line continues to provide the comfort, postural support and spinal alignment that you have come to expect.

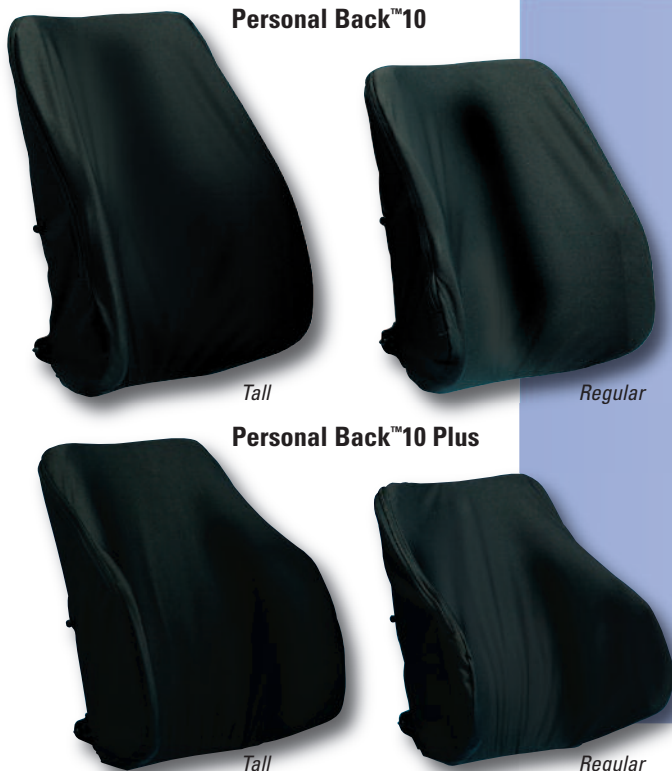

Personal Back™10

Tall

Regular

Personal Back™10 Plus

Tall

Regular

HCPCS Code = E2615/E2616

Personal Back™10 and Personal Back™10 Plus Backs

Model no. PBR, PBT

Model no. PPR, PPT

Features and Functional Benefits

- **Regular and Tall Heights:** Accommodate different user postural requirements
- **Aluminum Shell:** Lightweight and mounts quickly and easily to the wheelchair
- **Pre-contoured shell:** Provides excellent contact, improved lateral stability and support
- **Deep Lateral Contour:** Provides increased midline support without interfering with upper extremity range of motion
- **Pre-drilled headrest pattern:** Allows mounting of standard headrest mounting hardware
- **Quick Set™ hardware:** Allows increased adjustability in height, depth and back angle
- **Optional Foam-in-Place kit:** Provides additional support and positioning for consumers who needs a more custom fit. *See Accessories for additional information*



One-handed quick release



Adjust depth/angle while client is seated



Fits 7/8" or 1" canes with no additional hardware

- **One handed quick release:** Allows easy removal and remounting for transport
- **One tool assembly (7/8" wrench):** Only one tool needed for all installations and adjustments
- **Hardware:** Two point mountings fit 7/8" to 1" canes

Specifications

Width: 16"– 21" (in 1" increments)
 Height: 16.5"
 Depth adjust: 1.75"
 Angle adjust: up to 27°
 Product Weight: 4 lb.

Application: Personal Back™ 10 Back

- The Personal Back10 Back is an excellent choice for individuals who:
 - Require comfort and stability with moderate lateral support
 - Require modifications in seat to back angle for postural accommodation

Application: Personal Back™ 10 Plus Back

- The Personal Back10 Plus Back is an excellent choice for individuals who:
 - Require comfort and stability with increased lateral support
 - Recommended when using the foam-in-place kit
 - Require modifications in seat to back angle for postural accommodation

Specifications

Personal Back™10 Back Heights

Width	Regular	Tall
13" – 14"	14"	16"
15" – 26"	16"	19"

Personal Back™ 10

Width	13"	14"	15"	16"	17"	18"	19"	20"	22"	24"	26"
A (Outer Width)	12.13	13.13	14.13	15.13	16.13	17.13	18.13	19.13	21.13	23.13	25.13
B (Inner Width)	9.50	10.50	11.50	12.50	13.50	14.50	15.50	16.50	18.43	20.43	22.43
C (Contour Width)	5.14	5.28	5.41	5.54	5.68	5.81	5.94	6.08	6.60	6.86	7.13

Personal Back™ 10 Plus

Width	13"	14"	15"	16"	17"	18"	19"	20"	22"	24"	26"
A (Outer Width)	13.00	14.00	15.00	16.00	17.00	18.00	19.00	20.00	22.00	24.00	26.00
B (Inner Width)	9.50	10.50	11.50	12.50	13.50	14.50	15.50	16.50	18.43	20.43	22.43
C (Contour Width)	6.85	6.99	7.12	7.25	7.39	7.52	7.65	7.79	8.27	8.54	8.81

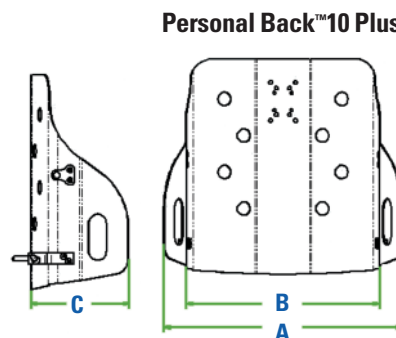
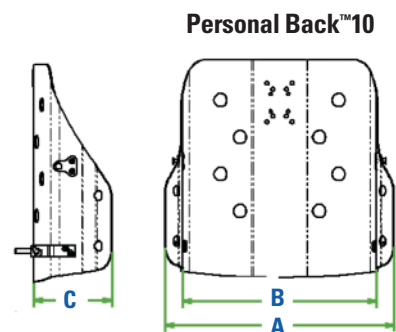

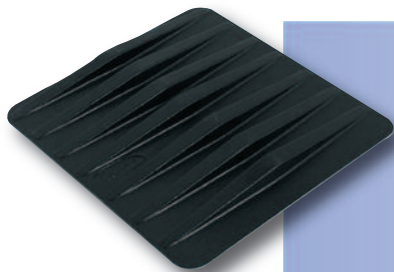

Cushion Rigidizer

- Lightweight plastic seat insert
- Securely attaches to bottom of cushion inside cover
- Fits between seat rails for level support
- Eliminates hammock effect of seat upholstery

Adjustable Headrests

- Contoured head and neck supports available in four styles
- Dual-ball swivel hardware for multi-plane adjustment
- Durable steel reinforced polyurethane pads - easily wipe clean

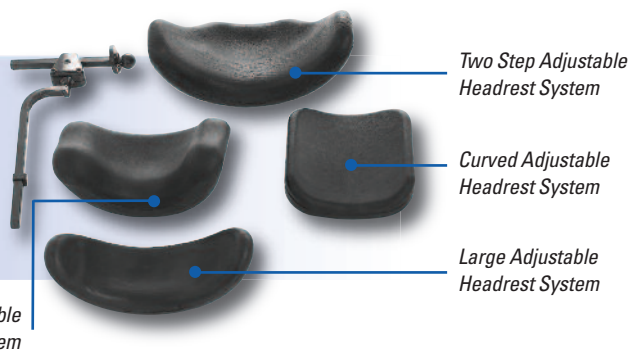

Infinity® Drop Base

- Provides stable support base for the cushion
- Lowers seat-to-floor height which aids in foot propulsion, opens up seat to back angle, allows easy lateral transfers and improves basic functionality when in a seated position
- Width adjustable: Three sizes fit wheelchairs from 14" to 22" wide
- Height and angle adjustable: up to 2" of drop provided
- Portable quick-release hardware allows easy removal of base from wheelchair

Basic Headrest

- Padded to provide comfortable occipital support
- Horizontal and vertical adjustable hardware
- Outer cover easily removes for laundering



Foam-In-Place Kit

- Easy-to-use Foam-in-Place kit provides custom foam mold insert in minutes
- Provides additional support and positioning for users who need a more custom fit
- Custom-molded insert can be easily removed for modification or remolded to meet the changing needs of the user
- Can be used with Personal Back™ 10/ Personal Back™10 Plus



Full Tray - Hook and Loop Mount

- Lightweight and easy to handle
- Break-resistant clear polycarbonate tray surface
- Easily attaches to chair armrest with hook and loop straps
- Removable trim allows thorough cleaning

Belts and Straps

- Three sizes of shoulder supports fit child, junior and adult
- Three sizes of padded lap belts fit child, junior and adult; pinch release buckles
- Push-button style release provides secure attachment
- Three sizes of four-point lap belt to fit child, junior and adult; push button release buckle



Full Tray - Slide-on Mount

- Break-resistant clear polyester resin tray surface
- Width adjustable mounting hardware securely fastens tray to chair arm pads
- Molded-in rim helps keep items on tray



Half Tray - Swingaway

- Break-resistant clear polycarbonate tray surface
- Tray securely bolts to wheelchair armrest and is durable
- Tray easily swings away when not in use
- Molded-in rim helps keep items on tray



Specifications

InTouch™ Stabilite™/Flovair™ Cushions (pages 5-8)

Seat width	15" – 24" Gentle 15" – 20" Max
Seat depth	15" – 22" Gentle 15" – 20" Max
Product weight	3.05 lb. Stabilite 4.20 lb. Flovair
Weight capacity	15" – 20" 250 lb. 21" – 24" 350 lb.
Limited warranty	2 years

InTouch™ Stabilite™ OM (pages 5-8)

Seat width	14" – 24"
Seat depth	14" – 22"
Product weight	3 lb.
Weight capacity	14" – 20" W 300 lb. 21" – 24" W 500 lb.
Limited warranty	2 years

All weights/measurements are approximate

Infinity® Cushions (pages 3-4)

	LoContour	Gentle Contour	Max Contour
Seat width	13" – 22"	13" – 22"	13" – 22"
Seat depth	15" – 20"	15" – 20"	15" – 20"
Product weight	4 lb.	4 lb.	4 lb.
Weight capacity	250 lb.	250 lb.	250 lb.
Limited warranty	2 years	2 years	2 years

InTouch™ Propel™ Back (pages 11-12)

Width range	16" – 21" (1" increments)
Product height	16.5"
Depth adjust	1.75"
Angle adjust	up to 27°
Product weight	4 lb.
Weight capacity	300 lb.
Limited warranty	2 years

All weight/measurements are approximate

InTouch™ PCS Back (pages 9-10)

Available widths: 14" – 24" (1" increments)
Height: 16" (Regular); 20" (Tall)
Depth adjustment: 1.5" to the back
Angle adjust: up to 30°
Product weight: 4.7 lb.
User weight limited: 300 lb. (14" – 21"); 500 lb. (22" – 24")
Limited warranty: 2 years

All weight/measurements are approximate

InTouch™ Personal Back™10 (pages 11-12)

	Personal Back™10	Personal Back™10 Plus
Back height	13" – 14" widths 14", 16" 15" – 26" widths 16", 19"	14", 16" 16", 19"
Back width	13" – 20", 22", 24", 26"	13" – 20", 22", 24", 26"
Product weight	13" – 20" widths 5 lb. 22" – 26" widths 10 lb.	6 lb. 11 lb.
Weight capacity	13" – 20" widths 250 lb. 22" – 26" widths 500 lb.	250 lb. 500 lb.
Limited warranty	2 years	2 years

Invacare Corporation
www.invacare.com

USA

One Invacare Way
Elyria, Ohio
44035-4190
(800) 333-6900

Canada

570 Matheson Blvd. E.
Unit 8
Mississauga, Ontario
L4Z 4G4 Canada
(800) 668-5324

© 2010
Invacare Corporation.

All rights reserved.
Trademarks are identified by the symbols ™ and ®.
All trademarks are owned by or licensed to Invacare Corporation unless otherwise noted.
FloGel is a registered trademark of S.N.F.

Specifications are subject to change without notification.

Form No. 06-043
Rev. 03/10

