

marantz®

Model DV4200 User Guide

DVD Player



Safety Precautions

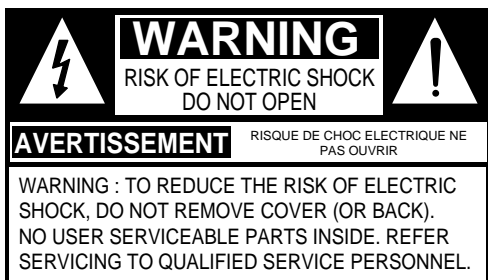

The lightning flash with arrowhead symbol, within an equilateral triangle, is intended to alert the user to the presence of uninsulated 'dangerous voltage' within the product's enclosure that may be of sufficient magnitude to constitute a risk of electric shock to persons.



The exclamation point within an equilateral triangle is intended to alert the user to the presence of important operating and maintenance (servicing) instructions in the literature accompanying the appliance.

WARNING:
TO REDUCE THE RISK OF FIRE OR ELECTRIC SHOCK, DO NOT EXPOSE THIS PRODUCT TO RAIN OR MOISTURE.

CAUTION:
TO PREVENT ELECTRIC SHOCK, MATCH WIDE BLADE OF PLUG TO WIDE SLOT, FULLY INSERT.

ATTENTION:
POUR EVITER LES CHOCS ELECTRIQUE, INTRODUIRE LA LAME LA PLUS LARGE DE LA FICHE DANS LA BORNE CORRESPONDANTE DE LA PRISE ET POUSSER JUSQU'AU FOND.

CAUTION:
 This Digital Video Disc Player employs a Laser System. To ensure proper use of this product, please read this owner's manual carefully and retain for future reference, should the unit require maintenance, contact an authorized service location-see service procedure. Use of controls, adjustments or the performance of procedures other than those specified may result herein hazardous radiation exposure. To prevent direct exposure to laser beam, do not try to open the enclosure. Visible laser radiation when open the enclosure. **DO NOT STARE INTO BEAM.**

FCC NOTICE:
 This equipment has been tested and found to comply with the limits for a Class B digital device, pursuant to part 15 of the FCC Rules. These limits are designed to provide reasonable protection against harmful interference in a residential installation. This equipment generates, uses, and can radiate radio frequency energy and, if not installed and used in accordance with the instructions, may cause harmful interference to radio communications. However, there is no guarantee that interference will not occur in a particular installation. If this equipment does cause harmful interference to radio or television reception, which can be determined by turning the equipment off and on, the user is encouraged to try to correct the interference by one or more of the following measures:

- Reorient or relocate the receiving antenna.
- Increase the separation between the equipment and receiver.
- Connect the equipment into an outlet on a circuit different from that to which the receiver is connected.
- Consult the dealer or an experienced radio/TV technician for help.

FCC WARNING:
 Changes or modifications not expressly approved by the party responsible for compliance could void the user's authority to operate the equipment.

INDUSTRY CANADA REQUIREMENT :
 This Class B digital apparatus meets all requirements of the Canadian Interference-Causing Equipment Regulations. Cet appareil numérique de la classe B respecte toutes les exigences du Règlement sur le matériel brouilleur du Canada.

**FIGURE 1
 EXAMPLE OF ANTENNA GROUNDING ACCORDING TO
 NATIONAL ELECTRICAL CODE INSTRUCTIONS
 CONTAINED IN ARTICLE 810 - "RADIO AND TELEVISION EQUIPMENT"**

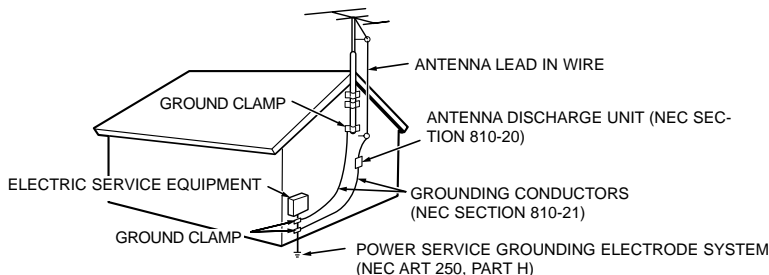

NOTE TO CATV SYSTEM INSTALLER:
 This reminder is provided to call the CATV (Cable-TV) system installer's attention to Article 820-40 of the NEC, that provides guidelines for proper grounding and, in particular, specified that the cable ground shall be connected to the grounding system of the building, as close to the point of cable entry as practical.

IMPORTANT SAFETY INSTRUCTIONS

CAUTION: PLEASE READ AND OBSERVE ALL WARNINGS AND INSTRUCTIONS IN THIS OWNER'S MANUAL AND THOSE MARKED ON THE UNIT. RETAIN THIS BOOKLET FOR FUTURE REFERENCE.

This set has been designed and manufactured to assure personal safety. Improper use can result in electric shock or fire hazard. The safeguards incorporated in this unit will protect you if you observe the following procedures for installation, use and servicing.

This unit is fully transistorized and does not contain any parts that can be repaired by the user.

DO NOT REMOVE THE CABINET COVER, OR YOU MAY BE EXPOSED TO DANGEROUS VOLTAGE. REFER SERVICING TO QUALIFIED SERVICE PERSONNEL ONLY.

1. Read owner's manual

After unpacking this product, read the owner's manual carefully, and follow all the operating and other instructions.

2. Power Sources

This product should be operated only from the type of power source indicated on the marking label. If you are not sure of the type of power supply in your home, consult your product dealer or local power company. For products intended to operate from battery power, or other sources, refer to the operating instructions.

3. Grounding or Polarization

This product is equipped with a polarized alternating current line plug (a plug having one blade wider than the other). This plug will fit into the power outlet only one way. This is a safety feature. If you are unable to insert the plug fully into the outlet, try reversing the plug. If the plug should still fail to fit, contact your electrician to replace your obsolete outlet. Do not defeat the safety purpose of the polarized plug.

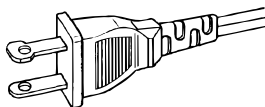

AC POLARIZED PLUG

4. Ventilation

Slots and openings in the cabinet are provided for ventilation and to ensure reliable operation of the product and to protect it from overheating. These openings must not be blocked or covered. The openings should never be blocked by placing the product on a bed, sofa, rug or other similar surface. This product should not be placed in a built-in installation such as a bookcase or rack unless proper ventilation is provided or the manufacturer's instructions have been adhered to.

5. Heat

The product should be situated away from heat sources such as radiators, heat registers, stoves, or other products (including amplifiers) that produce heat.

6. Water and Moisture

Do not use this product near water—for example, near a bath tub, wash bowl, kitchen sink, or laundry tub; in a wet basement; or near a swimming pool and the like.

7. Cleaning

Unplug this product from the wall outlet before cleaning. Do not use liquid cleaners or aerosol cleaners. Use a damp cloth for cleaning.

8. Power-Cord Protection

Power-supply cords should be routed so that they are not likely to be walked on or pinched by items placed upon or against them, paying particular attention to cords at plugs, convenience receptacles, and the point where they exit from the product.

9. Overloading

Do not overload wall outlets, extension cords, or integral convenience receptacles as this can result in a risk of fire or electric shock.

10. Lightning

For added protection of this product during storms, or when it is left unattended and unused for long periods of time, unplug it from the wall outlet. This will prevent damage to the product due to lightning and power-line surges.

11. Object and Liquid Entry

Never push objects of any kind into this product through openings as they may touch dangerous voltage points or short-out parts that could result in a fire or electric shock. Never spill liquid of any kind on the product.

12. Attachments

Do not use attachments not recommended by the product manufacturer as they may cause hazards.

IMPORTANT SAFETY INSTRUCTIONS (Cont'd)

13. Accessories

Do not place this product on an unstable cart, stand, tripod, bracket, or table. The product may fall, causing serious injury to a child or adult, and serious damage to the product. Use only with a cart, stand, tripod, bracket, or table recommended by the manufacturer, or sold with the product. Any mounting of the product should follow the manufacturer's instructions, and should use a mounting accessory recommended by the manufacturer. A product and cart combination should be moved with care. Quick stops, excessive force, and uneven surfaces may cause the product and cart combination to overturn.



14. Disc Tray

Keep your fingers well clear of the disc tray as it is closing. It may cause serious personal injury.

15. Burden

Do not place a heavy object on or step on the product. The object may fall, causing serious personal injury and serious damage to the product.

16. Connecting

When you connect the product to other equipment, turn off the power and unplug all of the equipment from the wall outlet. Failure to do so may cause an electric shock and serious personal injury. Read the owner's manual of the other equipment carefully and follow the instructions when making any connections.

17. Sound Volume

Reduce the volume to the minimum level before you turn on the product. Otherwise, sudden high volume sound may cause hearing or speaker damage.

18. Sound Distortion

Do not allow the product to output distorted sound for a longtime. It may cause speaker overheating and fire.

19. Headphones

When you use the headphones, keep the volume at a moderate level. If you use the headphones continuously with high volume sound, it may cause hearing damage.

20. Laser Beam

Do not look into the opening of the disc tray or ventilation opening of the product to see the source of the laser beam. It may cause sight damage.

21. Disc

Do not use a cracked, deformed, or repaired disc. These discs are easily broken and may cause serious personal injury and product malfunction.

22. Damage Requiring Service

Unplug this product from the wall outlet and refer servicing to qualified service personnel under the following conditions:

- When the power-supply cord or plug is damaged.
- If liquid has been spilled, or objects have fallen into the product.
- If the product has been exposed to rain or water.
- If the product does not operate normally by following the operating instructions. Adjust only those controls that are covered by the operating instructions as an improper adjustment of other controls may result in damage and will often require extensive work by a qualified technician to restore the product to its normal operation.
- If the product has been dropped or damaged in any way.
- When the product exhibits a distinct change in performance-this indicates a need for service.

23. Servicing

Do not attempt to service this product yourself as opening or removing covers may expose you to dangerous voltage or other hazards. Refer all servicing to qualified service personnel.

24. Replacement parts

When replacement parts are required, be sure the service technician has used replacement parts specified by the manufacturer or have the same characteristics as the original part. Unauthorized substitutions may result in fire, electric shock, or other hazards.

25. Safety Check

Upon completion of any service or repairs to this product, ask the service technician to perform safety checks to determine that the product is in proper operating condition.

Table of Contents

Introduction

- ❑ Safety Precautions 2
- ❑ IMPORTANT SAFETY INSTRUCTIONS 3-4
- ❑ Table of Contents 5
- ❑ Precautions 6
- ❑ Notes on Discs 7
- ❑ Identification of Controls 8-11
 - Front Panel/Display Window 8
 - Rear Panel 9
 - Remote Control 10
 - Preparing the Remote Control 11
 - Operating with the Remote Control 11

Connections

- ❑ Connecting to a TV 12
- ❑ Connecting to an Audio System 13
- ❑ Connecting to Optional Audio System 14-16
 - Enjoying Dolby Digital Sound 14
 - Enjoying Dolby Pro Logic Surround Sound 15
 - Enjoying 2 Channel Digital Stereo Sound 16
 - Enjoying DTS Sound 16

Basic Operation

- ❑ Basic Playback 17-19
 - Stopping Play 19
 - Resume Play 19
 - Last Scene Memory 19
 - Screen Saver 19
- ❑ Special Playback 20-21
 - Still Picture 20
 - Frame Advance 20
 - Skipping Chapters and Tracks Forward or Back . 20
 - To Scan at Fast Forward or Fast Reverse Playback . 21
 - Playing in Slow-Motion 21

Operation Using GUI Menu Icons

- ❑ General Information about GUI Menu Icons 22
- ❑ Detailed Description of each GUI Menu Icon . . . 23

Advanced Operation

- ❑ Using a Title Menu 24
- ❑ Using a DVD Menu 24
- ❑ Changing Subtitle Language 25
- ❑ Changing Audio Soundtrack Language 25
- ❑ Viewing from another Angle 26
- ❑ Producing a 3D Surround Effect 26
- ❑ Repeat Play 27
- ❑ Storing Markers in Memory to be Viewed
(Listened to) again 28
- ❑ Zoom Feature 29
- ❑ Random Play 29
- ❑ Program Play 30
- ❑ Playback with MP3 31-32

Initial Settings

- ❑ Selection of Initial Settings 33
- ❑ Selecting Disc Languages 34
- ❑ Selecting Rating Level and Password 35-36
- ❑ Selecting TV Aspect 37
- ❑ Selecting Menu Language 38
- ❑ Setting Remote Control Codes 38
- ❑ Selecting Digital Audio Output 39
- ❑ Others 40
- ❑ Table of Languages and Their Abbreviations . . . 41

Reference

- ❑ Disc Requirements/Copyright Information 42
- ❑ Before Calling Service Personnel 43
- ❑ Specifications 44

Precautions

Notes on handling

- ❑ When shipping the DVD player, always use the original shipping carton and packing materials. For maximum protection, repack the unit as it was originally packed at the factory.
- ❑ Do not use volatile liquids, such as insect spray, near the DVD player. Do not leave rubber or plastic products in contact with the DVD player for a long time. They will leave marks on the finish.
- ❑ The top and rear panels of the DVD player may become warm after a long period of use. This is normal and not a malfunction.
- ❑ When the DVD player is not in use, be sure to remove the disc and turn off the power.
- ❑ If you do not use the DVD player for a long period, the unit may not function properly in the future. Turn on and use the DVD player occasionally.

Notes on Locating

- ❑ When you place this DVD player near a TV, radio, or VCR, the playback picture may become poor and the sound may be distorted. In this case, move the DVD player away from the TV, radio, or VCR.

Notes on Cleaning

Use a soft, dry cloth for cleaning.

- ❑ For stubborn dirt, soak the cloth in a weak detergent solution, wring well and wipe. Use a dry cloth to wipe it dry. Do not use any type of solvent, such as thinner and benzine, as they may damage the surface of the DVD player.
- ❑ If you use a chemical saturated cloth to clean the unit, follow that product's instructions.

Warning: Cleaning and adjustment of lenses and/or other components of playback mechanism should be performed by a qualified service technician.

To Obtain a Clear Picture

The DVD player is a high technology, precision device. If the optical pick-up lens and disc drive parts are dirty or worn down, the picture quality becomes poor. To obtain a clear picture, we recommend regular inspection and maintenance (cleaning or parts replacement) every 1,000 hours of use depending on the operating environment. For details, contact your nearest dealer.

Notes on Moisture Condensation

Moisture condensation damages the DVD player. Please read the following carefully.

Moisture condensation occurs, for example, when you pour a cold drink into a glass on a warm day. Drops of water form on the outside of the glass. In the same way, moisture may condense on the optical pick-up lens inside this unit, one of the most crucial internal parts of the DVD player.

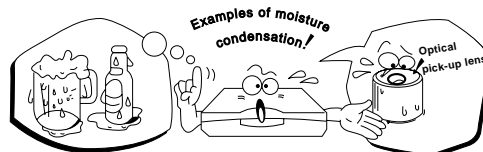

Moisture condensation occurs during the following cases.

- ❑ When you bring the DVD player directly from a cold place to a warm place.
- ❑ When you use the DVD player in a room where you just turned on the heater, or a place where the cold wind from the air conditioner directly hits the unit.
- ❑ In summer, when you use the DVD player in a hot and humid place just after you move the unit from an air conditioned room.
- ❑ When you use the DVD player in a humid place.

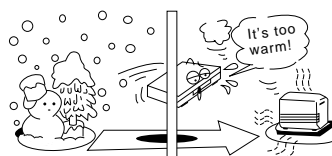

- ❑ **Do not use the DVD player when moisture condensation may occur.**

If you use the DVD player in such a situation, it may damage discs and internal parts. Remove the disc, connect the power cord of the DVD player to the wall outlet, turn on the DVD player and leave it "ON" for two or three hours. After two or three hours, the DVD player will have warmed up and evaporated any moisture. Keep the DVD player connected to the wall outlet and moisture condensation will seldom occur.

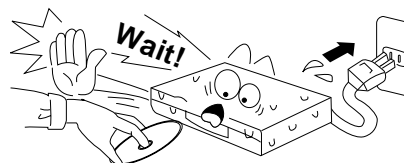

Notes on Discs

This section shows you how to handle, clean, and store discs.

On Handling Discs

- Do not touch the playback side of the disc.

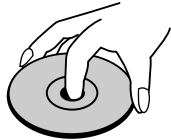

- Do not attach paper or tape to discs.



On Storing Discs

- Do not store discs in a place subject to direct sunlight or near heat sources.
- Do not store discs in places subject to moisture and dust such as a bathroom or near a humidifier.
- Store discs vertically in a case. Stacking or placing objects on discs outside of their case may cause warping.

On Cleaning Discs

- Fingerprints and dust on the disc cause picture and sound deterioration. Wipe the disc from the center outward with a soft cloth. Always keep the disc clean.
- If you cannot wipe off the dust with a soft cloth, wipe the disc lightly with a slightly moistened soft cloth and finish with a dry cloth.
- Do not use any type of solvents such as thinner, benzene, commercially available cleaners or anti-static spray for vinyl LPs. They may damage the disc.

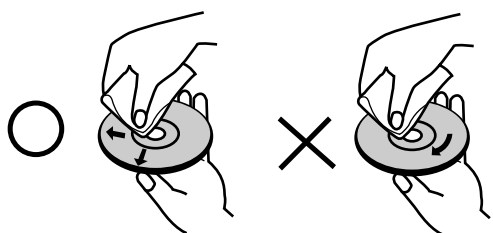

About This Owner's Manual

- This owner's manual explains the basic instructions of this DVD player.
- Some DVD video discs have functions that may not be explained in this owner's manual. Therefore, some instructions may differ from this owner's manual, and there may be extra instructions. In this case, follow the instructions displayed on the TV screen or package.
- "⊗" may appear on the TV screen during operation. This icon means the function explained in this owner's manual is not available on that specific DVD video disc.

Identification of Controls

Front Panel

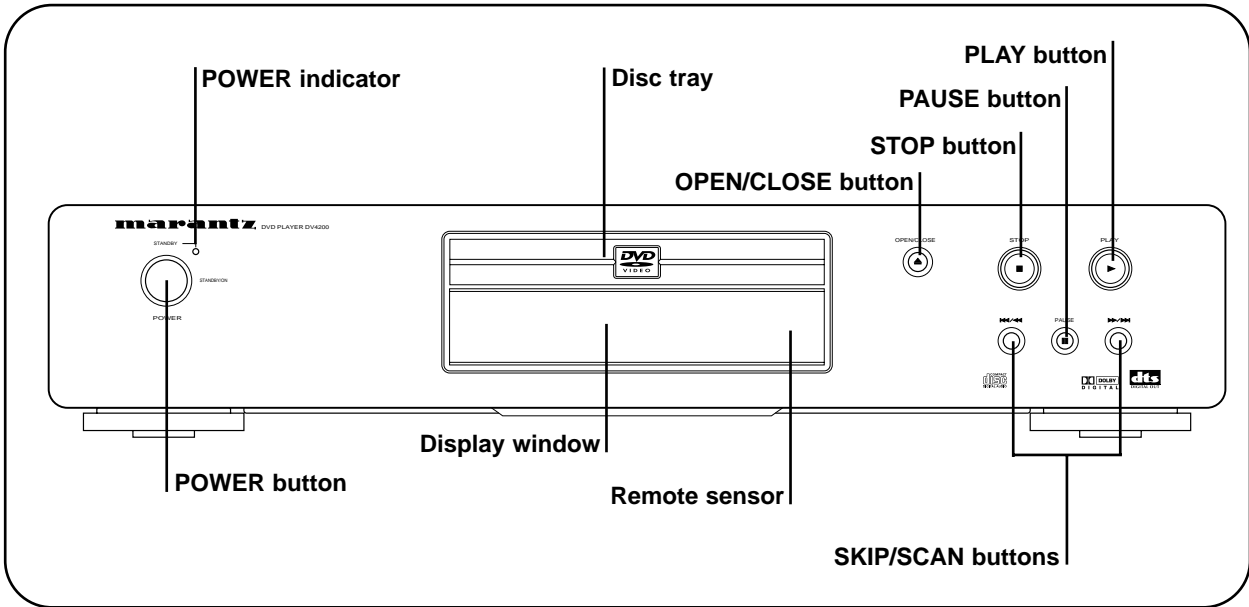

Display Window

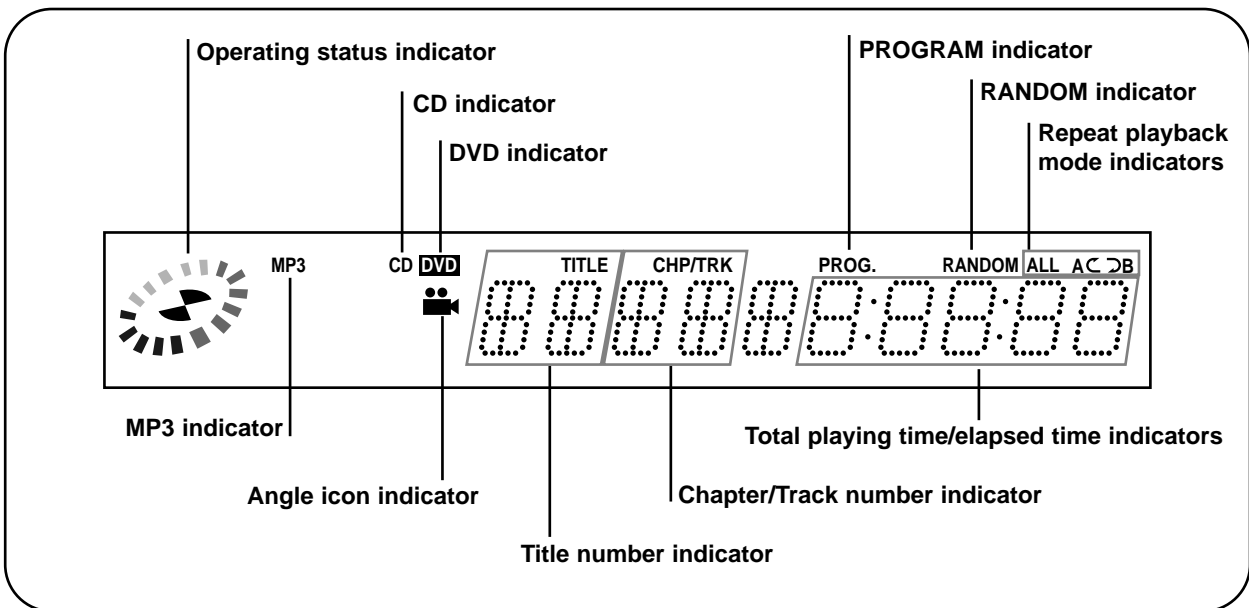

Identification of Controls (Cont'd)

Rear Panel

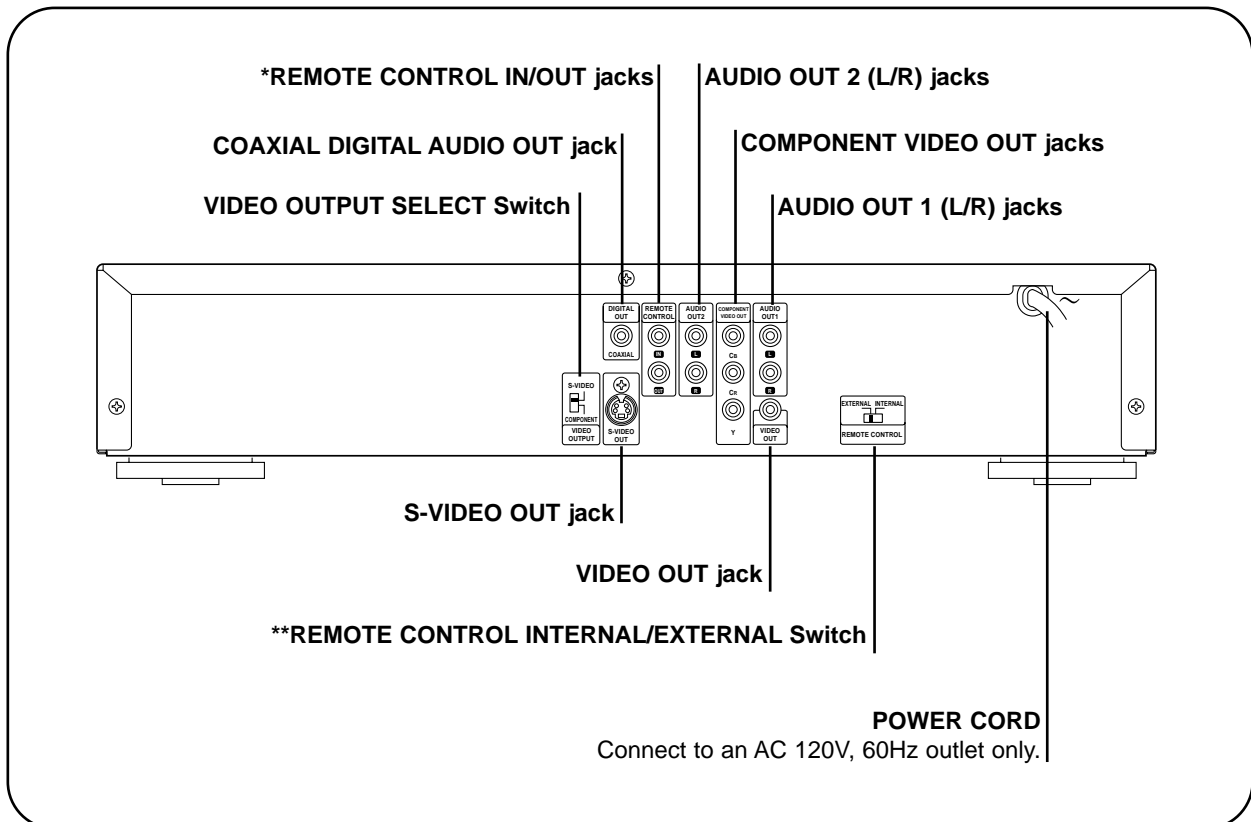

*REMOTE CONTROL IN/OUT jacks

By connecting this DVD player to another Marantz audio component using a supplied System Control cable, you can remotely operate the components as a single system.

- When connecting to component with a remote sensor (such as the SR-14, SR-18, SR-19), be sure to connect the "REMOTE CONTROL IN" jack of this DVD player to the "REMOTE CONTROL OUT" jack of the component with the remote sensor.
- When connecting to component which is not equipped with a remote sensor, be sure to connect the component to the "REMOTE CONTROL OUT" jack of this DVD player.

**Remote switch

- When using this DVD player independently, set this switch to "INTERNAL". When using this DVD player in a system with a Marantz tuner or timer equipped with a remote sensor, set the switch to "EXTERNAL".

Identification of Controls (Cont'd)

REMOTE CONTROL

You will find instructions for each of the remote control functions in the appropriate sections of this instruction manual.

*****TOP MENU button**
Use the TOP MENU button to display the title screen included on DVD video discs. To operate a menu screen, follow the instructions in "Using a Title Menu" (page 24).

***MENU button**
Use the MENU button to display the menu screen included on DVD video discs. To operate a menu screen, follow the instructions in "Using a DVD Menu" (page 24).

**** Directional arrow buttons**
(up, down, left, right) for use in highlighting a selection on a GUI menu screen, TITLE and MENU screen.

- This remote control supports two remote control codes: C1 and C2.
- When the unit is shipped from the factory, the remote control is set to C1.
- To set the remote control to C2, hold down both the STOP button and "2" number button on the remote control for at least five seconds. (If the batteries in the remote control are replaced while the remote control is set to C2, the setting will revert C1.)
- To set the remote control back to C1, hold down both the STOP button and "1" number button on the remote control for at least five seconds.
- Also set the remote control codes of the player to the same setting as the remote control. (This setting is set to C1, when the unit is shipped from the factory.)

Identification of Controls (Cont'd)

Preparing the Remote Control

Insert the batteries into the remote control so you can use it to operate the DVD player.

1 Open the battery cover.



2 Insert batteries (AAA size).

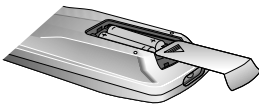

- Make sure to match the + and - on the batteries to the marks inside the battery compartment.

3 Close the cover.

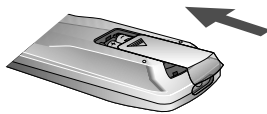

Notes on batteries

- Improper use of batteries may cause battery leakage and corrosion.
- To operate the remote control correctly, follow the instructions.
- Do not insert the batteries into the remote control in the wrong direction.
- Do not charge, heat, open, or short-circuit the batteries. Do not throw the batteries into fire.
- Do not leave dead or exhausted batteries in the remote control.
- Do not use different types of batteries together, or mix old and new batteries.
- If you do not use the remote control for a long period of time, remove the batteries to avoid possible damage from battery corrosion.
- If the remote control does not function correctly or if the operating range becomes reduced, replace all batteries with new ones.
- If battery leakage occurs, wipe the battery liquid from the battery compartment, then insert new batteries.
- The batteries should last about one year with normal use.

Operating with the Remote Control

This section shows you how to use the remote control.

Point the remote control at the remote sensor and press the buttons.

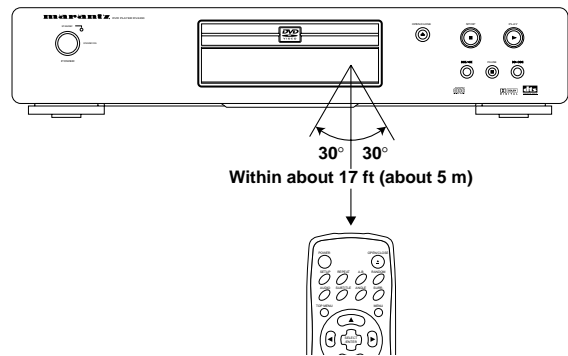

Distance: About 17 ft (5 m) from the front of the remote sensor

Angle: About 30° in each direction of the front of the remote sensor

- * Do not expose the remote sensor of the DVD player to a strong light source such as direct sunlight or illumination. If you do so, you may not be able to operate the DVD player with the remote control.

Notes on the remote control

- Point the remote control at the remote sensor on the DVD player.
- Do not drop or give the remote control a shock.
- Do not leave the remote control near an extremely hot or humid place.
- Do not spill water or put anything wet on the remote control.
- Do not disassemble the remote control.

Connecting to a TV

Connect the DVD player to your TV.

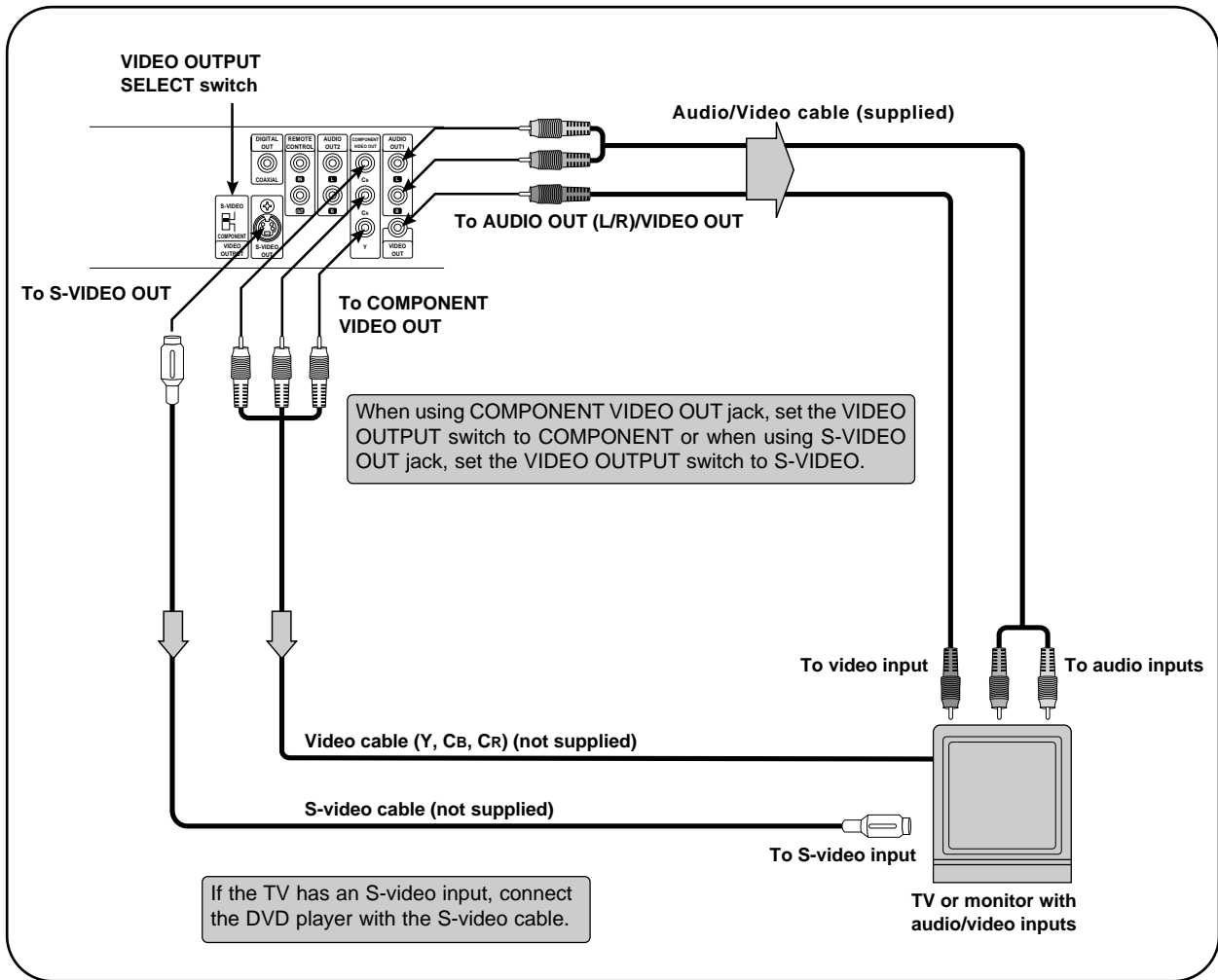

Notes

- Refer to the owner's manual of your TV as well.
- Before you connect the DVD player to your TV, be sure to turn off the power and unplug both units from the wall outlet before making any connections.
- Connect the DVD player to your TV directly. If you connect the DVD player to a VCR, the playback picture will be distorted because DVD video discs are copy protected.

⚠ Warning

Do not set the Digital Audio Output of this DVD player to "Dolby Digital" unless you are connecting the DIGITAL OUT jack of this DVD player to an AV decoder that has the Dolby Digital decoding function. High volume sound may damage your hearing as well as the speakers (Refer to "Selecting Digital Audio Output" on page 39).

Connecting to an Audio System

You can listen to the sound of audio CDs and DVD video discs in stereo.

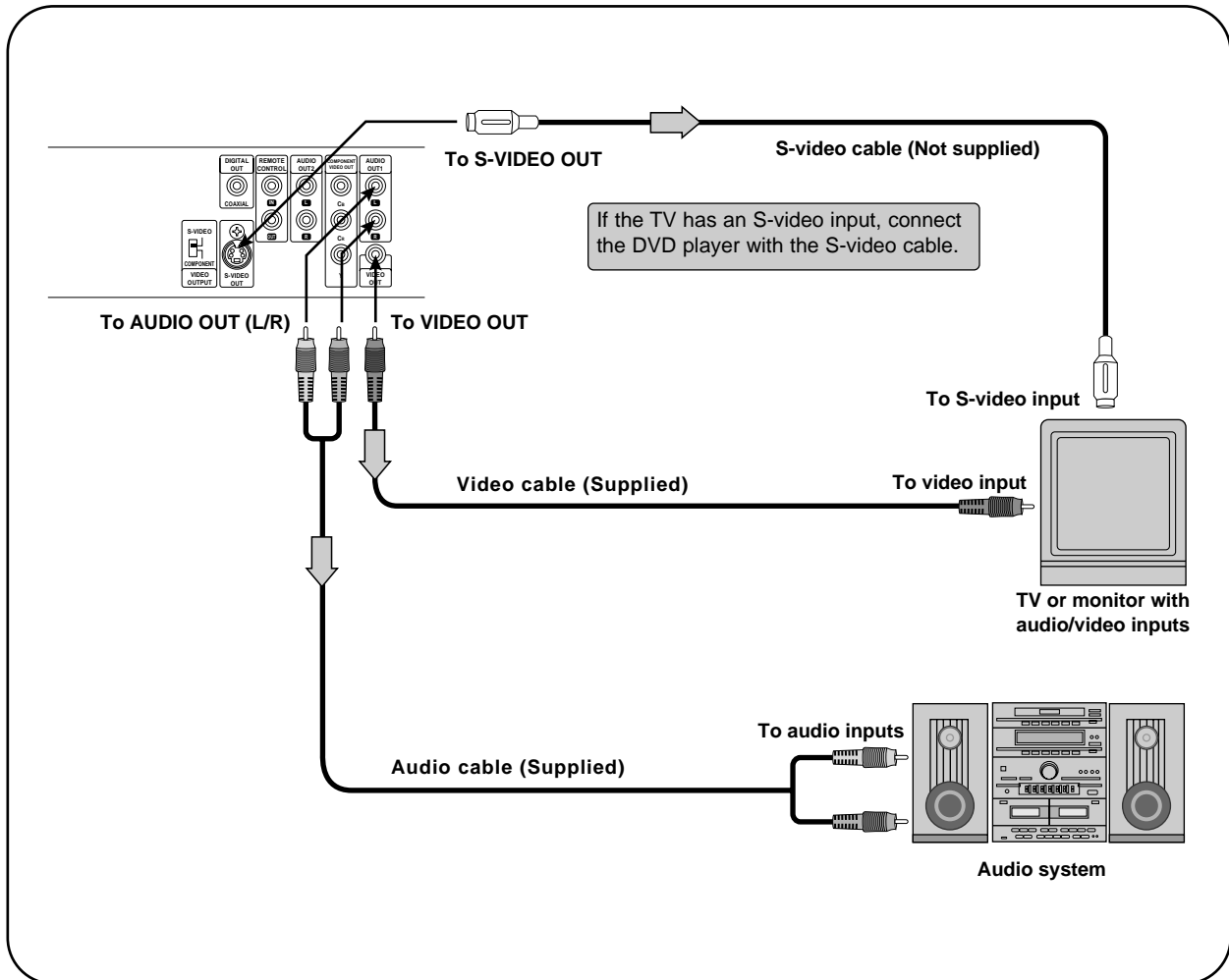

Notes

- Refer to the owner's manual of your audio system as well.
- Before you connect the DVD player to other equipment, be sure to turn off the power and unplug all of the equipment from the wall outlet before making any connections.
- If you place the DVD player near a tuner or radio, the radio broadcast sound might be distorted. In this case, move the DVD player away from the tuner and radio.
- The output sound of the DVD player has a wide dynamic range. Be sure to adjust the receiver's volume to a moderate listening level. Otherwise, the speakers may be damaged by a sudden high volume sound.
- Turn off the receiver before you connect or disconnect the DVD player's power cord. If you leave the receiver power on, the speakers may be damaged.

⚠ Warning

Do not set the Digital Audio Output of this DVD player to "Dolby Digital" unless you are connecting the DIGITAL OUT jack of this DVD player to an AV decoder that has the Dolby Digital decoding function. High volume sound may damage your hearing as well as the speakers (Refer to "Selecting Digital Audio Output" on page 39).

Connecting to Optional Audio System

Enjoying Dolby Digital Sound

You can enjoy the high quality dynamic sound of Dolby Digital, Dolby Pro Logic, and 2 Channel Digital Stereo.

Dolby Digital

Dolby Digital is the surround sound technology used in theatres showing the latest movies, and is now available to reproduce this realistic effect in the home. You can enjoy motion picture and live concert DVD video discs with this dynamic realistic sound by connecting the DVD player to a 6 channel receiver equipped with a Dolby Digital decoder or Dolby Digital processor.

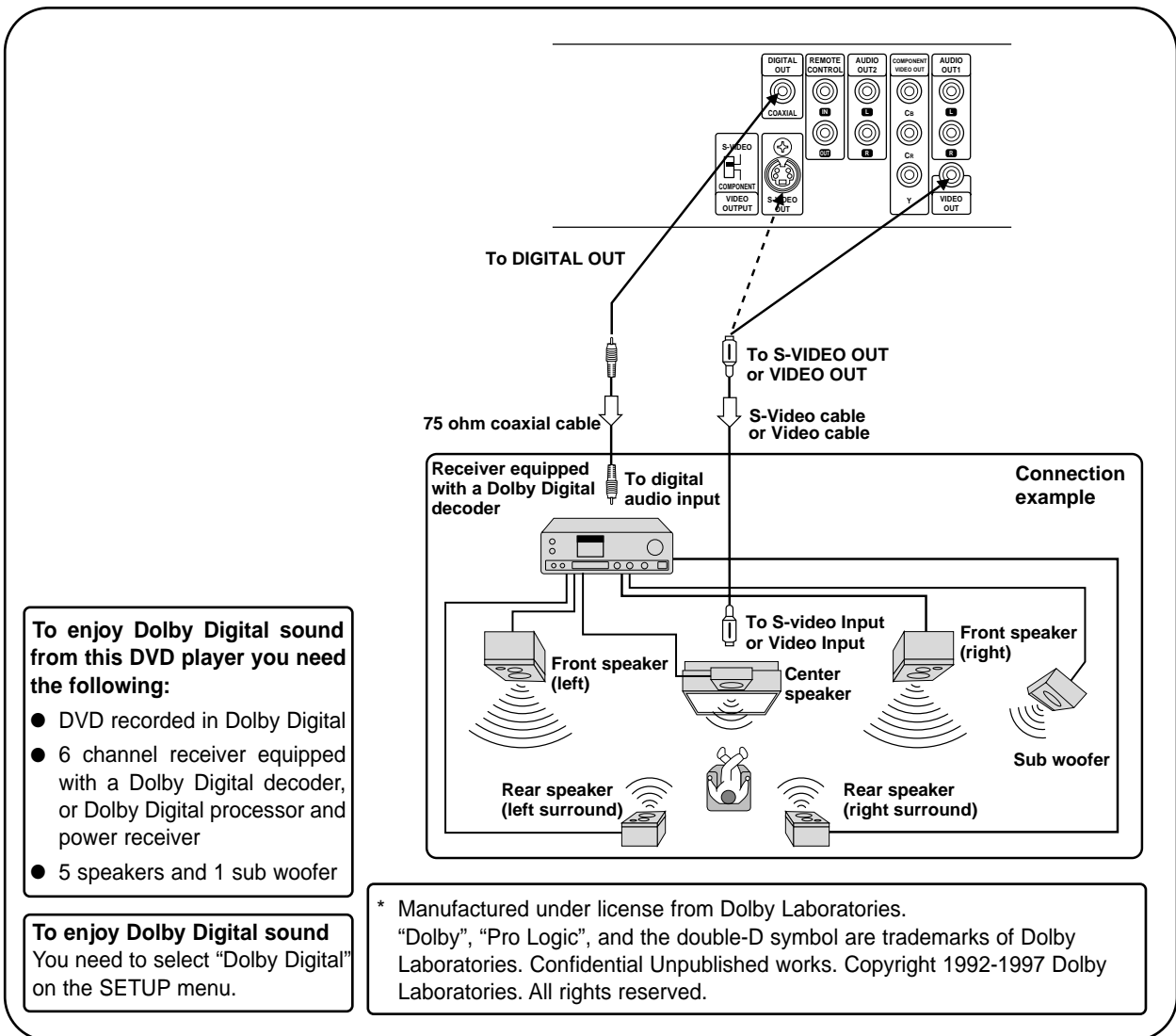

Notes

- Refer to the owner's manual of your audio equipment as well.
- Before you connect the DVD player to other equipment, be sure to turn off the power and unplug all of the equipment from the wall outlet before making any connections.
- The output sound of the DVD player has a wide dynamic range. Be sure to adjust the receiver's volume to a moderate listening level. Otherwise, the speakers may be damaged by a sudden high volume sound.
- Turn off the receiver before you connect or disconnect the DVD player's power cord. If you leave the receiver power on, the speakers may be damaged.

Connecting to Optional Audio System (Cont'd)

Enjoying Dolby Pro Logic Surround Sound

Dolby Pro Logic Surround

You can still enjoy the excitement of Surround Sound even if your A/V receiver does not offer Dolby Digital decoding. If your A/V receiver has a Dolby Pro Logic decoder, refer to the following connection diagram.

Connect one or two rear speakers. The output sound from the rear speakers will be monaural even if you connect two rear speakers.

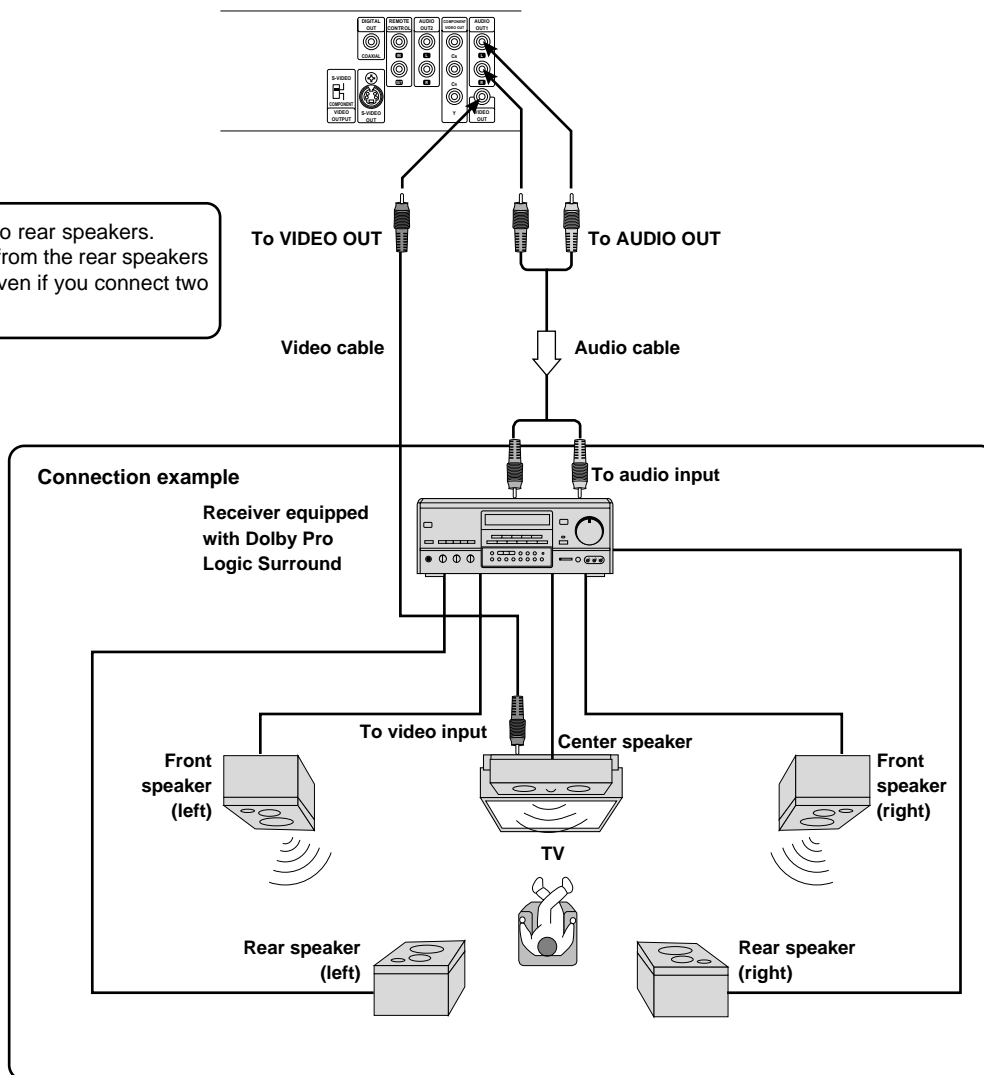

- **With a receiver equipped with Dolby Digital**
Connect the equipment the same way as described in "Enjoying Dolby Digital Sound" on the previous page. Refer to that receiver's owner's manual and set the receiver so you can enjoy Dolby Pro Logic Surround sound.

Warning

Do not set the Digital Audio Output of this DVD player to "Dolby Digital" unless you are connecting the DIGITAL OUT jack of this DVD player to an AV decoder that has the Dolby Digital decoding function. High volume sound may damage your hearing as well as the speakers (Refer to "Selecting Digital Audio Output" on page 39).

Connecting to Optional Audio System (Cont'd)

Enjoying 2 Channel Digital Stereo Sound

2 Channel Digital Stereo

You can enjoy the dynamic sound of 2 Channel Digital Stereo by connecting this DVD player to a receiver equipped with a digital audio input and speaker system (right and left front speakers).

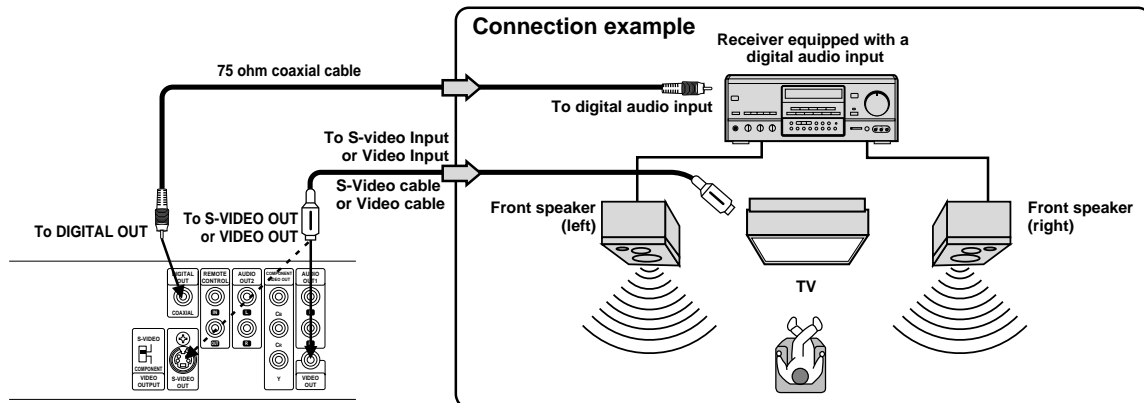

Enjoying DTS Sound

Introducing DTS Digital Surround™...the finest technology ever invented to transform existing "home theatre" systems into six discrete channels of exceptionally clear, better-than-compact disc, digital audio performance. And DTS Digital Surround is the only 5.1 surround sound format that can deliver this revolutionary 3-dimensional experience through new music recordings on compact discs, original 5.1 soundtracks on motion picture laserdiscs, and soon, a wide variety of products on DVD.

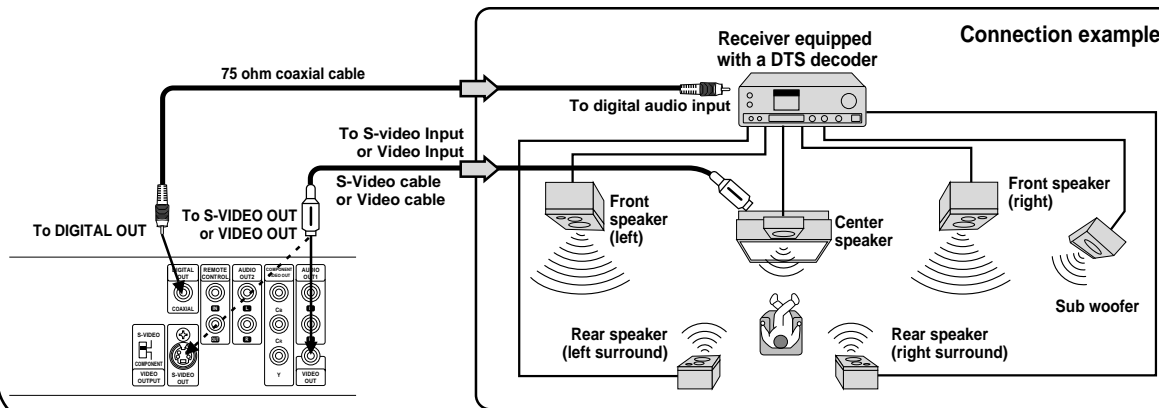

"DTS" and "DTS Digital Out" are trademarks of Digital Theater Systems, Inc.

Notes

- Refer to the owner's manual of your receiver as well.
- Before you connect the DVD player to other equipment, be sure to turn off the power and unplug all of the equipment from the wall outlet before making any connections.
- The output sound of the DVD player has a wide dynamic range. Be sure to adjust the receiver's volume to a moderate listening level. Otherwise, the speakers may be damaged by a sudden high volume sound.
- Turn off the receiver before you connect or disconnect the DVD player's power cord. If you leave the receiver power on, the speakers may be damaged.
- When playing DTS-encoded discs (DVD video discs and audio CDs), excessive noise may be output from the analog stereo jacks. To avoid possible damage to the audio system, you should take proper precautions when the AUDIO OUT jacks of the DVD video player is connected to an amplification system. To enjoy DTS Digital Surround playback, an external 5.1 channel DTS Digital Surround decoder system must be connected to the DIGITAL OUT jack of the DVD video player.

Basic Playback



This section shows you the basics on how to play back a DVD video disc.

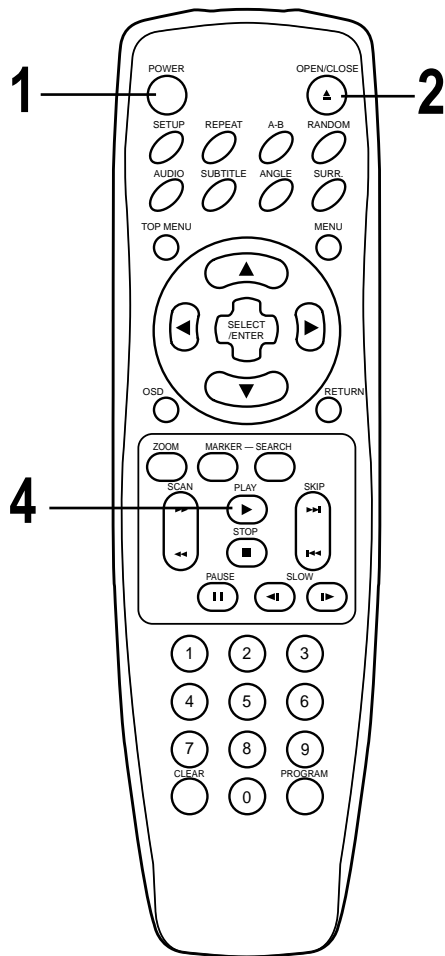
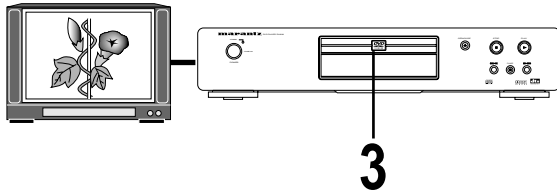

Preparations

- When you want to play back DVD video discs, turn on the TV and select the video input source connected to the DVD player.
- When you want to enjoy the sound of DVD video discs or audio CDs from the audio system, turn on the audio system and select the input source connected to the DVD player.
- For connection details, see pages 12 through 16.
- Set the playback picture size according to the aspect ratio of the connected TV via the SETUP menu (TV Aspect).
- If you do not have the necessary equipment to enjoy Dolby Digital sound, set the Digital Audio Output (via the SETUP menu) to "PCM".

1 Press POWER.

The DVD player turns on and the power indicator lights.

2 Press OPEN/CLOSE.

The disc tray opens.

- You can open the disc tray by pressing this button even if the DVD player is in standby mode.

3 Place a disc on the disc tray with the playback side down.

- There are two different disc sizes. Place the disc in the correct guide on the disc tray. If the disc is out of the guide, it may damage the disc and cause the DVD player to malfunction.
- Do not place anything except 3" discs or 5" discs on the disc tray.

4 Press PLAY.

The disc tray is automatically closed and playback begins.

- If the disc is placed in upside down (and it is a single sided disc), "NO DISC" or "DISC ERROR" appears on the TV screen.

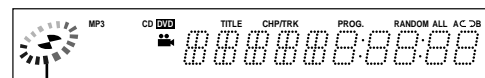

Operating status indicator

- If you insert an audio CD, the CD indicator lights up on the display. The title number does not appear.
- After playing back all of the chapters in the title, the DVD player automatically stops and returns to the menu screen.

When a menu screen appears on the TV screen.

In case of interactive DVDs with control, a menu screen appears on the TV screen. Perform step 5 on page 18 to start play.

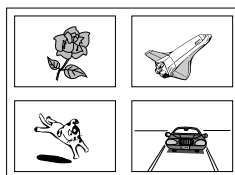

Example of interactive DVD On-Screen Menu

Basic Playback (Cont'd)



5 Press ▲/▼/◀▶ and press SELECT/ENTER, or press the numeric button(s), to select the desired item.
Playback of the selected item begins.

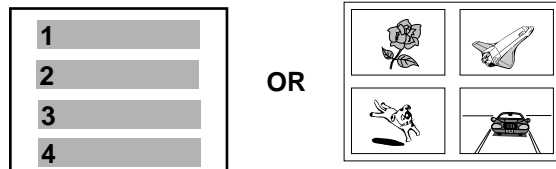
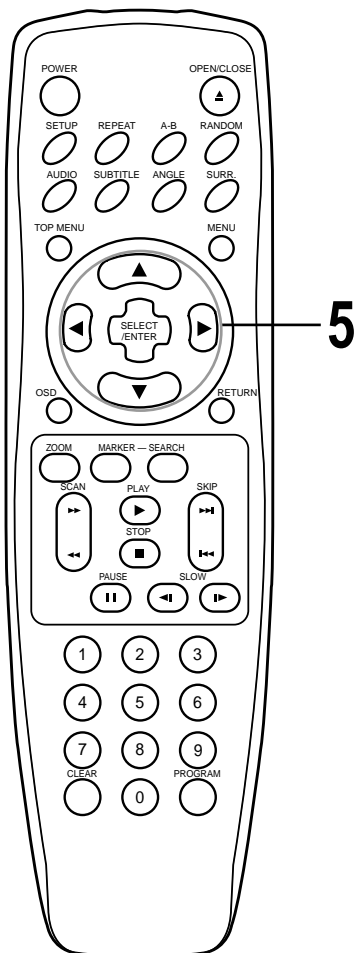

Example of interactive DVD On-Screen Menu

- For further information, refer to the disc jacket of the disc you are playing.

After operation

When the unit is not in use, remove the disc and press POWER to turn off the DVD player.

Notes

- Do not move the DVD player during playback. Doing so may damage the disc and the DVD player.
- Use the OPEN/CLOSE button on the remote control or DVD player to open and close the disc tray. Do not push the disc tray while it is moving. Doing so may cause the DVD player to malfunction.
- Do not push up the disc tray or put any objects other than discs on the disc tray. Doing so may cause the DVD video player to malfunction.
- Keep your fingers well clear of the disc tray as it is closing. Be especially careful with children's fingers around the closing disc tray as there is a risk of personal injury.
- When "⊘" appears on the TV screen while a button is pressed, it means that this function is not available on the disc you are playing.
- Depending on the DVD disc, some operations may be different or restricted. Refer to the jacket or case of the disc you are playing.

Basic Playback (Cont'd)

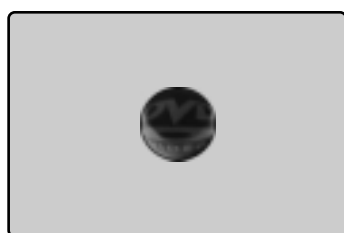
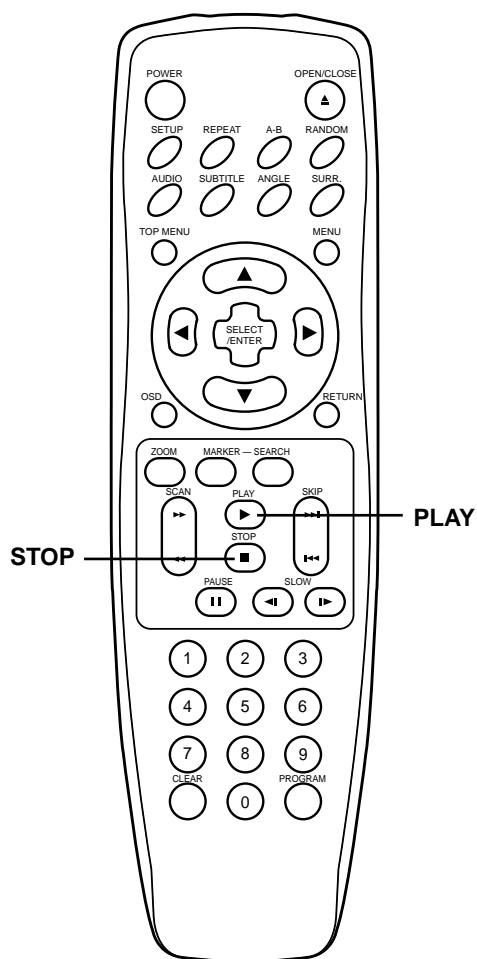

Screen Saver

Stopping Play

Press **STOP** during playback.

Resume Play

- When play is stopped, the unit records the point where **STOP** was pressed (**RESUME** function). Press **PLAY** and play will resume from this point.

Notes

- This operation works only with discs for which the elapsed playing time appears in the DVD display window during stop.
- Resume function will be cleared when the **STOP** is pressed on the **STOP** mode.
- The Resume function may not be available on some DVD discs.

Last Scene Memory

This player memorizes last scene for the last disc you have watched. Settings remain in memory even if you remove the disc from the player or switch off the player. If you load a disc that has its settings memorized, Latest Stop Position is automatically recalled.

Notes

- Settings are stored in memory for use any time.
- Switching of the audio mode, etc., is automatic on some discs.
- This player does not memorize if you switch off the player when a DVD or title menu appears on the TV screen.
- The last scene memory function will be cleared when the **STOP** is pressed on the **STOP** mode.

Screen Saver

The screen saver is useful to prevent your display from becoming damaged.

The screen saver picture appears when you leave the DVD player in stop mode for about 5 minutes.

Automatic power off function

After the Screen Saver has been engaged for about 5 minutes, the DVD player will automatically turn itself off.

Special Playback



Still Picture (Pause)

Press PAUSE during playback.

- DVD
The player will be placed in the still picture mode.
- CD
The player will be placed in the pause mode.

Frame Advance (DVD only)

Press PAUSE during still playback.

(Each time you press PAUSE, the picture advances one frame)

To resume normal playback, press PLAY.

Skipping Chapters and Tracks Forward or Back

Skipping forward

Press SKIP ►► during playback.

A chapter (DVD) or a track (CD) is skipped each time the button is pressed.

Skipping back

Press SKIP ◄◄ during playback.

- When the button is pressed once midway through a chapter/track, the player returns to the start of that chapter/track. When it is pressed again, a chapter/track is skipped each time the button is pressed.

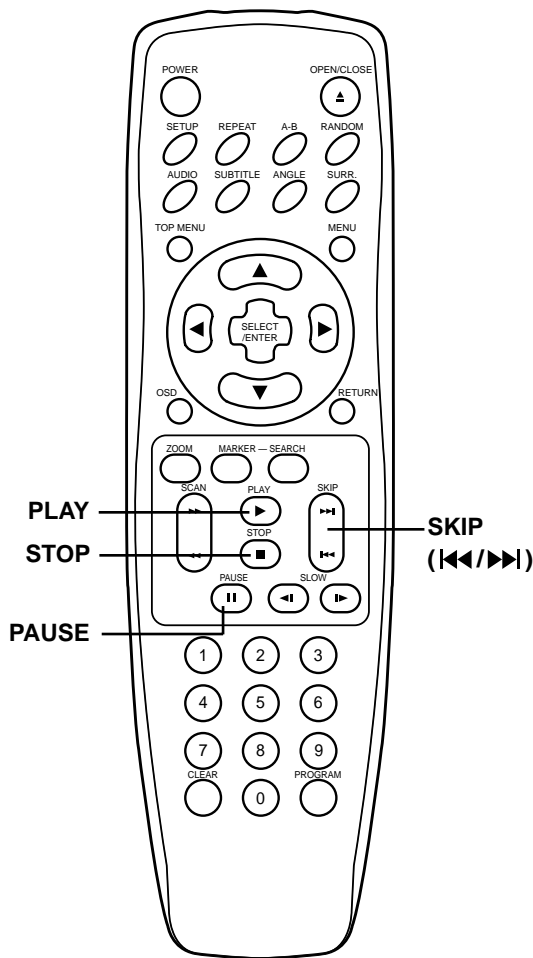

Special Playback (Cont'd)



You can play back discs at various speeds.

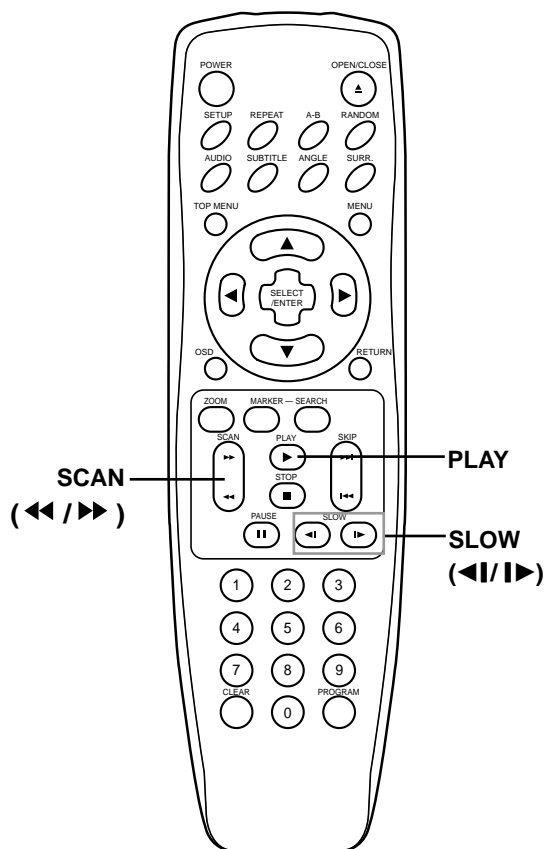

To Scan at Fast Forward or Fast Reverse Playback.

Press the **SCAN** **◀◀** or **▶▶** button during playback.

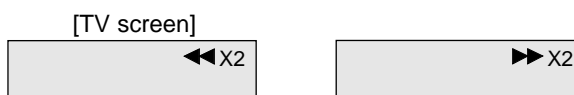

- The speed of advance (reverse) is relatively slow at first. When the button is pressed again, the speed becomes faster. (Each time the button is pressed, the speed increases up to 4 steps (DVD) or 3 steps (CD).)
- The speed will be retained even after the button is released.

To return to normal playback, press **PLAY**.

Note

- The DVD player does not play back sound during the high speed reverse and forward playback of DVD video discs. However, the DVD player plays back sound during fast forward or fast reverse playback of audio CDs.
- Subtitles do not appear on the screen during scan playback.

Playing in Slow-Motion (DVD only)

Press **SLOW** **◀|** or **|▶** during playback.

The playback speed becomes 1/16 (DVD) of the normal speed.

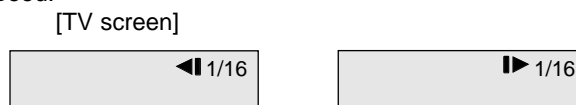

- The speed of slow-motion is slow at first. When the button is pressed again, the speed becomes faster. (Each time the button is pressed, the speed increase up to 4 steps.)
- The speed will be retained even after the button is released.

To return to normal playback, press **PLAY**.

Notes

- The sound is muted during slow-motion playback.
- The DVD player can not play back Audio CDs in slow motion.

General Information about GUI Menu Icons



This unit features GUI Menu Icons showing disc information (title/chapter/track number, elapsed playing time, audio/subtitle language, angle, and sound) and player information (repeat play, play mode, marker, etc.). Some icons only show the indicated information. Other icons allow the settings to be changed.

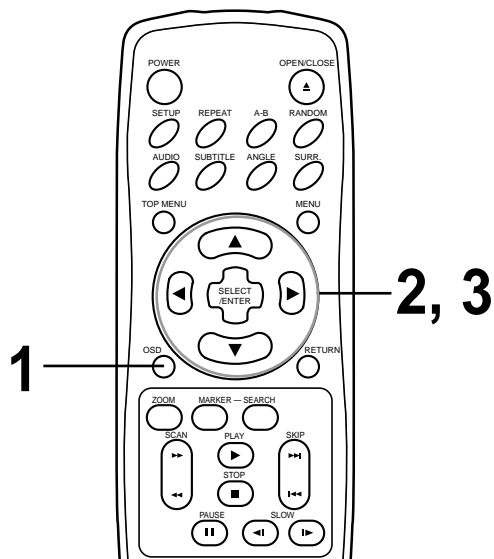

Common procedures

- 1** Press OSD during playback.
 - Title function can be accessed from the stop mode.
- 2** Press ▲/▼ to select the desired item.
 - The current selected item is indicated by a yellow frame on its GUI menu icons.
- 3** Press ◀▶ to select the desired setting.
 - When numbers are displayed (e.g. title number), the numeric buttons can also be used for setting instead of ◀▶.
 - For some functions, the setting will be registered immediately; for others, SELECT/ENTER must be pressed.

To clear the GUI Menu Icons, press OSD again.

Examples of GUI Menu Icons.
(The screens may differ depending on the disc contents.)



(DVD GUI)



(CD GUI)



(DVD and CD GUI)

Detailed Description of each GUI Menu Icon



You can view information about a disc and its operational status on the TV screen.

Press OSD during playback.
[TV screen] DVD GUI



FUNCTION (Press ▲/▼ to select desired item)	SELECTION METHOD
To show the current title number and to jump to the desired title number	◀▶, or Numeric SELECT/ENTER
To show the current chapter number and to jump to the desired chapter number	◀▶, or Numeric SELECT/ENTER SKIP
To show the elapsed time and directly select scenes by the desired time.	Numeric SELECT/ENTER
To show the current audio soundtrack language, encoding method, channel number and to change the settings.	◀▶, AUDIO
To show the current subtitles language and to change the setting.	◀▶, SUBTITLE
To show the current angle number and to change the angle.	◀▶, ANGLE
To show the current sound (NORMAL or 3D SURROUND) and to change the setting.	◀▶, SURR.

Press OSD during playback.
[TV screen] CD GUI



FUNCTION (Press ▲/▼ to select desired item)	SELECTION METHOD
To show the current track number and to jump to the desired track number	◀▶, or Numeric SELECT/ENTER SKIP
To show the elapsed time. (Display only)	—
To show the current audio (STEREO, LEFT, RIGHT) and to select to the desired audio channel.	◀▶, AUDIO
To show the current sound (NORMAL or 3D SURROUND) and to change the setting (Audio CD only).	◀▶, SURR.

Note

- Some DVD discs may not provide all of the above GUI menu icons.

Using a Title Menu



Some movie discs may contain two or more titles. If the disc has a title menu recorded on it, the TOP MENU button can be used to select the movie title. (The details of operation differ depending on the disc used.)

- Selecting a title may not be possible on certain DVD discs.

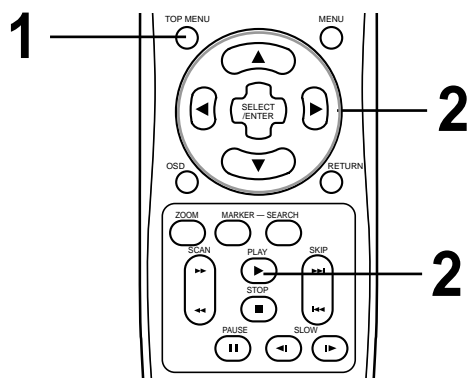

1 Press TOP MENU.

A list of the titles on the disc is displayed.

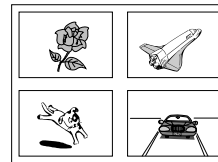

Pressing TOP MENU again to resume play from the scene when TOP MENU was first pressed.

- Resume play may not be possible on certain discs.

2 Press ▲/▼/◀/▶ and press SELECT/ENTER or PLAY, or press the numeric button(s), to select desired title.

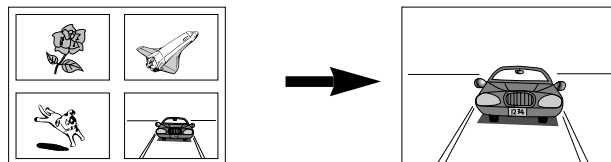

The selected title now starts playing.

Using a DVD Menu



Some DVDs have unique menu structures called DVD menus. For example, DVDs programmed with complex contents provide guide menus, and those recorded with various languages provide menus for audio and subtitle language. Although the DVD menu's contents and operation differ from disc to disc, the following explains the basic operation when this feature is used.

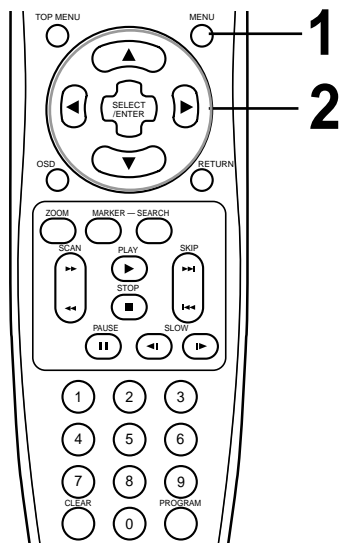

1 Press MENU during play.

The DVD menu available on the disc is now displayed.

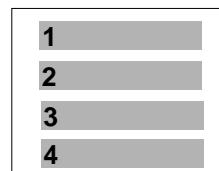

Pressing MENU again resumes play from the scene when MENU was first pressed.

- Resume play may not be possible on certain discs.

2 Press ▲/▼/◀/▶ and press SELECT/ENTER, or press the numeric button(s), to select desired item.

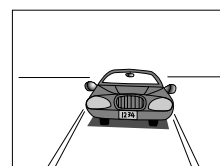

The selected item is now executed.

Changing Subtitle Language



It is possible to change the subtitle language to a different language from the one selected at the initial settings. (See page 34 for further info.)

This operation works only with discs on which multiple subtitle languages are recorded.

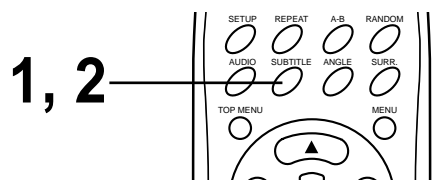

1 Press SUBTITLE during playback.

When no subtitles are recorded, "OFF" will be displayed instead of the language number.



2 Press SUBTITLE repeatedly until the desired language is selected.

Number of the subtitle language being played back is shown.



Notes

- In some cases, the subtitle language is not changed to the selected one immediately.
- When a disc supporting the closed caption is played, the subtitle and the closed caption may overlap each other on the TV screen. In this case, turn the subtitle off.
- When the desired language is not selected even after pressing the button several times, it means that the language is not available on the disc.
- When the power is turned on or the disc is removed, subtitles appears in the language selected at the initial settings. If this language is not recorded on the disc, the disc's priority language appears.

To eliminate the On Screen Subtitles.

Press SUBTITLE repeatedly to select OFF at step 2.

Changing Audio Soundtrack Language



It is possible to change the audio soundtrack language (or encoding method, channel number) to a different language from the one selected at the initial settings in case of DVD disc. (See page 34 for further info.) This operation works only with discs on which multiple audio soundtrack languages are recorded.

And it is possible to change the audio channel in case of audio CD.

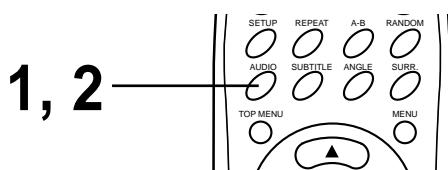

• DVD

1 Press AUDIO during play.

Number of the audio soundtrack language being played back.



2 Press AUDIO repeatedly until the desired language (or encoding method, channel number) is selected.



• CD

1 Press AUDIO during play.



2 Press AUDIO repeatedly until the desired sound is selected.



Notes

- When the desired language is not selected even after pressing the button several times, it means that the language is not available on the disc.
- When the power is turned on or the disc is removed, the language heard is the one selected at the initial settings. If this language is not recorded on the disc, only the available language on the disc will be heard.
- Some discs may not respond to Audio feature.

Viewing from another Angle



Some DVDs may contain scenes which have been shot simultaneously from a number of different angles. For these discs, the same scene can be viewed from each of these different angles using the ANGLE button. (The recorded angles differ depending on the disc used.)

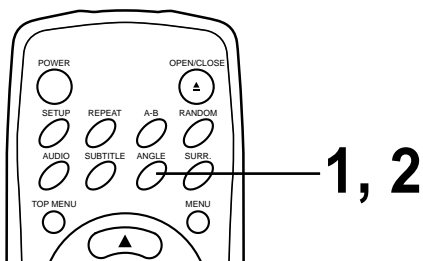
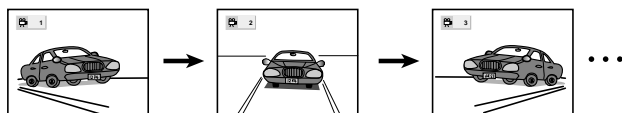

1 Press ANGLE during playback.

Number of angle being played back.



2 Press ANGLE repeatedly until the desired angle is selected.



For your reference

- The ANGLE indicator will blink in the DVD display window at scenes recorded at different angles to indicate that angle switching is possible.
- The angle number can be programmed beforehand; the angle will be switched to the selected number when the ANGLE indicator blinks.

Note

- This function only works for discs having scenes recorded at different angles.

Producing a 3D Surround Effect



This unit can produce a 3D Surround effect, using 3D Surround Sound technology, which simulates multi-channel audio playback from two conventional stereo speakers instead of the five or more speakers normally required to listen to multi-channel audio from a home theatre. This feature works with DVD discs encoded with Dolby Pro Logic and Dolby Digital audio tracks.

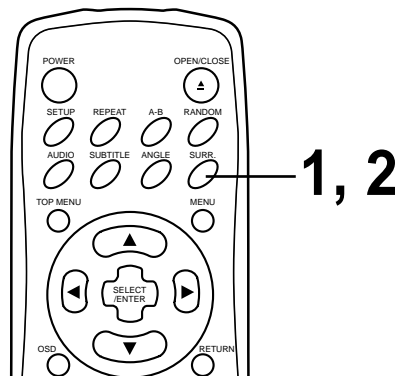

1 Press SURR. during playback.

Each time this button is pressed, the TV screen display changes.



2 Press SURR. repeatedly until the desired sound is selected.



Notes

- This 3D Surround effect may not be available on some DVD discs, such as those recorded with a mono audio soundtrack.
- Turn off the TV surround sound and other surround effects when using this 3D surround effect.
- For best 3D Surround effect using only two speakers it is recommended that the two speakers be positioned approximately 8' to 10' apart, and the listening position should be 8' to 10' away from the speakers.

Repeat Play



Repeating viewing (listening)

Press REPEAT during playback.

Each time this button is pressed, the TV screen changes as shown below and the disc will repeat a chapter or title (DVD) or a track (CD).

• DVD

Repeat of chapter being played

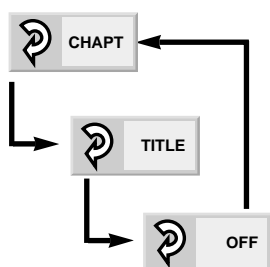

Repeat of title being played

Cancel repeat mode (normal play)

• CD

Repeat of track being played

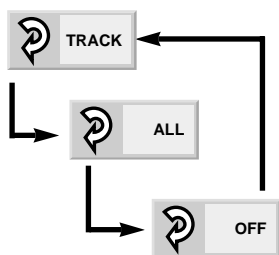

Repeat of entire disc contents

Cancel repeat mode (normal play)

To enjoy program repeat play (CD)

If REPEAT is pressed during program play, repeat play is operated as below.

Repeat of the current programmed track

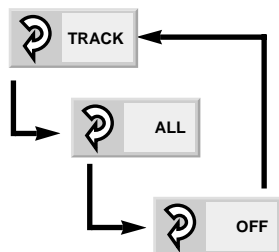

Repeat of all programs

Cancel repeat mode (Program play)

To return to normal play

Press REPEAT several times until "OFF" is displayed.

Repeating sections between two specific points (A-B repeat)

1 Press A-B during play at the point where repeat play is to start (A).



- You can select "OFF" at this step by pressing CLEAR.

2 Press A-B during play at the point where repeat play is to be concluded (B).



Repeat play of the selection between points A and B starts.

To return to normal play

Press A-B once "OFF" is displayed.



Notes

- Repeat play works only with discs for which the elapsed playing time appears in the DVD display window during playback.
- Repeat play may not work correctly with some DVDs.
- A-B repeat play works only within a title DVD or a track CD.
- Some subtitles recorded around point A or B may fail to appear (DVD).

Storing Markers in Memory to be Viewed (Listened to) again



Storing a MARKER in the DVD memory is similar to marking your page in a book. It allows you to quickly return to any point on the disc.

Storing a marker in the memory

- 1 Press **MARKER** during play at the starting point to be viewed (listened to) again.



Indicates "1/9" is stored in the memory. Up to 9 marks can be stored in the memory.

Recalling/Clearing a marker

- 2 Press **SEARCH** during playback. The **MARKER SEARCH** menu will appear on the TV screen.



- 3 Press **◀▶** to select the marker to be recalled/cleared.

- 4 Press **SELECT/ENTER** to recall a marker. Or press **CLEAR** to clear a marker.

Play resumes from the point corresponding to the selected marker, or the selected marker is cleared.

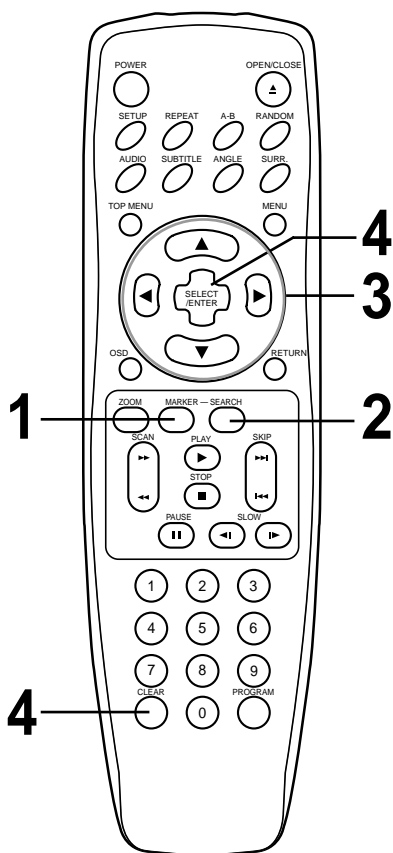

Notes

- These operations work only with discs for which the elapsed playing time appears in the DVD display window during playback or stop.
- Some subtitles recorded around the marker may fail to appear (DVD).
- All the markers are cleared when the power is turned off or the disc is removed.
- The marker is not stored when the DVD or title menu is displayed on the TV screen.

Zoom Feature



The Zoom function allows you to enlarge the video image and to move through the enlarged image.

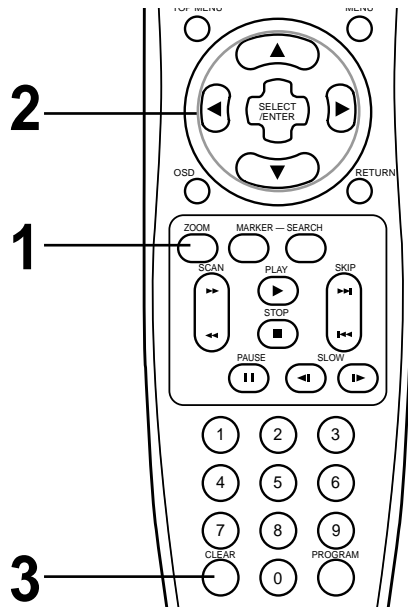

- 1 Press ZOOM during playback or still playback to activate the Zoom function.**
If you further press ZOOM repeatedly, the magnification level increases (6 steps).
- 2 Press ▲/▼/◀▶ buttons to move through the zoomed picture.**
- 3 Press CLEAR to resume normal playback.**

Notes

- Some discs may not respond to the Zoom feature.
- Zoom does not work on subtitles or menus included on DVD video discs.

Random Play



Note: This function only works with karaoke DVD and Audio CD. Random does not work with DVD movie discs.

You can playback titles or tracks in random order. (Random playback)
The DVD player automatically selects the titles on a DVD video karaoke disc only and plays them back randomly.

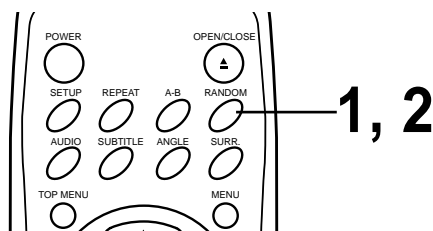

Random play (Karaoke DVD or CD)

- 1 Press RANDOM during normal playback or stop mode.**
The DVD player automatically starts random playback and the RANDOM indicator in the DVD display window appears.
- 2 To resume normal playback, press RANDOM.**
The RANDOM indicator in the DVD display window disappears.

Notes

- Random playback may not be possible on certain discs.
- If you press the SKIP ◀◀ or ▶▶ button during random playback, the DVD player goes to another track randomly and starts playback.

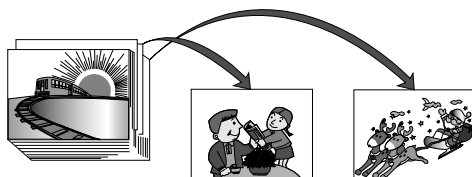

Program Play



The player plays the tracks on the disc in the order you specify.

Note: Program play function is possible only with audio CDs. It does not work with DVD movie discs.

- 1 Press PROGRAM on the stop mode.**
The program playback screen appears on the TV screen.

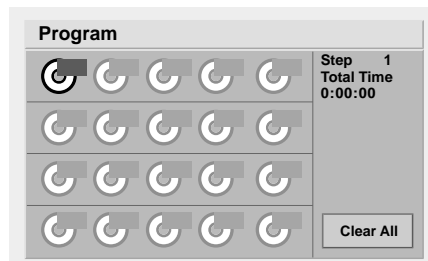

- To exit the screen, press PROGRAM or RETURN.

- 2 Press ▲/▼/◀/▶ and press the numeric button(s), to select the desired track number.**



- Repeat step 2 to select another track.
- Up to 20 tracks can be programmed.

- 3 Press PLAY to exit the screen.**
The selected track is stored in the memory and play now begins in the programmed sequence.

After playback of all tracks programmed
Play is stopped.

Clearing the program

- To clear the programmed tracks one by one**

Press ▲/▼/◀/▶ to select the unwanted number and then press CLEAR.

- To clear all the programmed tracks**

Press ▲/▼/◀/▶ to select "Clear All" and then press SELECT/ENTER. Press PROGRAM or RETURN to exit the screen. (The programs are also cleared when the power is turned off or the disc is removed.)

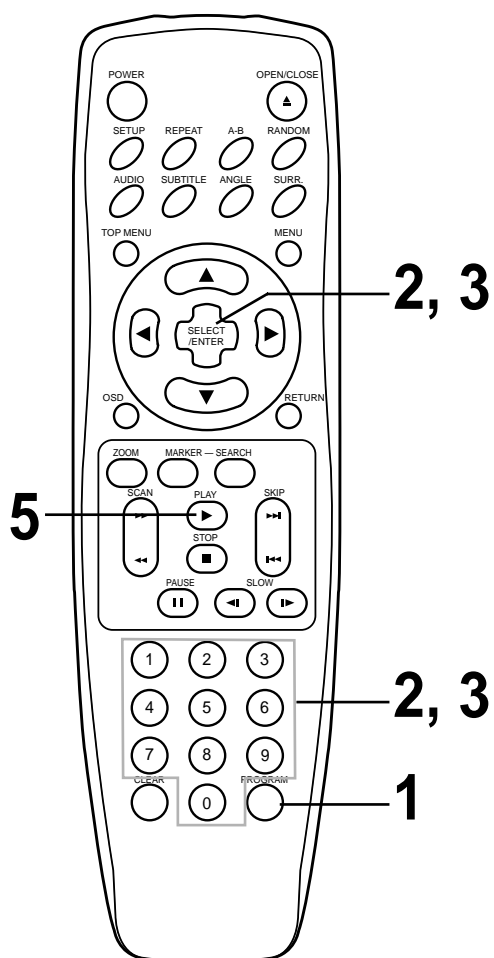

Playback with MP3

MP3

To play an MP3 file

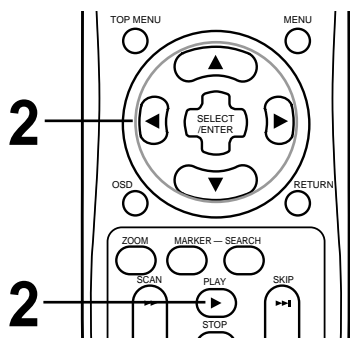

- 1 Load an MP3 disc.**
The MP3 menu is displayed.

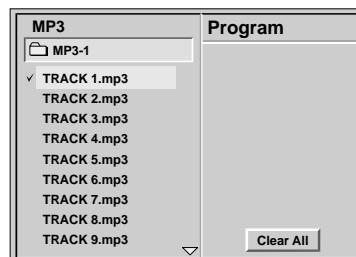

- 2 Press ▲/▼ button to select the desired MP3 file and then press PLAY to start playback of the file.**

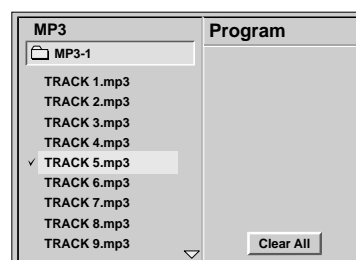

To play an MP3 file repeatedly

- If you press REPEAT once during play, the current MP3 file will play repeatedly.
- If you press REPEAT twice during play, the all MP3 files on the disc will play repeatedly.
- If you press REPEAT three times, the repeat play will be cancelled.

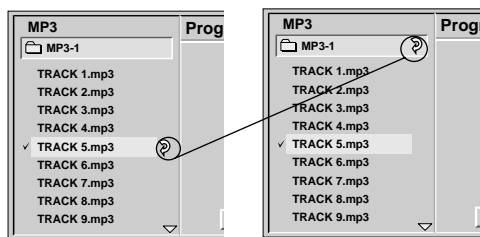

REPEAT symbol

Notes

- The file name is only displayed in English.
- If there is an impossible code to display, it will be displayed underlined (_) instead of English.
- This unit can play up to 200 files per disc. A disc recorded with more than 200 files cannot be played.
- Disc format is compatible with ISO9660 only.
- If you record MP3 files using the software which cannot create a FILE SYSTEM, for example "Direct-CD" etc., it is impossible to playback MP3 files. We therefore recommend that you use "Easy-CD Creator", which creates an ISO9660 file system.
- A single session disc requires MP3 files in the first track. If there is no MP3 file in the 1st track, it cannot playback MP3 files. If you wish to playback MP3 files, format all the data in the disc or use a new one.
- If there are already data files which are not MP3 files on the CD-R disc, please, do not use that disc; use a new one instead. However, if the disc is a CD-RW disc, this does not apply.

For your reference

- Press SKIP ►► or SKIP ◄◄ to play the next file or previous file during playback.
- Press OSD to move to the next page.
- Press PAUSE to enter the pause mode, press PLAY or PAUSE again to return to normal playback.
- Press STOP to stop the playback.

Playback with MP3 (Cont'd) **MP3**

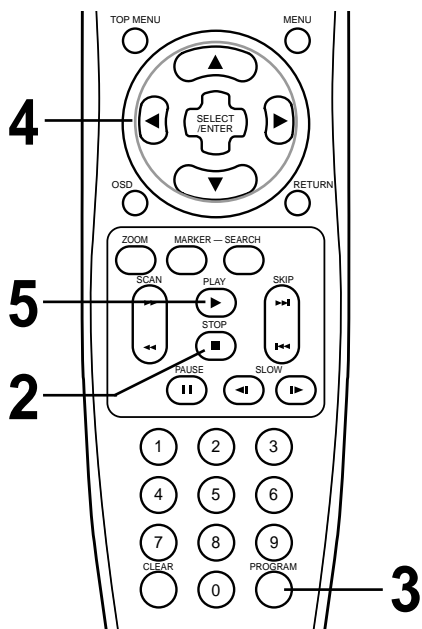

To program play an MP3 file

- 1** Load an MP3 disc.
The MP3 menu is displayed.
- 2** Press STOP to stop playback.
- 3** Press PROGRAM to enter the Program Edition mode in the stop mode.
The mark appears on the right of the word Program on the right side of MP3 menu. Press RETURN to exit the Program Edition mode, the mark will disappear.
- 4** Press / to select the desired MP3 file and then press SELECT/ENTER to add the MP3 file to the program list.
 - Repeat steps 4 to select another track.
 - Up to 60 files can be programmed.

To play an MP3 file repeatedly

- If you press REPEAT button once during play, the current MP3 file will play repeatedly.
- If you press REPEAT button twice during play, the all MP3 files on the program list will play repeatedly.
- If you press REPEAT button three times, the repeat play will be cancelled.

Program

✓ TRACK 2.mp3

TRACK 7.mp3

TRACK 6.mp3

TRACK 9.mp3

Clear All

Program

TRACK 2.mp3

TRACK 7.mp3

TRACK 6.mp3

TRACK 9.mp3

Clear All

REPEAT symbol

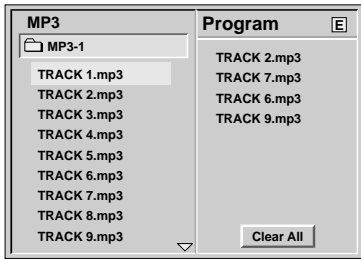

- 5** Press PLAY to play.
The playback now begins in the programmed sequence.

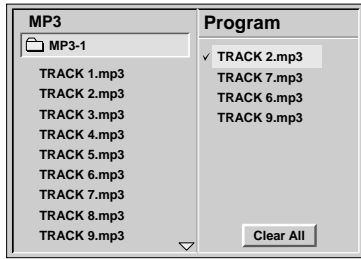

Clearing the program

- **To clear the program one by one**
In the Program Edition mode, press /// to select the unwanted MP3 file on the program list and then press CLEAR.
- **To clear all the programs**
In the Program Edition mode, press /// to select the "Clear All" and press SELECT/ENTER.

If you want to enter the main menu, press button.

After playback all tracks programmed
Play is stopped.

Selection of Initial Settings



Once the initial settings have been completed, the player can always be operated under the same conditions (especially with DVD discs). The settings will be retained in the memory until they are changed, even if the power is switched off.

Selection of initial settings

- 1 Press SETUP in the stop or playback mode.**
The SETUP menu is displayed.

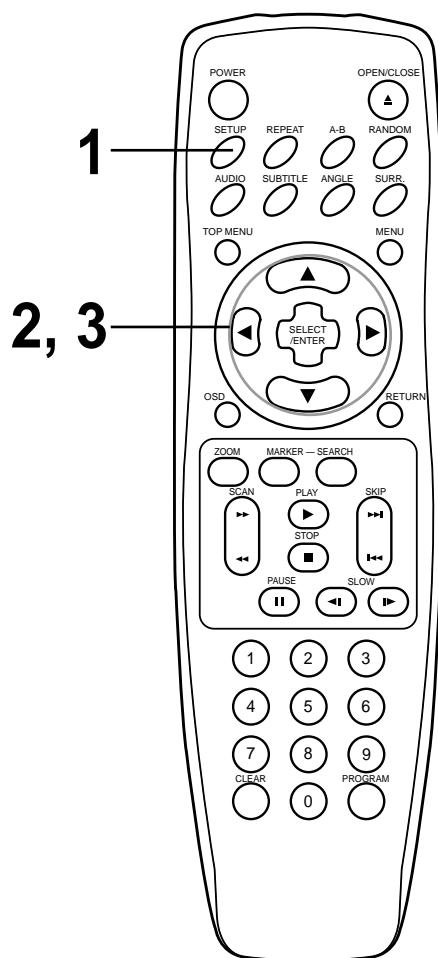
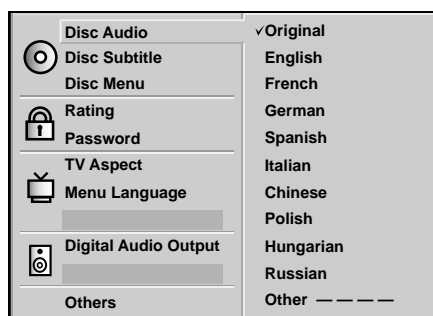

- 2 Press ▲/▼ to select the desired item.**
The screen will show the current setting for the selected item, and the alternate setting(s).

- Disc Audio (see page 34.)
- Disc Subtitle (see page 34.)
- Disc Menu (see page 34.)
- Rating (see page 35.)
- Password (see page 36.)
- TV Aspect (see page 37.)
- Menu Language (see page 38.)
- Digital Audio Output (see page 39.)
- Others (see page 40.)

- 3 Press ► and then ▲/▼ to select the desired setting and press SELECT/ENTER.**
 - Some items require additional steps. (See the respective page.)

When the alternate setting is selected the screen returns to the Initial Settings display.

To exit SETUP menu

Press SETUP, RETURN or PLAY.

Selecting Disc Languages



This is to select the audio soundtrack language, subtitle language and the language used in title menus or DVD menus which will always be used for every disc to be played back.

When you play back a DVD video disc, the DVD player automatically displays the pre-selected subtitle language if it is included on the disc.

1 At the setup screen, press ▲/▼ to select “Disc Audio” and press ►.



2 Press ▲/▼ to select the desired language and then press SELECT/ENTER.

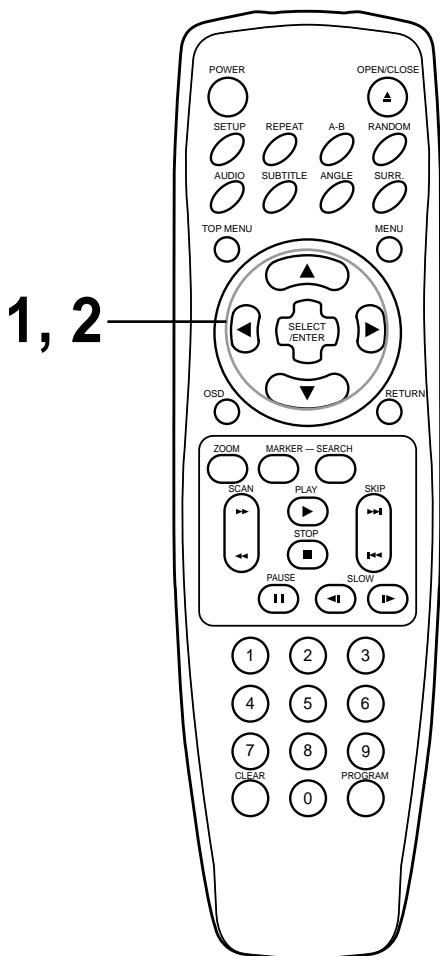

- Original** :The original language of each disc will be selected.
- English** : The English will be Selected.
- Other** : Another language can be selected. You can input 4-digit language code. (Refer to the language codes on page 41. Press CLEAR if an incorrect language code is entered.)

The “Disc Subtitle” and “Disc Menu” are selected by the same method.

Note

- If the language selected is not available on the disc, the original language designated by each disc will be selected.



Selecting Rating Level and Password

This is to prohibit the playing of specified DVDs which are unsuitable for children.

- Some DVD discs contain a restriction level which enables parents to remove scenes or prevent playback of discs by children. DVD players are equipped with a password designed to prevent children from changing the level.

Selecting rating level (DVD only)

- At the SETUP screen, press ▲/▼ to select "Rating" and press ►.

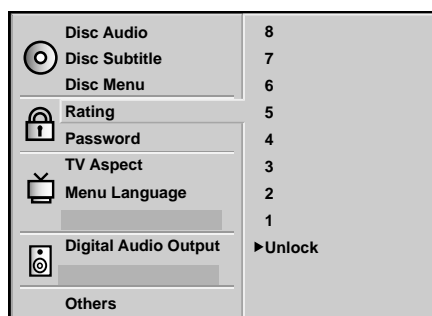

- Press ▲/▼ to select the desired level and press SELECT/ENTER.

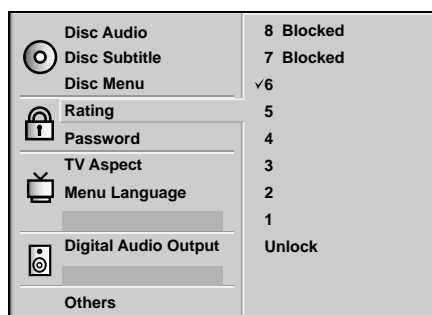

1, 2

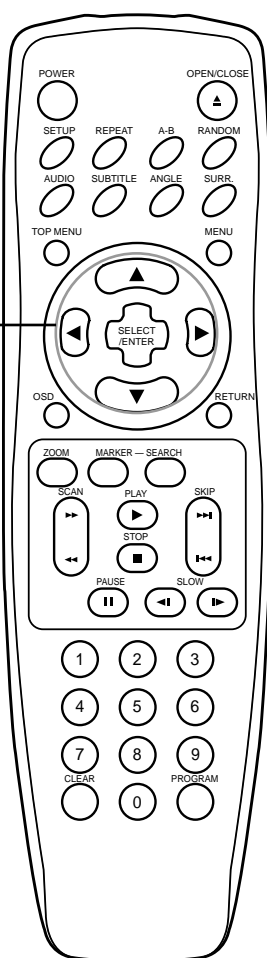

You cannot play DVD video discs rated higher than the level you selected unless you cancel the parental lock function. For example, when you select level 7, discs rated higher than level 7 are blocked and cannot be played.

The parent lock level is equivalent to the following USA movie ratings.

Level 7: NC-17	Level 6: R	Level 4: PG 13
Level 3: PG	Level 1: G	

- Some titles do not match with the rating level described as above.

If you change the level and enter a password, playback of all DVDs with ratings higher than your selection will be blocked, unless the correct password is entered again. For example: if you change the level to "5", the DVD player will not play discs with ratings of "6", "7" or "8" unless the correct password is entered on the remote control.

Selecting Rating Level and Password (Cont'd)

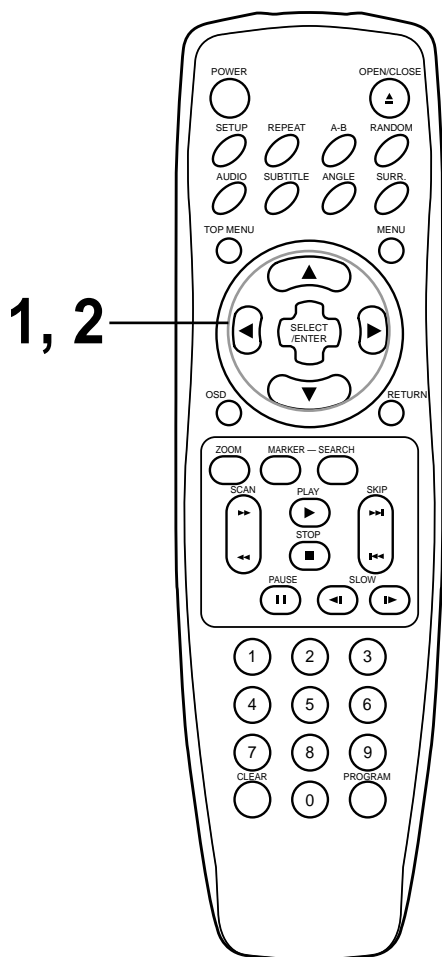

Setting your password (DVD only)

If you change the rating level to “7” or lower, you must enter a 4-digit “password” to prevent playback of discs with higher ratings.

- 1 At the SETUP screen, press ▼ to select “Password” and press ►.

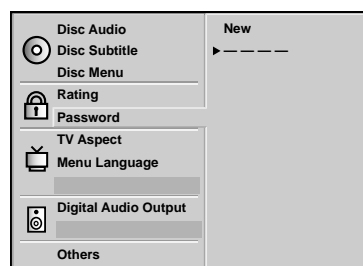

- 2 Input a 4-digit password and press SELECT/ENTER.

Example : 1234
Do not forget your password.

- 3 Input the 4-digit password again and press SELECT/ENTER to verify.

Setting is finished.

- The rating is locked. Any disc whose rating is higher than the setting, cannot be played back unless the correct password is entered.

To change/clear memorized password

- 1 At the SETUP screen, press ▼ to select “Password” and press ►.

- 2 Input your password and press SELECT/ENTER.

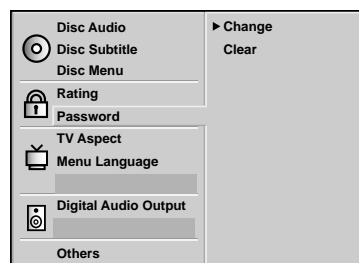

- 3 To change or clear your password, press ▲/▼ to select the “Change” or “Clear” and press SELECT/ENTER.

To change the rating level/password, follow the steps on page 35-36 again.

To clear your 4-digit password

If you forget your password, to clear the current password, follow the procedure below.

- 1 Press SETUP.
The SETUP menu is displayed.
- 2 Enter 6-digit number “210499” by pressing number buttons.
The 4-digit password is cleared. “P CLR” appears on the display.
- 3 Enter a new password.
Refer to “Setting your password” section on the right.

Selecting TV Aspect



Select the appropriate screen type according to your TV set; conventional size screen (4:3) or wide-screen (16:9).

1 At the **SETUP** screen, press **▲/▼** to select “**TV Aspect**” and press **▶**.

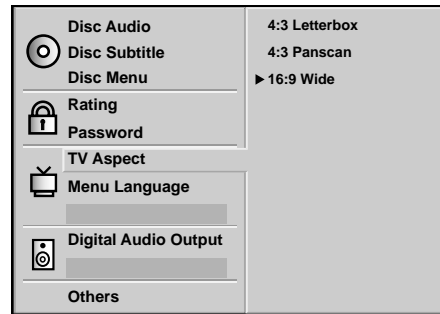
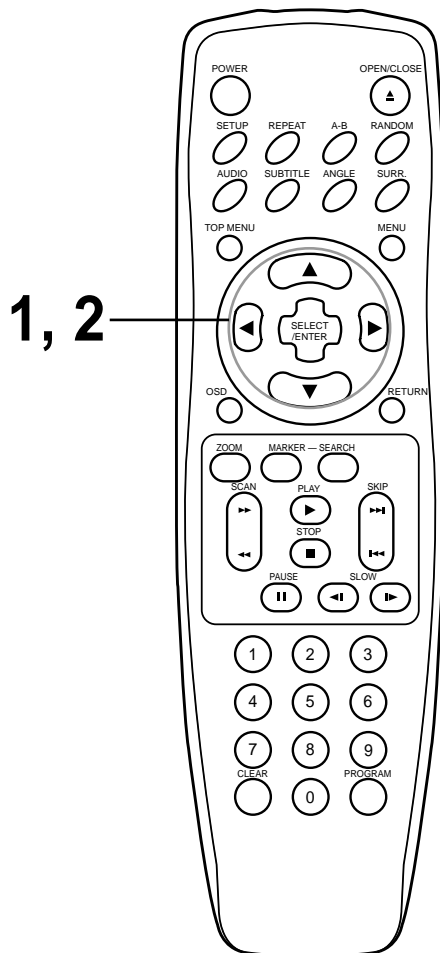

2 Press **▲/▼** to select the desired Aspect and press **SELECT/ENTER**.

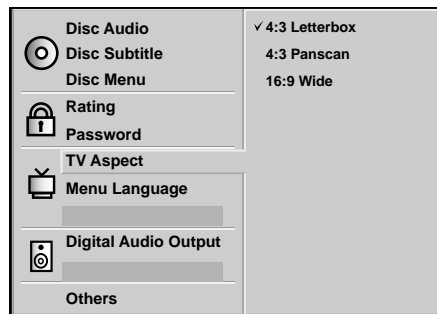

4:3 Letterbox : The video material not formatted in the Pan & Scan style is played back in the letterbox style (black bands appear at top and bottom of screen).

4:3 Panscan : Select when a conventional TV set is connected. The video material formatted in the Pan & Scan style is played back in that style (the left and right edges are cut off).

16:9 Wide : Select when a wide-screen TV set is connected. Played in “FULL” size. (Setting the wide-screen TV to “FULL” mode is also necessary.)

* Each screen shows an example when the video material for a wide-screen is played. (This setting does not affect the video material for conventional size.)



4:3 Letterbox

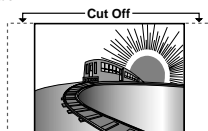

4:3 Panscan



16:9 Wide

Selecting Menu Language



Selects language for SETUP menus and displays on the TV.

1 At the **SETUP** screen, press **▲/▼** to select “Menu Language” and press **▶**.

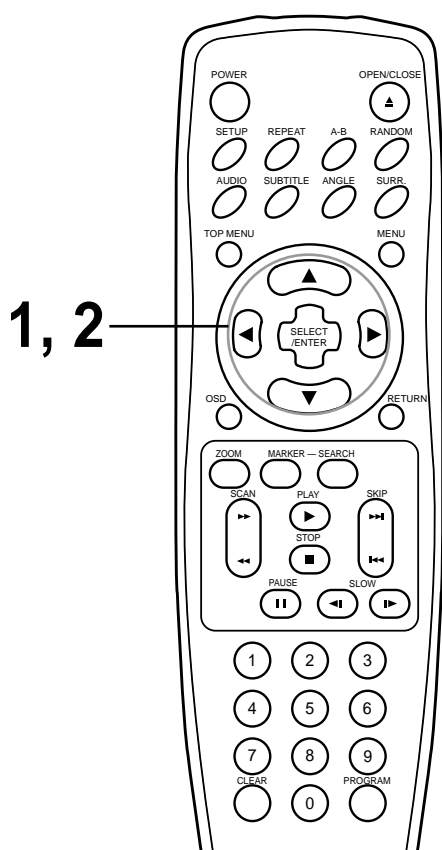

2 Press **▲/▼** to select the desired Language and press **SELECT/ENTER**.

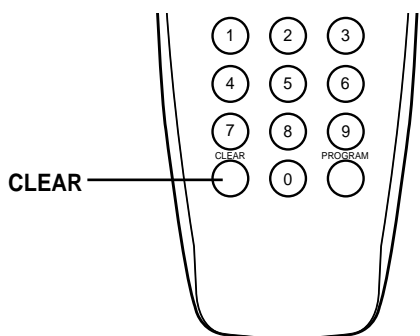

- This DVD player support two remote control codes : C1 and C2.
- When the unit is shipped from the factory, the remote code is set to C1.
- To change the remote control cods, press and hold CLEAR button for at least five seconds.
- Changed Remote control codes is displayed in the Display window.
- Set the remote control codes of the Remote control to the same setting (page 10).

Note

- This setting can not be used if a disc is playing.
- If a DVD has been loaded, be sure to press STOP twice before proceeding.



Selecting Digital Audio Output

Each DVD disc has a variety of audio output options. Set the player's Digital Audio Output according to the type of audio system you use.

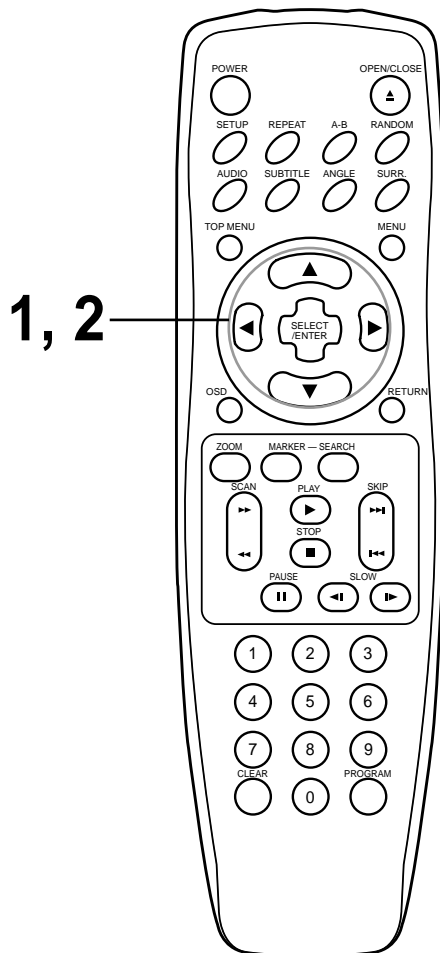

- At the **SETUP** screen, press **▲/▼** to select **Digital Audio Output** and press **▶**.

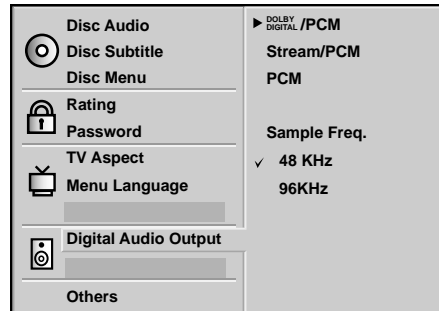

- Press **▲/▼** to select the desired output and press **SELECT/ENTER**.

You can select Digital Audio Output or Sampling Frequency item by pressing **SELECT/ENTER**.

■ Digital Audio Output

DOLBY DIGITAL/PCM: Select "DOLBY DIGITAL/PCM" if an active digital output is supplied to a Dolby Digital decoder, (or an amplifier or other equipment with Dolby Digital decoder).

Stream/PCM: Select "Stream/PCM" if an active digital output is supplied to an amplifier or other equipment with DTS decoder, Dolby Digital decoder and MPEG decoder.

PCM: Select "PCM" if an active digital output is supplied to an amplifier or other equipment with linear PCM only (or MD recorder or DAT deck).

■ Sampling Frequency

To change the Sample Frequency setting, first select the desired digital audio output type as indicated above. If your A/V receiver or surround processor is NOT capable of handling 96kHz signals, select the 48kHz option. When this choice is made, this unit will automatically convert any 96kHz signals to a 48kHz output so that your system is capable of decoding them.

If your A/V receiver or surround processor is capable of handling 96kHz signals, select the 96kHz option. When this choice is made, this unit will pass each type of signal through without any further processing.

Notes

- If an active digital audio output signal is supplied to a receiver or other equipment without a corresponding digital decoding capability, a very loud noise may be produced which could permanently damage the speakers.
- The DTS DVD disc sound is played back only when the DVD player is connected to a receiver with a DTS decoder.

Playback Disc	OUTPUT		
	Stream/PCM	Dolby Digital/PCM	PCM only
96 kHz Linear PCM DVD	PCM	PCM	PCM
DTS DVD	DTS bit Stream	DTS bit Stream	DTS bit Stream
Dolby Digital DVD	Dolby Digital bit Stream	Dolby Digital bit Stream	PCM
MPEG DVD	MPEG bit Stream	PCM	PCM
Audio CD	PCM	PCM	PCM
DTS Audio CD	DTS bit Stream	DTS bit Stream	DTS bit Stream

Others



The DRC, Vocal and Video settings can be changed.

1 At the **SETUP** screen, press **▲/▼** to select “Others” and press **▶**.

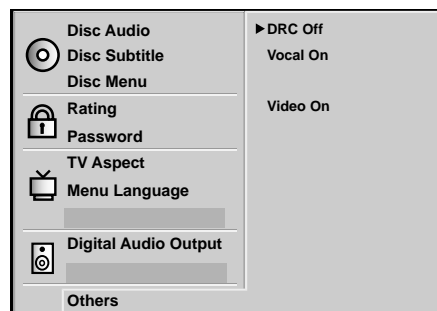
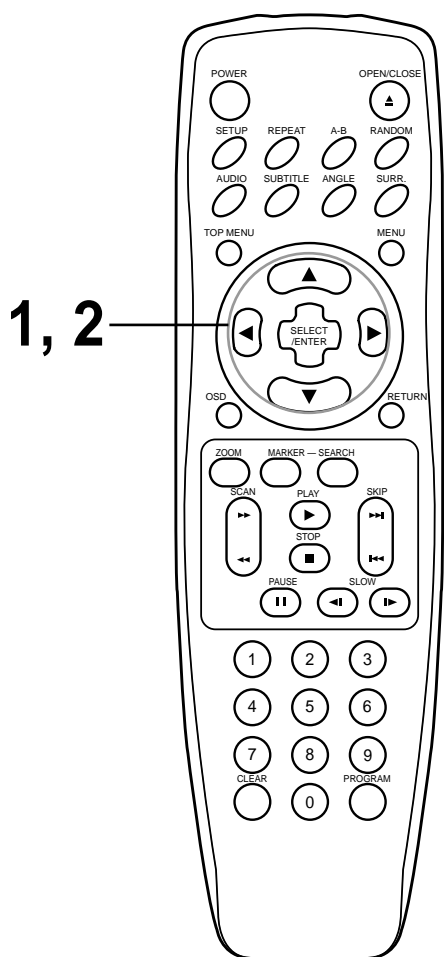

2 Press **▲/▼** to select the desired items and press **SELECT/ENTER**.
The setting of the selected item are changed between On and Off.

■ **DRC (Dynamic Range Compression) On/Off**

- On:** Select this option to turn on the Dynamic Range Compression circuitry so that the dialogue remains clear even at low volume levels.
- Off:** Select this option to turn off the Dynamic Range Compression and have the soundtrack presented exactly as it was created.

■ **Vocal On/Off**

Set to On only when a multi-channel karaoke DVD is being played. The karaoke channels on the disc will then be mixed into a normal stereo sound.

■ **Video On/Off**

Setting this option to Off is one of the best ways to achieve optimum sound quality from Audio CD playback and video output will be cut.

About DRC (Dynamic Range Compression)

With the DVD format you have the opportunity to hear a program’s soundtrack in the most accurate and realistic presentation possible, thanks to the use of digital audio technology. However, in certain instances you may wish to slightly compress the dynamic range of the audio output (the difference between the loudest sounds and the quietest ones) so that you may listen to a movie at a lower volume without losing dialogue intelligibility.

Notes

- The DRC function works only during playback of Dolby Digital recorded discs.
- The level of Dynamic Range Compression may differ depending on the DVD disc.
- When playing karaoke, connect appropriate audio equipment (such as an amplifier) to the DVD video player.

Table of Language and Their Abbreviations





Enter the appropriate code number for the initial settings "Audio", "Subtitle" and/or "Menu" (See page 34).

Code	Language	Code	Language	Code	Language	Code	Language
6565	Afar	7079	Faroese	7678	Lingala	8375	Slovak
6566	Abkhazian	7082	French	7679	Laothian	8376	Slovenian
6570	Afrikaans	7089	Frisian	7684	Lithuanian	8377	Samoa
6577	Ameharic	7165	Irish	7686	Latvian, Lettish	8378	Shona
6582	Arabic	7168	Scots Gaelic	7771	Malagasy	8379	Somali
6583	Assamese	7176	Galician	7773	Maori	8381	Albanian
6588	Aymara	7178	Guarani	7775	Macedonian	8382	Serbian
6590	Azerbaijani	7185	Gujarati	7776	Malayalam	8385	Sundanese
6665	Bashkir	7265	Hausa	7778	Mongolian	8386	Swedish
6669	Byelorussian	7273	Hindi	7779	Moldavian	8387	Swahili
6671	Bulgarian	7282	Croatian	7782	Marathi	8465	Tamil
6672	Bihari	7285	Hungarian	7783	Malay	8469	Telugu
6678	Bengali; Bangla	7289	Armenian	7784	Maltese	8471	Tajik
6679	Tibetan	7365	Interlingua	7789	Burmese	8472	Thai
6682	Breton	7378	Indonesian	7865	Nauru	8473	Tigrinya
6765	Catalan	7383	Icelandic	7869	Nepali	8475	Turkmen
6779	Corsican	7384	Italian	7876	Dutch	8476	Tagalog
6783	Czech	7387	Hebrew	7879	Norwegian	8479	Tonga
6789	Welsh	7465	Japanese	7982	Oriya	8482	Turkish
6865	Danish	7473	Yiddish	8065	Panjabi	8484	Tatar
6869	German	7487	Javanese	8076	Polish	8487	Twi
6890	Bhutani	7565	Georgian	8083	Pashto, Pushto	8575	Ukrainian
6976	Greek	7575	Kazakh	8084	Portuguese	8582	Urdu
6978	English	7576	Greenlandic	8185	Quechua	8590	Uzbek
6979	Esperanto	7577	Cambodian	8277	Rhaeto-Romance	8673	Vietnamese
6983	Spanish	7578	Kannada	8279	Rumanian	8679	Volapük
6984	Estonian	7579	Korean	8285	Russian	8779	Wolof
6985	Basque	7583	Kashmiri	8365	Sanskrit	8872	Xhosa
7065	Persian	7585	Kurdish	8368	Sindhi	8979	Yoruba
7073	Finnish	7589	Kirghiz	8372	Serbo-Croatian	9072	Chinese
7074	Fiji	7665	Latin	8373	Singhalese	9085	Zulu

Disc Requirements/Copyright Information

Playable Discs

This DVD player can play back the following discs.

	Disc mark	Contents	Disc size	Maximum playback time
DVD video discs		Audio+Video (moving pictures)	12 cm	Approx. 4 hours (single sided disc)
				Approx. 8 hours (double sided disc)
			8 cm	Approx. 80 minutes (single sided disc)
				Approx. 160 minutes (double sided disc)
Audio CDs		Audio	12 cm	74 minutes
			8 cm	20 minutes

In addition, this unit can play back a CD-R or CD-RW that contains audio titles or MP3 files.
 You cannot playback discs other than those listed above. (Video CD, HDCD, CD-ROM, CD-Extra, CD-G, photo CD, and CD-i discs can not be played on this DVD player.)

Region Management Information

Region Management Information: This DVD Player is designed and manufactured to respond to the Region Management Information that is recorded on a DVD disc. If the Region number described on the DVD disc does not correspond to the Region number of this DVD player, this DVD player cannot play that disc.

The Region number of this DVD player is 1.



Notes on Unauthorized Discs

You may not be able to play back some DVD video discs on this player if they were purchased from outside your geographic area or made for business purposes.
 When you try to play back an unauthorized disc, "Check Regional Code" appears on the TV screen.

Notes on Copyright

It is forbidden by law to copy, broadcast, show, broadcast on cable, play in public, and rent copyrighted material without permission.
 DVD video discs are copy protected, and any recordings made from these discs will be distorted.
 This product incorporates copyright protection technology that is protected by method claims of certain U.S. patents and other intellectual property rights owned by Macrovision Corporation and other rights owners. Use of this copyright protection technology must be authorized by Macrovision Corporation, and is intended for home and other limited viewing uses only, unless otherwise authorized by Macrovision Corporation. Reverse engineering or disassembly is prohibited.

Before Calling Service Personnel

Symptoms and Correction

Check the following guide for the possible cause of a problem before contacting service.

Symptom	Cause	Correction
No power.	<ul style="list-style-type: none"> The power cord is disconnected. 	<ul style="list-style-type: none"> Plug the power cord into the wall outlet securely.
The power is on, but the DVD player does not work.	<ul style="list-style-type: none"> No disc is inserted. 	<ul style="list-style-type: none"> Insert a disc. (Check that the DVD or, audio CD indicator in the DVD display is lit.)
No picture.	<ul style="list-style-type: none"> The TV is not set to receive DVD signal output. 	<ul style="list-style-type: none"> Select the appropriate video input mode on the TV so the picture from the DVD player appears on the TV screen.
	<ul style="list-style-type: none"> The video cable is not connected securely. 	<ul style="list-style-type: none"> Connect the video cable into the jacks securely.
	<ul style="list-style-type: none"> The connected TV power is turned off. 	<ul style="list-style-type: none"> Turn on the TV.
No sound.	<ul style="list-style-type: none"> The equipment connected with the audio cable is not set to receive DVD signal output. 	<ul style="list-style-type: none"> Select the correct input mode of the audio receiver so you can listen to the sound from the DVD player.
	<ul style="list-style-type: none"> The audio cables are not connected securely. 	<ul style="list-style-type: none"> Connect the audio cable into the jacks securely.
	<ul style="list-style-type: none"> The power of the equipment connected with the audio cable is turned off. 	<ul style="list-style-type: none"> Turn on the equipment connected with the audio cable.
	<ul style="list-style-type: none"> The Digital Audio Output is set to the wrong position. 	<ul style="list-style-type: none"> Set the Digital Audio Output to the correct position, then turn on the DVD player again by pressing the POWER button.
The playback picture is poor.	<ul style="list-style-type: none"> The disc is dirty. 	<ul style="list-style-type: none"> Clean the disc.
The DVD player does not start playback.	<ul style="list-style-type: none"> No disc is inserted. 	<ul style="list-style-type: none"> Insert a disc. (Check that the DVD, or audio CD indicator in the DVD display is lit.)
	<ul style="list-style-type: none"> An unplayable disc is inserted. 	<ul style="list-style-type: none"> Insert a playable disc. (Check the disc type, color system and Regional code.)
	<ul style="list-style-type: none"> The disc is placed upside down. 	<ul style="list-style-type: none"> Place the disc with the playback side down.
	<ul style="list-style-type: none"> The disc is not placed within the guide. 	<ul style="list-style-type: none"> Place the disc on the disc tray correctly inside the guide.
	<ul style="list-style-type: none"> The disc is dirty. 	<ul style="list-style-type: none"> Clean the disc.
	<ul style="list-style-type: none"> A menu is on the TV screen. 	<ul style="list-style-type: none"> Press the SETUP button to turn off the menu screen.
	<ul style="list-style-type: none"> The Rating level is set. 	<ul style="list-style-type: none"> Cancel the Rating function or change the rating level.
The remote control does not work properly.	<ul style="list-style-type: none"> The remote control is not pointed at the remote sensor of the DVD player. 	<ul style="list-style-type: none"> Point the remote control at the remote sensor of the DVD player.
	<ul style="list-style-type: none"> The remote control is too far from the DVD player. 	<ul style="list-style-type: none"> Operate the remote control within about 17 ft (5 m).
	<ul style="list-style-type: none"> There is an obstacle in the path of the remote control and the DVD player. 	<ul style="list-style-type: none"> Remove the obstacle.
	<ul style="list-style-type: none"> The batteries in the remote control are exhausted. 	<ul style="list-style-type: none"> Replace the batteries with new ones.
	<ul style="list-style-type: none"> Remote control code is different between the DVD player and Remote control. 	<ul style="list-style-type: none"> Set the remote control codes of both DVD player and Remote control to the same setting.

Specifications

DVD player/Outputs/Supplied Accessories

[DVD player]	Power supply	AC 120V, 60 Hz
	Power consumption	16 W
	Weight	7.1 lbs (3.2 kg)
	External dimensions (W X H X D)	17.3" X 3.5" X 10.0" (440 x 88 x 254 mm)
	Signal system	NTSC
	Laser	Semiconductor laser, wavelength 650 nm (DVD), 780 nm (CD)
	Frequency range (audio)	DVD: fs = 96 kHz 4 Hz - 44 kHz fs = 48 kHz 4 Hz - 22 kHz CD: 4 Hz - 20 kHz
	Signal-to-noise ratio (audio)	More than 105 dB (EIAJ)
	Dynamic range (audio)	More than 100 dB (EIAJ)
	Harmonic distortion (audio)	0.003 %
	Wow and flutter	Below measurable level (less than + 0.001 % (W.PEAK)) (EIAJ)
	Operating conditions	Temperature: 41°F to 95°F, Operation status: Horizontal
[Outputs]	Video output	1.0 V (p-p), 75 Ω, negative sync., RCA jack x 1
	S-video output	(Y) 1.0 V (p-p), 75 Ω, negative sync., Mini DIN 4-pin x 1 (C) 0.286 V (p-p), 75 Ω
	Component video output	(Y) 1.0 V (p-p), 75 Ω, negative sync., RCA jack x 1 (CB)/(CR) 0.7 V (p-p), 75 Ω
	Audio output (digital audio)	0.5 V (p-p), 75 Ω, RCA jack x 1
	Audio output (analog audio)	2.0 Vrms(1 KHz, 0 dB), 330 Ω, RCA jack (L, R) x 2
[Supplied Accessories]	● Video cable	1
	● Audio cable	1
	● System Control cable.....	1
	● Remote control.....	1
	● Batteries	2

* Designs and specifications are subject to change without notice.

COUNTRY	COMPANY	ADDRESS
ALGERIE	Azur 2000	8, Lotissement Ben Hatadi, Alger, Algerie
ARMENIA	NGYIG Ltd.	47 A/75 St. Lalaianst, 375000 Yerevan, Armenia
AUSTRALIA	Jamo Australia Pty. Ltd.,	24 Lionel Road, Mt. Waverley, VIC 3149, Australia
AUSTRIA	Huber & Prohaska GmbH	Taborstraße 95 / Ladestraße 1, Gebäude Hangartner, A-1200 Wien, Austria
BAHREIN	Ambassador Stores	P.O. Box 237,141, Government Avenue, Manama, Bahrein
BANGLADESH	Target	1078, Ramjoy Mohanja Lane Asadgonj, Chittagong 4000, Bangladesh
BELGIUM	Van der Heyden Audio N.V.	Brusselbaan 278, 9320 Erembodegem, Belgium
BULGARIA	Ariescommerce GmbH	Makedonia Blvd. 16, 1606 Sofia, Bulgaria
CANADA	Lenbrook Industries Limited	633 Granite Court, Pickering, Ontario
CHINA	Guang Chang Audio International Co., Ltd.	No.38 Yushan Road, ShiQiao, Pan Yu, Guang Dong, China
CYPRUS	Empire Hifi systems Ltd.	P.O. Box 5604, Nicosia, Cyprus
CZECH REPUBLIC	Audio International	Sokolska 41, 67902 Rajecok, OKR, Blansko, Czech Republic
DENMARK	Audio Nord	Dali Allé 1, 9610 Noerager, Denmark
DUBAI	V.V.& SONS	P.O. Box 105, Dubai, U.A.E.
EGYPT	Solimco	9, El Attibaa St. Doki, Cairo, Egypt
ESTONIA	HiFi Club Estonia	Ehte 4, 90503 Haapsalu, Estonia
F.Y.R.O.M.	T.P. KODI	ul.Cedomir Kantargiev 21a, Skopje, Former Yugoslavian Republic of Macedonia
FINLAND	Audio Nord	Uudenmaankatu 4-6, Helsinki SF-00120, Finland
FRANCE	Marantz France	A division of Marantz Europe B.V., P.O. Box 301, 92 156 Suresnes Cedex, France
GERMANY	Marantz Deutschland	Hakenbusch 3, 49078 Osnabrück, Germany
GREECE	Adamco S.A.	188, Hippocratous Street, 11471 Athens, Greece
HEADQUARTERS EUROPE:	Marantz Europe B.V.	Building SFF-2, P.O. Box 80002, 5600 JB Eindhoven, The Netherlands
HONG KONG	Marantz Asia Ltd.	Unit 1706, Metroplaza II, 223 Hing Fong Road, Kwai Fong, N.T., Kowloon, Hong Kong
HUNGARY	Infovox Ltd.	Terez Krt.31, 1067 Budapest, Hungary
ICELAND	ID Electronics Ltd.	Armula 38, 108 Reykjavik, Iceland
INDIA	NOVA Audio Private	8,Punam Co-op.Society 29/30 Road#5, Union Park MUMBAI 400052, India
IRAN	Home Co.	5th floor no 878 Philips Building Enghelab ave, P.O. 11365/7844 Tehran, Iran
IRELAND	Marantz Ireland	Clonskeagh, Dublin 14, Ireland
ISRAEL	Elmor Ltd.	52 Heh Beiyar Street, Kikar Hamedina, Tel Aviv, Israel
ITALY	Marantz Italy	Via Casati 23, 20052 Monza (Milano), Italy, Servizio Consumatori 1678-20026, Numero Verde
IVORY COAST	Hifivoir	B.P. 2428, Abidjan 01, Ivory Coast
JAPAN	Marantz Japan Inc.	35-1 Sagami Ohno 7-Chome, Sagamihara-shi, Kanagawa 228-8505, Japan
KOREA	Mk Enterprises Ltd.	121-210, 2F Shinhan Bldg., 247-17 Seokyo-dong, Mapo-ku, Seoul, Korea
KUWAIT	alAlamiah Electronics Intl.	P.O. Box 8196, Salmiah 22052, Kuwait
LATVIA	Ace Ltd.	61, LacPlesa Str., Riga LV 1011, Latvia
LEBANON	AZ Electronics S.A., 1,	P.O. Box 11 2833, Beirut, Lebanon
LITHUANIA	Accapella Ltd.	Ausros, Vartu G/5, Pasazo SKG., 2001 Vilnius, Lithuania
MALAYSIA	Wo Kee Hong Electronics Sdn. Bhd.	Suite 8.1, Level 8, Menara Genesis, No. 33, Jalan Sultan Ismail, 50250 Kuala Lumpur, Malaysia
MALTA	Doneo Co Ltd.	78 The Strand, Sliema SLM07, Malta
MAURITIUS	SKR Electronics Ltd.	P.O. Box 685, Bell Village, Port Louis, Mauritius
MILITARY MARKET EUROPE	PASCO GmbH	PO BOX 1280, Sandhausen 69200, Germany
NETHERLANDS	Marantz Domestic Sales	A division of Marantz Europe B.V., Building SFF2, P.O. Box 80002, 5600 JB Eindhoven, The Netherlands
NEW ZEALAND	Wildash Audio Systems	14 Malvern Road, Mt. Albert, Auckland, New Zealand
NORWAY	Audio Nord	Sandkerveien 64, Oslo 0483, Norway
OMAN	Mustafa & Jawad Trading CO.	P.O. Box 1918, Ruwi, Oman
POLAND	Philips Polska Sp. z.o.o.	Al.Jerozolimskie 195b, 02 222 Warszawa, Poland
PORTUGAL	Corel2	Comércio de Electrónica Lda., Av. Luis Bivar, No 85 A, 1050 Lisboa, Portugal
PROFESSIONAL EUROPE	Marantz Professional Products	Kingsbridge House, Padbury Oaks, 575-583 Bath Road, Longford, Middlesex UB7 0EH, U.K.
PROFESSIONAL U.S.A.	Marantz Professional Products	Distributed by: Superscope Technologies Inc., 1000 Corporate Blvd. Ste.D, Aurora, Illino
QATAR	Almana & Partners W.W.L.	P.O. Box 49, Doha, Qatar
REUNION	Vision +	180 Rue du Marechal Leclerc, 97400 Saint Denis, Ile de la Reunion
ROMANIA	Nova Music Entertainment	5, Zagazului Str. Bl.1G,apt.18, sector 1,Bucharest, Romania
RUSSIA	Absolute Audio	7/2, Montazhnaya Street, 107497 Moscow, Russia
SAUDI ARABIA	Adawlia Univ. Electr. Apl	P.O. Box 2154, Alkhobar 31952, Saudi Arabia
SINGAPORE	Wo Kee Hong Distribution PTE Ltd.	130 Joo Seng Road, #03-02 Olivine Building, Singapore 368357
SLOVAKIA	Bis Audio s.r.o.	Nam. SNP 10, 96001 Zvolom, Slovakia
SLOVENIA	Bofex	Smartinska 152, HALA V/3, 61000 Ljubljana, Slovenia
SOUTH AFRICA	Coherent Imports (PTY) Ltd.	P.O. Box 1614, Alberton, 1450, South Africa
SPAIN	Marantz Spain	Martinez Villergas 2, Apartado 2065, Madrid 28027, Spain
SRI LANKA	The listening Room	Mezzanine Floor, The Landmark 385, Galle Road, Colombo - 3, Sri Lanka
SWEDEN	Audio Nord	Almedalsvagen 4, Gotenborg 402-23, Sweden
SWITZERLAND	Sound Company AG	Postfach, 8010 Zürich, Switzerland
SYRIA	Hamzeh & Partners	Hafez Ibrahim Str. No 117, Damascus Shalan, Syria
TAHITI	Covecolor	Av. Prince Hinoi, Cours de l'union sacré, P.O. Box 2334, Papeete, Tahiti
TAIWAN	Pai-Yuing Co. Ltd.	6th No 148 Sung Kiang Road, Taipei 10429, Taiwan R.O.C.
THAILAND	MRZ Standard Co. Ltd.	746-750 Mahachai Road, Wangburapa, Bangkok 10200, Thailand
TUNESIA	Societe EDEVIG	40, Avenue du Golfe Arabe, El Menzah, 1004, Tunesia
TURKEY	Türk Philips Ticaret A.S.	Yukari Dudullu Organize sanayi Bolgesi, 2.Cadde no.28, 81260 Umraniye-Istanbul, Turkey
U.K.	Marantz Hifi UK Ltd.	Kingsbridge House, Padbury Oaks, 575-583 Bath Road, Longford, Middlesex UB7 0EH, U.K.
U.S.A.	Marantz America Inc.	1100 Maplewood Drive Itasca, IL 60143, U.S.A.
YUGOSLAVIA	ITM Company	Omladinskih Brigada 86, 11070 Belgrade, Yugoslavia
EXPORT	Marantz Domestic Sales	A division of Marantz Europe BV, Building SFF2, P.O. Box 80002, 5600 JB Eindhoven, The Netherlands

www.marantz.com

marantz® is a registered trademark.



P/NO: 3834RS0020N
Printed in China

304W851252