

DLP™ TECHNOLOGY REAR PROJECTION TELEVISION**DL5500****OPERATING GUIDE****IMPORTANT SAFEGUARDS****2-3****FIRST TIME USE****4-23****THE REMOTE CONTROL****24-36****ON SCREEN DISPLAY****37-67****USING THE DLP™ TECHNOLOGY
REAR PROJECTION TV AS A PC
MONITOR****68-78****LAMP REPLACEMENT
PLUG AND PLAY
TRADEMARK ACKNOWLEDGMENT
AGENCY REGULATORY INFORMATION
USEFUL INFORMATION
SPECIFICATIONS
SERVICE HOTLINE
FEATURE INFORMATION****79-91**

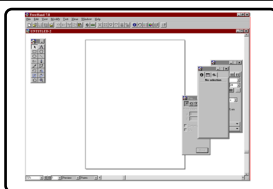

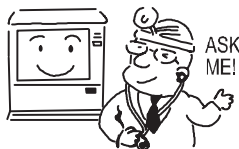



SAFETY POINTS YOU SHOULD KNOW ABOUT YOUR MARANTZ TELEVISION

Our reputation has been built on the quality, performance, and ease of service of MARANTZ televisions.

Safety is also foremost in our minds in the design of these units. To help you operate these products properly, this section illustrates safety tips which will be of benefit to you. Please read it carefully and apply the knowledge you obtain from it to the proper operation of your MARANTZ television.

Follow all warnings and instructions marked on this color television.

 <div style="border: 1px solid black; padding: 5px; text-align: center;"> <p>CAUTION</p> <p>RISK OF ELECTRIC SHOCK DO NOT OPEN</p> </div> 		<p>The lightning flash with arrowhead symbol, within an equilateral triangle, is intended to alert the user to the presence of uninsulated "dangerous voltage" within the product's enclosure that may be of a sufficient magnitude to constitute a risk of electric shock to persons.</p>
<p>CAUTION: TO REDUCE THE RISK OF ELECTRIC SHOCK, DO NOT REMOVE COVER (OR BACK). NO USER SERVICEABLE PARTS INSIDE. REFER SERVICING TO QUALIFIED SERVICE PERSONNEL.</p>		<p>The exclamation point within an equilateral triangle, is intended to alert the user to the presence of important operating and maintenance (servicing) instructions in the literature accompanying the appliance.</p>

WARNING:
TO PREVENT FIRE OR SHOCK HAZARD, DO NOT EXPOSE THIS TELEVISION TO RAIN OR MOISTURE.

NOTE:

- There are no user serviceable parts inside the color television.
- Model and serial numbers are indicated on back side of the television.
- This television is not intended for use in a computer room.

CAUTION: Adjust only those controls that are covered in the instructions, as improper changes or modifications not expressly approved by MARANTZ could void the user's authority to operate the television.



MODIFICATIONS: The FCC requires the user to be notified that any changes or modifications made to this device that are not expressly approved by Marantz America may void the user's authority to operate the equipment.

POWER SOURCE

THIS TELEVISION IS DESIGNED TO OPERATE ON 120 VOLTS 60Hz, AC CURRENT. INSERT THE POWER CORD INTO A 120 VOLT 60Hz OUTLET.

TO PREVENT ELECTRIC SHOCK, DO NOT USE THE COLOR TELEVISION'S (POLARIZED) PLUG WITH AN EXTENSION CORD, RECEPTACLE, OR OTHER OUTLET UNLESS THE BLADES AND GROUND TERMINAL CAN BE FULLY INSERTED TO PREVENT BLADE EXPOSURE.

NEVER CONNECT THE COLOR TELEVISION TO 50HZ, DIRECT CURRENT, OR ANYTHING OTHER THAN THE SPECIFIED VOLTAGE.

NOTE: This television receiver will display television closed captioning, ( or ) , in accordance with paragraph 15.119 of the FCC rules.

 **CAUTION:** Never remove the back cover of the television as this can expose you to very high voltages and other hazards. If the television does not operate properly, unplug the television and call your authorized dealer or service center.

IMPORTANT



Read before operating equipment

Follow all warnings and instructions marked on this television.

1. Read these instructions.
2. Keep these instructions.
3. Heed all warnings.
4. Follow all instructions.
5. Do not use this apparatus near water.
6. Clean only with a dry cloth.
7. Do not block any ventilation openings. Install in accordance with the manufacturer's instructions.
8. Do not install near any heat sources such as radiators, heat registers, stoves, or other apparatus (including amplifiers) that produce heat.
9. Do not defeat the safety purpose of the polarized or grounding-type plug. A polarized plug has two blades with one wider than the other. A grounding type plug has two blades and a third grounding prong. The wide blade or the third prong are provided for your safety. If the provided plug does not fit into your outlet, consult an electrician for replacement of the obsolete outlet.
10. Protect the power cord from being walked on or pinched particularly at plugs, convenience receptacles, and the point where they exit from the apparatus.
11. Only use the attachments/accessories specified by the manufacturer.

12.  Use only with the cart, stand, tripod, bracket, or table specified by the manufacturer, or sold with the apparatus. When a cart is used, use caution when moving the cart/apparatus combination to avoid injury from tip-over.

13. Unplug this apparatus during lightning storms or when unused for long periods of time.
14. Refer all servicing to qualified service personnel. Servicing is required when the apparatus has been damaged in any way, such as power-supply cord or plug is damaged, liquid has been spilled or objects have fallen into apparatus, the apparatus has been exposed to rain or moisture, does not operate normally, or has been dropped.

Do not place any objects on the top of the television which may fall or cause a child to climb to retrieve the objects.

15. Televisions are designed to comply with the recommended safety standards for tilt and stability. Do not apply excessive pulling force to the front, or top, of the cabinet which could cause the product to overturn resulting in product damage and/or personal injury.
16. Follow instructions for wall, shelf or ceiling mounting as recommended by the manufacturer.
17. An outdoor antenna should not be located in the vicinity of overhead power lines or other electrical circuits.
18. If an outside antenna is connected to the receiver, be sure the antenna system is grounded so as to provide some protection against voltage surges and built up static charges. Section 810 of the National Electric Code, ANSI/NFPA No. 70-1984, provides information with respect to proper grounding for the mast and supporting structure, grounding of the lead-in wire to an antenna discharge unit, size of grounding connectors, location of antenna-discharge unit, connection to grounding electrodes and requirements for the grounding electrode.

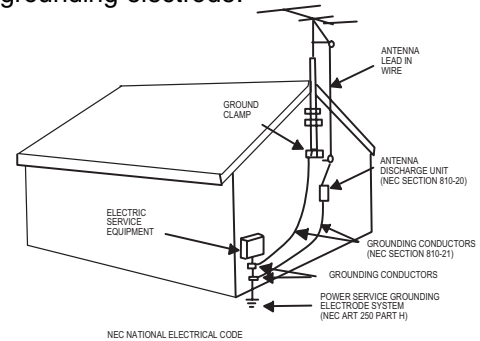

Note to the CATV system installer: This reminder is provided to call the CATV system installer's attention to Article 820-40 of the NEC that provides guidelines for proper grounding and, in particular, specifies that the cable ground shall be connected to the grounding system of the building, as close to the point of cable entry as practical.

Disposal of this product may require specific instructions pertaining to your resident state. For disposal or recycling information, please contact your local authorities or the Electronic Industries Alliance: www.eiae.org.

PREVENTION OF PATTERN BURN

Continuous on-screen displays such as video games, stock market quotations, computer generated graphics, and other fixed (non-moving) patterns can cause permanent damage to television receivers. Such "PATTERN BURNS" constitute misuse and are **NOT COVERED** by your MARANTZ Factory Warranty. When using the Picture-in-Picture function, the sub-picture should not be left permanently in one corner of the screen or a "PATTERN BURN" may develop over a long period of time.

PUBLIC VIEWING OF COPYRIGHTED MATERIAL

Public viewing of programs broadcast by TV stations and cable companies, as well as programs from other sources, may require prior authorization from the broadcaster or owner of the video program material.

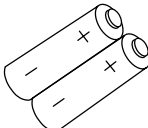
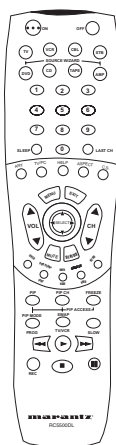

Check to make sure you have the following accessories before disposing of the packing material.

PARTS NAME	PART NO.	ILLUSTRATION
DRY BATTERY (R6P-AA) "AA" SIZE BATTERY	2784243	
RC5500DL REMOTE CONTROL	HL01646	

REMOTE CONTROL BATTERY INSTALLATION AND REPLACEMENT

1. Open the battery cover of the remote control by pushing the notched part of the cover with your fingers and pulling the cover off.
2. Insert two new "AA" size batteries for the remote control. When replacing old batteries, push them towards the springs and lift them out.
3. Match the batteries to the (+) and (-) marks in the battery compartment.
4. Replace the cover.

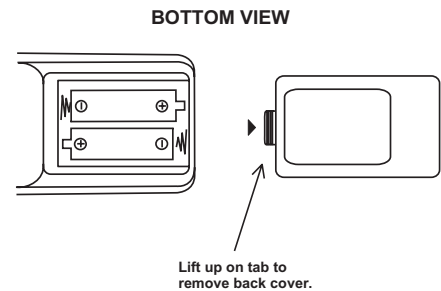

CAUTION: Danger of explosion if battery is incorrectly replaced. Replace with the same or equivalent type.

HOW TO SET UP YOUR NEW MARANTZ DLP™ REAR PROJECTION TV



ANTENNA

Unless your Rear Projection TV is connected to a cable TV system or to a centralized antenna system, a good outdoor color TV antenna is recommended for best performance. However, if you are located in an exceptionally good signal area that is free from interference and multiple image ghosts, an indoor antenna may be sufficient.

LOCATION

Select an area where sunlight or bright indoor illumination will not fall directly on the picture screen. Also, be sure that the location selected allows a free flow of air to and from the perforated back cover of the set.

To avoid cabinet warping, cabinet color changes, and increased chance of set failure, do not place the Rear Projection TV where temperatures can become excessively hot, for example, in direct sunlight or near a heating appliance, etc.

VIEWING

The major benefit of the MARANTZ Rear Projection Television is its large viewing screen. To see this large screen at its best, test various locations in the room to find the optimum spot for viewing.

The best picture is seen by sitting directly in front of the Rear Projection TV and about 10 to 18 feet from the screen. Picture brightness decreases as the viewer moves to the left and right of the receiver.

During daylight hours, reflections from outside light may appear on the screen. If so, drapes or screens can be used to reduce the reflection or the Rear Projection TV can be located in a different section of the room.

If the Rear Projection TV's audio output will be connected to a Hi-Fi system's external speakers, the best audio performance will be obtained by placing the speakers equidistant from each side of the receiver cabinet and as close as possible to the height of the picture screen center. For best stereo separation, place the external speakers at least four feet from the side of the Rear Projection TV, place the surround speakers to the side or behind the viewing area. Differences in room sizes and acoustical environments will require some experimentation with speaker placement for best performance.

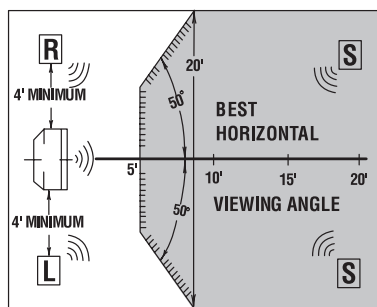
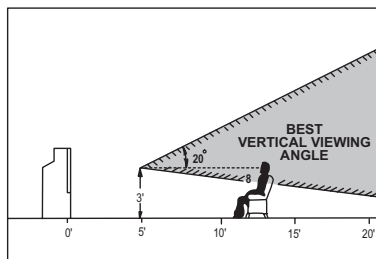

No.	Items	Notes
1	Lamp Explosion	This set has a 200W lamp. The lamp rarely breaks. If it does, it will make a pop noise.
2	On time	It takes time (17 seconds) to display picture on television compared to a conventional color television. LED at the front panel indicates the set is under power on condition. (See note on page 8)
3	Restart time	It takes about 60 seconds for the picture to re-appear, after quickly pressing power OFF then ON again. Three LEDs indicate the set is under power on condition. On: Three LED's blink alternately. Off: One LED blinks.
4	When power off	Fans will keep working for about 2 minutes after power OFF to cool down the lamp.
5	Lamp replacement	It is recommended that you replace the lamp every 4000 hours to obtain good picture brightness (This is not a guarantee that life time of a lamp is 4000 hours).
6	Bright and dark spot	This set has fixed pixel elements. There may be some dark/bright spots on the element. However, this is not a defect.
7	Streaks in Picture	Please set proper signal strength. You may see streaks in picture on some channels without proper antenna. Streaks may disappear when signal is strong. Place antenna and cable away from the AC power cord.
8	Bend, tilt	Due to varying signal content, you may see vertical or horizontal lines bend occasionally in PC mode. However, this phenomenon is not a defect. It's caused by a lack of picture content due to under-scanning in PC mode.
9	PC mode	This set provides the best picture quality in SVGA mode. It is recommended that you set your PC to SVGA mode. In OVERSCAN mode, top/bottom icon will be approximately 19% to 50% within the viewable area, and should be accessible to grab and click. Picture is overscanned when receiving XGA or higher resolution signals.
10	Burning	Please do not leave the TV set with still pictures like games, stock market quotes, and other non-moving pictures. Otherwise it may cause a pattern burn on the screen.
11	Protect Operation when power on	When the lamp is cooling down, the remote control does not respond within 15 seconds. LED at the front panel shows if your set accepts remote commands. When blinking is slow, your set is ready to accept remote commands.
12	Please do not move your set when it is on	There is a color wheel spinning at high revolution in the television set. It may be broken if you move your set before setting power off.
13	Input/PinP mode change	The television CPU sets picture blanking to hide unnecessary noise, until it becomes stable.
14	OSD position/size	OSD position/size change according to the picture aspect format, when watching a component (Y-PbPr) signal. SDTV (480P): OSD aspect changes when screen format is changed. HDTV (720P): OSD expands horizontally. (Both edges of OSD may be hidden according to circumstances.)
15	Cooling Fan/Color Wheel noise	Your DL5500 is designed with cooling fans to provide air circulation for the optical engine and a rotating component called the color wheel as part of the optical system. Under certain viewing conditions, as in a quiet room during scenes with no audio or low volume level, the sound generated by the fans or color wheel may be audible. This is a normal operating condition.



HOOK-UP CABLES AND CONNECTORS

Most video/audio connections between components can be made with shielded video and audio cables that have phono connectors. For best performance, video cables should use 75-Ohm coaxial shielded wire. Cables can be purchased from most stores that sell audio/video products. Below are illustrations and names of common connectors. Before purchasing any cables, be sure of the output and input connector types required by the various components and the length of each cable.

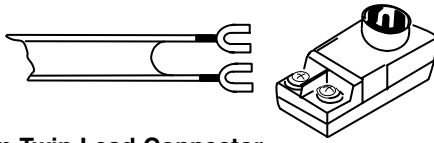

300-Ohm Twin Lead Connector

This outdoor antenna cable must be connected to an antenna adapter (300-Ohm to 75-Ohm).

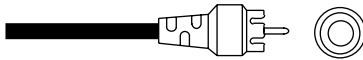

Phono Connector

Used on all standard video and audio cables which connect to inputs and outputs located on the Rear Projection Television's rear jack panel and front control panel.

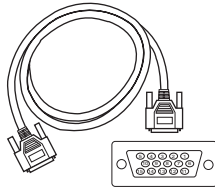

D-SUB MINI 15-Pin Cable (Optional)

This cable is used to connect a computer VGA output to the D-SUB input.

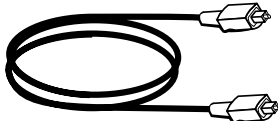

Optical Cable

This cable can be used to connect to a component with an Optical Audio Out jack, such as a Dolby* Digital DVD player or an HDTV Set Top Box. Use this cable for the best sound quality.



"F" Type 75-Ohm Coaxial Antenna Connector

For connecting RF signals (antenna or cable TV) to the antenna terminal on the Rear Projection Television.



S-VIDEO (Super Video) Connector (Optional)

This connector is used on camcorders, VCRs, and laserdisc players with an S-VIDEO feature in place of the standard video cable to produce a high quality picture.

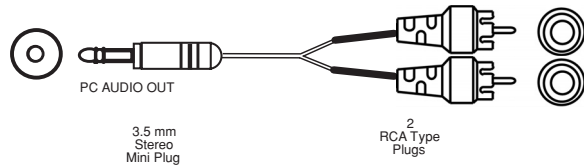

Stereo Cable (3.5 mm plug to 3.5 mm plug) (Optional)

This cable is used to connect from AUDIO OUT jack on the back of the computer's sound card to the PC1 AUDIO INPUT jack of the Rear Projection Television.

ANTENNA CONNECTIONS TO REAR JACK PANEL

VHF (75-Ohm) antenna/CATV (Cable TV)

When using a 75-Ohm coaxial cable system, connect the outdoor antenna or CATV coaxial cable to the ANT A (75-Ohm) terminal. If you have a second antenna or cable TV system, connect the coaxial cable to the ANT B terminal.

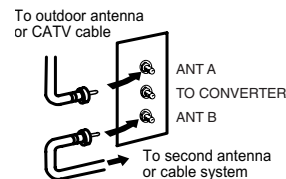

VHF (300-Ohm) antenna/UHF antenna

When using a 300-Ohm twin lead from an outdoor antenna, connect the VHF or UHF antenna leads to screws of the VHF or UHF adapter. Plug the adapter into the antenna terminal on the TV.

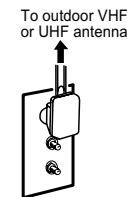

When both VHF and UHF antennas are connected

Attach an optional antenna cable mixer to the TV antenna terminal, and connect the cables to the antenna mixer. Consult your dealer or service store for the antenna mixer.

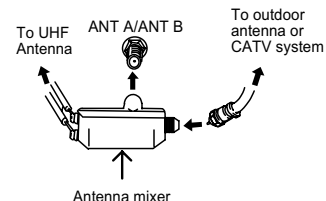

FRONT PANEL CONTROLS



FRONT VIEW

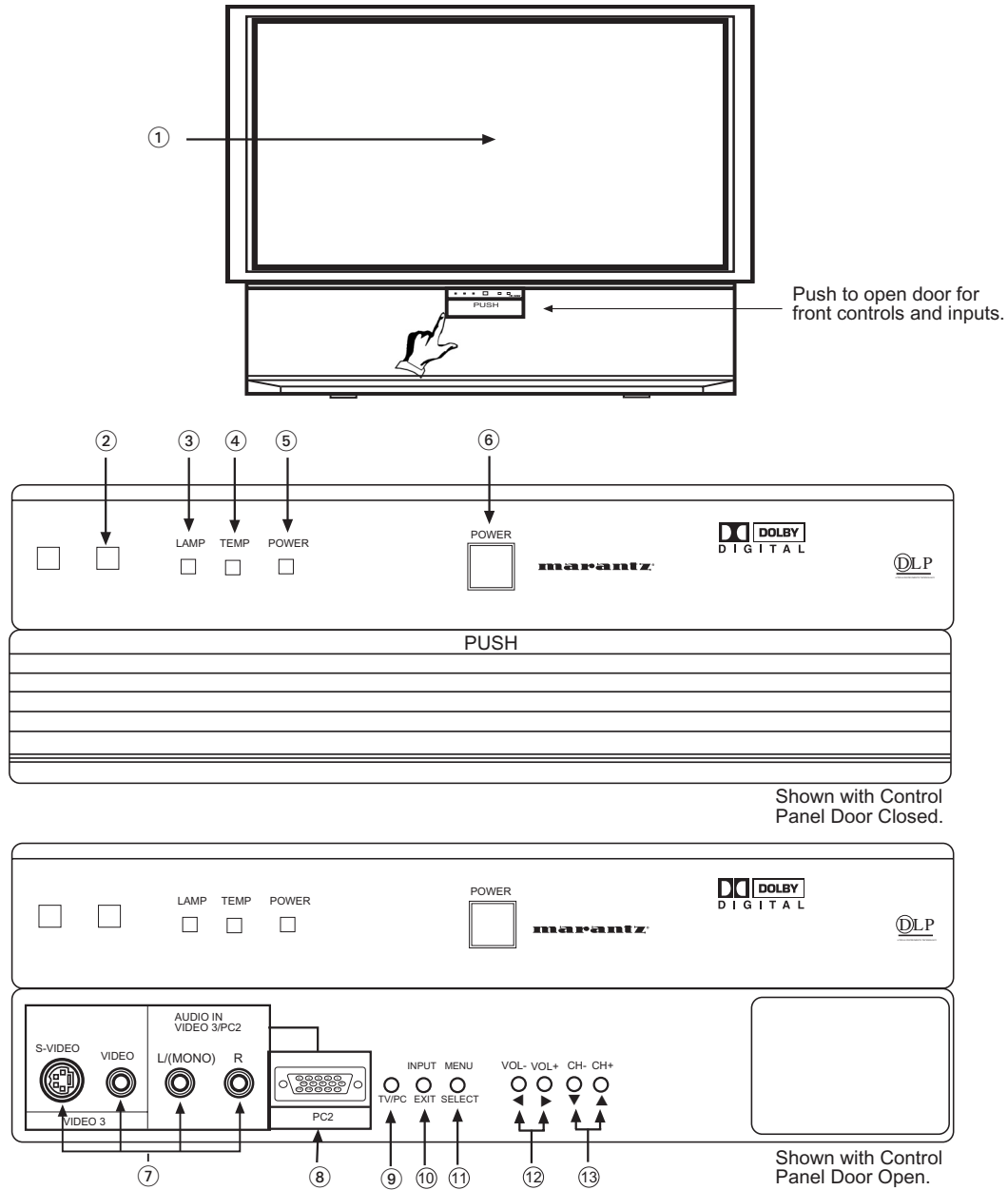

Push to open door for front controls and inputs.

Shown with Control Panel Door Closed.

Shown with Control Panel Door Open.

① REMOTE CONTROL Sensor

Point your remote at the screen when selecting channels, adjusting volume, etc. The remote control sensor is inside the screen.

② PERFECT PICTURE Sensor

The PERFECT PICTURE sensor will make automatic picture adjustments depending on the amount of light in the room to give the best picture. (see page 58)

③ LAMP Indicator - NORMAL OPERATION INDICATOR IS OFF

If light is lit, the lamp has failed. See page 79-82 for lamp replacement procedure. Consult your Marantz dealer for proper part. If light is blinking, lamp cover is not assembled securely after replacement.

④ TEMP Indicator

This light is off during normal operation.

If this indicator is lit, the optic unit is too hot. If this indicator is blinking, the cooling fan has stopped. Please call service.



FRONT PANEL CONTROLS

⑤ POWER Light

This light is on during normal operation.

Light Blinking Slowly (2 seconds): Rear Projection Television lamp is cooling down. It takes 12-15 seconds to warm up and about 2 minutes to cool down.

⑥ POWER Button

Press this button to turn the TV on or off.

⑦ FRONT INPUT JACKS (for VIDEO: 3 and PC2 AUDIO)

Use these audio/video jacks for a quick hook-up from a camcorder or VCR to instantly view your favorite show or new recording. Press the INPUT button until VIDEO: 3 appears in the top right corner of the TV screen. If you have mono sound, insert the audio cable into the left audio jack. VIDEO: 3 audio input jacks can be used for PC2 audio when a PC is connected to front input VIDEO: 3 jack. When using S-Video cable on the front panel, make sure the arrow (↑) marking on the S-Video cable points to the left, to properly insert the S-Video cable into your television.

⑧ PC 2 (Front)

Use this 15 pin D-Sub input for a “quick” hook up from your PC connection.

⑨ TV/PC Button

Press this button to switch from TV, PC 1 and PC 2. Your selection is shown in the top right corner of the screen.

⑩ INPUT/EXIT Button

Press this button to select the current antenna source, VIDEO: 1, 2, 3 or alternate antenna source. Your selection is shown in the top right corner of the screen. This button also serves as the EXIT button when in MENU mode.

NOTE: COMPONENT INPUT takes priority over S-VIDEO input, and S-VIDEO input takes priority over VIDEO input.

⑪ MENU Button

This button allows you to enter the MENU, making it possible to set TV features to your preference without using the remote. This button also serves as the SELECT button when in menu mode.

⑫ VOLUME Level

Press these buttons for your desired sound level. The volume level will be displayed on the TV screen. These buttons also serve as the cursor left (◀) and right (▶) buttons when in MENU mode.

⑬ CHANNEL Selector

Press these buttons until the desired channel appears in the top right corner of the TV screen. These buttons also serve as the cursor down (▼) and up (▲) buttons when in MENU mode.

NOTES:

1.	INDICATOR	INDICATION	MEANING	ACTION
	LAMP LED	LIGHT ON	NO LAMP LIGHT or BROKEN LAMP	Need to exchange if LAMP still does not light by Power On again. Check assembly condition of LAMP UNIT
		BLINKING	WRONG LAMP UNIT ASSEMBLY	
	TEMP LED	LIGHT ON	Too Hot inside the OPTIC unit	Call Service
		BLINKING	COOLING FAN STOPPED	
	POWER	LIGHT ON	NORMAL OPERATION	
		SLOWLY BLINKING	COOL DOWN	

2. If the LAMP, TEMP, and POWER LED are blinking in the order below, the Rear Projection Television is warming up.





FRONT PANEL JACKS AND CONNECTIONS

The front panel jacks are provided as a convenience to allow you to easily connect a VCR, PC or camcorder as shown in the following examples:

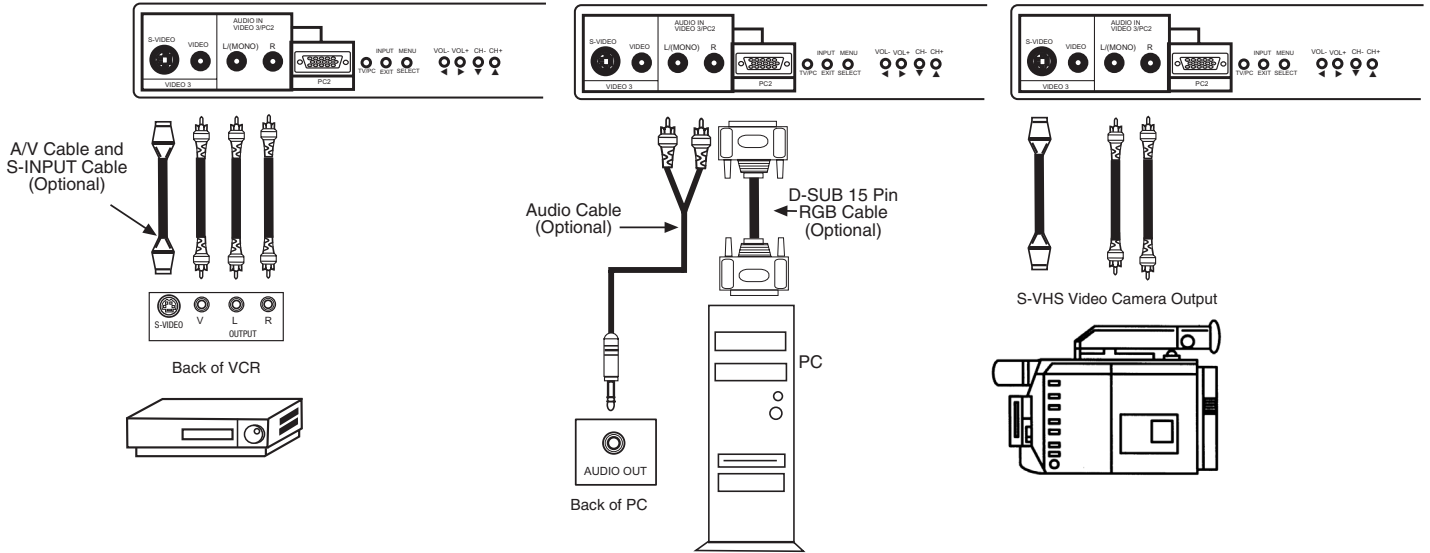

NOTE: Completely insert connection cord plugs when connecting to front panel jacks. If you do not, the played back picture may be abnormal. If you have an S-VHS VCR, use the S-INPUT cable in place of the standard video cable. If you have a mono VCR, insert the audio cable into the left audio jack of your TV. VIDEO 3 audio can be used for PC 2 audio when a PC 2 is connected.

NOTE: Optional adapter for *Apple® Macintosh® computers. If the optional AESP model G301/U Macintosh to VGA® adapter connector is configured and connected between Macintosh video out and the Rear Projection Television video in, the Macintosh is “forced” to boot in 640 x 480/60 Hz or 800 x 600/60 Hz mode (set mode) because the operational adapter correctly manipulates the Macintosh sense pins.

For the optional adapter to work, its DIP switch settings should be # 2, 3, 6, 7 = ON and # 1, 4, 5, 8, 9, 10 = OFF.

See below: Example - See Switch Instructions for details.

Mode 5 = 2367 (SVGA 800 x 600/60 Hz configuration)
(VGA 640 x 480/60 Hz configuration)

Composite Separate Sync

SW1	SW2	SW3	SW4	SW5	SW6	SW7	SW8	SW9	SW10
OFF	ON	ON	OFF	OFF	ON	ON	OFF	OFF	OFF

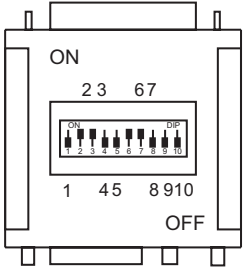



REAR VIEW

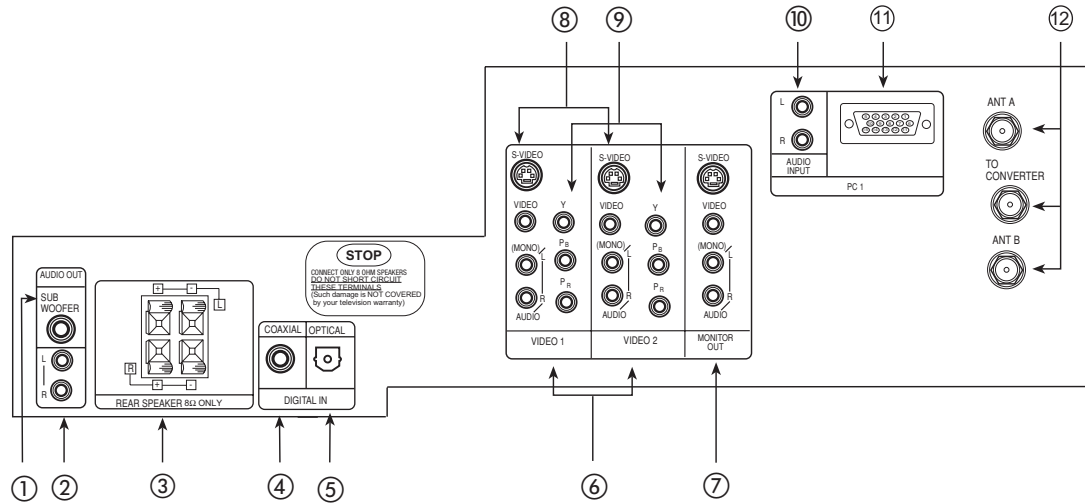

① SUB WOOFER Output

This jack provides variable audio output to a sub-woofer accessory. With this connection, the audio can be controlled by the television's main volume. This feature can be turned on and off in the THEATER-SPEAKER SETUP menu.

② AUDIO OUTPUT L/R

These jacks provide variable audio output to a separate stereo amplifier. With this connection, the audio to the stereo can be controlled by the television's main volume. Use these jacks for the external audio amplifier.

③ REAR SPEAKER Output Terminals

These terminals are used to connect external speakers, which are used for the surround sound feature. The volume level is controlled by the television's main volume. These speaker output terminals can be turned on and off in the THEATER-SPEAKER SETUP menu. Use speakers with 8-Ohm impedance only.

④ DIGITAL IN (Coaxial Input)

This jack provides high quality audio input from a Dolby Digital DVD player or HDTV Set Top Box. This input can be used for VIDEO: 1 or VIDEO: 2 audio, as selected in the THEATER-INPUT SOURCE menu. (see page 65)

⑤ DIGITAL IN (Optical Input)

This jack provides high quality audio input from a Dolby Digital DVD player or HDTV Set Top Box. Use a digital optical cable to connect your TV to a compatible device. This input can be used for VIDEO: 1 or VIDEO: 2 audio, as selected in the THEATER-INPUT SOURCE menu. (see page 65).

NOTE: This TV's optical digital input jack fully complies with the international standard governing this type of jack (IEC958), and is designed for connection to a Dolby Digital or PCM from DVD Player or HDTV Set Top Box. Older equipment, some of which is not fully compliant with IEC958, may not be compatible with the Dolby Digital bit stream. Such a connection using anything other than Dolby Digital AC-3 or PCM bit stream could create a high noise level, causing damage to your speakers.



REAR PANEL JACKS

⑥ AUDIO/VIDEO 1, 2

The INPUT button on the front panel will step through each signal source input each time it is pressed. The VID1~VID3 buttons on the remote control will select each video source each time they are pressed. Use the audio and video inputs to connect external devices, such as VCRs, camcorders, laserdisc players, DVD players etc. (If you have mono sound, insert the audio cable into the left audio jack.)

NOTE: You may use VIDEO, S-VIDEO, or COMPONENT: Y-P_BP_R Inputs to connect to VIDEO 1, 2. But note that only one of these may be used at a time.

COMPONENT INPUT takes priority over S-VIDEO input and S-VIDEO input takes priority over VIDEO input.

⑦ MONITOR OUT

These jacks provide fixed audio and video signals which are used for recording. Use the S-VIDEO Output for high quality video output. There is no MONITOR OUT when using COMPONENT VIDEO INPUT.

NOTE: S-VIDEO Output may be used for recording, only when the input is of S-VIDEO type.

⑧ S-VIDEO Inputs 1 and 2

Inputs 1 and 2 provide S-VIDEO (Super Video) jacks for connecting equipment with S-VIDEO output capability.

⑨ COMPONENT VIDEO Y-P_BP_R INPUT

Y-P_BP_R jacks provide for connecting equipment with this capability, such as a DVD player.

NOTE: DO NOT connect standard VIDEO or S-VIDEO when using Y-P_BP_R input.

Your component outputs may be labeled Y, B-Y, and R-Y. In this case, connect the components B-Y output to the TV's P_B input and the components R-Y output to the TV's P_R input.

It may be necessary to adjust TINT or turn AUTO COLOR-ON to obtain optimum picture quality when using the Y-P_BP_R inputs. (see pages 57 and 58)

To ensure no copyright infringement, the MONITOR OUT output will be abnormal, when using the Y-P_BP_R jacks.

When using the Y-P_BP_R jacks, Component Y-P_BP_R signal will be viewed as a blank PIP sub-picture. (see page 28)

⑩ PC 1 AUDIO INPUT

Connect external devices for audio in PC mode. (see page 71)

⑪ PC 1 D-SUB INPUT

Use this 15-pin D-Sub Input for your PC connection. (see page 68)

⑫ ANTENNA Input/Output

The remote control allows you to switch between two separate 75-Ohm RF antenna inputs, ANT A and ANT B. ANT A input can be displayed as a main picture or sub-picture. ANT B can only be displayed as a main picture. (ANT B cannot be displayed as a sub-picture.) The antenna output labeled "TO CONVERTER" allows the ANT A connection to pass directly to a different source, such as a cable box, only when ANT B is displayed as a main picture.



TIPS ON REAR PANEL CONNECTIONS

NOTE: Turn off the Rear Projection Television and the PC before connecting or disconnecting any cables.

TIPS ON REAR PANEL CONNECTIONS

S-VIDEO connections are provided for high performance laserdisc players, VCRs etc. that have this feature. Use these connections in place of the standard video connection if your device has this feature.

If your device has only one audio output (mono sound), connect it to the left audio jack on the television.

Refer to the operating guide of your other electronic equipment for additional information on connecting your hook-up cables.

A single VCR can be used for VCR#1 and VCR#2, but note that a VCR cannot record its own video or line output. (INPUT 1 in example on page 13) Refer to your VCR operating guide for more information on line input-output connection.

You may use VIDEO, S-VIDEO, or COMPONENT: Y-P_BP_R inputs, but note that only one of these may be used at a time.

Connect only 1 component to each input jack.

COMPONENT: Y-P_BP_R connections are provided for high performance components, such as DVD players. Use these connections in place of the standard video connection if your device has this feature.

When using the Y-P_BP_R input jacks, connect your components audio output to the TV's Left and Right audio input jacks.

Your component outputs may be labeled Y, B-Y, and R-Y. In this case, connect the components B-Y output to the TV's P_B input and the components R-Y output to the TV's P_R input.

It may be necessary to adjust TINT or turn AUTO COLOR-ON to obtain optimum picture quality when using the Y-P_BP_R inputs. (see pages 57 and 58)

To ensure no copyright infringement, the MONITOR OUT output will be abnormal, when using the Y-P_BP_R jacks.

REAR PANEL JACKS



TYPICAL FULL-FEATURE SETUP

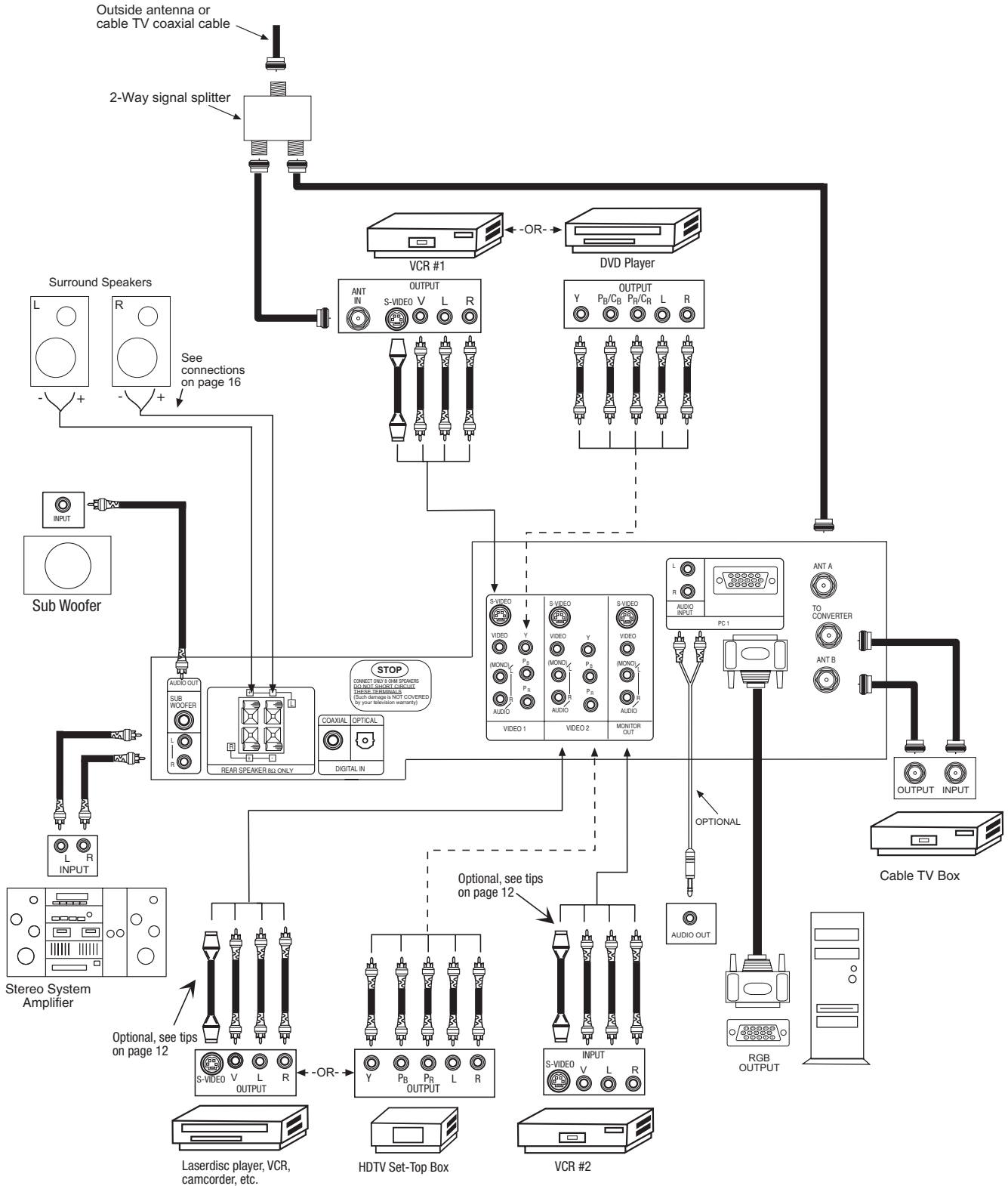

- NOTES:**
1. Connect only 1 component to each input jack.
 2. Follow connections that pertain to your personal entertainment system.



REAR SPEAKER TERMINAL CONNECTIONS

CONNECT AFTER TURNING THE POWER OF THE TV OFF.

Push in the Right Speaker button and insert the positive (+) lead wire into the hole next to the button. Once the wire is in place, pull the red button back to original position and the wire is locked into place. In the same manner, push in the Right Speaker black button and insert the negative (-) lead wire. Repeat this procedure for the Left Speaker.



CAUTION: Do not short speaker terminal, (do not connect a wire directly across any two terminals). This could cause damage to your audio outputs or TV.

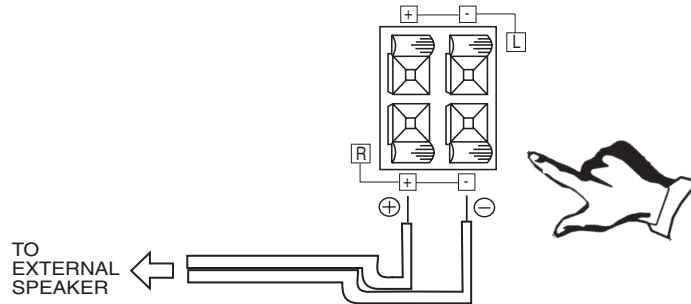

CAUTION: Do not connect speakers simultaneously to the REAR SPEAKER terminal of the Rear Projection TV and an external amplifier. This could damage both the TV and the speakers. Your TV was designed to use 8-Ohm speakers only. Any other type may degrade the audio performance of your entertainment system.

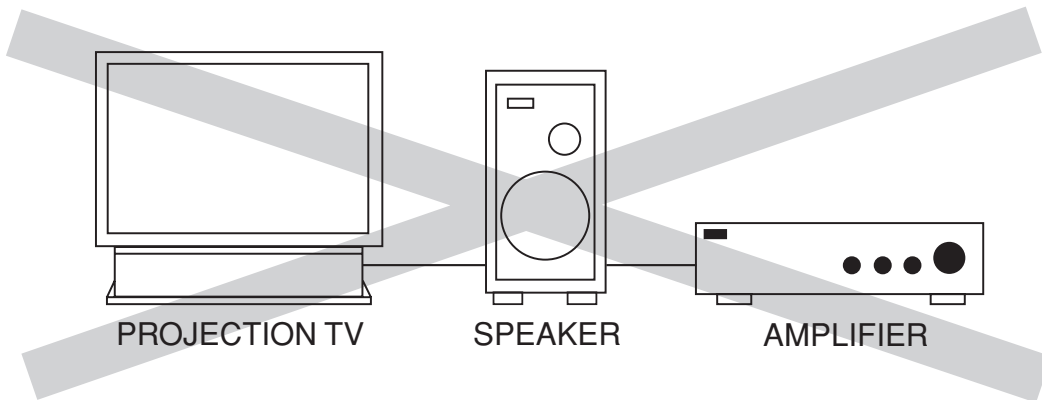



CONNECTING EXTERNAL AUDIO SOURCES

CONNECTING EXTERNAL AUDIO AMPLIFIER

To control the audio level of an external audio amplifier with the remote control, connect the system as shown below.

REAR PANEL OF TELEVISION

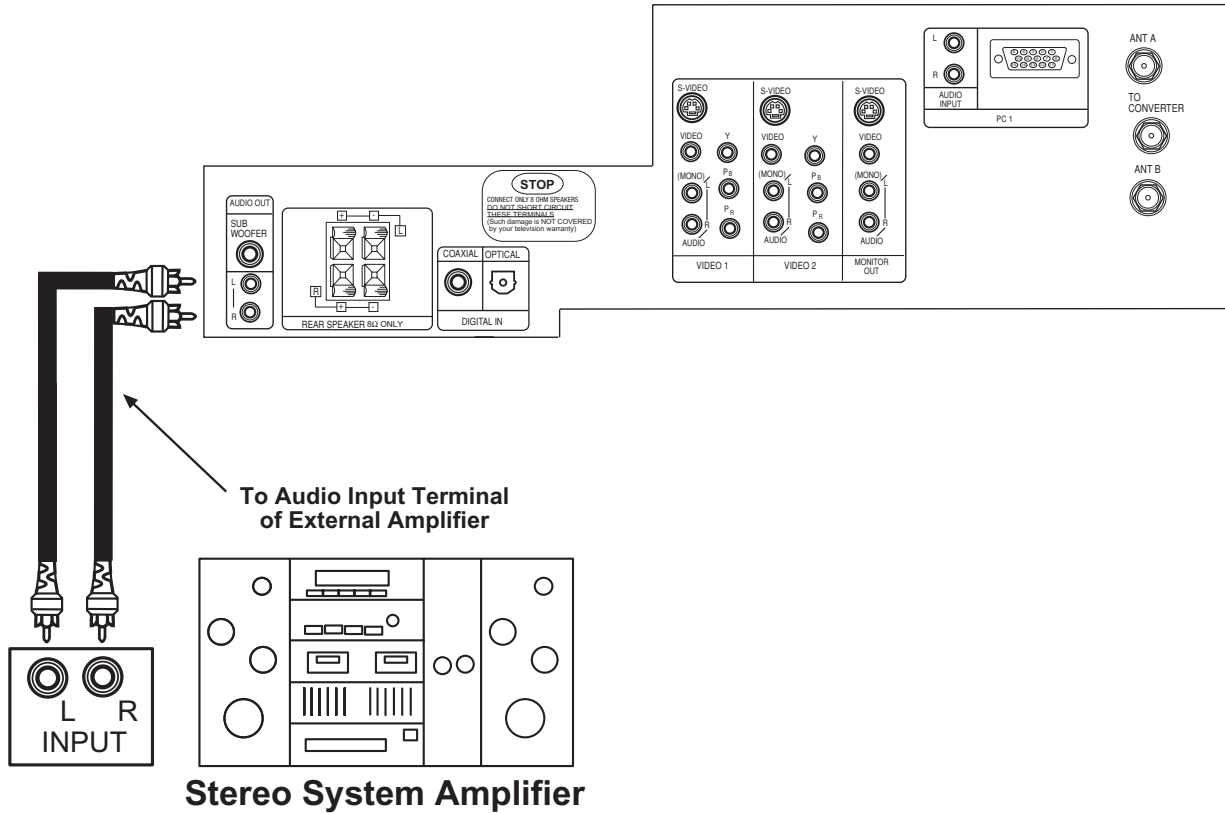

NOTE: To prevent damage to the speaker and distorted sound, set the volume control of the audio amplifier lower and adjust the sound using the remote control of the TV set.



AUDIO SYSTEM SETUP

Match the numbers below to the diagrams for speaker placement and refer to the table on page 17 for the different surround sound requirements. (See page 62 and 63 for SURROUND functions.)

- ① The television's internal speakers.
- ② The television's internal center channel speaker, which is on only when the television is in SURROUND-STADIUM, SURROUND-ROCK ARENA, SURROUND-JAZZ CLUB, SURROUND-PRO LOGIC, or SURROUND-DOLBY DIGITAL mode.
- ③ These speakers are connected to a separate audio amplifier. Use the AUDIO TO HI-FI output on the TV.
- ④ These speakers are connected to a rear speaker 8-Ohm output on the TV.
- ⑤ This sub woofer is connected to the SUB WOOFER output on the TV.

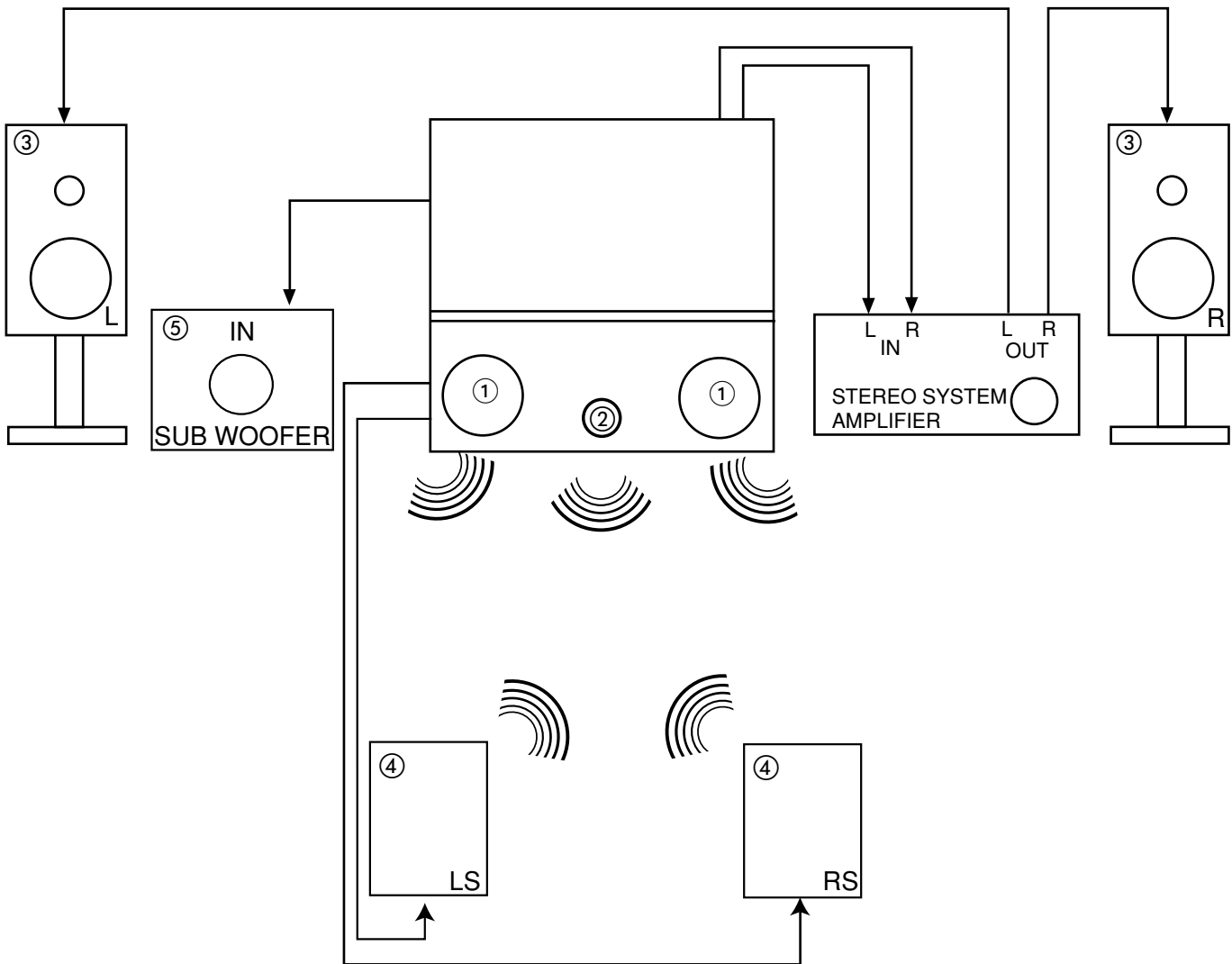

AUDIO SYSTEM SETUP



SURROUND FEATURE	REQUIRED CONNECTION	OPTIONAL CONNECTION	EFFECT
OFF	①	③ ⑤	Receive mono and stereo sound.
STADIUM	① ② ④	③ ⑤	Listener has feeling of being at a stadium.
ROCK ARENA	① ② ④	③ ⑤	Listener has feeling of being at a rock concert.
JAZZ CLUB	① ② ④	③ ⑤	Listener has feeling of being at a jazz club.
DOLBY PRO LOGIC	① ② ④	③ ⑤	Movie theater reproduction, with separate left, center, right, and surround channels.
DOLBY DIGITAL	① ② ④ ⑤	③	To be used with a DVD player or HDTV Set Top Box with Dolby Digital output. This provides up to 6 channels of all-digital surround sound. There are 3 full-range channels for the front (FL, C, FR) plus separate, full-range left and right surround channels (SL, SR). The sixth channel is Low Frequency Effects for a sub woofer (SW), supplying those room-shaking rumbles experienced in the best movie theaters.

When left and right speakers are connected (③), the internal speakers (①) can be disabled, creating better separation between left, center and right channels. The center channel audio will be heard from (②), this speaker cannot be disabled.



CONNECTING EXTERNAL VIDEO SOURCES

The exact arrangement you use to connect the VCR, camcorder, laserdisc player, and DVD player to your TV set is dependent on the model and features of each component. Check the owner's manual of each component for the location of video and audio inputs and outputs.

The following connection diagrams are offered as suggestions. However, you may need to modify them to accommodate your particular assortment of components and features. For best performance, video and audio cables should be made from coaxial shielded wire.

Before Operating External Video Source

The input mode is changed every time the INPUT button on the Front Panel is pressed as shown below. The VID1~VID3 buttons on the remote control will select each video source each time they are pressed. The ANT button on the remote control will select between ANT A and ANT B. Connect an external source to the INPUT terminals, then press the INPUT button as necessary to view the input source. (See page 26)

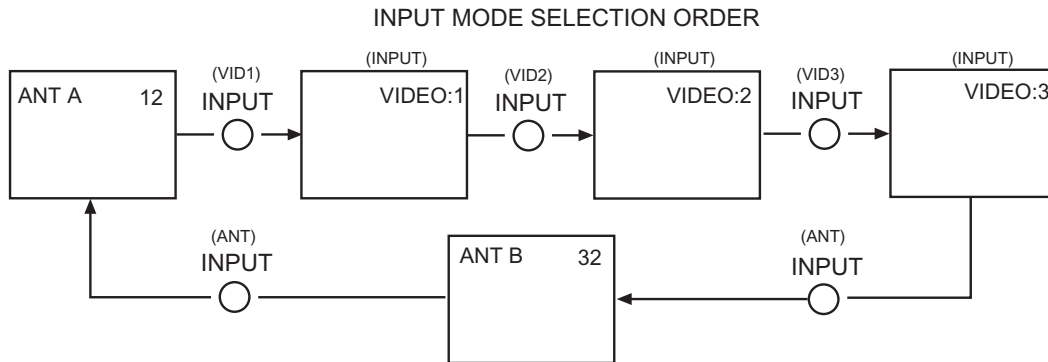

NOTE: When the Rear Projection TV is set to VIDEO and a video signal is not received from the VIDEO INPUT jack on the back panel of the Rear Projection TV (i.e., VCR/laserdisc player, etc. is not connected or the video device is OFF), the TV set will appear to be OFF.

CONNECTING A MONAURAL AUDIO VCR OR LASERDISC PLAYER

1. Connect the cable from the VIDEO OUT of the VCR or the laserdisc player to the VIDEO input jack on the TV set below.
2. Connect the cable from the AUDIO OUT of the VCR or the laserdisc player to the VIDEO input (MONO)/L(AUDIO) jack.
3. Press the VID1~VID3 button on the Remote Control to view the program from the VCR or the laserdisc player. The VIDEO icon disappears automatically after approximately eight seconds.
4. Press the ANT button to return to the previous channel.

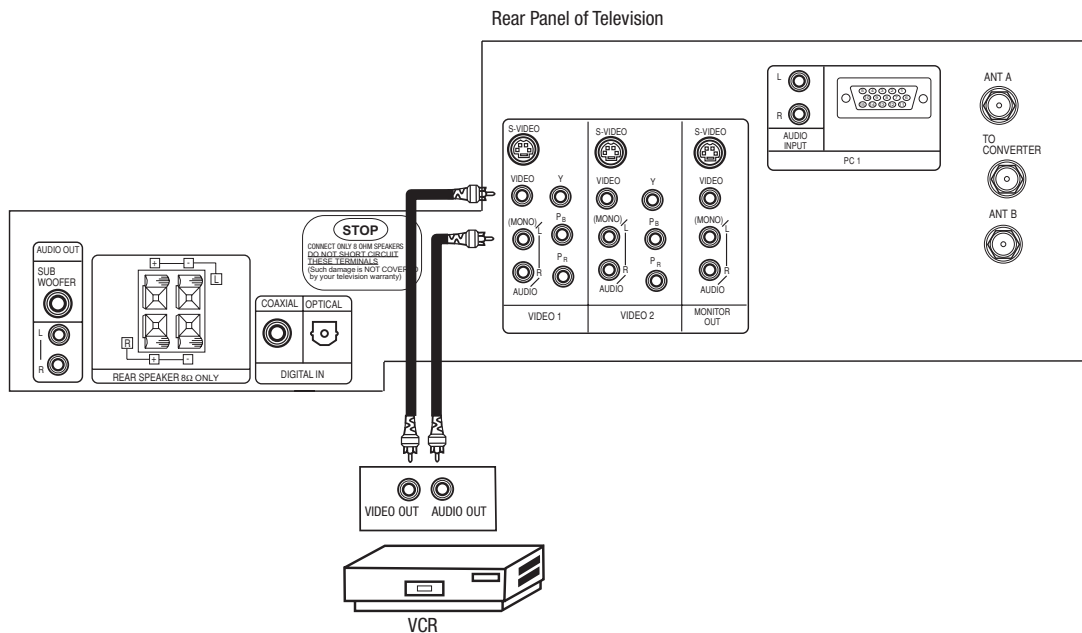

CONNECTING EXTERNAL VIDEO SOURCES



CONNECTING A STEREO VCR OR STEREO LASERDISC PLAYER

1. Connect the cable from the VIDEO OUT of the VCR or the laserdisc player to the VIDEO input (VIDEO) jack, as shown on the TV set below.
2. Connect the cable from the AUDIO OUT R of the VCR or the laserdisc player to the VIDEO input (AUDIO/R) jack.
3. Connect the cable from the AUDIO OUT L of the VCR or the laserdisc player to the VIDEO input (AUDIO/L) jack.
4. Press the VID1~VID3 button to view the program from the VCR or laserdisc player. The VIDEO icon disappears automatically after approximately eight seconds.
5. Press the ANT button to return to the previous channel.

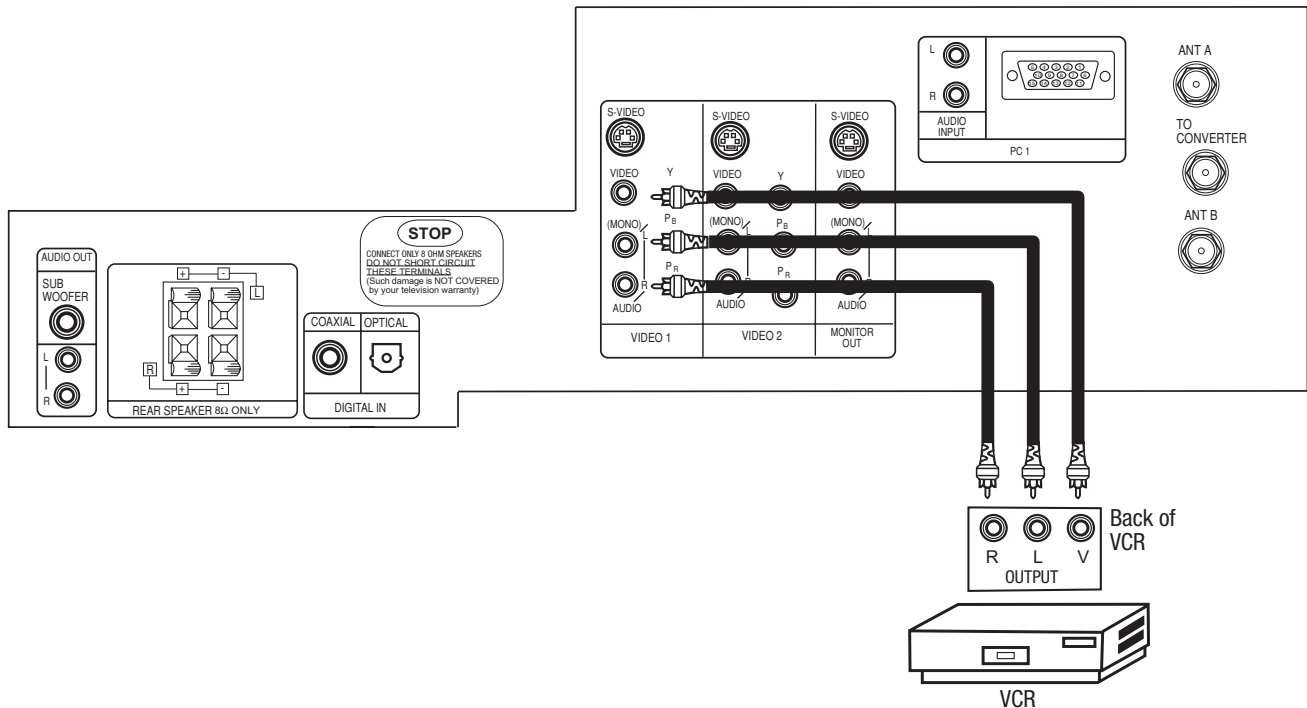

- NOTES:**
1. Completely insert the connection cord plugs when connecting to rear panel jacks. The picture and sound that is played back will be abnormal if the connection is loose.
 2. A single VCR can be used for VCR #1 and VCR #2, but note that a VCR cannot record its own video or line output. (INPUT: 1 in example on page 13) Refer to your VCR operating guide for more information on line input-output connections.



CONNECTING EXTERNAL VIDEO SOURCES

CONNECTING AN S-VIDEO VCR OR LASERDISC PLAYER

1. Connect the cable from the S-VIDEO OUT of the VCR or the laserdisc player to the VIDEO input (S-VIDEO) jack, as shown on the TV set below.
2. Connect the cable from the AUDIO OUT R of the VCR or the laserdisc player to the VIDEO input (AUDIO/R) jack.
3. Connect the cable from the AUDIO OUT L of the VCR or the laserdisc player to the VIDEO input (AUDIO/L) jack.
4. Press the VID1~VID3 button to view the program from the VCR or laserdisc player. The VIDEO icon disappears automatically after approximately eight seconds.
5. Press the ANT button to return to the previous channel.

Rear Panel of Television

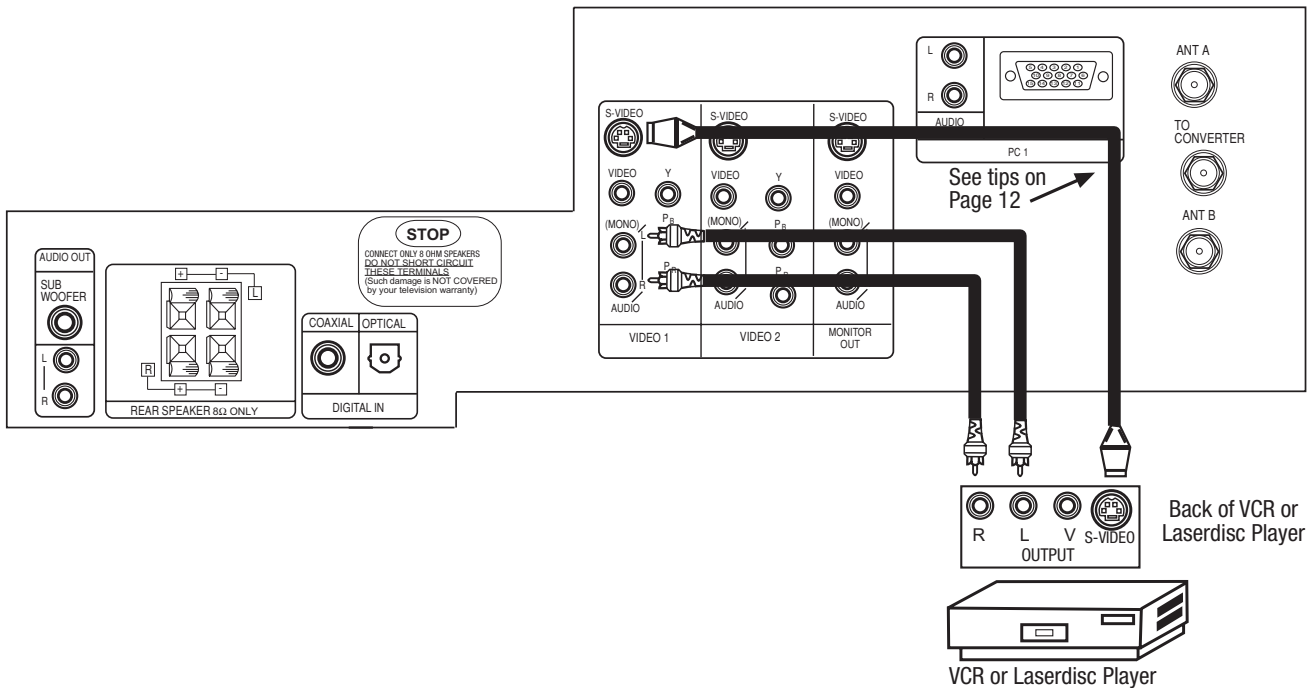

NOTES:

1. Completely insert the connection cord plugs when connecting to rear panel jacks. The picture and sound that is played back will be abnormal if the connection is loose.
2. A single VCR can be used for VCR #1 and VCR #2, but note that a VCR cannot record its own video or line output. (INPUT: 1 in example on page 13) Refer to your VCR operating guide for more information on line input-output connections.

CONNECTING EXTERNAL VIDEO SOURCES



CONNECTING A STEREO LASERDISC/DVD PLAYER OR HDTV SET TOP BOX TO VIDEO INPUTS 1 OR 2 COMPONENT: Y-P_BP_R.

1. Connect the cable from the Y OUT of the Laserdisc/DVD player or HDTV set top box to the VIDEO input (Y) jack, as shown on the TV set below.
2. Connect the cable from the C_B/P_B OUT or B-Y OUT of the Laserdisc/DVD player or HDTV set top box to the VIDEO input (P_B) jack.
3. Connect the cable from the C_R/P_R OUT or R-Y OUT of the Laserdisc/DVD player or HDTV set top box to the VIDEO input (P_R) jack.
4. Connect the cable from the AUDIO OUT R of the Laserdisc/DVD player or HDTV set top box to the VIDEO input (AUDIO/R) jack.
5. Connect the cable from the AUDIO OUT L of the Laserdisc/DVD player or HDTV set top box to the VIDEO input (AUDIO/L) jack.
6. Press the VID1~VID3 button, to view the program from the Laserdisc/DVD player or HDTV set top box. The VIDEO icon disappears automatically after approximately eight seconds.
7. Press the ANT button to return to the previous channel.

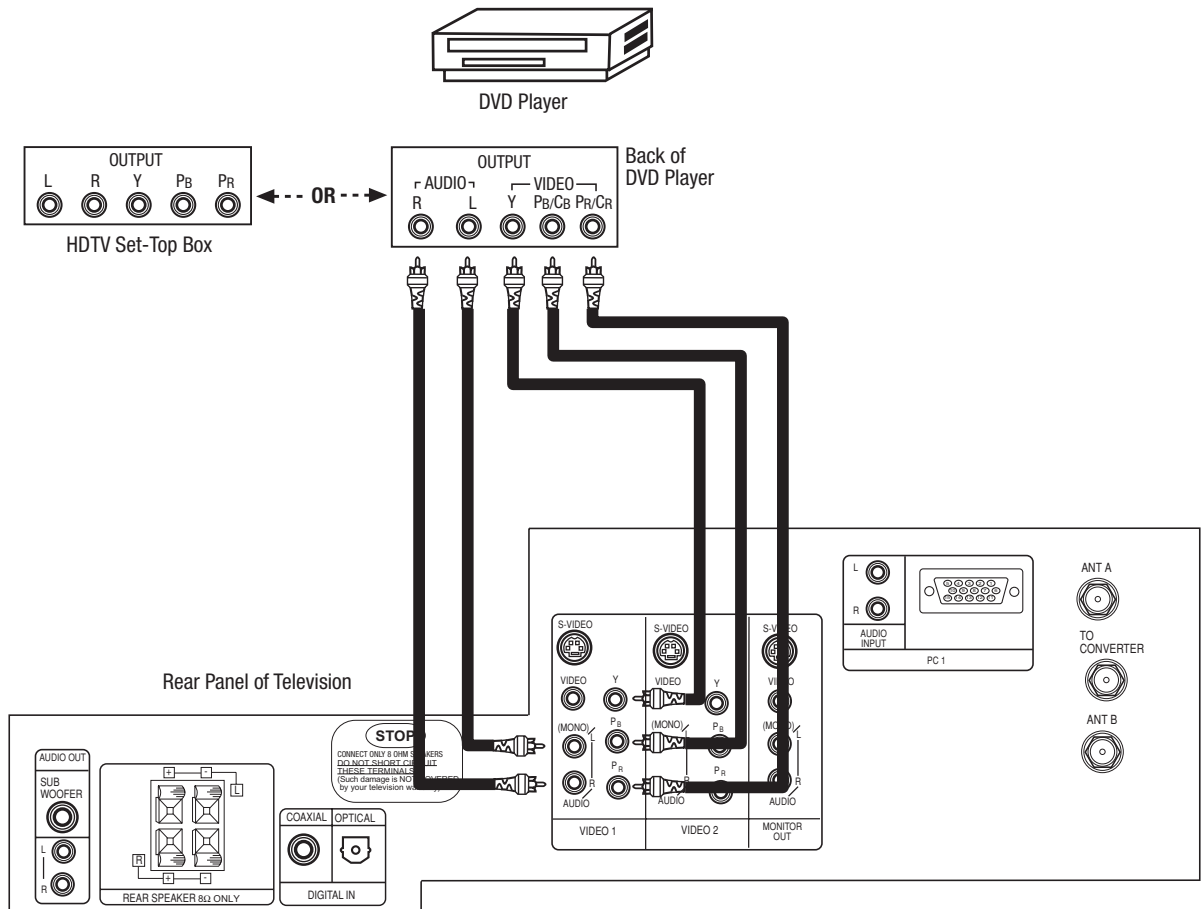

- NOTE:**
1. Completely insert the connection cord plugs when connecting to rear panel jacks. The picture and sound that is played back will be abnormal if the connection is loose.
 2. See page 12 for tips on REAR PANEL CONNECTIONS.



CONNECTING EXTERNAL VIDEO SOURCES

CONNECTING A DVD PLAYER OR HDTV SET TOP BOX WITH DOLBY DIGITAL OPTICAL OUTPUT TO VIDEO INPUTS 1 or 2 COMPONENT: Y-P_BP_R

1. Connect the cable from the Y OUT of the DVD player or HDTV Set Top Box to the VIDEO input (Y) jack, as shown on the TV set below.
2. Connect the cable from the C_B/P_B OUT or B-Y OUT of the DVD player or HDTV Set Top Box to the VIDEO input (P_B) jack.
3. Connect the cable from the C_R/P_R OUT or R-Y OUT of the DVD player or HDTV Set Top Box to the VIDEO Input (P_R) jack.
4. Connect the cable from the OPTICAL OUTPUT of the DVD player or HDTV Set Top Box to the OPTICAL input jack.
5. Press the VID1~VID3 button, to view the program from the DVD player or HDTV Set Top Box. The VIDEO icon disappears automatically after approximately eight seconds.
6. Press the ANT button to return to the previous channel.

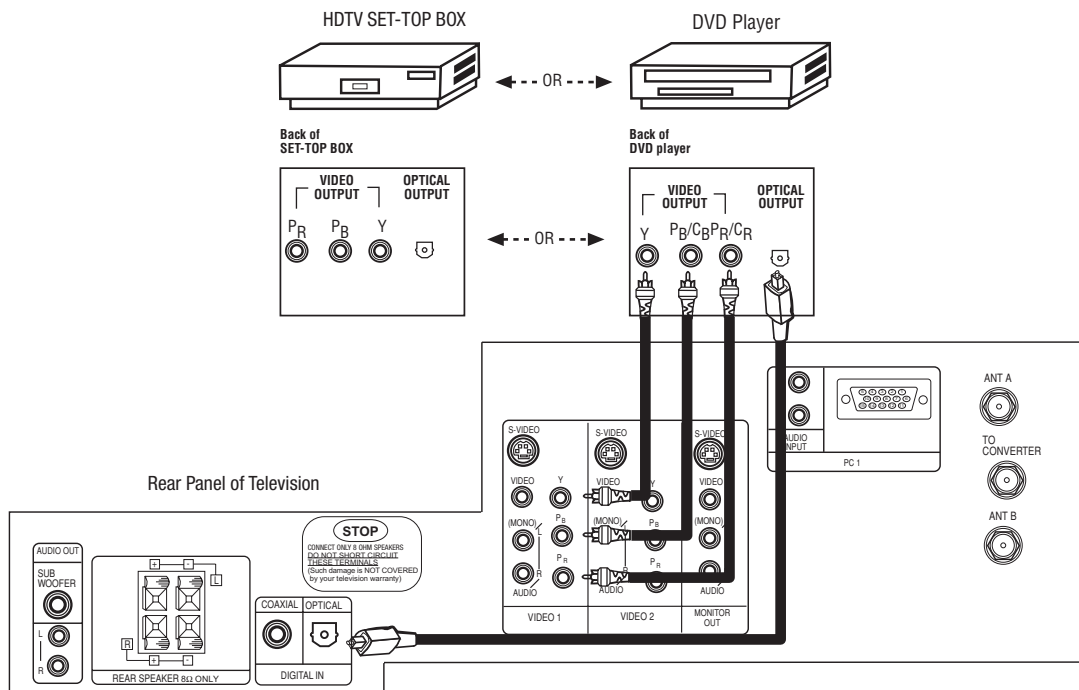

- NOTES:**
1. Completely insert the connection cord plugs when connecting to rear panel jacks. The picture and sound that is played back will be abnormal if the connection is loose.
 2. See page 12 for tips on REAR PANEL CONNECTIONS.
 3. If your device is connected to VIDEO 1 component jacks, make sure to select VID1-OPTICAL from the THEATER-INPUT SOURCE menu. If it is connected to VIDEO 2 component jacks, make sure to select VID2-OPTICAL from the THEATER-INPUT SOURCE menu.



CONNECTING EXTERNAL VIDEO SOURCES

CONNECTING A DVD PLAYER OR HDTV SET TOP BOX WITH DOLBY DIGITAL COAXIAL OUTPUT TO VIDEO INPUT COMPONENT: Y-P_BP_R

1. Connect the cable from the Y OUT of the DVD player or HDTV Set Top Box to the VIDEO input (Y) jack, as shown on the TV set below.
2. Connect the cable from the C_B/P_B OUT or B-Y OUT of the DVD player or HDTV Set Top Box to the VIDEO input (P_B) jack.
3. Connect the cable from the C_R/P_R OUT or R-Y OUT of the DVD player or HDTV Set Top Box to the VIDEO input (P_R) jack.
4. Connect the cable from the COAXIAL OUTPUT of the DVD player or HDTV Set Top Box to the COAXIAL input jack.
5. Press the VID1~VID3 button, to view the program from the DVD player or HDTV Set Top Box. The VIDEO icon disappears automatically after approximately eight seconds.
6. Press the ANT button to return to the previous channel.

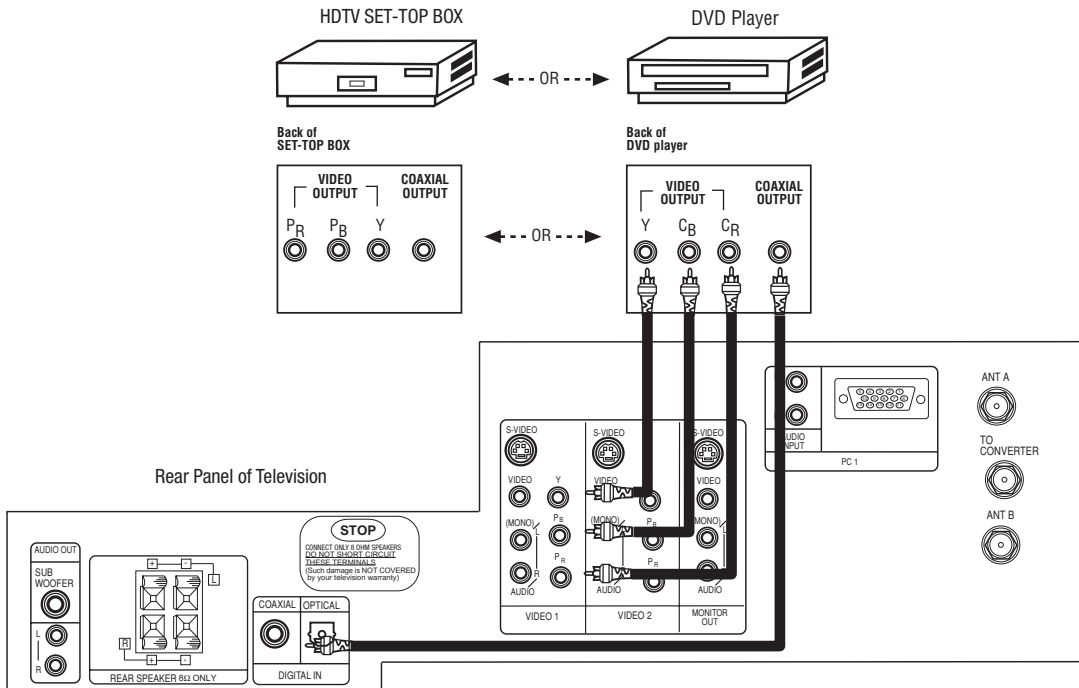

NOTE:

1. Completely insert the connection cord plugs when connecting to rear panel jacks. The picture and sound that is played back will be abnormal if the connection is loose.
2. See page 12 for tips on REAR PANEL CONNECTIONS.
3. If your device is connected to VIDEO 1 component jacks, make sure to select VID1-COAXIAL (DIGITAL) from the THEATER-INPUT SOURCE menu. If it is connected to VIDEO 2 component jacks, make sure to select VID2-COAXIAL (DIGITAL) from the THEATER-INPUT SOURCE menu.



THE REMOTE CONTROL

In addition to controlling all the functions on your MARANTZ Projection TV, the new remote control is designed to operate different types of VCRs, CATV (Cable TV) converters, satellite receivers, DVD players, and other audio/video equipment with one touch. Basic operation keys are grouped together in one area.

To operate your TV, point the remote control at the remote sensor of the TV and press the TV button. The TV button will blink, indicating that the remote will now control your television.

To operate your VCR, point the remote at the remote sensor of the VCR and press the VCR button. The VCR button will blink, indicating that the remote will now control your VCR. (See page 31 for instructions on how to program the remote to control your VCR.)

To operate your cable box, point the remote at the remote sensor of the cable box and press the CABLE (CBL) button. The CBL button will blink, indicating that the remote will now control your cable box. (See page 32 for instructions on how to program the remote to control your cable box.)

To operate your set-top-box or satellite receiver, point the remote at the remote sensor of the set-top-box/satellite receiver and press the SET-TOP-BOX (STB) button. The STB button will blink, indicating that the remote will now control your set-top-box/satellite receiver. (See page 33 for instructions on how to program the remote to control your set-top-box/satellite receiver.)

To operate your DVD player, point the remote at the remote sensor of the DVD player and press the DVD button. The DVD button will blink, indicating that the remote will now control your DVD player. (See page 34 for instruction on how to program the remote to control your DVD player.)

To operate additional audio/video equipment, point the remote at the remote sensor of the component you wish to control and press the CD, TAPE or AMP button. This button will blink, indicating that the remote will now control the desired component. (See page 35 for instructions on how to program the remote to control additional Audio/Video equipment.)

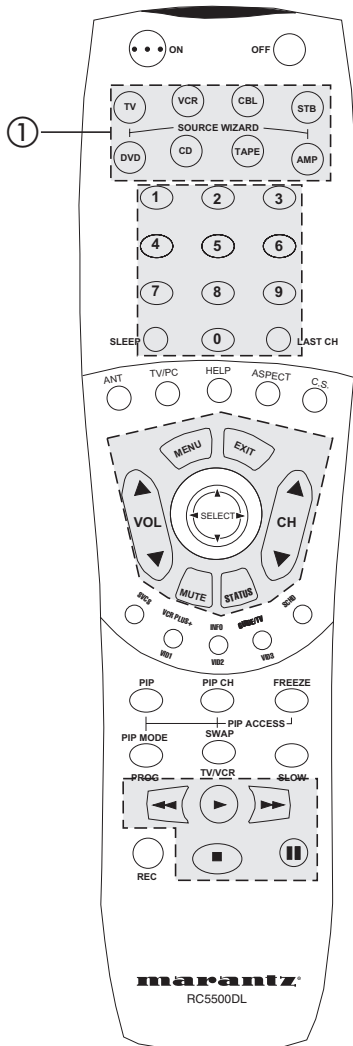

① These buttons allow the remote to control your TV, VCR, cable box, set-top-box/satellite receiver, DVD player, or other Audio/Video equipment depending on which mode is chosen, as explained above.

HOW TO USE THE REMOTE TO CONTROL YOUR TV

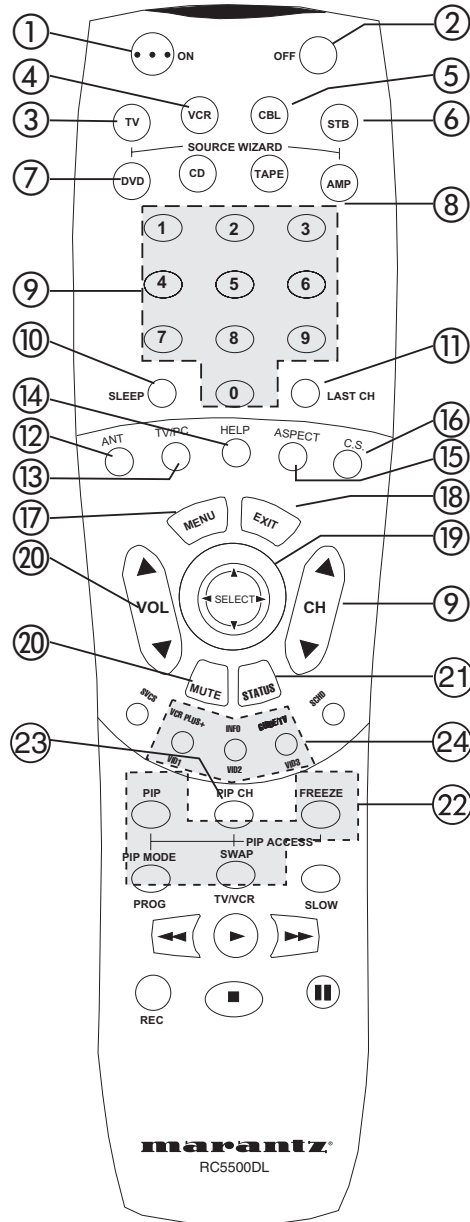

- ① **ON button**
Press this button to turn the TV set on when the remote is in TV mode.
- ② **OFF button**
Press this button to turn the TV set off when the remote is in TV mode.
- ③ **TV button**
When the TV button is pressed, it will blink, to indicate the remote is in TV mode.
- ④ **VCR button**
When the VCR button is pressed, it will blink to indicate the remote is in VCR mode. (see page 31)
- ⑤ **CABLE (CBL)**
When the CABLE button is pressed, it will blink to indicate the remote is in CABLE mode. (see page 32)
- ⑥ **SET-TOP-BOX (STB)**
When the STB button is pressed, it will blink to indicate the remote is in STB mode. If you have a satellite receiver, use this button to program your satellite receiver. (see page 33).
- ⑦ **DVD button**
When the DVD button is pressed, it will blink to indicate the remote is in DVD mode. (see page 34)



HOW TO USE THE REMOTE TO CONTROL YOUR TV

⑧ CD, TAPE, AMP buttons

When pressed, each of these buttons will blink to indicate the remote is in Audio/Video mode. (see page 35)

⑨ CHANNEL selector buttons

CHANNEL selector buttons are used to set FAMILY FAVORITES, CHANNEL MEMORY, etc.

Enter one, two, or three numbers to select channels. Enter "0" first for channels 1 to 9, or simply press the single digit channel you wish to tune then wait a few seconds for the TV to tune. For channels 100 and above, press the "1" button, wait until two dashes appear next to the channel display on your TV, then enter the remaining two numbers using the number buttons.

Channel selection may also be performed by pressing CH up (▲) or down (▼).

You can also use these number buttons to directly access OSD sub-menus of your choice. While navigating the On-Screen-Displays, you will notice that each sub-menu has a number next to it. For example, the SET UP menu has 9 sub-menus. Pressing the 7 button while in the SET UP menu will take you directly to the CLOCK SET sub-menu. This makes navigating the menus faster and easier.

NOTE: The TV may not receive some channels if you are not in the correct SIGNAL SOURCE mode. (see page 41)

⑩ SLEEP button

Press this button to display the sleep timer in the lower left corner of the screen. Every subsequent press of this button will add 15 minutes to this timer, up to a maximum of three hours. Once set, use RECALL when you want to view time remaining. If the SLEEP button is pressed while the timer is set, it will reset to the original condition.

⑪ LAST CHANNEL (LAST CH) button

Use this button to select between the last two channels viewed. (Good for watching two sporting events, etc.)

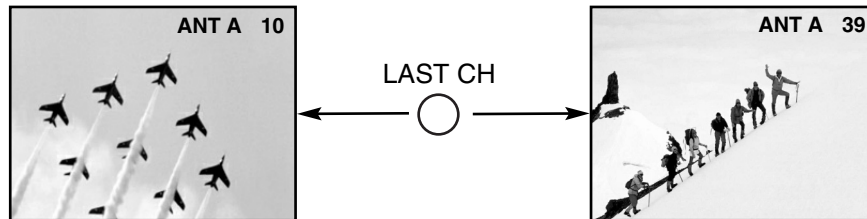

⑫ ANTENNA button

The ANT button will select between Antenna A and Antenna B each time the button is pressed.

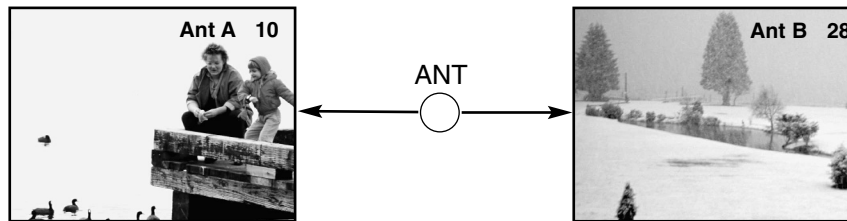

⑬ TV/PC button

Press this button to switch between TV, PC1 and PC2 modes.

⑭ HELP button

Press this button when a menu is displayed to view HELP text, which gives a description of the displayed menu. The HELP text will be displayed every time a MENU is displayed, until this button is pressed again.

⑮ ASPECT button

Press this button to quickly change the aspect ratio of the viewable picture in normal, full, fill, and smooth wide. (See page 46 and 47 for more information)

⑯ COMMERCIAL SKIP (C.S.) button

Press this button repeatedly to select channel skip time (30~180 seconds) when no menu is displayed and the TV will tune to the last channel viewed when the selected amount of time is up. The user can change stations, "SURF" to any station they wish, and after the selected amount of time, the TV will tune back to the original channel.

⑰ MENU button

The MENU button will start the On-Screen Display.

HOW TO USE THE REMOTE TO CONTROL YOUR TV



18 EXIT button
When in MENU mode, this button will exit all On-Screen Displays.

19 THUMB STICK/SELECT button
All the On-Screen Display features can be set or adjusted by using the THUMB STICK. The THUMB STICK will highlight functions or adjust and set different features. Press the THUMB STICK toward desired direction and press down to SELECT.

20 VOLUME, MUTE button
Press the VOLUME up (▲) or down (▼) button until you obtain the desired sound level.

To reduce the sound to one half of normal volume (SOFT MUTE) to answer the telephone, etc., press the MUTE button. Press the MUTE button again to turn the sound off completely (MUTE). To restore the sound, press the MUTE button one more time, or press the VOLUME Up (▲) button.



21 STATUS button
Press this button when no menu is displayed when you want to check the channel being received, the picture source, if the channel has stereo (ST) or second audio program (SAP), the time, CHANNEL ID, if the Commercial Skip (C.S.) function is activated and if the SLEEP timer is set.

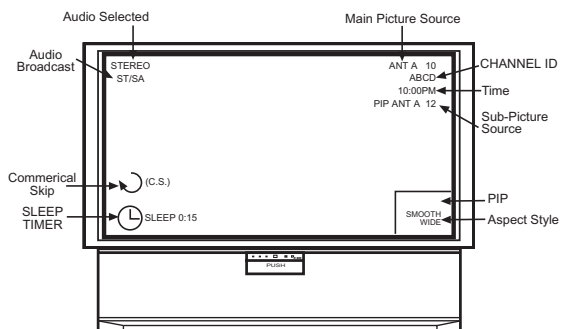

← When an S-VIDEO Input is connected.

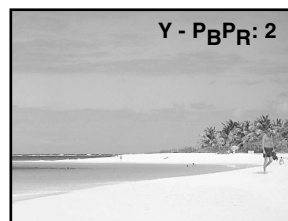

← When a COMPONENT VIDEO: Y-P_BPR Input is connected.

22 PICTURE-IN-PICTURE buttons
See separate section on page 28 for a description.

23 PIP CH button
Use the PIP CH button to select between main picture and sub-picture tuning. The channel number which is highlighted indicates what channel is being controlled.

24 VID1 ~ VID3
When the remote control is in TV mode, press these buttons to directly select the video input sources between the five video inputs. When the remote control is in Set-Top-Box mode (STB) these buttons will control the Set-Top-Box.

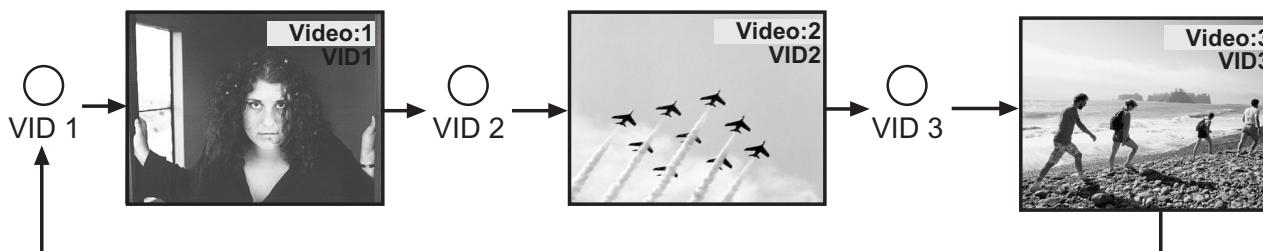



PICTURE-IN-PICTURE (PIP)

Your MARANTZ Projection TV incorporates Dual Tuner technology designed for improved viewing enjoyment. This Dual Tuner feature allows you to view antenna inputs on both the main picture and sub-picture simultaneously, with separate tuning control for each. The Dual Tuner can operate with only one input (ANT A only) or two inputs (ANT A and ANT B).

ANT A input can be viewed as both the main picture and the sub-picture simultaneously. ANT B can only be viewed as a main picture. (Component: Y-P_BP_R input can be viewed as sub-picture only when SPLIT PIP mode is selected.) To select between main picture and PIP sub-picture tuning, press the PIP CH button on the remote. The highlighted channel display will move with every press of the PIP CH button. When the top channel display is highlighted, channel tuning is for the main picture. When the lower channel display is highlighted, channel tuning is for the PIP sub-picture. This method of picture tuning is the same for one antenna input (ANT A only) and two antenna inputs (ANT A and ANT B).

The Picture-in-Picture feature is convenient when you want to watch more than one program at the same time. You can watch a TV program while viewing other programs from the ANT A source or any of the video inputs.

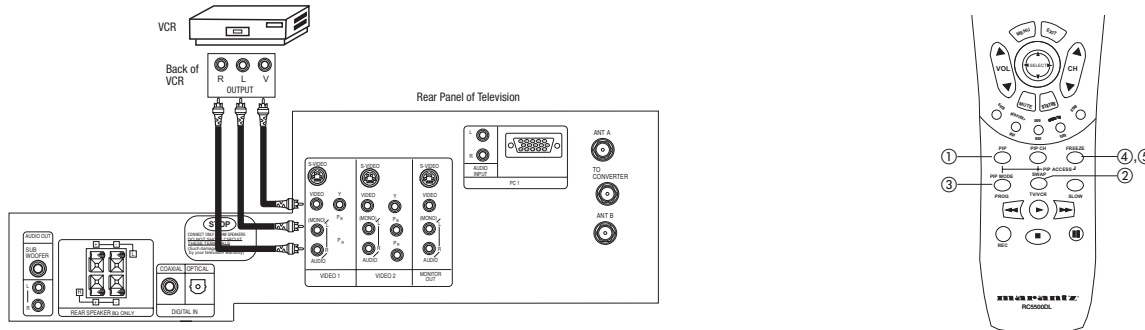

Use above connection to view VCR program as a sub-picture while viewing another program as a main picture (ANT A, ANT B, V:2 or V:3 input). You may also view the VCR program as a main picture while viewing another program as a sub-picture (ANT A, V:2 or V:3 input).

① PIP button

Press the PIP button and a sub-picture will appear in one of the three different modes (SINGLE, SPLIT or SURF), depending on the last selection of the PIP mode. To change the PIP mode, use the PIP MODE button to cycle through the three different modes.

SINGLE MODE PIP

Press the PIP button and a sub-picture appears in one corner of the screen. Press the PIP button again to remove the sub-picture from the screen. Use the PIP CH button to select between main and sub-picture tuning control (indicated by highlighted channel display.) Press the VID1-VID3 button when sub-picture channel tuning is being controlled, to change between VIDEO: 1, VIDEO: 2, VIDEO: 3. Press ANT button to change to ANT A source. (ANT B source cannot be viewed as a sub-picture.)

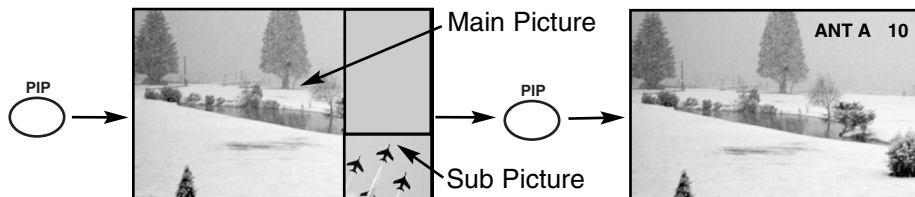

SPLIT MODE PIP

When you press the "PIP" button, the main channel and the PIP sub-picture will appear at the center of the screen (main channel on left side and sub-picture on right side). Press the "PIP" button a second time to return to normal viewing. Use the PIP CH button to select between main and sub-picture tuning control (indicated by highlighted channel display). Press the VID1-VID3 button when sub-picture channel tuning is being controlled, to change between VIDEO:1, VIDEO:2, VIDEO:3. Press ANT button to change to ANT A source. (ANT B source cannot be viewed as a sub-picture).

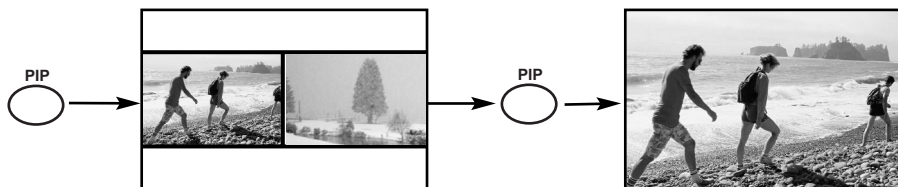

- NOTES:**
1. Y-P_BP_R input cannot be viewed as main picture or sub-picture when in SINGLE PIP MODE. If you tune to a Y-P_BP_R input, the TV set will automatically change to SPLIT PIP MODE.
 2. When ANT B is selected as the main channel, the SWAP feature is disabled.
 3. COMPONENT: Y-P_BP_R input can be viewed as main or sub-picture, only when SPLIT PIP MODE is chosen.
 4. Only sound from the main picture can be heard.
 5. It will take more than 3 seconds for the CPU to synchronize the motor frequency with input signal frequency when you change the VIDEO input mode (Video: 1, Video: 2 and so on), or press the TV/PC button to switch between TV, PC1 and PC2 modes.

PICTURE-IN-PICTURE (PIP)



PICTURE-IN-PICTURE CONT.

SURF MODE PIP

This feature will automatically scan all active channel numbers (those set in memory) and display them as PIP sub-pictures, along the right edge of the screen. Press the PIP button a second time to remove the sub-pictures from the screen.



- NOTES:**
1. If no buttons are pressed when in SURF mode, auto-scanning will continuously scan channels in memory. (see pages 42 and 43)
 2. If a channel is tuned during this SURF scanning, sub-pictures will be removed from the screen.
 3. SURF MODE PIP is allowed only when ANT A is selected as the main channel.
 4. If PARENTAL CONTROL MOVIE/TV RATINGS setting is ON, PIP SURF mode will be deactivated.

② SWAP button

If you wish to switch what is being shown on the main picture to the sub-picture, press the SWAP button.

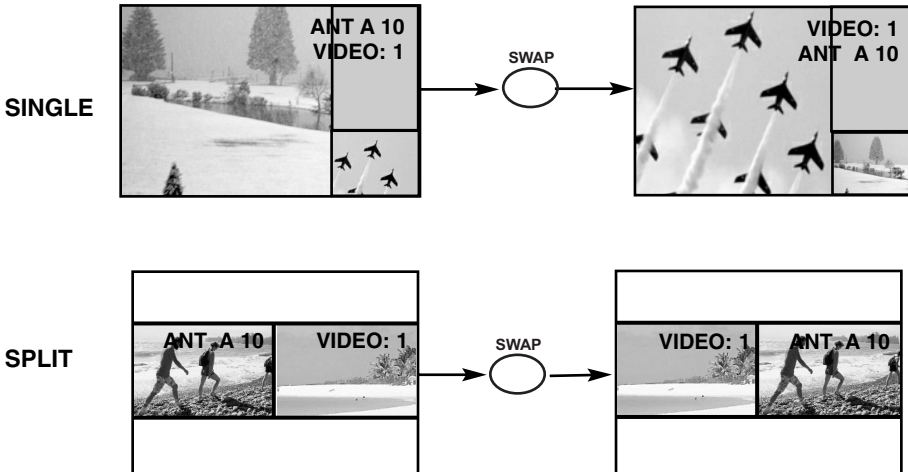

- NOTES:**
1. The SWAP button will only operate when SINGLE PIP mode or SPLIT PIP mode is chosen.
 2. The SWAP function will not operate if ANT B input is set as the main channel (ANT B input cannot be displayed as a sub-picture.)

③ PIP MODE button

To change between the three different PIP modes (SINGLE, SPLIT, or SURF) press the PIP MODE button when PIP is ON. Each press of this button will change PIP to a different mode. Pressing this button three times will cycle through all three different PIP modes.

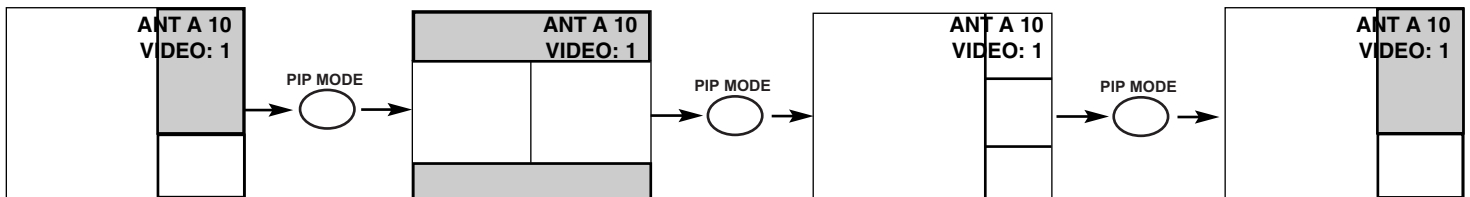

- NOTES:**
1. When main channel is COMPONENT: Y-P_BP_R input, only SPLIT PIP mode will be allowed. If sub-picture is changed to a COMPONENT: Y-P_BP_R using the PIP CH button, the PIP mode will automatically change to SPLIT mode.
 2. SURF mode PIP is only allowed when ANT A is the main picture.



PICTURE-IN-PICTURE (PIP)

④ FREEZE button (With PIP ON)

If you wish to freeze the sub-picture, press the FREEZE button. This is convenient when trying to write down the address for a mail order company, recording statistics for a sporting event, etc. To return the picture to motion, press the FREEZE button again.

NOTE: The FREEZE function will only operate when SINGLE PIP or SPLIT PIP mode is chosen.

⑤ FREEZE button (With PIP OFF)

Press the FREEZE button to freeze the picture, depending on the mode selected (SINGLE, SPLIT or STROBE). To change FREEZE modes, use the PIP MODE button to cycle through the three different modes.

SINGLE FREEZE

Press the FREEZE button to freeze one frame of the picture you are currently viewing. Press this button again or PIP to return to normal viewing.

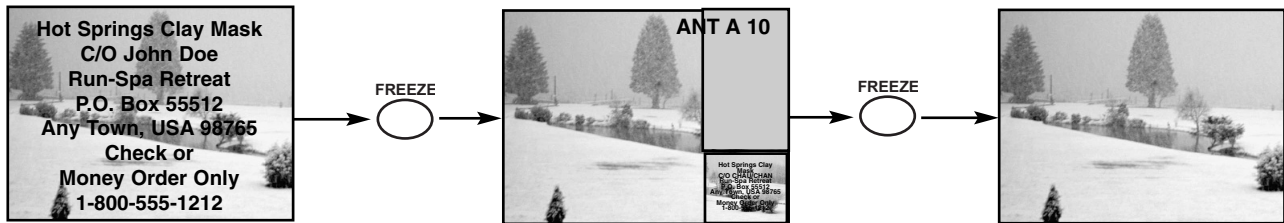

SPLIT FREEZE

Press the FREEZE button to freeze the picture you are currently viewing. (Only the right sub-picture will freeze). Press this button again or PIP to return to normal viewing.

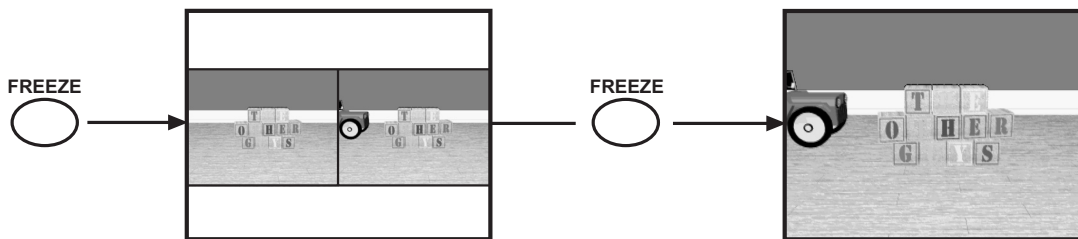

STROBE FREEZE

Press the FREEZE button to freeze three frames of the picture you are currently viewing. Press this button again or PIP to return to normal viewing. This feature is useful for viewing a moving picture that has many details, for example, a close play in a sporting

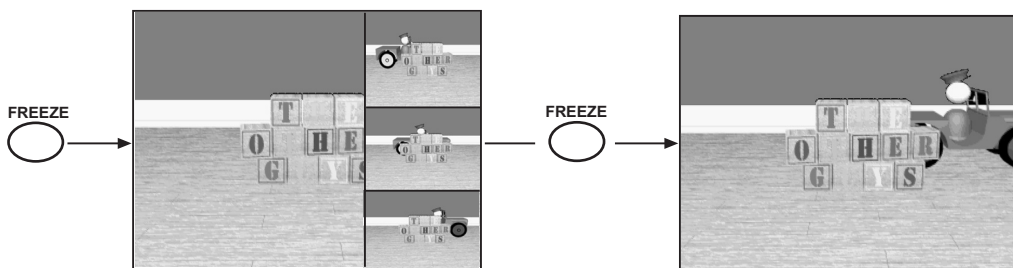

 **CAUTION:** A pattern burn may develop if the sub-picture is left in the same corner permanently. If the PIP feature is used frequently, occasionally MOVE the sub-picture using the THUMB STICK ▲, or ▼.

NOTES: 1. Each freeze frame is delayed about 0.1 (1/10) second.
2. When viewing a COMPONENT: Y-P_BP_R VIDEO input, only SPLIT MODE FREEZE is allowed.

USING THE REMOTE TO CONTROL VCR FUNCTION



Operating the precoded function for your VCR.

This remote is designed to operate different types of VCRs. You must first program the remote to match the remote system of your VCR. (refer to page 36 for pre-codes)

1. Turn ON your VCR.
2. Aim the remote control at the front of your VCR.
3. Press and release the VCR button to switch to VCR pre-coded mode.
4. Hold down the VCR button on the remote and enter the two digit preset code that matches your VCR, as shown on page 36. The indicator light will flash 3 times if the code was accepted.
5. Aim the remote at the VCR and press the OFF button. The remote will turn off your VCR when the correct two digit preset code is entered. When this occurs, the remote control is programmed for your VCR. If the VCR does not turn off, try a different two digit preset code.
6. The remote will now control your VCR.

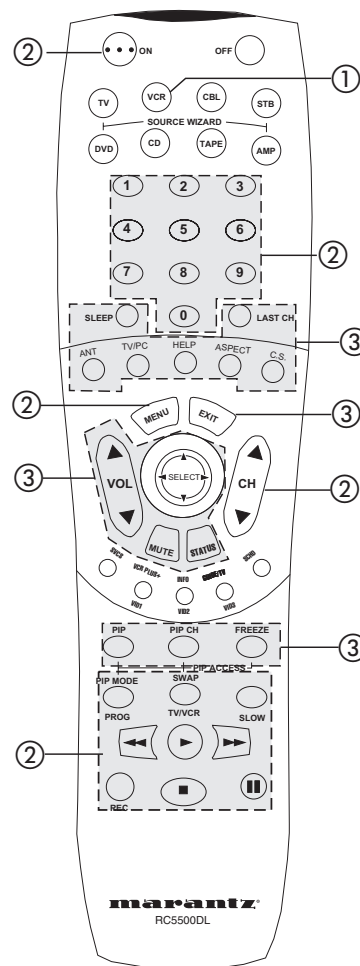

NOTES:

1. If your VCR cannot be operated after performing the above procedures, your VCR's code has not been precoded into the remote.
2. In the unlikely event that your VCR cannot be operated after performing the above procedures, please consult your VCR operating guide.
3. The remote control will remember the codes you have programmed until the batteries are removed from the remote control. After replacing the batteries repeat the entire programming procedure as stated above.
4. The LAST CH button will act as your VCR ENTER button if required.
5. The SLEEP button will act as your VCR '100' button if required.

- ① **VCR Button**
This button allows the remote to control your VCR by setting it to VCR mode.
- ② **PRECODED VCR Buttons**
These buttons transmit the chosen precoded VCR codes. For some VCRs, you must press the RECORD button twice to record a program.
- ③ **EXCLUSIVE TV Buttons**
These buttons are for operating the TV.

MY VCR CODE IS: _____

NOTE: Refer to instruction manual of the VCR for operation of the buttons exclusively for the VCR.



USING THE REMOTE TO CONTROL CABLE BOX FUNCTIONS

Operating the precoded function for your cable box.

This remote is designed to operate different types of cable boxes. You must first program the remote to match the remote system of your cable box. (refer to page 36)

1. Turn ON your cable box.
2. Aim the remote control at the front of your cable box.
3. Press and release the Cable (CBL) button to switch to Cable pre-coded mode.
4. Hold down the CBL button on the remote and enter the two digit preset code that matches your cable box as shown on page 36. The indicator light will flash 3 times if the code was accepted.
5. Aim the remote at the cable box and press the OFF button. The remote will turn off your cable box when the correct two digit preset code is entered. When this occurs, the remote control is programmed for your cable box. If the cable box does not turn off, try a different two digit preset code.
6. The remote will now control your Cable box.

NOTES:

1. If your cable box cannot be operated after performing the above procedures, your cable box code has not been precoded into the remote.
2. In the unlikely event that your cable box cannot be operated after performing the above procedures, please consult your cable box operating guide.
3. The remote control will remember the codes you have programmed until the batteries are removed from the remote control. After replacing the batteries repeat the entire programming procedure as stated above.
4. The LAST CH button will act as the cable box ENTER button if required.
5. The SLEEP button will act as your cable box '100' button if required.
6. The ANT button will act as the TV/STB button when in STB mode.

- ① **CABLE (CBL) button**
This button allows the remote to control your cable box by setting it to CABLE mode.
- ② **PRECODED CABLE BOX buttons**
These buttons transmit the chosen precoded cable codes.
- ③ **EXCLUSIVE TV buttons**
These buttons are for operating the TV.

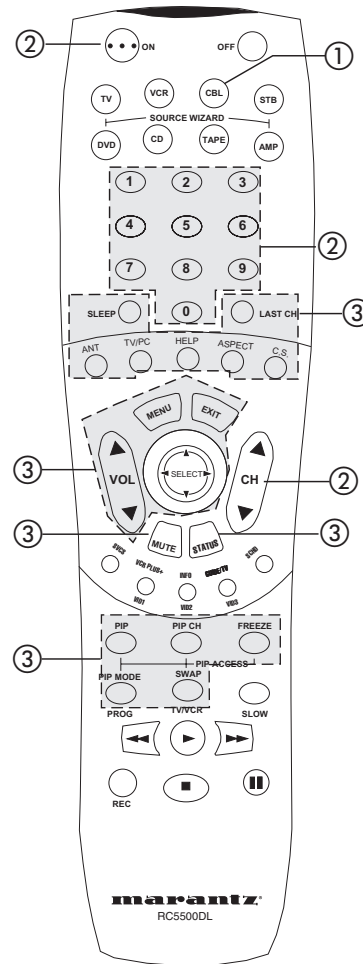

MY CABLE BOX CODE IS: _____

NOTE: Refer to instruction manual of the Cable Box for operation of the buttons exclusively for the Cable Box.

USING THE REMOTE TO CONTROL SET-TOP-BOX/SATELLITE RECEIVER FUNCTIONS



Operating the precoded function for your satellite receiver.

This remote is designed to operate different types of set-top-box/satellite systems. You must first program the remote to match the remote system of your set-top-box/satellite receiver. (refer to page 36)

1. Turn ON your set-top-box/satellite receiver.
2. Aim the remote control at the front of your set-top-box/satellite receiver.
3. Press and release the SET-TOP-BOX (STB) button to switch to set-top-box/satellite pre-coded mode.
4. Hold down the STB button on the remote and enter the two digit preset code that matches your set-top-box/satellite receiver as shown on page 36. The indicator light will flash 3 times if the code was accepted.
5. Aim the remote at the set-top-box/satellite receiver and press the OFF button. The remote will turn off your set-top-box/satellite receiver when the correct two digit preset code is entered. When this occurs, the remote control is programmed for your set-top-box/satellite receiver. If the set-top-box/satellite receiver does not turn off, try a different two digit preset code.
6. The remote will now control your set-top-box/satellite receiver.

NOTES:

1. If your set-top-box/satellite receiver cannot be operated after performing the above procedures, your set-top-box/satellite receiver code has not been precoded into the remote.
2. In the unlikely event that your set-top-box/satellite receiver cannot be operated after performing the above procedures, please consult your set-top-box/satellite receiver operating guide.
3. The remote control will remember the codes you have programmed until the batteries are removed from the remote control. After replacing the batteries repeat the entire programming procedure as stated above.
4. The ANT button will act as the TV/STB button when in STB mode.

- ① **SET-TOP-BOX (STB) button**
This button allows the remote to control your set-top-box/satellite receiver by setting it to SET-TOP-BOX/SATELLITE mode.
- ② **PRECODED SET-TOP-BOX/SATELLITE RECEIVER buttons**
These buttons transmit the chosen precoded satellite codes.
- ③ **EXCLUSIVE TV buttons**
These buttons are for operating the TV.

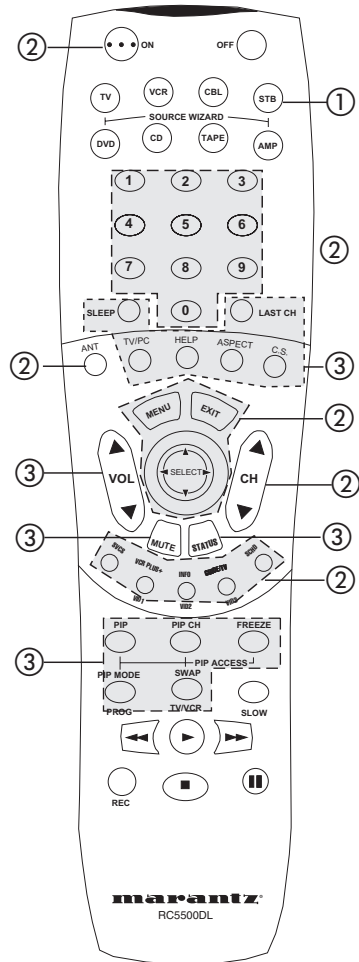

**MY SET-TOP-BOX/
SATELLITE CODE IS: _____**

NOTE: Refer to instruction manual of the Set-Top-Box/Satellite Receiver for operation of the buttons exclusively for the Set-Top-Box/Satellite Receiver.



USING THE REMOTE TO CONTROL DVD FUNCTIONS

Operating the precoded function for your DVD player.

This remote is designed to operate different types of DVD players. You must first program the remote to match the remote system of your DVD player. (refer to page 36 for pre-codes)

1. Turn ON your DVD player.
2. Aim the remote control at the front of your DVD player.
3. Press and release the DVD button to switch to DVD pre-coded mode.
4. Hold down the DVD button on the remote and enter the two digit preset code that matches your DVD player, as shown on page 36. The indicator light will flash 3 times if the code was accepted.
5. Aim the remote at the DVD player and press the OFF button. The remote will turn off your DVD player when the correct two digit preset code is entered. When this occurs, the remote control is programmed for your DVD player. If the DVD player does not turn off, try a different two digit preset code.
6. The remote will now control your DVD player.

NOTES:

1. If your DVD player cannot be operated after performing the above procedures, your DVD player's code has not been precoded into the remote.
2. In the unlikely event that your DVD player cannot be operated after performing the above procedures, please consult your DVD player operating guide.
3. The remote control will remember the codes you have programmed until the batteries are removed from the remote control. After replacing the batteries repeat the entire programming procedure as stated above.

① DVD Button

This button allows the remote to control your DVD player by setting it to DVD mode.

② PRECODED DVD Buttons

These buttons transmit the chosen precoded DVD codes.

③ EXCLUSIVE TV Buttons

These buttons are for operating the TV.

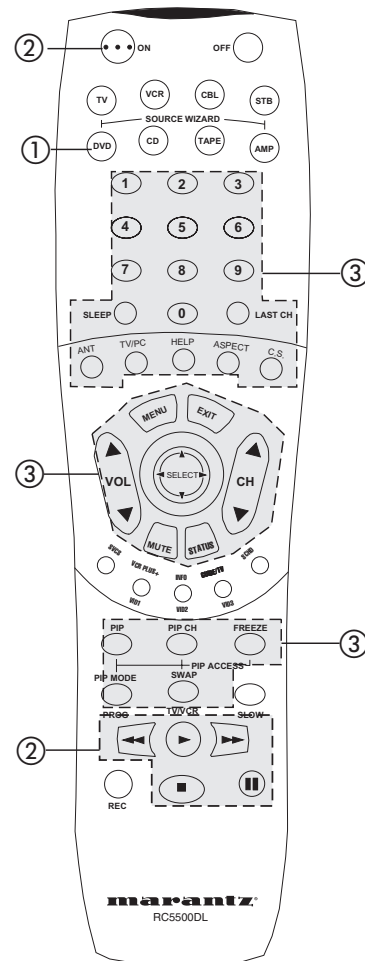

MY DVD PLAYER CODE IS: _____

NOTE: Refer to instruction manual of the DVD player for operation of the buttons exclusively for the DVD player.

USING THE REMOTE TO CONTROL ADDITIONAL AUDIO/VIDEO EQUIPMENT



Operating the precoded function for your Audio/Video component.

This remote is designed to operate different types of Audio/Video component. You must first program the remote to match the remote system of your Audio/Video component. (refer to page 36 for pre-codes)

1. Turn ON your Audio/Video component you wish to control with the Remote.
2. Aim the remote control at the front of your Audio/Video component.
3. Press and release the CD, TAPE or AMP button to switch to Audio/Video component pre-coded mode.
4. Hold down the CD, TAPE or AMP button on the remote and enter the two digit preset code that matches your Audio/Video component, as shown on page 36. The indicator light will flash 3 times if the code was accepted.
5. Aim the remote at the Audio/Video component and press the OFF button. The remote will turn off your Audio/Video component when the correct two digit preset code is entered. When this occurs, the remote control is programmed for your Audio/Video component. If the Audio/Video component does not turn off, try a different two digit preset code.
6. The remote will now control your Audio/Video component.
7. Repeat steps 1 - 6 if you wish to program the remote to control another Audio/Video component.

NOTES:

1. If your Audio/Video component cannot be operated after performing the above procedures, your Audio/Video component's code has not been precoded into the remote.
2. In the unlikely event that your Audio/Video component cannot be operated after performing the above procedures, please consult your Audio/Video equipment operating guide.
3. The remote control will remember the codes you have programmed until the batteries are removed from the remote control. After replacing the batteries repeat the entire programming procedure as stated above.

① CD, TAPE or AMP Buttons

These buttons allow the remote to control your Audio/Video equipment by setting it to Audio/Video mode.

② PRECODED AUDIO/VIDEO Buttons

These buttons transmit the chosen precoded Audio/Video component codes.

③ EXCLUSIVE TV Buttons

These buttons are for operating the TV.

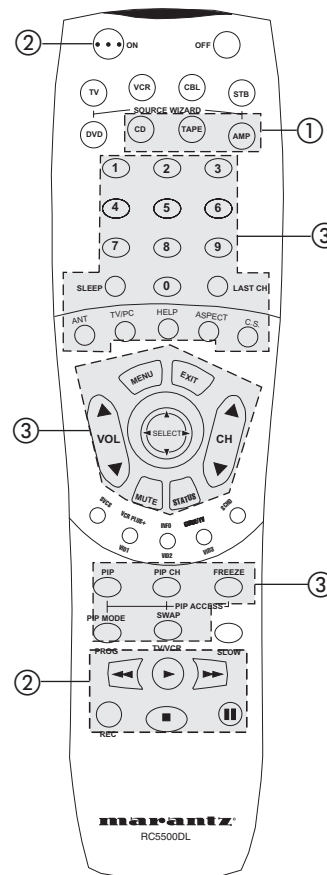

MY AUDIO/VIDEO EQUIPMENT CODE IS:

CD _____
 TAPE _____
 AMP _____

NOTE: Refer to instruction manual of the Audio/Video equipment for operation of the buttons exclusively for the Audio/Video equipment.



VCR, CABLE, SATELLITE, DVD and AUDIO/VIDEO CODES

VCR BRAND	CODE	Pioneer.....	26	Contec.....	21	AMPLIFIER BRAND	CODE
Adventura.....	01	Protec.....	30	Dae Ryung.....	20	Aiwa.....	05, 06
Aiko.....	09	Pulsar.....	15	Eastern.....	14	Carver.....	01, 06, 08
Aiwa.....	01	Quarter.....	18	Electricord.....	31	Denon.....	10
Akai.....	02, 47, 48	Quartz.....	18	Everquest.....	51	Fisher.....	08, 11
American High.....	23	Quasar.....	23	Focus.....	52	Hitachi.....	12
Asha.....	44	RCA.....	03, 04, 05, 35, 40, 46	Garrard.....	11	JVC.....	13
Audiovox.....	24	Radix.....	24	GC Electronics.....	32, 39	Kenwood.....	14, 15, 17, 18
Beaumarck.....	44	Randex.....	24	Gemini.....	05, 38, 43, 51	Magnavox.....	01, 06
Bell & Howell.....	32	RCA.....	03, 04, 05, 35, 40, 46	General Instrument.....	01, 12	Marantz.....	01, 06, 16
Broksonic.....	33, 34, 41	Realistic.....	01, 18, 19, 20, 21, 23, 24, 32, 44	Goldstar.....	10, 25	MCS.....	16
Calix.....	24	Ricoh.....	22	Hamlin.....	04, 13, 22, 23	Optimus.....	03, 04, 11, 15, 20
Canon.....	23	Runco.....	15	Hitachi.....	01	Panasonic.....	16
Carver.....	31	Samsung.....	17, 44	Hytex.....	36	Philips.....	01, 06
CCE.....	09, 30	Sanky.....	15, 20	Jasco.....	11	Pioneer.....	03, 04, 20, 21, 22
Citizen.....	09, 24	Sansui.....	02, 26	Jerrold.....	01, 08, 12, 37, 49, 50, 51	Quasar.....	16
Colt.....	30	Sanyo.....	18, 19, 32, 44	Macom.....	35	Sansui.....	06
Craig.....	19, 24, 30, 44	Scott.....	16, 17, 33, 34, 36, 41	Magnavox.....	15	Sanyo.....	11
Curtis Mathes.....	02, 23, 46	Sears.....	03, 05, 18, 19, 21, 23, 24, 32	Memorex.....	03	Sharp.....	15
Cybermex.....	44	Sharp.....	20	Movie Time.....	29, 31, 33	Sony.....	05
Daewoo.....	09, 17	Shintom.....	30	NSC.....	29, 33, 38	Technics.....	02, 16, 23, 24, 25
Dynatech.....	01	Shogun.....	44	Oak.....	21, 36, 46	Victor.....	13
Electroponic.....	24	Singer.....	30	Panasonic.....	02, 03, 09	Wards.....	03, 05, 06, 08, 20, 21
Emerex.....	08	Sony.....	08, 10, 22, 23	Paragon.....	03	Yamaha.....	15, 26
Emerson.....	01, 09, 13, 16, 24, 27, 28, 33, 34, 36, 41, 47	STS.....	03	Phillips.....	11, 15, 16, 26, 30, 42, 43, 44		
Fisher.....	19, 21, 32	Sylvania.....	01, 16, 23, 31	Pioneer.....	06, 10, 19	CD BRAND	CODE
Fuji.....	10, 23	Symphonic.....	01	Popular Mechanics.....	52	Adcom.....	01
Funai.....	01	Tatung.....	02	Pulsar.....	03	Aiwa.....	02
Garrard.....	01	Teac.....	01, 02	RCA.....	02	California Audio Lab.....	03
GE.....	04, 23, 40, 46	Technics.....	23, 38	Realistic.....	39	Carver.....	02
Goldstar.....	24, 25, 43	Teknika.....	01, 23, 24	Recoton.....	52	Denon.....	04
Gradiente.....	01	TMK.....	27, 44	Regal.....	04, 22, 34	DKK.....	05
Harley Davidson.....	01	Toshiba.....	16, 17, 21, 36	Regency.....	14	Emerson.....	01
Harmon/Kardon.....	25	Totvision.....	24, 44	Rembrandt.....	01, 38	Fisher.....	06
Harwood.....	30	Unitech.....	44	Runco.....	03	Genexxa.....	07
Headquarter.....	18	Vector.....	17	Samsung.....	10, 25	Hitachi.....	01, 07, 08, 09, 10, 11, 12
Hi-Q.....	19	Vector Research.....	25	Scientific Atlanta.....	17, 20, 41, 45	JVC.....	13
Hitachi.....	01, 02, 03, 04, 05	Video Concepts.....	17, 47	Signal.....	25, 51	Kenwood.....	06, 14, 15
Jensen.....	02	Videosonic.....	44	Signature.....	01	Krell.....	02
JVC.....	02, 14, 26	Wards.....	01, 03, 19, 20, 23, 30, 35, 36, 44, 46	SL Marx.....	25	Magnavox.....	02
KEC.....	09, 24	XR-1000.....	01, 23, 30	Sprucer.....	02	Marantz.....	02, 03
Kenwood.....	02, 25, 26	Yamaha.....	10, 15, 22	Starcom.....	37, 49, 51	MCS.....	03
KLH.....	30			Stargate.....	25, 51	Mission.....	03
Kodak.....	23, 24	DVD BRAND	CODE	Starquest.....	51	NSM.....	02
Lloyd.....	01	Denon.....	04	Starsight.....	53, 54	Onkyo.....	16
Lloyd's.....	27	Hitachi.....	07, 12	Sylvania.....	18	Optimus.....	05, 07, 17
Logik.....	30	JVC.....	01	Television.....	25	Panasonic.....	03
LXI.....	24	Kenwood.....	04	Texscan.....	18	Philips.....	02
Magnavox.....	15, 23, 31, 35	Magnavox.....	05	Tocom.....	07, 27, 50	Pioneer.....	07, 17
Magnin.....	44	Mitsubishi.....	10	Toshiba.....	03	Proton.....	02
Marantz.....	23, 31	Panasonic.....	04	Tusa.....	51	QED.....	02
Marta.....	24	Phillips.....	06	TV 86.....	29	Quasar.....	03
Matsushita.....	23	Pioneer.....	03	Unika.....	11, 39	RCA.....	01, 21
MEI.....	23	RCA (Proscan).....	09	United Artists.....	36	Realistic.....	01
Memorex.....	01, 15, 18, 19, 20, 23, 24, 32, 44	Samsung.....	12	United Cable.....	49	Rotel.....	02
MGA.....	16, 47	Sony.....	02	Universal.....	11, 24, 31, 32, 34, 39	SAE.....	02
MGN Technology.....	44	Toshiba.....	05	Videoway.....	47	Sansui.....	02
Minolta.....	03, 05	Yamaha.....	08	Viewstar.....	15, 28, 29, 40	Scott.....	01
Mitsubishi.....	16, 26, 39, 47, 48	Zenith.....	05, 11	Zenith.....	03, 48	Sony.....	05, 18
Motorola.....	20, 23			Zentek.....	52	Technics.....	03, 19, 20
MTC.....	01, 44	CABLE BRAND	CODE			Victor.....	13
Multitech.....	01, 30	ABC.....	01, 07, 08, 17, 18, 20, 36, 37, 49	SATELLITE BRAND	CODE		
NEC.....	02, 25, 26, 32	Antronix.....	39	Echostar.....	04	TAPE BRAND	CODE
Nikko.....	24	Archer.....	11, 24, 39	Hitachi.....	01	Aiwa.....	11, 12
Noblex.....	44	Belcor.....	32	Hughes.....	05	Hitachi.....	01, 02, 03, 04
Olympus.....	12, 23	Cable Star.....	32	RCA.....	02	JVC.....	05
Optimus.....	20, 24, 32	Century.....	11	Sony.....	03	Kenwood.....	06
Panasonic.....	11, 12, 23, 38	Citizen.....	11			Optimus.....	07
Penney.....	03, 23, 24, 25, 44	Colour Voice.....	30, 42	SET-TOP-BOX	CODE	Pioneer.....	07
Pentax.....	03, 04, 05	Comtronics.....	25, 28	Panasonic.....	06	Sony.....	09, 10, 11, 12
Philco.....	23			RCA.....	07	Wards.....	07
Phillips.....	23, 31			Samsung.....	08		
Pilot.....	24						

ON SCREEN DISPLAY



1. Press MENU on the remote control to display the different features on your MARANTZ Projection TV.
2. Press the THUMB STICK to highlight a different feature.
3. Press EXIT on the remote control to quickly exit from a menu.
4. Press HELP on the remote control when a menu is displayed, and text will appear giving a description of that menu.

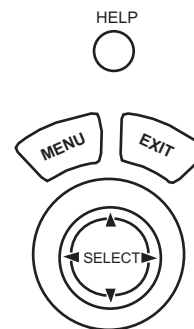

This part of the screen shows what selections are available.

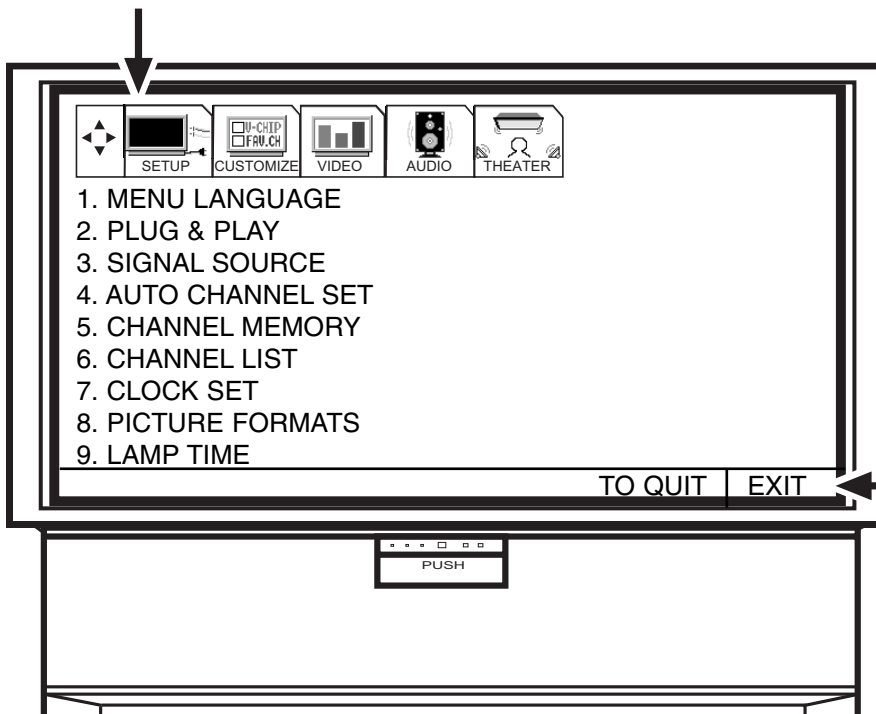

This part of the screen shows which remote control buttons to use.

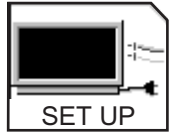

- | |
|---------------------|
| 1. MENU LANGUAGE |
| 2. PLUG & PLAY |
| 3. SIGNAL SOURCE |
| 4. AUTO CHANNEL SET |
| 5. CHANNEL MEMORY |
| 6. CHANNEL LIST |
| 7. CLOCK SET |
| 8. PICTURE FORMATS |
| 9. LAMP TIME |

Choose English, French, or Spanish text.
 Optimum hook up for your system.
 Select Antenna or Cable TV.
 First time set up for channel buttons.
 Channel buttons, add or skip.
 Check channel name, scan, and child lock.
 Set before using timer features.
 Select type of screen format and component input.
 Count the hours the television has operated.

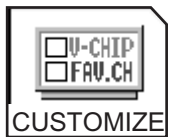

- | |
|---------------------|
| 1. CHANNEL ID. |
| 2. VIDEO ID. |
| 3. FAMILY FAVORITES |
| 4. PARENTAL CONTROL |
| 5. 4 EVENT PROGRAM |
| 6. AUTO LINK |
| 7. CLOSED CAPTION |
| 8. MENU BACKGROUND |

Label channels PAY1, ABC, etc.
 Label video inputs VCR1, DVD1, etc.
 Allow you to set and view favorite channels.
 Block channel picture and sound.
 Turn TV on and off once, daily, or weekly.
 Automatically turn TV on with any VIDEO input.
 Feature to display dialogue/text.
 Select from three types of backgrounds.



- | |
|----------------------|
| 1. CONTRAST |
| 2. BRIGHTNESS |
| 3. COLOR |
| 4. TINT |
| 5. SHARPNESS |
| 6. RESET |
| 7. ADVANCED SETTINGS |

Adjust contrast.
 Adjust brightness.
 Adjust color.
 Adjust tint.
 Adjust sharpness.
 Set VIDEO settings to factory preset.
 Improve picture performance.



- | |
|----------------------|
| 1. EQUALIZER |
| 2. RESET |
| 3. ADVANCED SETTINGS |

Precise audio control.
 Set AUDIO settings to factory preset.
 Improve sound performance.



- | |
|-----------------------|
| 1. THEATER MODES |
| 2. SURROUND |
| 3. INPUT SOURCE |
| 4. LISTENING POSITION |
| 5. LISTENING MODE |
| 6. SPEAKER SETUP |

Picture and sound are automatically set.
 Special sound effects, including Dolby Digital.
 Set audio of VIDEO 1 or VIDEO 2 to analog, optical or coaxial (digital).
 Set for optimum audio performance based on your listening position.
 Choose between Standard, Night, or Maximum.
 Select specific speaker output.

SET UP

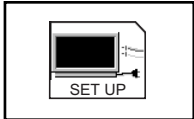

Select SETUP when setting your TV up for the first time. Use the THUMB STICK ▲ or ▼ on the remote to highlight the function desired.

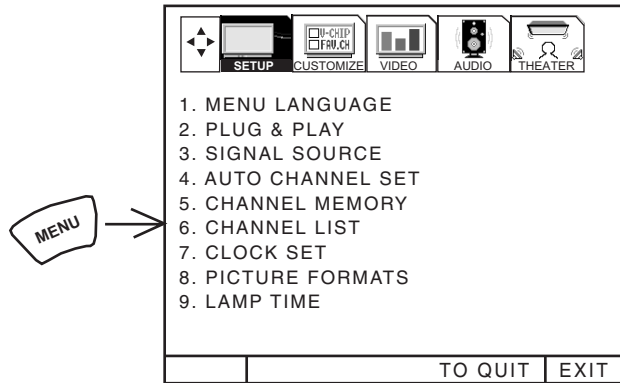

Use THUMB STICK ▲ or ▼ to select the sub-menu of your choice. You can also use the number buttons to directly access the sub-menu of your choice. For example, pressing the 7 button while in the OSD shown above, will take you directly to the CLOCK SET sub-menu.

MENU LANGUAGE

This feature will allow you to select any one of three different languages for all on-screen displays.

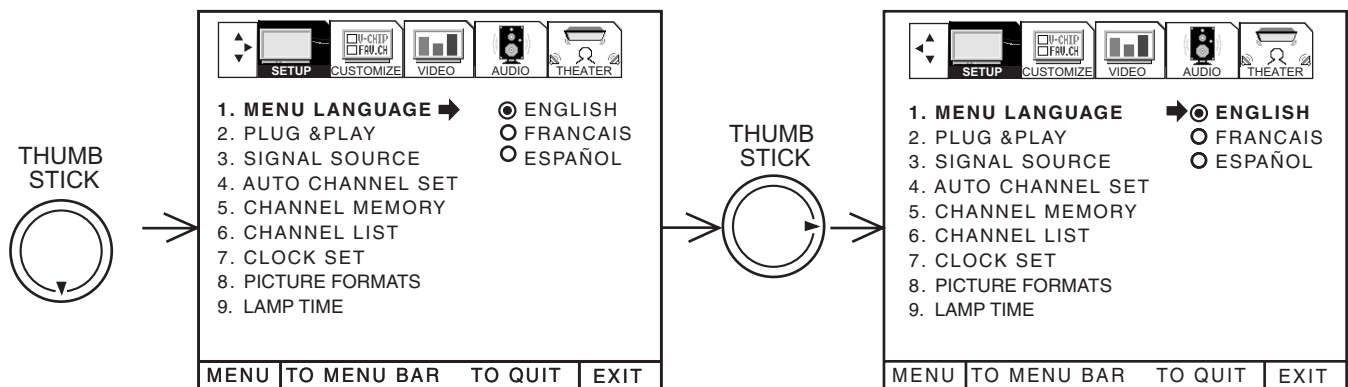

Use THUMB STICK ▲ or ▼ to select the MENU LANGUAGE of your choice.

Press EXIT to quit menu or THUMB STICK ◀ to return to previous menu.



PLUG & PLAY

This graphic guide function will help you to properly set up your TV or Home Theater System. Simply answer three questions and a graphic will be displayed, showing you the optimum setup for your personalized system.

SETUP	CUSTOMIZE	VIDEO	AUDIO	THEATER
1. MENU LANGUAGE				
2. PLUG & PLAY ▶				
3. SIGNAL SOURCE				
4. AUTO CHANNEL SET				
5. CHANNEL MEMORY				
6. CHANNEL LIST				
7. CLOCK SET				
8. PICTURE FORMATS				
9. LAMP TIME				
MENU	TO MENU BAR	TO QUIT	EXIT	

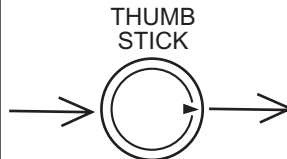

WELCOME TO YOUR PLUG & PLAY ON SCREEN SET UP GUIDE. AFTER ANSWERING THREE SIMPLE QUESTIONS, THIS SYSTEM WILL SHOW YOU TYPICAL CONNECTIONS FOR YOUR TV, CABLE, VCR, DVD, SET TOP BOX, OR SATELLITE RECEIVER. (FOR DETAILED CONNECTIONS REFER TO OWNERS GUIDE) PRESS ▶ TO START

MENU	TO MENU BAR	TO QUIT	EXIT
------	-------------	---------	------



QUESTION 1. MY TV SIGNAL COMES FROM:

A) **ANTENNA OR CABLE (WITHOUT CABLE BOX)**
 B) CABLE BOX
 C) SATELLITE RECEIVER
 D) SATELLITE RECEIVER (WITH CABLE BOX)

PRESS ▲, ▼ TO SELECT
 PRESS ▶ TO ENTER

MENU	TO MENU BAR	TO QUIT	EXIT
------	-------------	---------	------

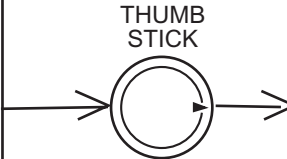

QUESTION 2. I WANT TO CONNECT A VCR/DVD TO MY SYSTEM.

A) **YES**
 B) NO

PRESS ▲, ▼ TO SELECT
 PRESS ▶ TO ENTER

MENU	TO MENU BAR	TO QUIT	EXIT
------	-------------	---------	------



QUESTION 3. I WANT TO CONNECT A SET TOP BOX TO MY SYSTEM

A) **YES**
 B) NO

PRESS ▲, ▼ TO SELECT
 PRESS ▶ TO ENTER

MENU	TO MENU BAR	TO QUIT	EXIT
------	-------------	---------	------

Press THUMB STICK ▲ or ▼ to highlight the correct answers to all three questions.
Press THUMB STICK ▶ to display the graphic guide.
Press EXIT to quit menu or THUMB STICK ▶ to begin AUTO CHANNEL SET. (see page 42)



SIGNAL SOURCE

Select ANTENNA if you are using an indoor or outdoor antenna. Select CATV if you have cable TV.

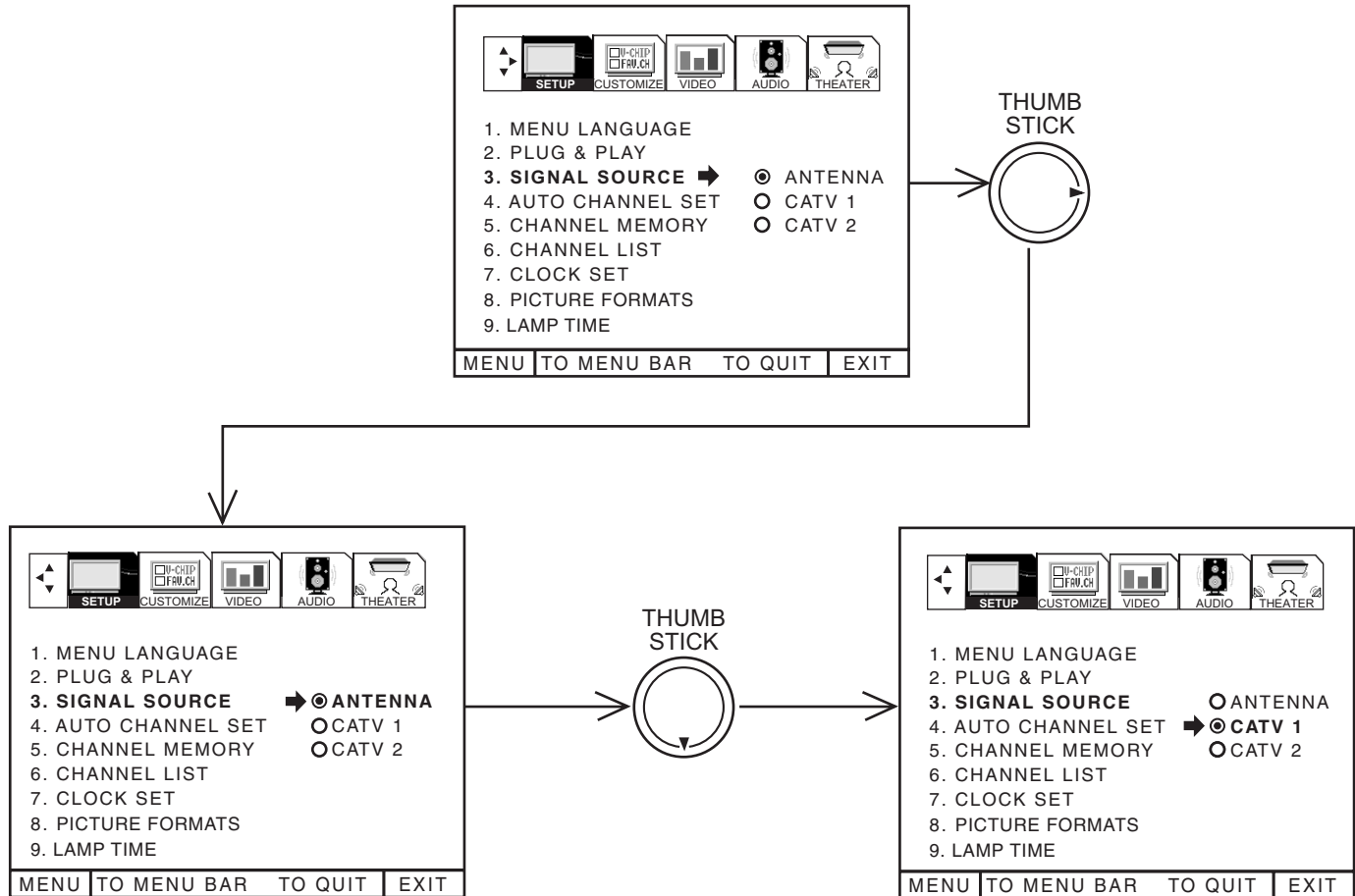

Press THUMB STICK ▲ or ▼ to highlight and select the correct SIGNAL SOURCE mode.
Press EXIT to quit MENU or THUMB STICK ◀ to return to previous menu.

RECEPTION BAND		
AIR	CATV 1 OR CATV 2	
	CATV CHANNEL	Indicated on the screen
VHF 2 ~ 13ch UHF 14 ~ 69ch	VHF 2~13	2 ~ 13
	Mid band A~1	14 ~ 22
	A-5 ~ A-1	95 ~ 99
	Super band J~W	23 ~ 36
	Hyper band W + 1 ~ W + 28	37 ~ 64
	Ultraband W + 29 ~ W + 84	65 ~ 125

Reception channels for each mode are shown at the left.

Refer to your cable or TV guide for channel identification standards.

If certain CATV channels are poor or not possible in CATV1 mode, set SIGNAL SOURCE to CATV2.

AUTO CHANNEL SET

This feature will automatically store active TV channels in CHANNEL MEMORY. This will allow you to skip unused channels when using CHANNEL UP (▲) or DOWN (▼).

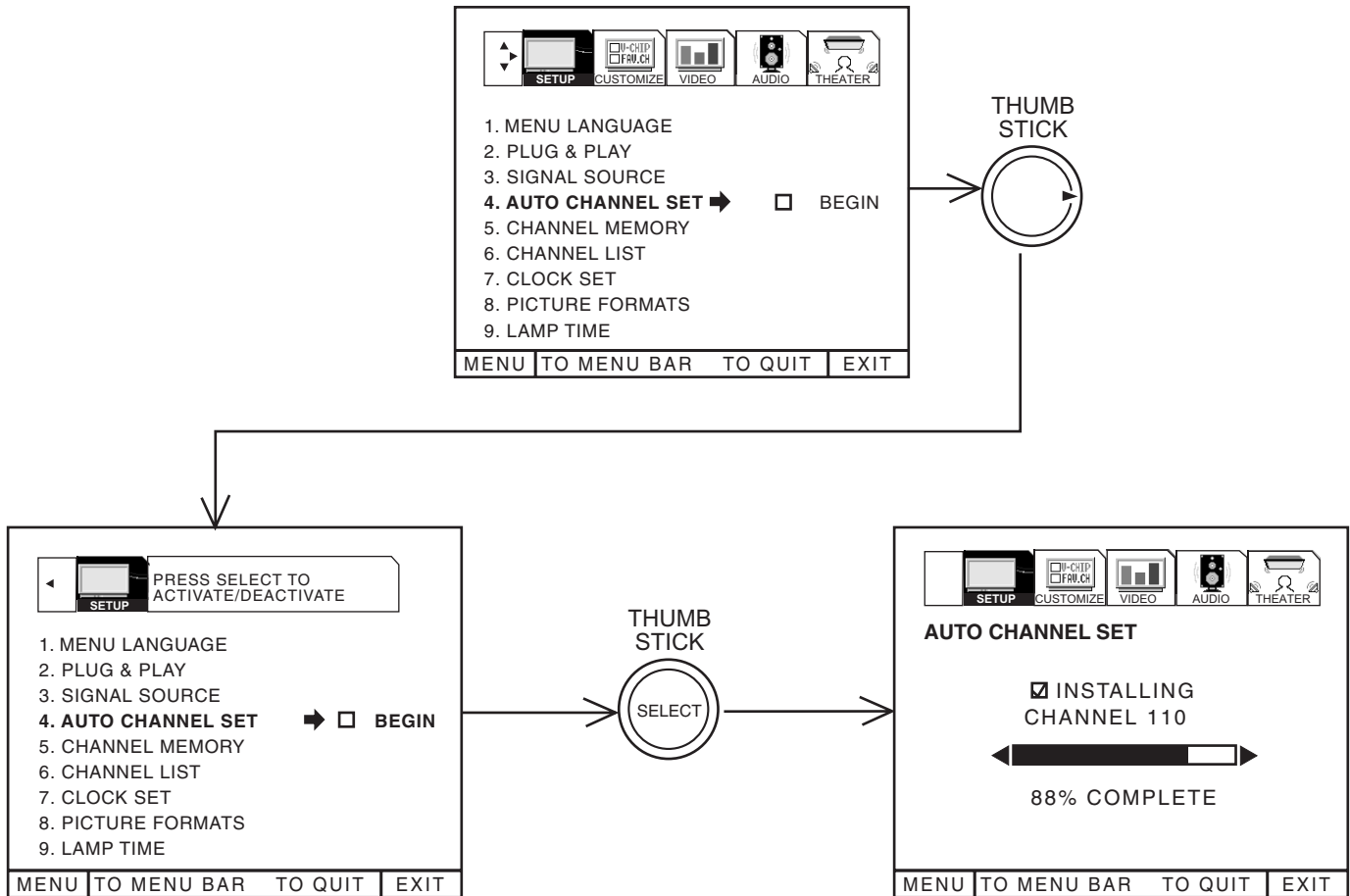

If the EXIT button is pressed while the AUTO CHANNEL SET function is engaged, programming will stop. If two antenna inputs are connected, switch antenna inputs with the INPUT button and repeat AUTO CHANNEL SET for the second antenna input.

Remember to select the correct SIGNAL SOURCE mode before using AUTO CHANNEL SET. See CHANNEL MEMORY to add or to erase additional channels.

SET UP



CHANNEL MEMORY

Use this function after AUTO CHANNEL SET to add or erase additional channels to the remote control CHANNEL ▲ or ▼ buttons.

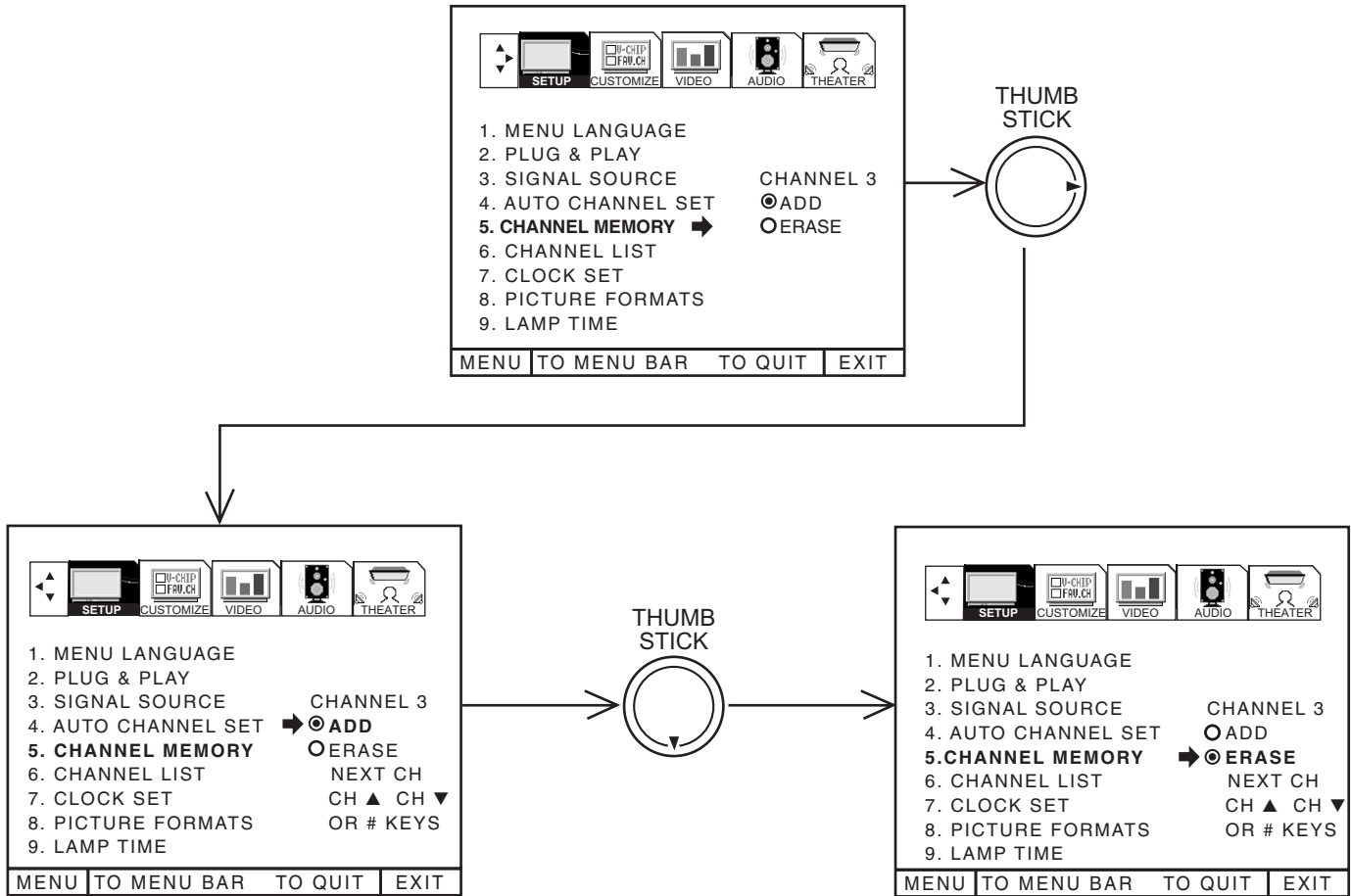

Add or erase additional channels while still in CHANNEL MEMORY using CHANNEL ▲ or ▼ or the number buttons to change the channel.

Press EXIT to quit menu or THUMB STICK ◀ to return to previous menu.



CHANNEL LIST

This function allows you to review which channels are labeled in CHANNEL ID (ID.), which have been added to CHANNEL MEMORY (SCAN), and which are protected by PARENTAL CONTROL (LOCK).

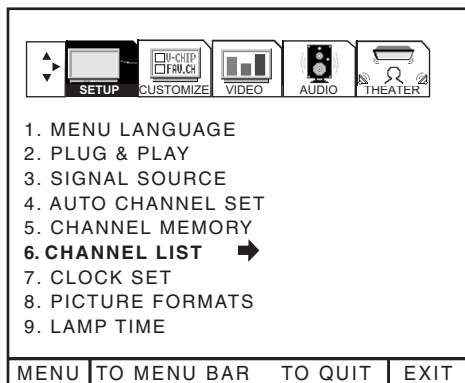

THUMB STICK

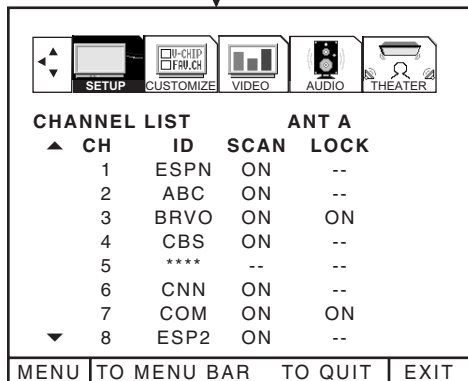
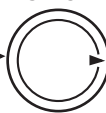

THUMB STICK

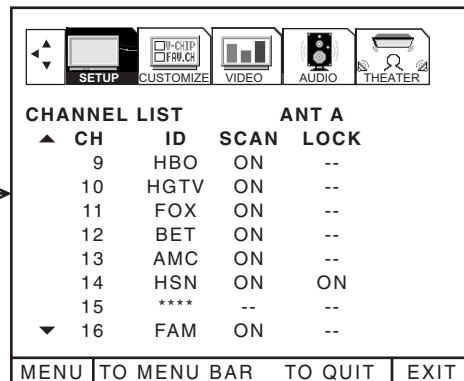

Press THUMB STICK ▲ or ▼ to review more channels.
Press EXIT to quit menu or THUMB STICK ◀ to return to previous menu.

NOTE: Each touch of THUMB STICK ▲ or ▼ will display the next eight channels.

SET UP



CLOCK SET

The time must be set before you can use the 4 EVENT PROGRAM or TV TIME OUT.

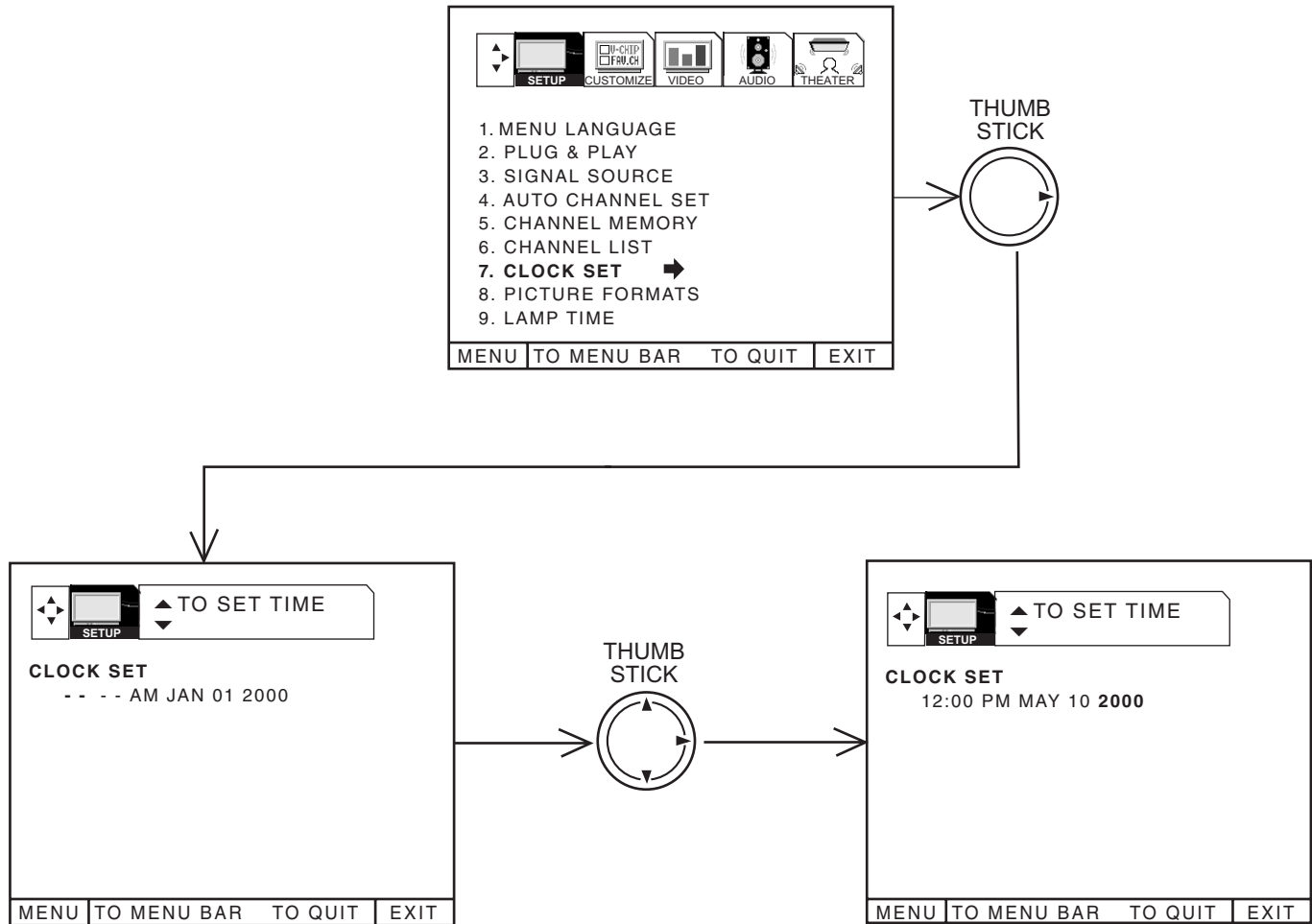

Use THUMB STICK ▲ or ▼ to set the time, date, and year.
Press THUMB STICK ◀ or ▶ to change position.
Press EXIT to quit menu or THUMB STICK ◀ to return to previous menu when the CURSOR is in the first position.

PICTURE FORMATS

The PICTURE FORMATS function is very useful when setting up reception of High Definition, Standard Definition and NTSC signals.

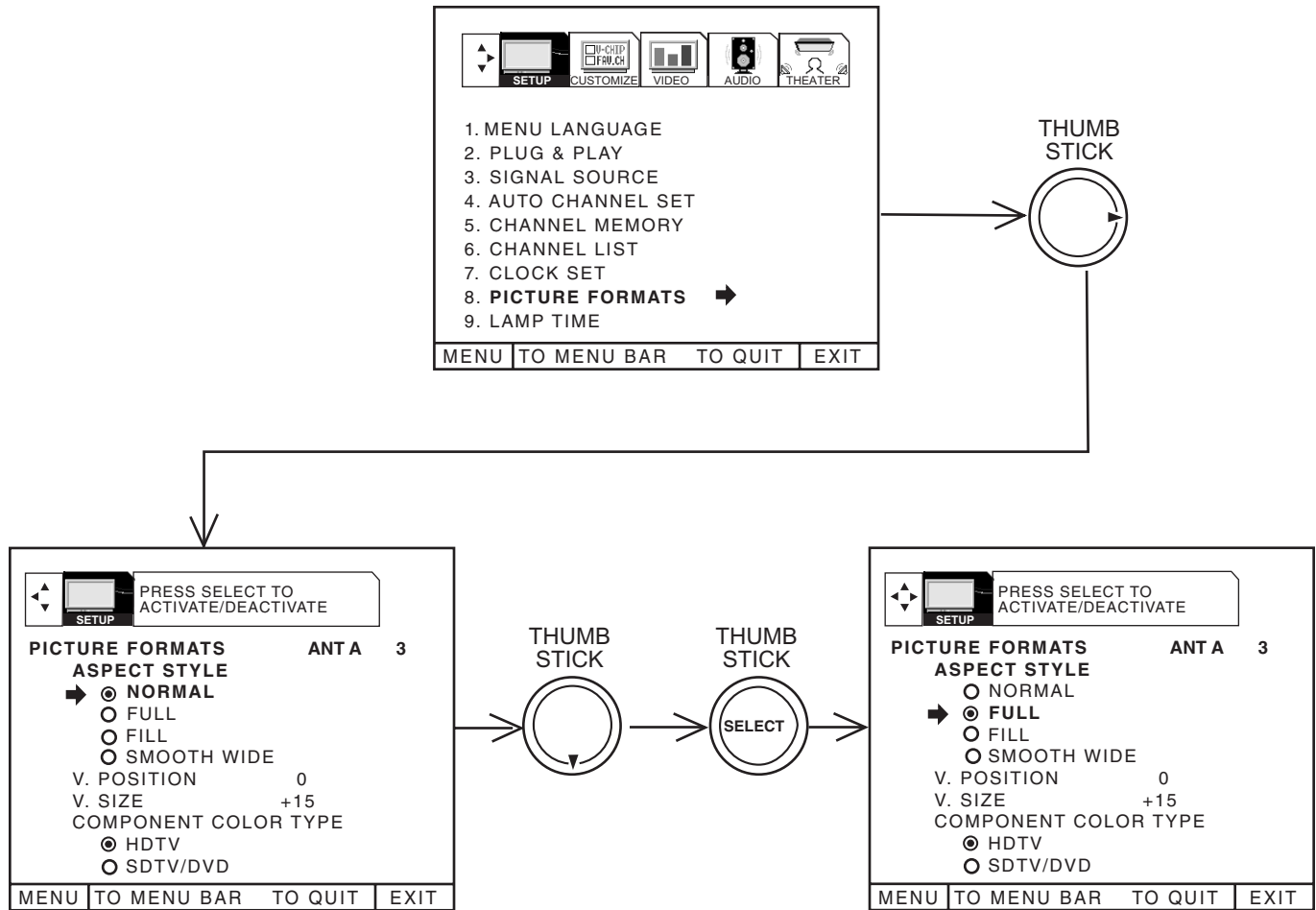

Press THUMB STICK ▲ or ▼ to highlight then press down on THUMB STICK to select Aspect Style (normal, full, fill, smooth wide)
 Press EXIT to quit menu or THUMB STICK ◀ to return to previous menu.
 Press THUMB STICK ▲ or ▼ to highlight V. POSITION, then THUMB STICK ▲ or ▼ to change V. POSITION.
 Press THUMB STICK ▲ or ▼ to highlight V. SIZE, then THUMB STICK ▲ or ▼ to change V. SIZE.
 Press THUMB STICK ▲ or ▼ to highlight then press down on THUMB STICK to select COMPONENT COLOR TYPE.

ASPECT STYLE

If you receive an image with a 4:3 aspect ratio, the image will be displayed at that ratio on your HDTV unless you specify otherwise. The Picture Format menu allows you to adjust the image through the following options:

- Normal** Choose this when receiving a 4:3 image and you want the on-screen appearance of the video to be a centered picture with side panels (blank areas) on the right and left sides.
- Full** Choose this when you want the television to adjust the 4:3 image horizontally so it fills your 16:9 screen. No side panels will be added, and the image is vertically unaltered. This setting is especially useful for viewing 16:9 formatted DVDs.

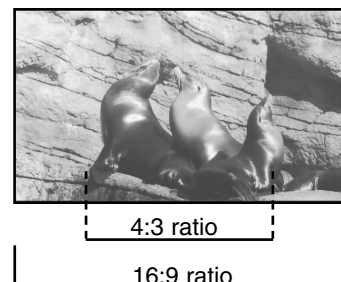



ASPECT STYLE

Fill This function allows you to select when receiving either NTSC or SDTV. Full screen picture is available in this mode when receiving letterbox signal. Both vertical edges will be hidden if you select Fill for ordinary 4:3 picture.

Smooth Wide This function allows you to select when receiving either NTSC or SDTV signal. 4:3 picture is expanded horizontally as being close to both left and right sides. It keeps 4:3 ratio in the center of the picture, then expands as it is close to both left and right edge of the picture to show picture distortion minimized. This function allows you to watch picture without side panel for 4:3.

Some digital (ATSC format) stations may transmit 4:3 images in a way that will not allow expansion. You will be unable to adjust the picture format.

V. POSITION

This function allows you to select when aspect style is either Full or Fill or Smooth Wide. Vertical position can be changed with this mode. For example, it will be useful for centering the picture when there is gray area at both top and bottom of the picture with HDTV signal. Adjustable range is -10 (video center is toward bottom of screen) to +10 (video center is toward top of screen).

V. SIZE

This function allows you to select when aspect style is Fill. It will not be available when selecting other aspect style. It is useful when you wish to change vertical size of the picture. Adjustable range is -15 (video size is narrowed) to +15 (video size is broadened).

COMPONENT COLOR TYPE

This function allows you to automatically change tint and color coordinates for DTV programs.

HDTV - High Definition Television - Use for High Vision Signal Y-P_BP_R from HDTV Set-Top Box.

SDTV /DVD - Standard Definition Television or DVD (Digital Versatile Disc Player) Y-C_BC_R.

- NOTES:**
1. The Aspect Style setting you select for an ANT input will automatically be set for the other ANT input. However, all three video inputs have independent Aspect Style settings.
 2. You will not be able to access the V. Position menu if Aspect Style-Normal is set.
 3. You will not be able to access the V. SIZE menu if Aspect Style - Normal or Full is set.
 4. You will only be able to access the Aspect Style menu when viewing a 4:3-480i or 480P. When viewing a 16:9-1080i or 720P input you will not be able to access this menu.
 5. If COMPONENT COLOR TYPE is set improperly (does not match actual input signal), the color and tint of the main picture will be abnormal.
 6. You must be tuned to VIDEO: 1 or 2 input and have a component hooked up to the Y-P_BP_R input jacks to access this component color type.
 7. All component color type settings will affect only color component input you are currently viewing. If you are using both sets of component input jacks, be sure to set the component color type feature for both inputs.
 8. Adjustable range of V. Position is -20 to +20 when receiving 480P picture.

LAMP TIME

The LAMP TIME counts the hours the lamp has operated.

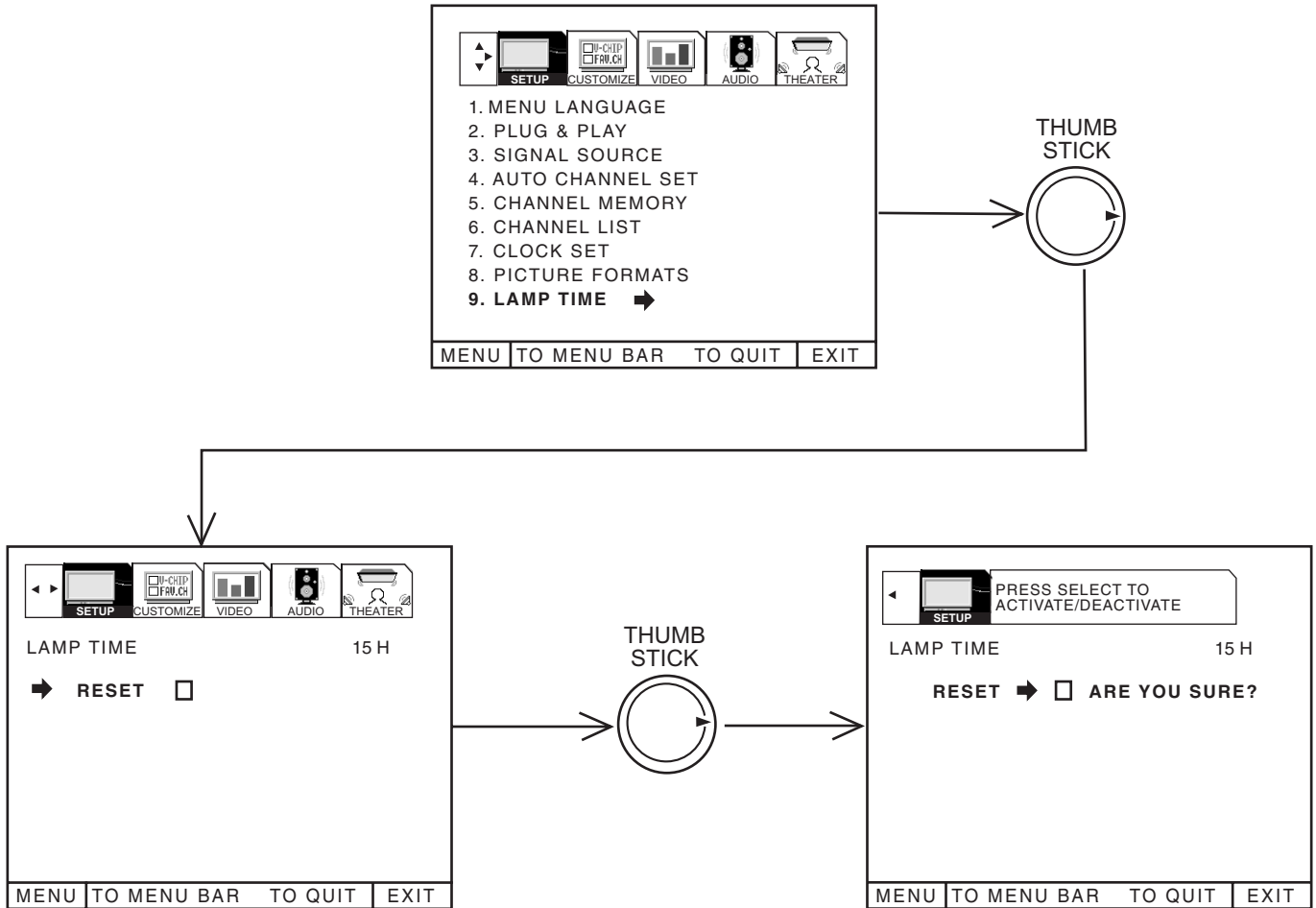

Press SELECT to reset LAMP TIME (after lamp replacement).

NOTE: LAMP TIME should be left on to keep track of time lamp operates.
LAMP TIME should be reset when lamp is replaced.

At around 4,000 hours of operations, the lamp needs to be replaced with a new one. There is a spare lamp for replacement at the rear of the television. See page 79-82 for Lamp Replacement procedure.

NOTE: the lamp should be replaced every 4,000 hours to obtain good picture brightness.



This selection contains advanced features which will make TV viewing easier and more enjoyable.

CHANNEL ID.

Use this feature to give up to 20 channels a name when ANTENNA signal source is selected and up to 60 channels a name when CATV signal source is selected.

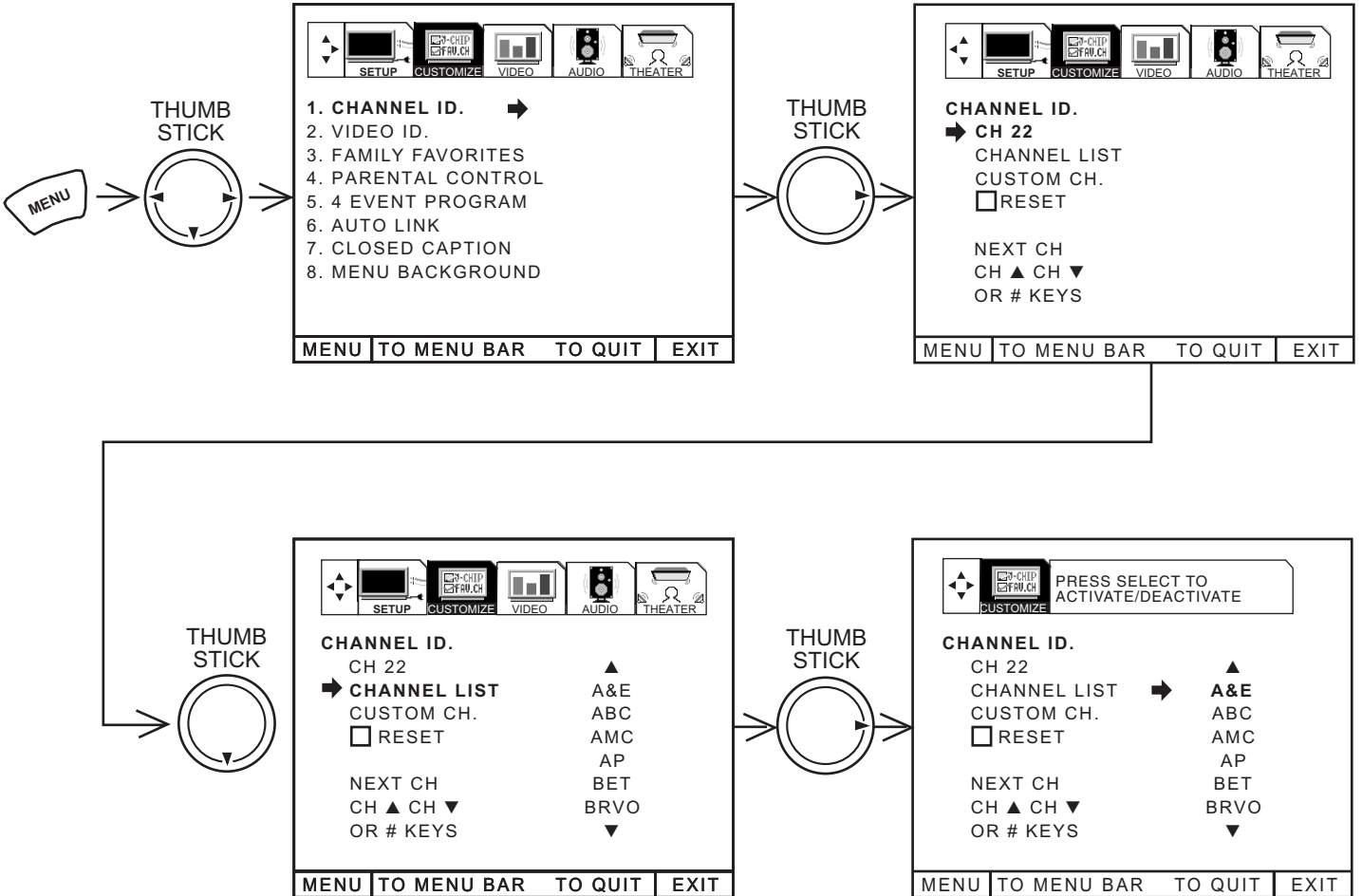

Press THUMB STICK ▼ to highlight CHANNEL LIST.
 Press THUMB STICK ► to select preset CHANNEL LIST.
 Press THUMB STICK ▼ to scroll through the preset CHANNEL LIST.
 Press down on THUMB STICK to select desired CHANNEL ID.

To customize CHANNEL ID, select CUSTOM CH.
 Press THUMB STICK ▲ or ▼ to select letter.
 Press THUMB STICK ◀ or ▶ to change character position.
 (★) represents a blank space.
 Press CHANNEL ▲ or ▼ and the number buttons to label additional channels.
 Press EXIT to quit menu or THUMB STICK ◀ to return to previous menu when the CURSOR is in the first position.

Select RESET to erase a CHANNEL ID.

- NOTES:**
1. If ANT A and ANT B are in the same SIGNAL SOURCE mode (see page 41), the CHANNEL ID for both antenna inputs will be the same.
 2. CHANNEL ID will be displayed only when channel is displayed as main picture.

VIDEO ID.

Use this feature to give a name to any of the three video inputs.

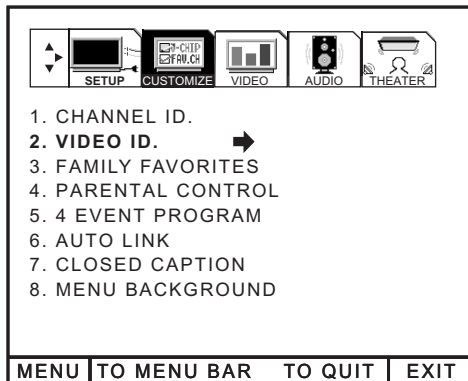

THUMB STICK

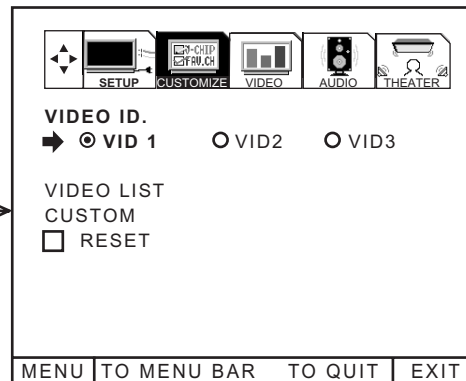

THUMB STICK

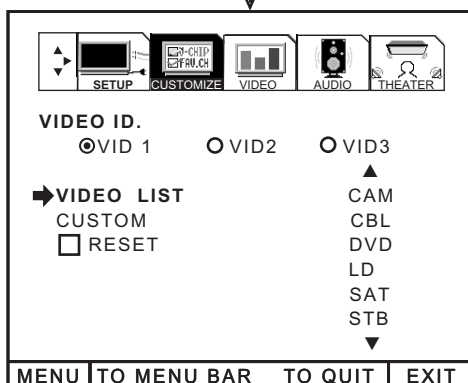

THUMB STICK

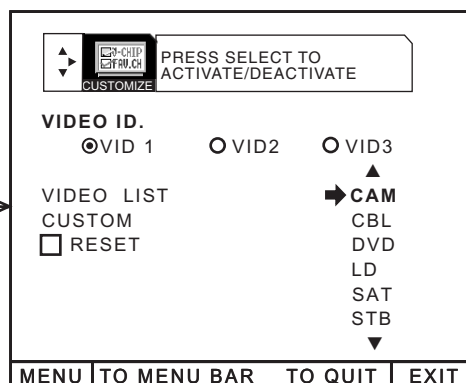

Press THUMB STICK ▼ to highlight VIDEO LIST.
 Press THUMB STICK ► to select preset VIDEO LIST.
 Press THUMB STICK ▲ or ▼ to scroll through the preset VIDEO LIST.
 Press down on THUMB STICK to select desired VIDEO ID.

To customize VIDEO ID, select CUSTOM.
 Press THUMB STICK ► to select the video input to be named.
 Press THUMB STICK ▲ or ▼ to select letters.
 Press THUMB STICK ► or ◀ to change position.
 Press EXIT to quit menu or THUMB STICK ◀ to return to previous menu when the CURSOR is in the first position.
 (★) represents a blank space.

Select RESET to set VIDEO ID to original condition.

NOTE: VIDEO ID will be displayed only when VIDEO input is displayed as main picture.

FAMILY FAVORITES (MENU)

This function allows you to group your favorite channels into six personalized categories that you can rename. A total of 36 channels can be stored in the FAMILY FAVORITES function.

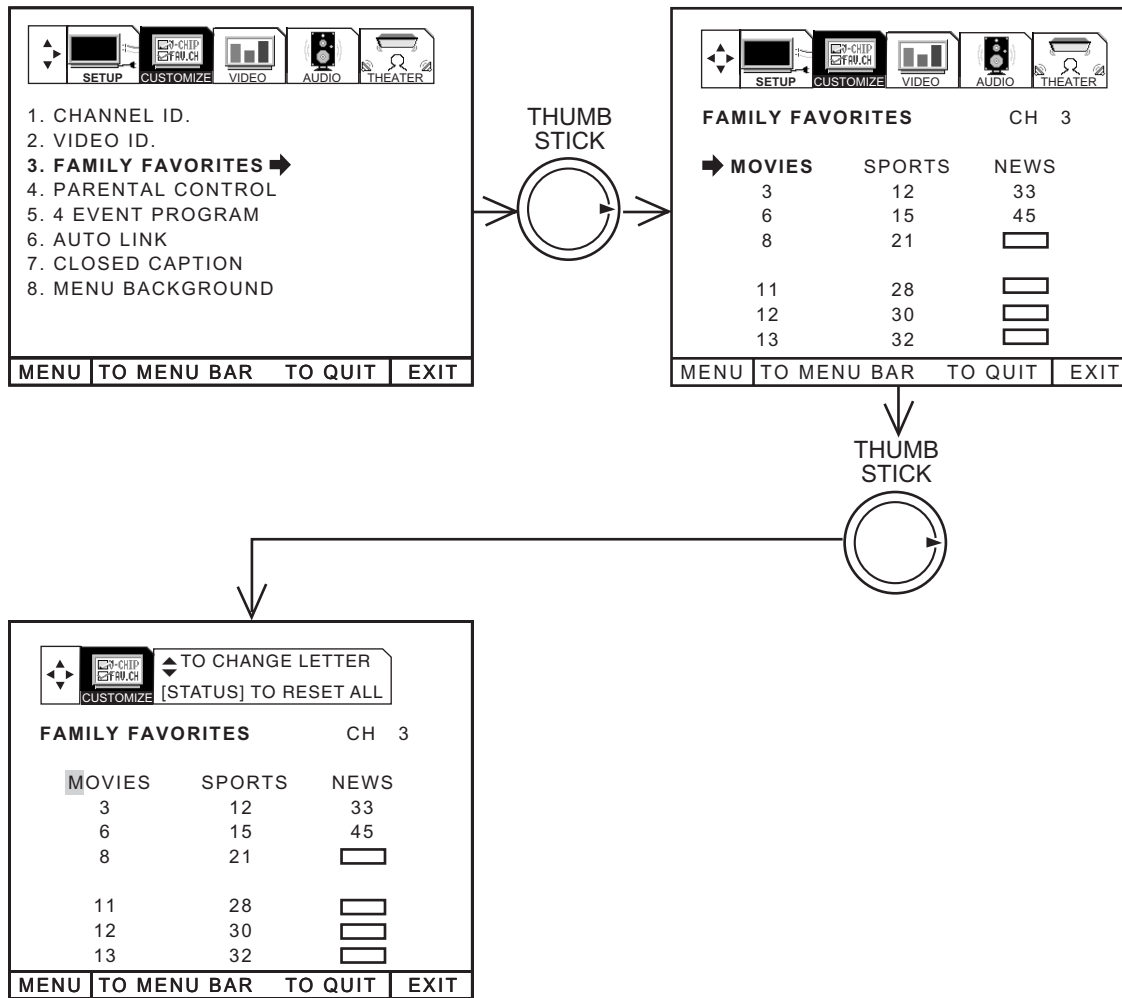

Channel stored with AUTO CHANNEL SET will automatically be stored in FAMILY FAVORITES.

To rename the categories, use the THUMB STICK to highlight the category you would like to rename. Use THUMB STICK ▲ or ▼ to change a letter and THUMB STICK ► to select the next character to change.

To enter a channel into a category, highlight the channel location to be stored. Press CHANNEL ▲ or ▼ or the number buttons to enter the desired channel. Repeat until category has been set with your favorite channels. The channel to be added is displayed in the top right corner of the screen. Enter channel 00 to erase a favorite channel.

To reset categories and channels back to original factory preset, press STATUS while you are renaming a category.

- NOTES:**
1. This function cannot be accessed when ANT B is the main channel.
 2. When the input source is not ANT A, the message "PLEASE SWITCH TO ANT A" will appear.
 3. Each category contains 2 groups of 3 channels, for a total of 6 channels per category.

FAMILY FAVORITES (OPERATION)

Use this function to display FAMILY FAVORITES selections as sub-pictures or to tune the main picture to a desired favorite channel.

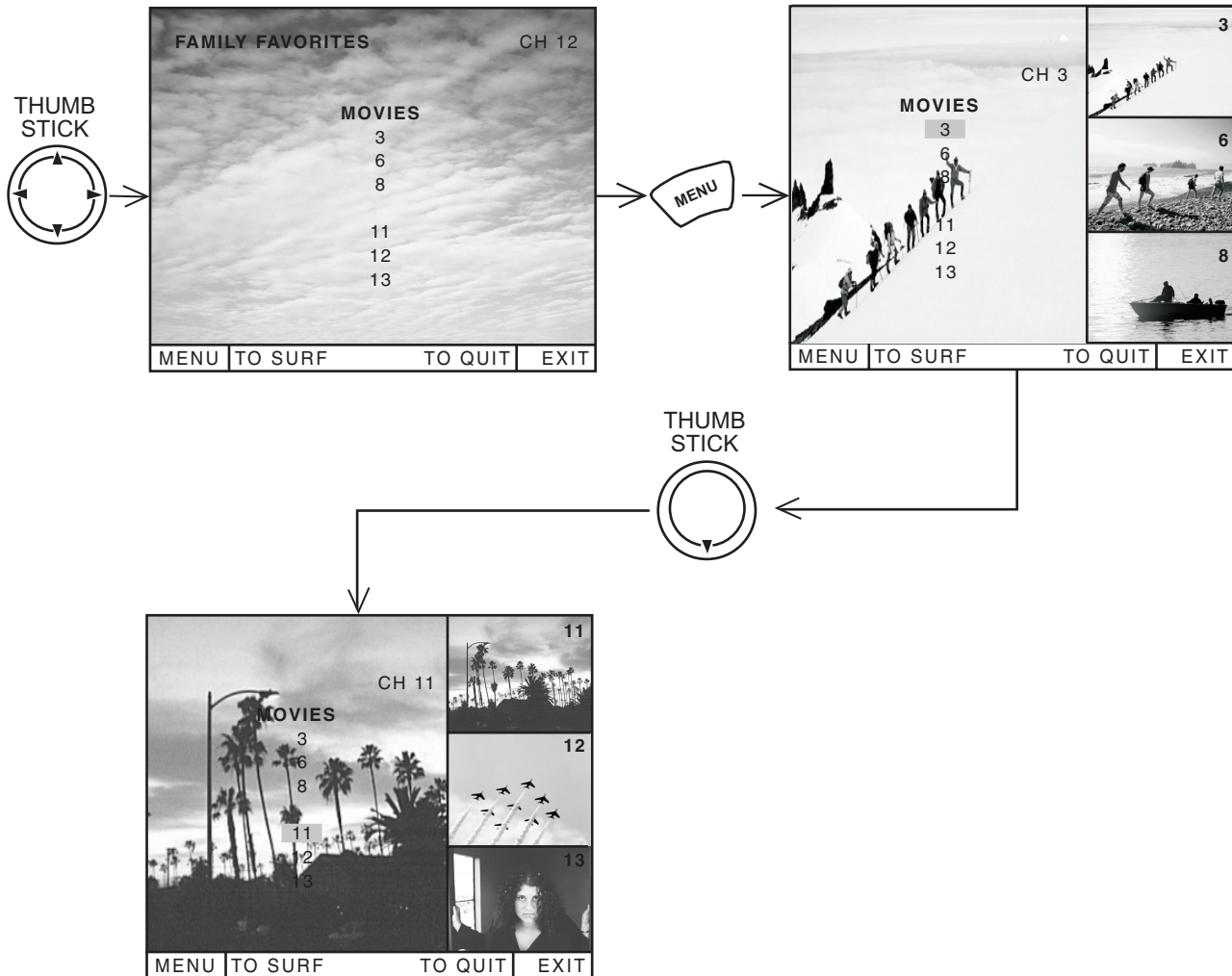

Select a category using THUMB STICK ◀ or ▶.

Press MENU and the category will be displayed as sub-pictures at the right edge of the screen. This is useful for previewing a category.

Use THUMB STICK ◀, ▶, ▲ or ▼ to highlight a favorite channel and the TV will automatically tune to that channel.

Press EXIT to remove FAMILY FAVORITES OSD from the screen.

- NOTES:**
1. If a category has some blank channel entries, these channels will appear as black sub-pictures.
 2. Each category contains 2 groups of 3 channels. Pressing the MENU button will display only 1 group per category, depending on which group you select.

PARENTAL CONTROL

This function will block out the picture and sound of the selected channel or video input. It can also be used to keep the TV from being viewed for a scheduled amount of time that you set.

The code to enter PARENTAL CONTROL is a four digit secret code number. The factory preset code is 0000. Use the number buttons to select secret code.

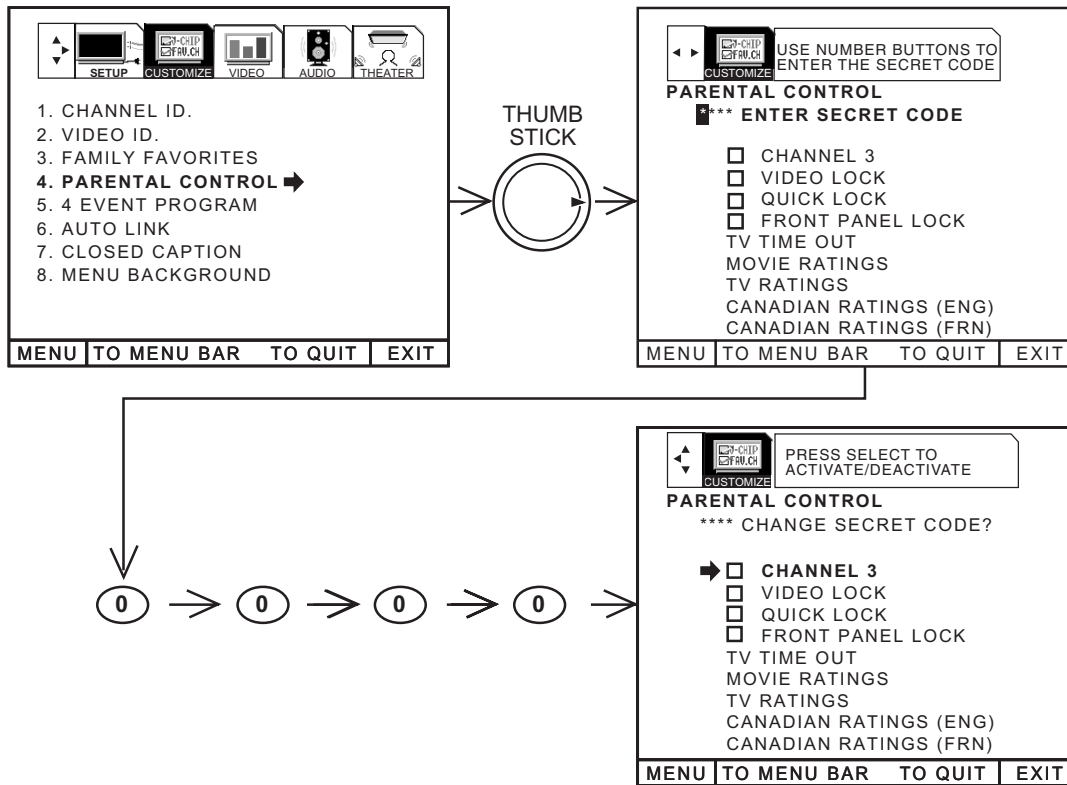

Use THUMB STICK ▲ or ▼ to highlight function and press down on the THUMB STICK to set ON or OFF.

When CHANNEL is turned on, the picture and sound for the chosen channel will be blocked out.

When VIDEO LOCK is turned on, the picture and sound for all video inputs will be blocked out. To lock the video inputs, you must be tuned to one of the video inputs.

When QUICK LOCK is turned on, the picture and sound for channels 3, 4 on both ANT A/B and all video inputs will be blocked out.

When FRONT PANEL LOCK is turned on, all buttons on the Front Panel will be deactivated, except the POWER button.

When TV TIME OUT is turned on, you can set the BEGIN and END times and the TV cannot be viewed during that time period. (Set clock first.) Use THUMB STICK ▲ or ▼ to highlight ONCE (TV will time out one time only), DAILY (TV will time out every day), WEEKLY (TV will time out one time a week) or OFF (to disable this function) and then press down on THUMB STICK to SELECT your choice.

MOVIE RATINGS, TV RATINGS, and CANADIAN RATINGS are explained in detail in the Parental Control Movie/TV Ratings Reference Guide.

To change the secret code number, select CHANGE SECRET CODE. Enter a new four digit key number you prefer.

If you forget your secret code, use the factory code 7777 to erase your key number. This will reset the secret code number back to the factory preset 0000.

Press EXIT to quit menu or THUMB STICK ◀ to return to previous menu.

- NOTE:**
1. If ANT A and ANT B are in the same SIGNAL SOURCE mode (see page 41), when a channel is locked, it is locked on both antenna inputs.
 2. When using TV TIME OUT make sure the clock is set (see page 45).
 3. When the STATUS button is pressed, text appears on the screen to indicate that CHILD LOCK is activated.

4 EVENT PROG.

This function will automatically turn the TV on and off, one time only, every day, or once a week.

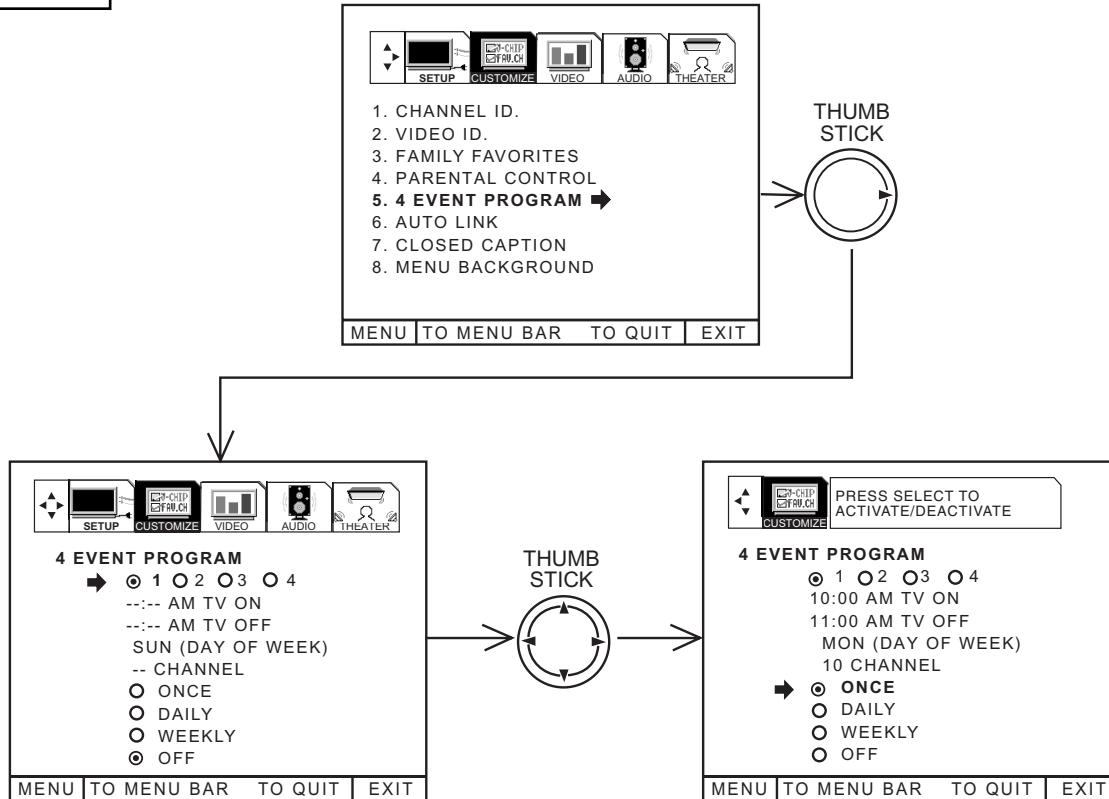

Press THUMB STICK ► to select PROGRAM 1, 2, 3, or 4.

Press THUMB STICK ▲ or ▼ to select the time the TV will turn on and off.

Use THUMB STICK ► to change position.

Press THUMB STICK ▲ or ▼ to select the day of the week you want the timer to turn on TV. (If you set timer to turn on DAILY, do not need to set DAY OF WEEK).

Press THUMB STICK ▲ or ▼, CHANNEL (▲) or (▼), or number buttons to set the channel the TV will tune to when it automatically turns on.

Press THUMB STICK ▲ or ▼ to highlight, then press down (SELECT) on the THUMB STICK to select mode ONCE (TV will turn on/off one time only), or mode DAILY (TV will turn on/off at the same time every day), WEEKLY (TV will turn on/off at same time every week) or OFF (to disable this function).

Press EXIT to quit menu or THUMB STICK ◀ to return to previous menu.

If the clock is not set, you can not use this function and the screen below will appear.

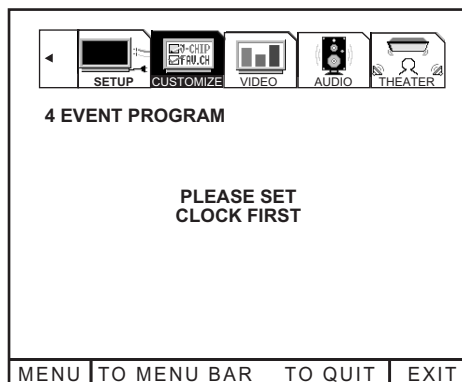

- NOTES:**
1. The OFF Timer will only activate if the TV was turned on or tuned with the ON Timer and no channel selection was made after this time. If you change the channel after the ON Timer has been activated, the OFF Timer will deactivate.
 2. If no remote control button is pressed after ON Timer is activated, the TV will automatically turn off after three hours.



CAUTION: Do not use your TV as a deterrent when away from home by using the ON and OFF TIMERS. For safety, the TV should be turned off when you are away from home.

AUTO LINK

Use this function to automatically turn the TV on and tune to VIDEO: 1, 2 or 3 when it detects a VIDEO input.

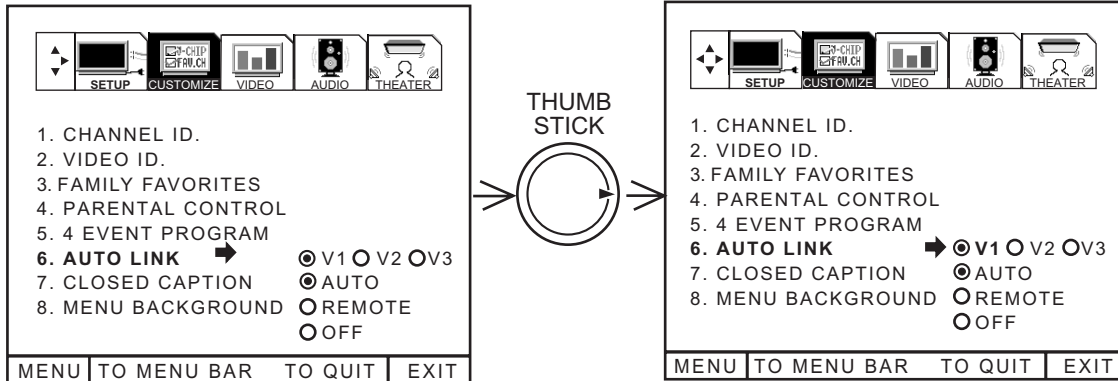

Use THUMB STICK ► to select Video Input.

Use THUMB STICK ▲ or ▼, then press down (SELECT) on THUMB STICK to change AUTO LINK setting.

When AUTO is selected, the TV will turn on and tune to VIDEO: 1, 2 or 3 automatically, when the VIDEO: 1, 2 or 3 input device is turned on. This is convenient when you want to watch a movie with your VCR, laserdisc player, or DVD player.

When REMOTE is selected, the TV will turn on and tune to VIDEO: 1, 2 or 3 automatically, when the VIDEO: 1, 2 or 3 input device is turned on and the VCR, laserdisc, or DVD play button on your remote control is pressed.

This is convenient when you want to record a movie with your VCR and watch it later.

Select OFF to disable this function.

Press EXIT to quit menu or THUMB STICK ◀ to return to previous menu.

- NOTES:**
1. Once the TV has been turned on using the AUTO LINK feature, it must be reset before AUTO LINK is used again. To do this, turn your VCR, laserdisc, or DVD player OFF. This feature is now reset and will turn on your TV as described above.
 2. When using REMOTE mode, any remote control button will substitute for your video input device play button. However, intended operation is for use with your VCR, laserdisc, or DVD play button.

CLOSED CAPTION

Closed Captions are the dialogue, narration, and/or sound effects of a television program or home video which are displayed on the TV screen. Your local TV program guide denotes these programs as **CC** or .

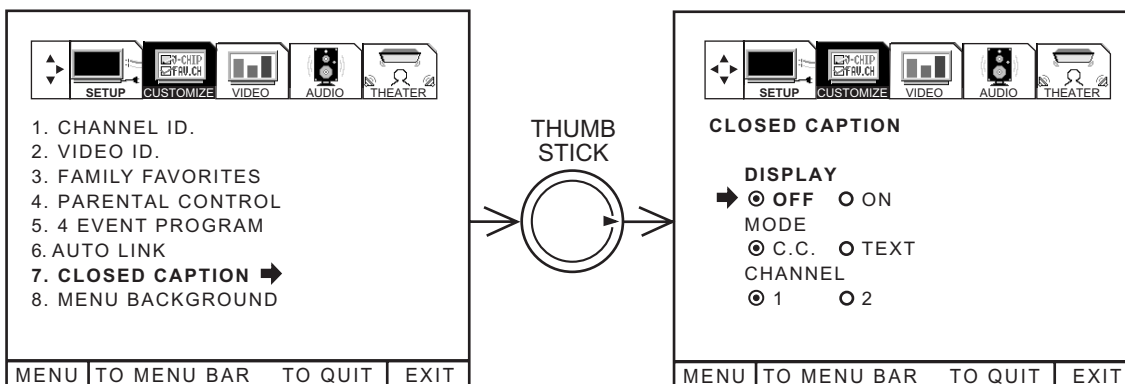

DISPLAY: ON/OFF will turn the **CC** display on or off.

MODE: C.C. (Closed Caption) is for the program you are viewing.

TEXT is for additional information such as news reports or a TV program guide. This information covers the entire screen and viewing the TV program is not possible. TEXT may not be available with every **CC** program.

CHANNEL: 1 is used for the primary language (usually English).
2 is sometimes used for a second language (may vary by region).

Use THUMB STICK ▲ or ▼ to highlight the function to change then press THUMB STICK ► to change the function. Press EXIT to quit menu or THUMB STICK ◀ to return to previous menu.

NOTE: CLOSED CAPTION will not work when viewing a 480P, 720P, or 1080i input via the COMPONENT: Y-P_BP_R inputs.

MENU BACKGROUND

This function allows you to choose from three menu backgrounds.

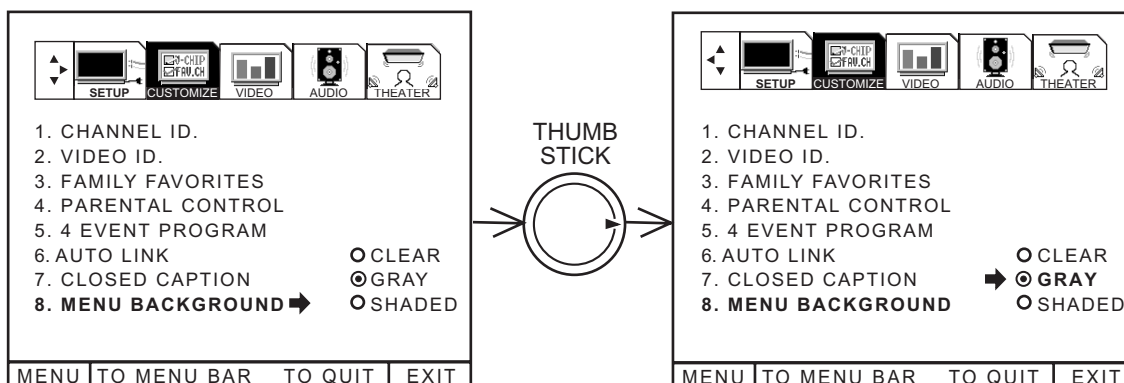

Use THUMB STICK ▲ or ▼ to change MENU BACKGROUND setting. Press EXIT to quit menu or THUMB STICK ◀ to return to previous menu. Select CLEAR and no background is visible, select GRAY and a gray background is visible (no picture can be seen behind menu screen), select SHADED and a light background is visible.



Select VIDEO to adjust picture settings and improve picture quality.

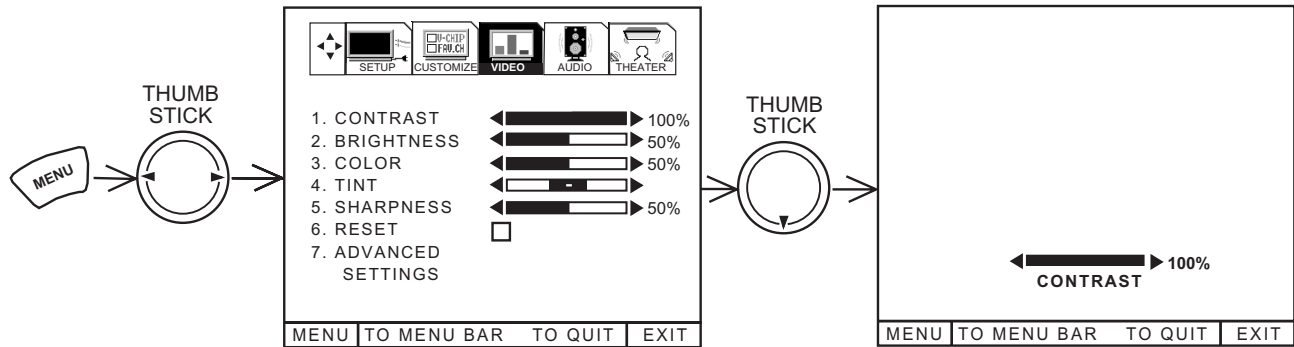

Use the THUMB STICK ▲ or ▼ to highlight the function to be adjusted.
 Press the THUMB STICK ◀ or ▶ to adjust the function.
 Press EXIT to quit menu.

NOTE: If CONTRAST is selected, you are adjusting CONTRAST. The additional menu items BRIGHTNESS, COLOR, TINT, and SHARPNESS can be selected and adjusted in the same manner.

- | | |
|-------------------|---|
| CONTRAST | Use this function to change the contrast between black and white levels in the picture. This adjustment will only affect the picture when ADVANCED SETTINGS PERFECT PICTURE is OFF. (see page 58) |
| BRIGHTNESS | Use this function to adjust overall picture brightness. |
| COLOR | Use this function to adjust the level of color in the picture. |
| TINT | Use this function to adjust flesh tones so they appear natural. |
| SHARPNESS | Use this function to adjust the amount of fine detail in the picture. |
| RESET | When RESET is selected, press down (SELECT) on THUMB STICK to return video adjustments to factory preset conditions. |

- NOTES:**
1. It may be necessary to adjust TINT to obtain optimum picture quality when using the COMPONENT VIDEO Y-P_BP_R input jacks.
 2. If you are using the COMPONENT VIDEO input jacks (Y-P_BP_R) and notice that the TINT and COLOR are abnormal, check to make sure that PICTURE FORMATS - COMPONENT COLOR TYPE is set properly. (see page 47)

ADVANCED SETTINGS

Your MARANTZ Projection TV has a PERFECT PICTURE function which will automatically adjust picture settings to produce the highest quality picture possible. When PERFECT PICTURE is highlighted, press down on THUMB STICK to turn the PERFECT PICTURE on or off.

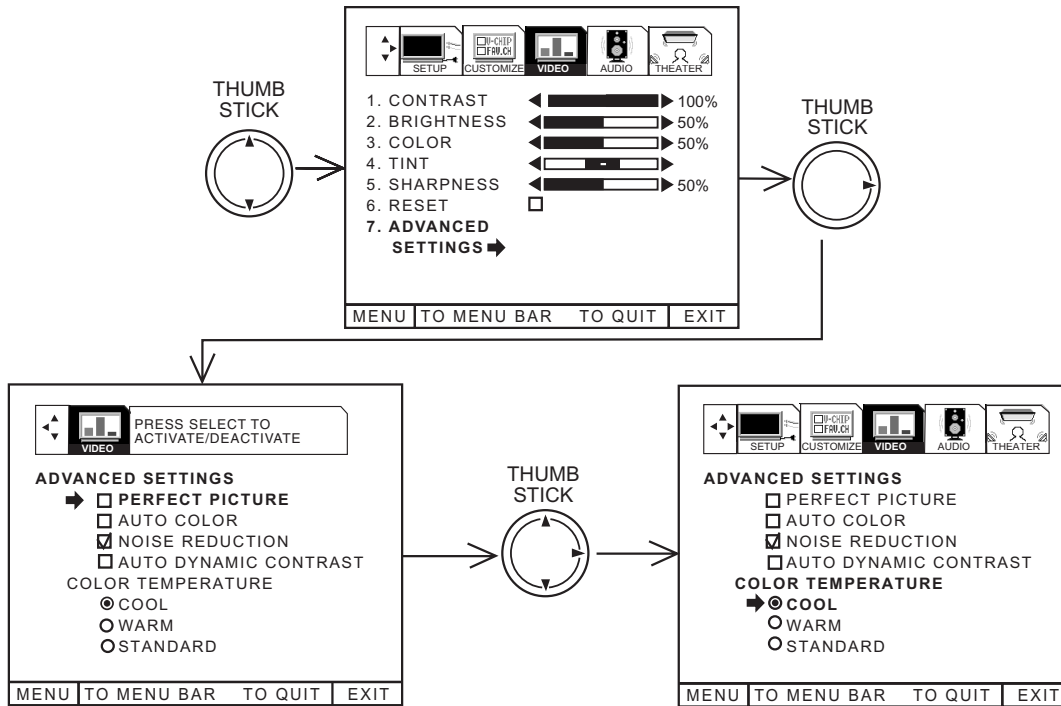

Use THUMB STICK ▲ or ▼ to select function.

Press down on THUMB STICK to select the function setting. When the function has an “✓” in the box, it is ON.

Use THUMB STICK ► to change COLOR TEMPERATURE. When the function shows a “⊙”, it is selected.

Press EXIT to quit menu or THUMB STICK ◀ to return to previous menu.

PERFECT PICTURE

When the PERFECT PICTURE function is on, the TV's internal computer will perform the following:

1. Automatically monitor and adjust contrast depending on room lighting (sensor is located in the front panel) to produce a more natural picture.
2. Automatically monitor and adjust color levels and maintain natural flesh tones.
3. Automatically compensate for weak or strong TV signals to produce a clear picture.

Turn the PERFECT PICTURE function off to control other PREFERENCE SETTINGS.

AUTO COLOR

The AUTO COLOR function automatically monitors and adjusts the color to maintain constant color levels even after a program or channel changes. It also maintains natural flesh tones while preserving fidelity of background colors. (This function will automatically be set to on and cannot be turned off when the PERFECT PICTURE function is ON.) This function does not operate with a COMPONENT: Y-P_BP_R input signal.

NOISE REDUCTION

The NOISE REDUCTION function automatically reduces conspicuous noise in the picture without degrading picture quality. (This function will automatically be set to on and cannot be turned off when the PERFECT PICTURE function is ON.)

AUTO DYNAMIC CONTRAST

The AUTO DYNAMIC CONTRAST function automatically monitors and adjusts the color to maintain constant contrast levels even after a program or channel changes. It also maintains natural flesh tones while preserving fidelity of background colors. (This function will automatically be set to on and cannot be turned off when the AUTO DYNAMIC CONTRAST function is ON.) This function does not operate with a COMPONENT: Y-P_BP_R input signal.

COLOR TEMPERATURE

Set this to WARM for hotter colors with more red, or set to COOL for less intense colors with more blue or STANDARD for standard color.



Select AUDIO to adjust the TV to your preference and to improve the sound quality.

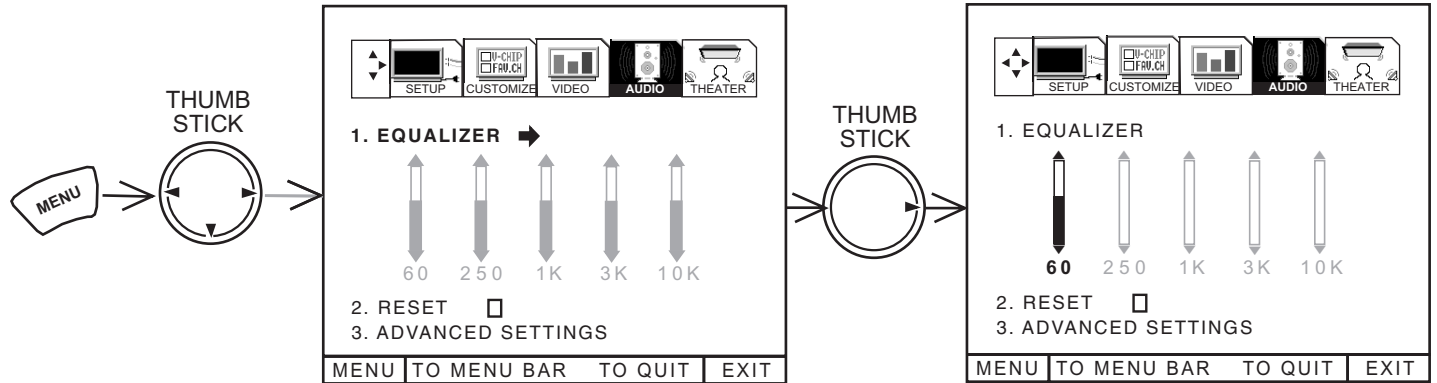

Use THUMB STICK ▲ or ▼ to highlight the function to be adjusted.

When EQUALIZER is highlighted, press THUMB STICK ► to select the frequency you would like to adjust (60, 250, 1K, 3K or 10K).

Then use THUMB STICK ▲ or ▼ to adjust selected frequency.

When RESET is highlighted, press down on THUMB STICK to reset EQUALIZER settings to factory conditions.

Press EXIT to quit menu.

NOTE: When DYNAMIC BASS is turned ON, the 60Hz level signal will automatically be increased.



ADVANCED SETTINGS

Use ADVANCED SETTINGS to improve the sound performance of your TV, depending on listening conditions.

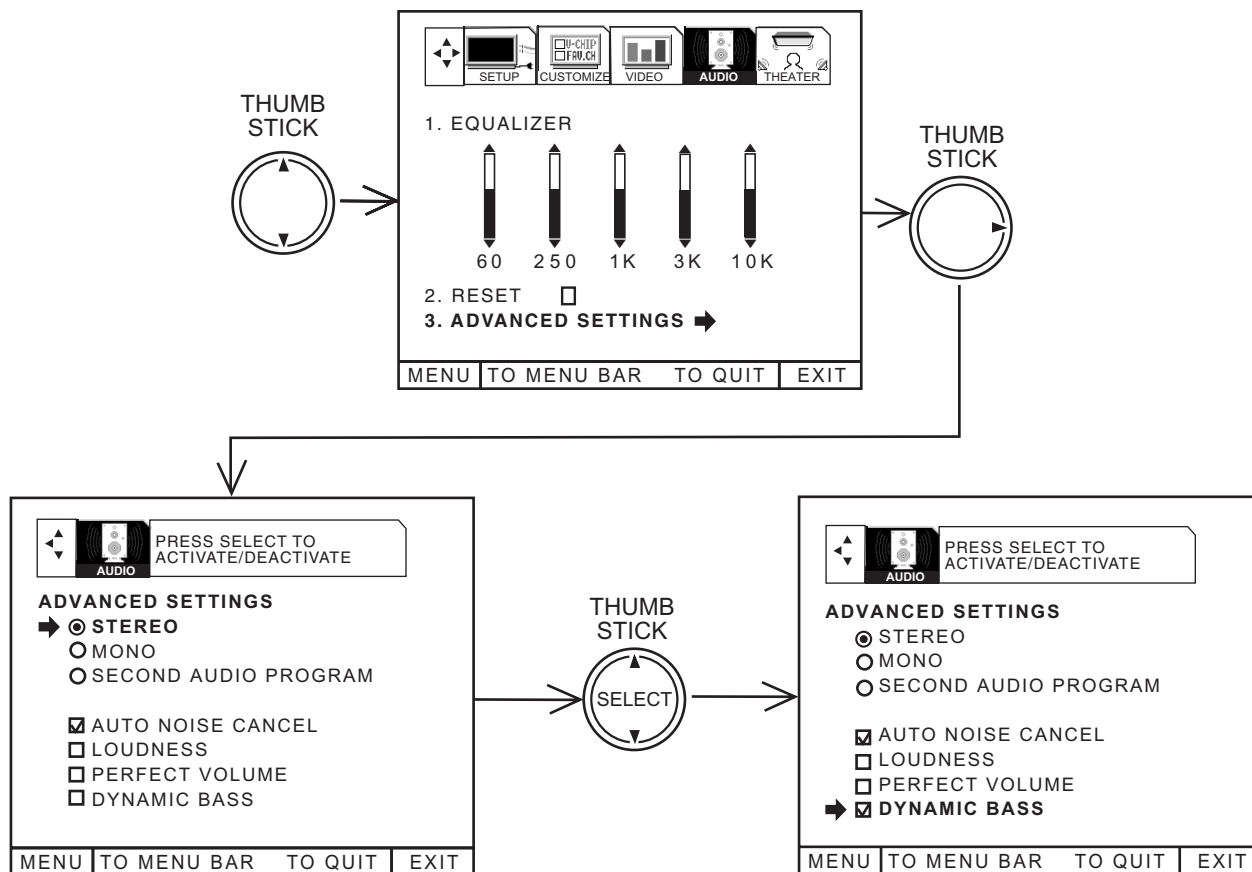

Press THUMB STICK ▲ or ▼ to highlight a function. Press down on THUMB STICK to change the function setting. When the function has a “✓” in the box it is ON, when it has a “⊙” it is selected.

MTS MODE

Multi-Channel Television Sound will allow you to select STEREO (a stereo broadcast), MONO (monaural sound) used when receiving a weak stereo broadcast or SAP (second audio program) which may be a secondary language, weather report, etc.

The sources received will be displayed at the top center edge of the TV. The source you select will be displayed above the sources received. See example below for each selection when both stereo and second audio are received (monaural is always received).

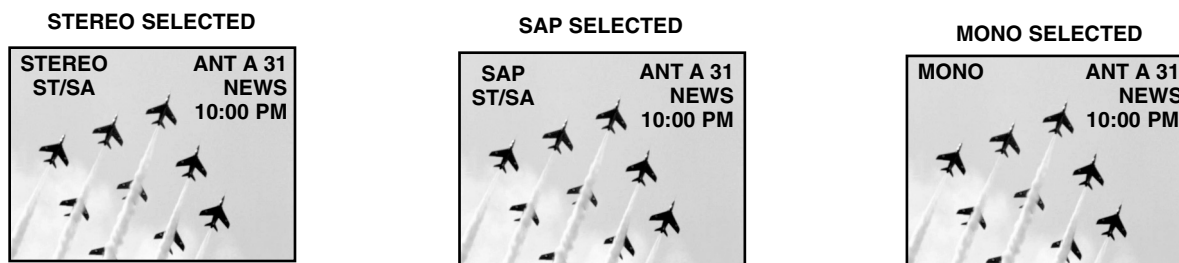

AUTO NOISE CANCEL

This function eliminates the noise between stations. If a channel is tuned and is noisy, this function will automatically eliminate the audio for that channel.

LOUDNESS

This function will improve the quality of both low and high frequency sounds when listening at low volume levels.

PERFECT VOLUME

This function will automatically adjust volume so each channel has the same average volume level. This function will automatically be disabled when SURROUND PRO LOGIC or SURROUND DOLBY DIGITAL are selected, or DIGITAL AUDIO is inputted, to ensure correct SURROUND sound decoding. (See pages 63-64)

DYNAMIC BASS

This function allows you to enjoy spectacular bass sound that would normally be heard only with expensive home speaker systems.

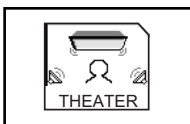

Use this function to choose picture and audio settings for a true home THEATER experience.

THEATER MODES

Use this function to choose from automatic picture settings to optimize your TV's performance.

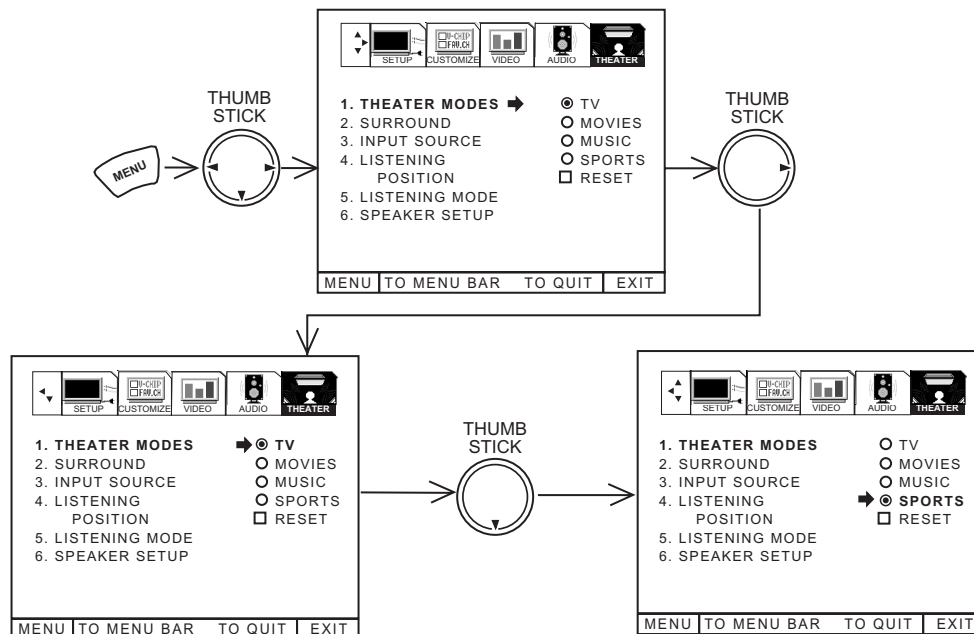

Use THUMB STICK ▲ or ▼ to change THEATER MODES settings.

When TV mode is chosen, the following are automatically set:

CONTRAST - 100%, COLOR TEMPERATURE - COOL, EQUALIZER is set to center, LOUDNESS - ON, PERFECT VOLUME - ON, DYNAMIC BASS - OFF, SURROUND - OFF, AUTO DYNAMIC CONTRAST - ON.

When MOVIES mode is chosen, the following are automatically set:

CONTRAST - 100%, COLOR TEMPERATURE - WARM, EQUALIZER set to center, LOUDNESS - OFF, PERFECT VOLUME - OFF, DYNAMIC BASS - ON, SURROUND - PRO LOGIC, AUTO DYNAMIC CONTRAST - ON.

NOTE: MOVIE MODE 3:2 PULLDOWN DETECTION SPECIAL FEATURE

Theatrical movies are shot on film at 24 frames or still pictures per second, instead of 30 frames or 60 fields like video. When film is transferred to video for television viewing, the disparity between the two frame rates must be reconciled. This involves a process known as 3:2 pulldown.

When MOVIE MODE is selected from the THEATER menu, your Marantz Projection Television will activate the circuitry for this special feature to improve video performance when watching film based sources. This 3:2 pulldown detection will only work in MOVIE MODE.

When MUSIC mode is chosen, the following are automatically set:

CONTRAST - 100%, COLOR TEMPERATURE - COOL, EQUALIZER set to enhance low and high frequency range, LOUDNESS - OFF, PERFECT VOLUME - OFF, DYNAMIC BASS - OFF, SURROUND - ROCK ARENA, AUTO DYNAMIC CONTRAST - OFF.

When SPORTS mode is chosen, the following are automatically set:

CONTRAST - 100%, COLOR TEMPERATURE - COOL, EQUALIZER set to center, LOUDNESS - OFF, PERFECT VOLUME - OFF, DYNAMIC BASS - ON, SURROUND - STADIUM, AUTO DYNAMIC CONTRAST - OFF.

You can customize each of the above modes (TV, MOVIE, MUSIC and SPORTS) to your preference to increase viewing performance and pleasure, depending upon the video program being viewed. However, if RESET is selected, all modes will reset to the initial conditions as explained above.

When RESET is selected, it will take approximately two seconds to return to factory conditions (SPORTS mode).

Press EXIT to quit menu or THUMB STICK ◀ to return to previous menu.



SURROUND

The following surround settings will reproduce the “live” sound you would hear in concert halls, sports stadiums, movie theaters, etc. when you set up your speaker system as shown in the section on audio system setup on pages 22-23. The surround system is most effective with movie and other stereo material that is Dolby Surround encoded.

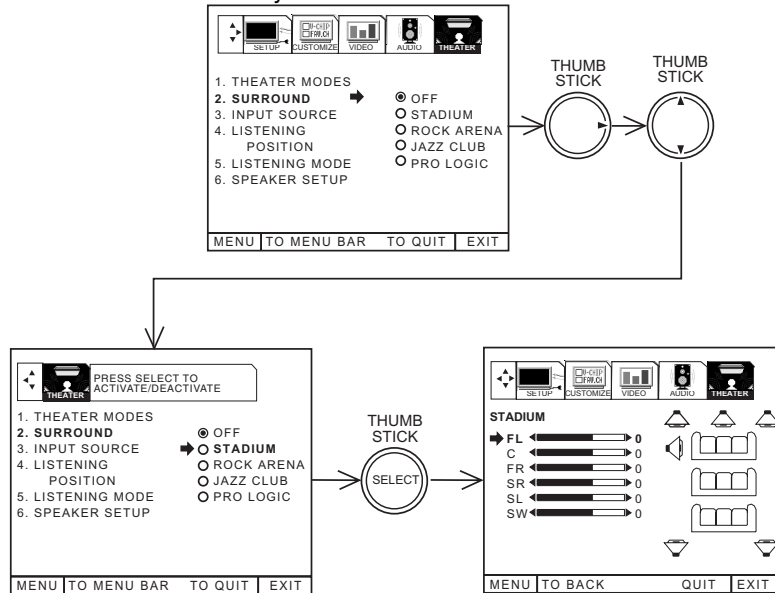

To enter the SURROUND MODE, use THUMB STICK ▲ or ▼ to highlight then press down on THUMB STICK to select SURROUND MODE of your choice.

Now press THUMB STICK ▲ or ▼ to select speaker to be adjusted.

Use THUMB STICK ◀ or ▶ to adjust the volume of the highlighted speakers. MAIN volume also controls AUDIO TO HI-FI output level. Adjust MAIN volume first.

Each SURROUND setting has separate FL (Front Left), C (Center), FR (Front Right), SR (Surround Right), SL (Surround Left), and SW (Sub Woofer) volume controls, except OFF, which has only balance and SW (Sub Woofer) controls.

All speaker volumes will increase or decrease when the main VOLUME is set.

The maximum volume allowed for the CENTER, REAR, and SUB WOOFER will depend on how loud the MAIN volume is set.

SURROUND OFF

Use this for normal stereo/mono broadcasts.

STADIUM SURROUND

Select this mode to simulate being at a sporting event.

ROCK ARENA SURROUND

Select this mode to simulate being at a medium sized Rock Arena.

JAZZ CLUB SURROUND

Select this mode to simulate being at a small Jazz Club.

PRO LOGIC SURROUND

Select this mode when viewing a program which is DOLBY PRO LOGIC encoded. (see page 63 for more information)

DOLBY DIGITAL SURROUND

Select this mode when viewing a program which is DOLBY DIGITAL encoded and you have a digital (optical or coaxial) input. (see pages 64 and 65 for more information)

- NOTES:**
1. This TV can not decode or process DTS (Digital Theater Surround).
 2. If you can not adjust SR, SL, or SW, make sure they are turned on in the THEATER - SPEAKER SETUP menu. (see page 67)
 3. “PROLOGIC” indication in surround menu changes to “DOLBY DIGITAL” automatically when Dolby Digital audio is inputted. However, “PROLOGIC” indication appears when Dolby Digital 2.0 is inputted. “STADIUM”, “ROCK ARENA”, and “JAZZ CLUB” are not selectable when Dolby Digital signal is inputted. (See pages 63-64)

DOLBY PRO LOGIC

Dolby Pro Logic provides four separate sound channels: front left, center, front right, and surround. For properly encoded programs marked the center sound channel contains the dialogue for the program viewed. The left and right channels produce sound effects that will match the action on the TV screen. For example, Dolby Pro Logic will enhance the effect of a car viewed driving from the left side of the TV screen to the right side. The surround channel (speakers) are placed behind the viewing area to add additional spatial sound effects.

To fully benefit from Dolby Pro Logic Surround, it is recommended that the surround speaker system be complete, as shown on page 16.

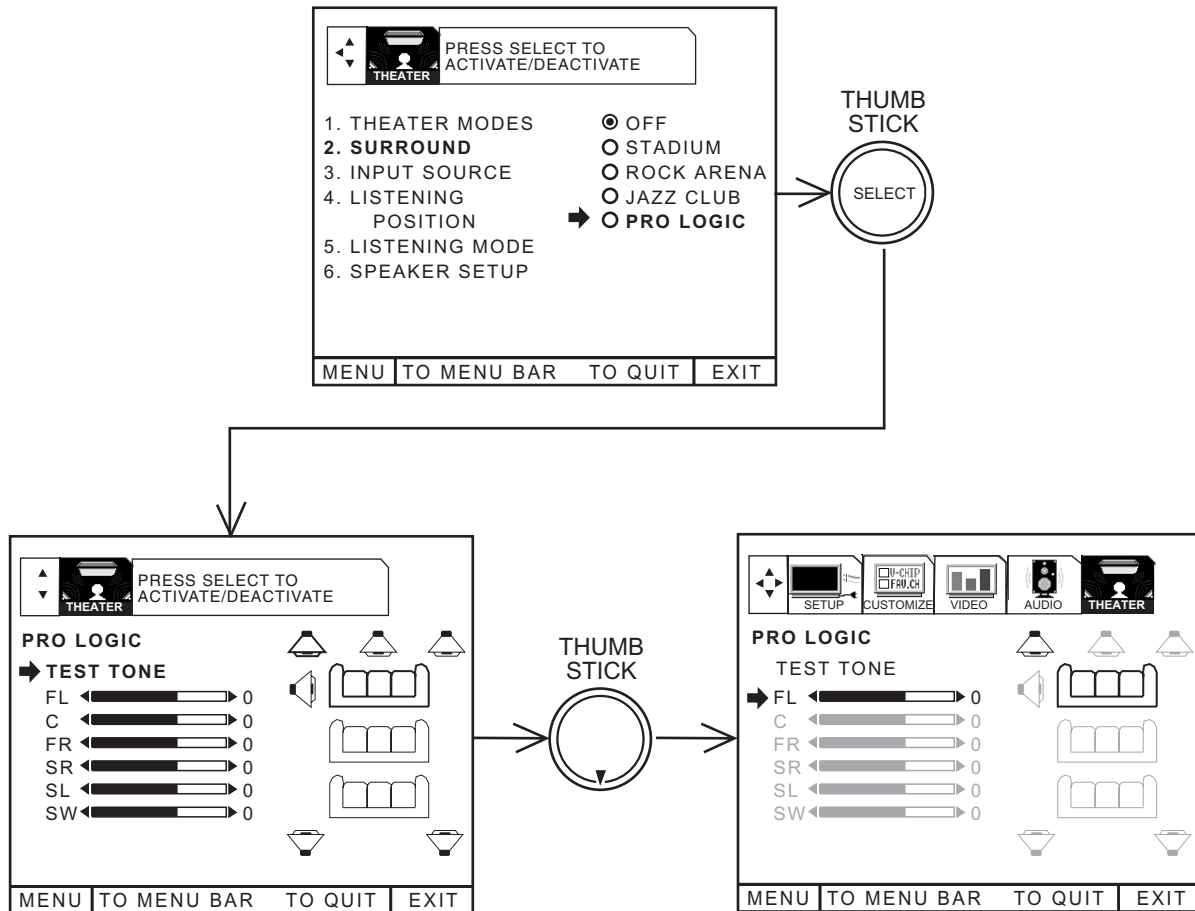

Press THUMB STICK ◀ or ▶ to change volume level of each speaker independently.

Press SELECT on THUMB STICK when TEST TONE is highlighted and TV will automatically cycle through all speakers. Simply wait until the speaker you wish to adjust is highlighted (static noise will be heard from this speaker), then use THUMB STICK ◀ or ▶ to adjust VOLUME. Using TEST TONE, you can quickly and easily set each speaker volume to a desired level.

Press ▼ on THUMB STICK when TEST TONE is highlighted to manually cycle through all speakers.

When main VOLUME is changed, all speaker volumes will change according to the percentages you set in this menu.

Set TV balance by adjusting FL (Front Left) and FR (Front Right) volume control.

NOTE: Center channel audio will always be heard from the TV's center speaker. If THEATER-SPEAKER SETUP-FRONT L/R is set to EXTERNAL W/AMP, center channel audio will still be heard from the TV's center speaker. Only the front Left and Right internal TV speakers can be turned off.



DOLBY DIGITAL

Dolby Digital provides six independent sound channels: front left, center, front right, surround left, surround right, and sub woofer. Select this feature when viewing properly encoded programs marked .

To fully benefit from Dolby Digital Surround, it is recommended that the surround speaker system be complete, as shown on page 16.

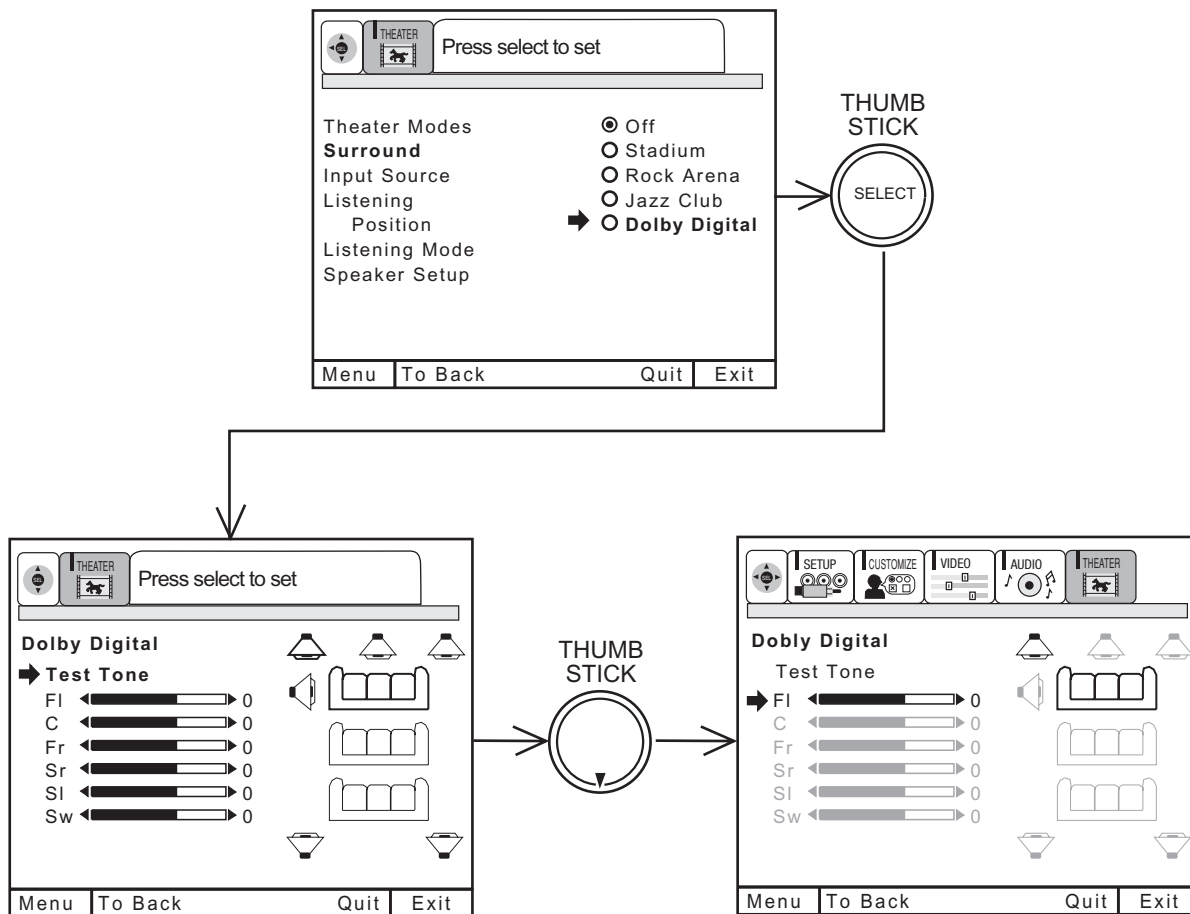

Press THUMB STICK ◀ or ▶ to change volume level of each speaker independently.

Press SELECT on THUMB STICK when TEST TONE is highlighted and TV will automatically cycle through all speakers. Simply wait until the speaker you wish to adjust is highlighted (static noise will be heard from this speaker), then use THUMB STICK ◀ or ▶ to adjust VOLUME. Using TEST TONE, you can quickly and easily set each speaker volume to a desired level. Press ▼ on THUMB STICK when TEST TONE is highlighted to manually cycle through all speakers.

When main VOLUME is changed, all speaker volumes will change according to the percentages you set in this menu.

Set TV balance by adjusting FL (Front Left) and FR (Front Right) volume control.

NOTE: Center channel audio will always be heard from the TV's center speaker. If THEATER-SPEAKER SETUP-FRONT L/R is set to EXTERNAL W/AMP, center channel audio will still be heard from the TV's center speaker. Only the front Left and Right internal TV speakers can be turned off.

THEATER



INPUT SOURCE

Set audio input to Digital or Analog. This feature is used only when viewing VIDEO:1 or VIDEO:2 inputs, since only these inputs can accept DIGITAL audio input.

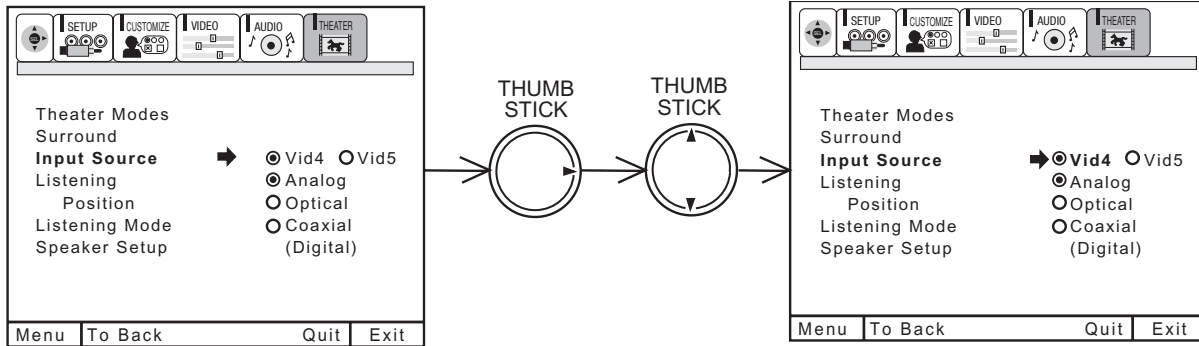

Use THUMB STICK ▲ or ▼ to select DIGITAL or ANALOG.

Press EXIT to quit menu or THUMB STICK ◀ to return to previous menu.

- NOTE:**
1. This feature selects between DIGITAL (Optical and Coaxial) Inputs on rear panel and ANALOG (Audio Left/Right) Inputs on rear panel.
 2. DIGITAL audio can only be used for VIDEO:1 or VIDEO:2 inputs. VIDEO:3 inputs can accept only ANALOG audio input.
 3. You cannot select COAXIAL for both VIDEO:1 and VIDEO:2 inputs. You also cannot select OPTICAL for both VIDEO:1 and VIDEO:2 inputs. You may only have 1 type of audio input for each rear panel input.

LISTENING POSITION

Set for optimum audio performance based on your listening position.

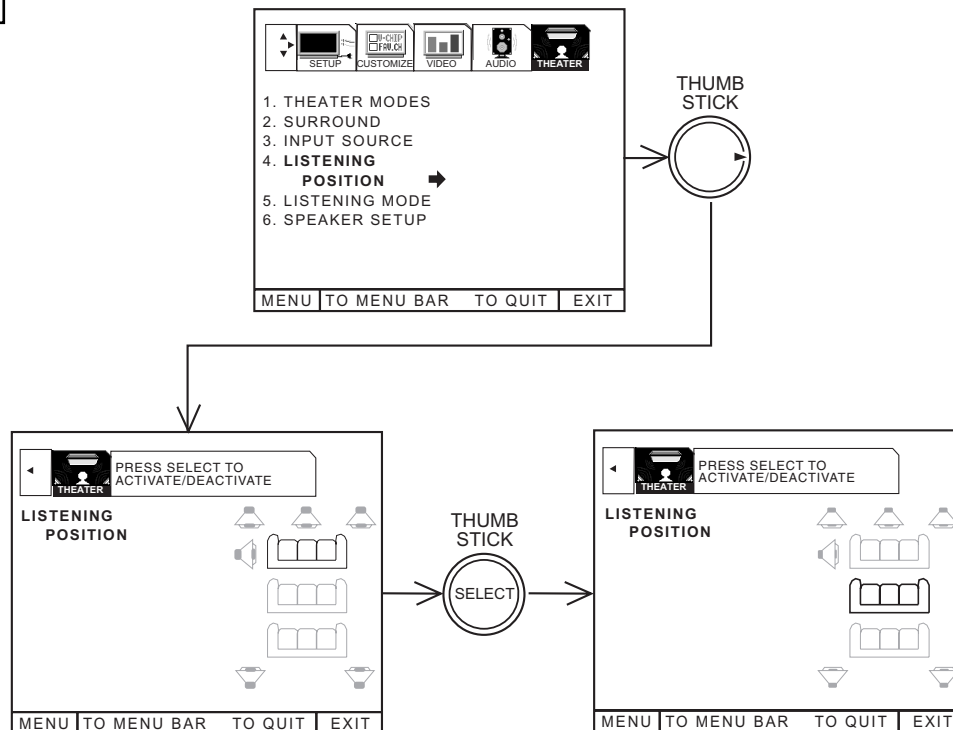

Press down on THUMB STICK to select Front, Center, or Rear LISTENING POSITION that matches your setup.

Press EXIT to quit menu or THUMB STICK ◀ to return to previous menu.

- NOTES:**
1. This feature adjusts audio delay to surround speakers to make audio performance optimum, based on your specific setup.
 2. This feature is only accessible when SURROUND-PRO LOGIC and SURROUND-DOLBY DIGITAL modes are selected.



LISTENING MODE

Choose between pre-set audio modes Standard, Night, or Maximum. Take advantage of these features to reduce or increase sound effects.

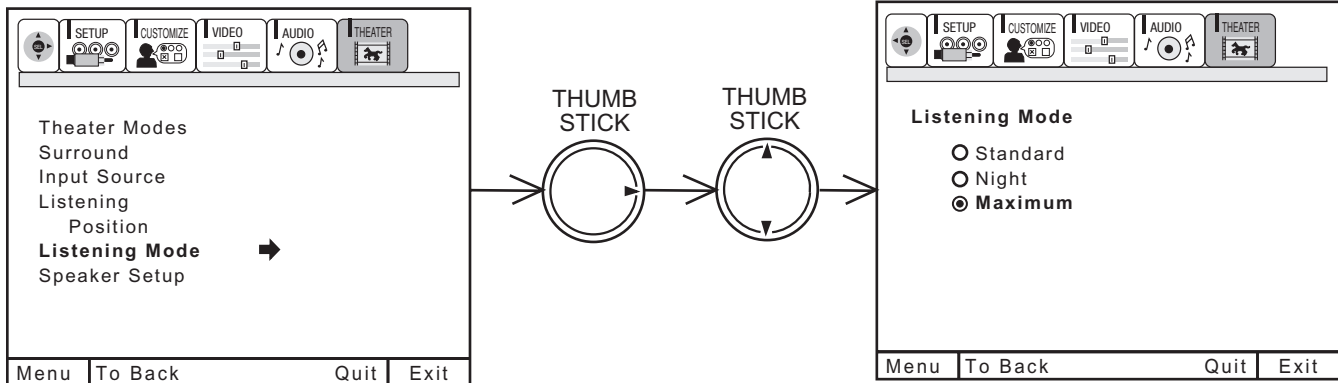

Use THUMB STICK ▲ or ▼ to select STANDARD, NIGHT, MAXIMUM.

Press EXIT to quit menu or THUMB STICK ◀ to return to previous menu.

When **STANDARD** is selected:

It is the normal listening mode. It does not make full use of your television's dynamic range, but is a good compromise for all day viewing/listening.

When **NIGHT** is selected:

This mode allows the audio to be reproduced in such a way that the impact of sound track extremes (such as explosions) are reduced while quiet passages are "boosted", allowing all the audio information to be heard at a low volume level. As its name suggests, this mode is intended for night time viewing.

When **MAXIMUM** is selected:

This mode makes the best use of the television's dynamic range. It will enhance the sound effects such as explosions or screams.

- NOTES:**
1. This feature is only accessible when SURROUND-DOLBY DIGITAL mode is selected and INPUT SOURCE-DIGITAL (Optical or Coaxial) is chosen.
 2. You must be in VIDEO:1 or VIDEO:2 to access this feature, since these are the only inputs which accept DOLBY DIGITAL inputs.

Available Digital Audio Formats:

Dolby Digital

PCM 32, 44.1, 48kHz (2 channels)

SPEAKER SETUP

Select specific speaker output, including a subwoofer.

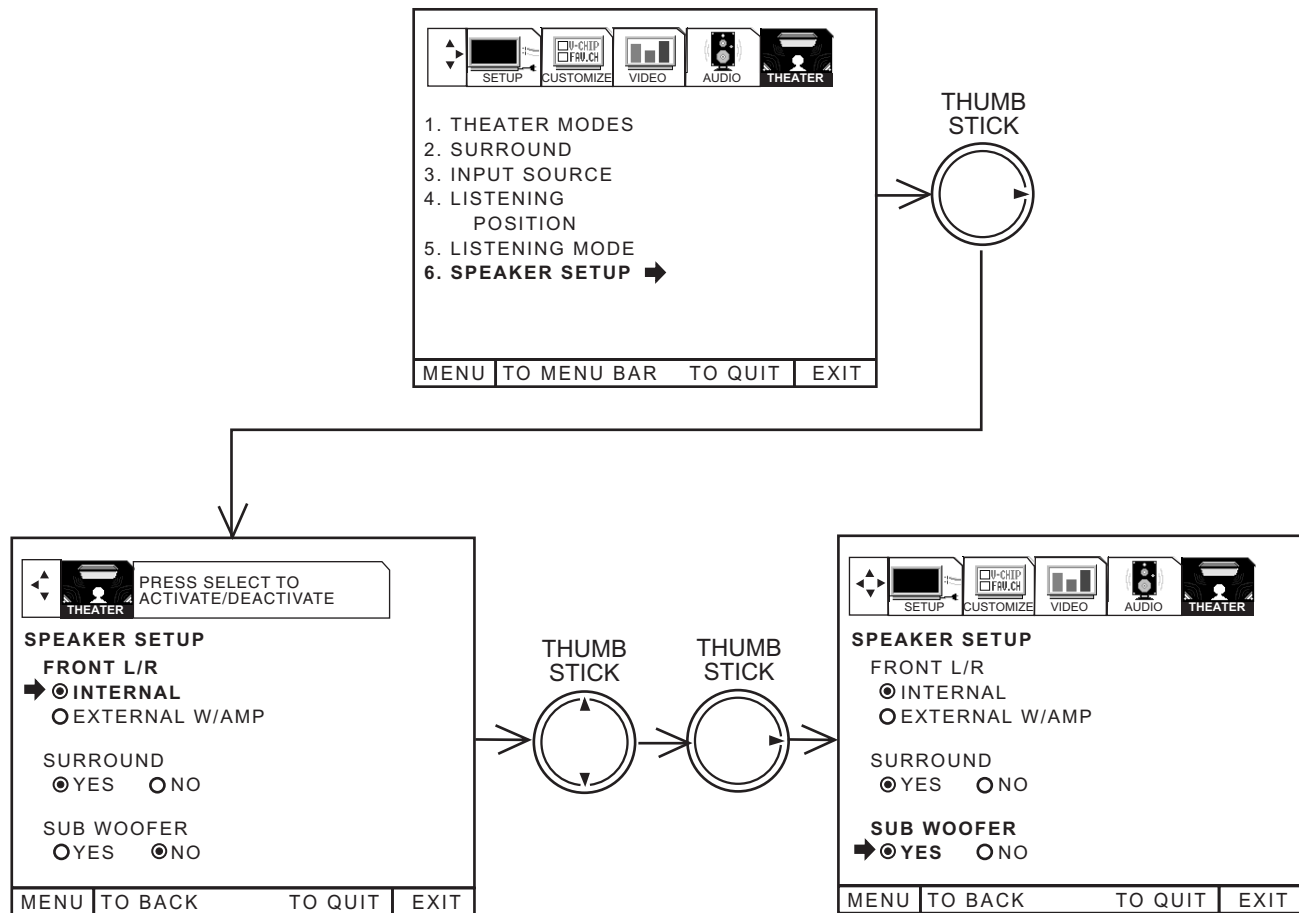

Press THUMB STICK ▲ or ▼ to highlight feature.
 Press down on THUMB STICK to select INTERNAL or EXTERNAL W/AMP.
 Use THUMB STICK ► to change SURROUND or SUB WOOFER feature to your desired setting.
 Press EXIT to quit menu or THUMB STICK ◀ to return to previous menu.

Select FRONT L/R - INTERNAL if you wish to use the TV internal Left and Right speakers.

Select FRONT L/R- EXTERNAL W/AMP if you wish to turn off the TV internal Left and Right speakers and use speakers connected to an external amplifier. This will provide better audio separation.

Select SURROUND - YES if you are using the TV speaker terminals (on rear panel) to power your surround speakers.

Select SURROUND - NO if you are not using the TV speaker terminals for your surround speakers or want to turn surround speakers OFF.

Select SUB WOOFER - YES if you have a sub woofer connected to the rear panel Sub Woofer jack. If you are not using this rear panel Sub Woofer jack or wish to turn OFF your SUB WOOFER, select SUB WOOFER - NO.

- NOTES:**
1. Surround speakers and Sub Woofer volume will increase and decrease when main volume is adjusted. Refer to THEATER-SURROUND menu on page 62 for instructions on how to set up your speakers.
 2. If SURROUND-NO, SUB WOOFER-NO are selected, when THEATER-SURROUND is chosen you will not be able to adjust volume level of SL, SR, or SW. This is because these speakers are turned OFF by selecting SURROUND-NO and SUB WOOFER-NO.

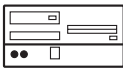

PC MODE CONNECTION AND OPERATION

IMPORTANT: TURN OFF THE REAR PROJECTION TV/PC MONITOR AND THE PC BEFORE CONNECTING OR DISCONNECTING ANY CABLES.

FRONT PANEL CONNECTION TO PC

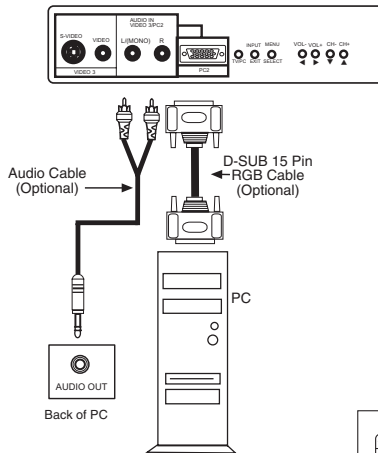

REAR PANEL CONNECTION TO PC

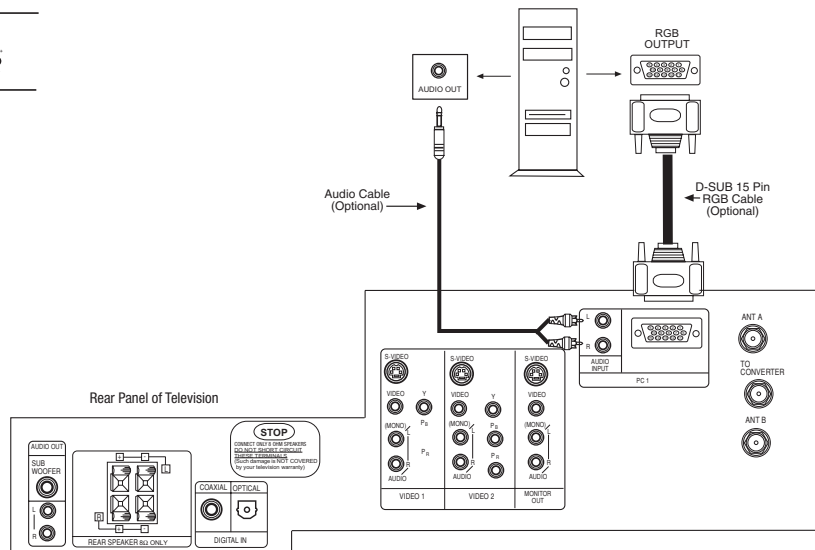

This PC ready Rear Projection Television can automatically detect and display PC signal format.

1. RGB input signal.

This PC ready Rear Projection Television can accept the following signal formats.

Preset Timings

No.	Formats			Horizontal Frequency	No.	Formats			Horizontal Frequency
1	VGA	640x400	70.1Hz	31.48kHz	13	XGA	1024x768	60.00Hz	48.36kHz
2	VGA	640x480	59.95Hz	31.48kHz	14	XGA	1024x768	70.07Hz	56.48kHz
3	Mac13	640x480	66.67Hz	35.00kHz	15	XGA	1024x768	75.03Hz	60.02kHz
4	VGA	640x480	72.81Hz	37.86kHz	16	Mac19	1024x768	74.93Hz	60.24kHz
5	VGA	640x480	75.00Hz	37.50kHz	17	XGA	1024x768	85.00Hz	68.68kHz
6	VGA	640x480	85.01Hz	43.27kHz	18	Mac21	1152x870	75.06Hz	68.68kHz
7	SVGA	800x600	56.25Hz	35.16kHz	19	SXGA	1280x1024	60.02Hz	63.98kHz
8	SVGA	800x600	60.32Hz	37.88kHz	20	SXGA	1280x1024	75.02Hz	79.98kHz
9	SVGA	800x600	72.19Hz	48.08kHz					
10	SVGA	800x600	75.00Hz	46.88kHz					
11	SVGA	800x600	85.06Hz	53.67kHz					
12	Mac16	832x624	74.55Hz	49.72kHz					

NOTE:

1. Dots correspond to the true resolution in Real Mode of aspect ratio, when you select signal of No. 1 to No. 12 on the table above. (One dot corresponds to one pixel).
2. The signal which resolution exceeds either 1280 dots or 720 lines may not display truly due to compression, then edges of the picture are slightly hidden.
3. Both vertical and horizontal picture in full mode and vertical picture in normal mode are overscanned.
4. We recommend you change either refresh rate or resolution setting of your video card at control panel from 60Hz to 70Hz, if you see noise on the picture with XGA 60Hz.
5. Always reset AUTO ADJUST feature when setting new display setting (VGA,SVGA,XGA) or when changing to a new computer.

PC MODE SPECIFICATION

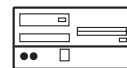

2. The new setting (horizontal position, vertical position, clock, and phase) of the signal will be stored. The monitor can store up to 10 settings in addition to the 20 pre-set signal timing. Any additional new settings (more than 10) will over-write the first user's setting, second setting and so on.
3. Operation PC mode related to TV functions are shown below.

No.	Item	Operation
1	Event Program	Only power on is available
2	Commercial Skip	Not available.
3	Video Control	Contrast and brightness work separately, however, other picture controls are not available.
4	Audio	Same as Video 3.
5	Audio-Balance	Balance does not work in PC mode if surround setting is not OFF.
6	Surround Mode	Same as Video 3.
7	Mute / Soft Mute	Same as TV mode.
8	Closed Caption	Not available.
9	Clock	Clock indication is not available.
10	Sleep Timer	Only one minute remaining indication.
11	Monitor Out	Both picture and audio are not available.
12	Child Lock / Video Lock / V-Chip	Not available.
13	TV Time Out	Not available.
14	Front Panel Lock	Available.
15	Menu Language	Three languages are available.
16	Auto Link	Turning back to TV mode in operation, then power on.
17	Menu Background	Not available.

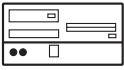

PC ON SCREEN DISPLAY

- Other signal formats may not be displayed correctly. Use AUTO ADJUST to automatically adjust the horizontal position, vertical position, clock, and phase. We recommend you use signal, which has more than 50% of amplitude of white area at each corner of the picture, execute Auto adjustment. It may not work correctly with dark picture. (See page 73-74).
- Input signal level.

SYNC	TTL level H/V separate signal
RGB	0.7Vpp

NOTE: Interlaced signal is not available.

- PC picture will not appear at all when receiving a signal which is not supported by this product. If PC display setting is wrong, the monitor will display:

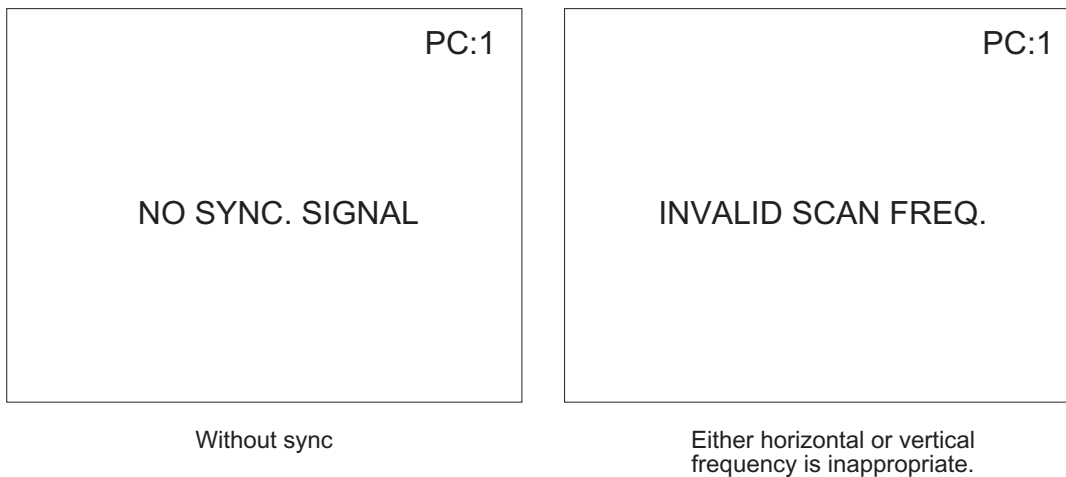

- NOTE:**
- If PC cannot display an input signal, please try AUTO ADJUST to display the signal. This is to initialize the MultiScan Converter.
 - If PC is set to correct horizontal and vertical frequencies and the picture is out of sync or scrambled, check the video card documentation and set up software to properly set the monitor.

PC MODE CONNECTION AND OPERATION

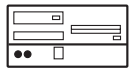

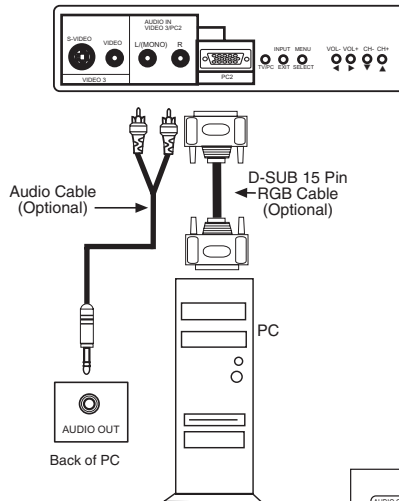

IMPORTANT: TURN POWER OFF ON THE DLP™ REAR PROJECTION TELEVISION AND THE PC BEFORE CONNECTING OR DISCONNECTING ANY CABLES.

FRONT PANEL CONNECTION TO PC

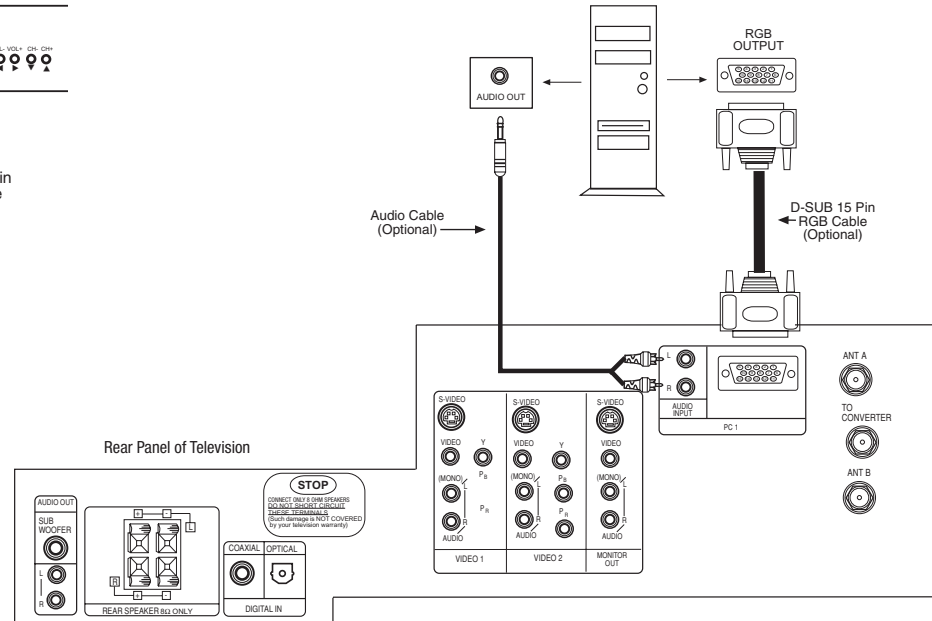

REAR PANEL CONNECTION TO PC



2. Turn the DLP™ Rear Projection TV/PC monitor power on.
3. Press the TV/PC button on the front panel or on the remote control until you select PC mode.
4. Turn the PC power on.
5. Press the menu button on the DLP™ Rear Projection TV/PC monitor front panel or on the remote control to display the PC on screen display.
6. Press the left (◀) or right (▶) cursor buttons to select the audio menu .
7. Press the select buttons to access the audio adjustment functions.
8. Use cursor and select button to adjust equalizer, loudness, and dynamic bass to your preference.

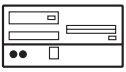

PC ON SCREEN DISPLAY

1. Press MENU on the remote control to display the different features in PC MODE.
2. Press the CURSOR buttons to highlight a different feature.
3. Press EXIT on the remote control to quickly exit from a menu.

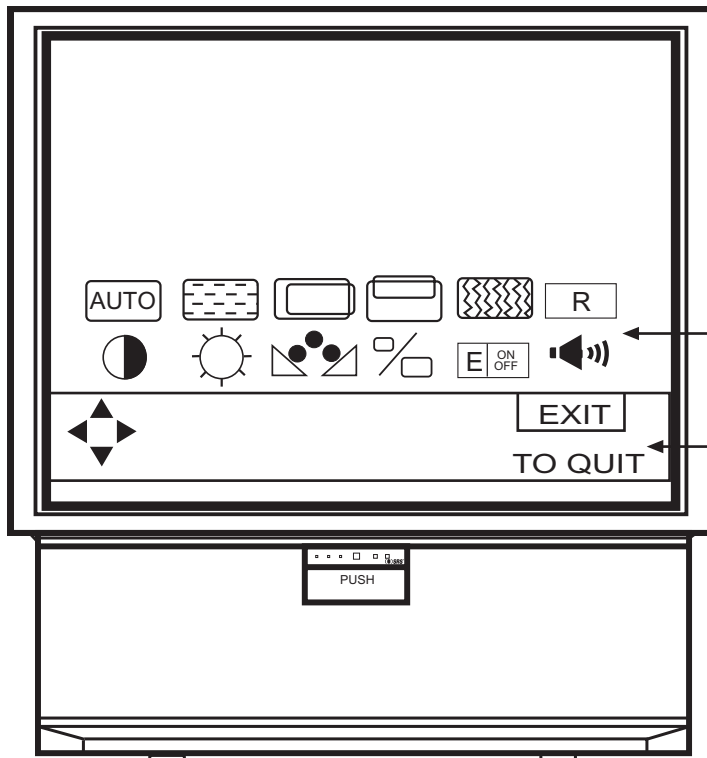
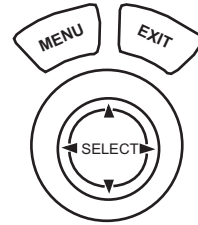

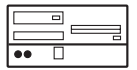

This part of the screen shows what selections are available.

This part of the screen shows which remote control buttons to use.

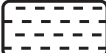

 →  Automatically adjust the geometry to fit the screen.



 →  Adjust the phase to correct blurred or unstable images.

 →  Adjust horizontal position.

 →  Adjust vertical position.

 →  Adjust the dot clock frequency to reduce the vertical stripe.

 →  Recall the factory preset data of PC settings.

 →  Change the contrast between black and white levels in the picture.

 →  Adjust overall picture brightness.

 →  Balance between Red and Blue color.

 →  Increase the horizontal size and vertical size.

 →  Enhance picture details.

 →  Enhance audio quality.

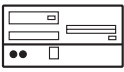

PC ON SCREEN DISPLAY

SET UP ADJUSTMENTS

The following adjustments are independent of the TV mode:

- Press MENU in PC mode for on screen display.
- Press CURSORS to highlight the item to be adjusted.
- Press SELECT to select the highlighted item.
- Use CURSORS and SELECT to adjust.

AUTO

AUTO ADJUST

HORIZONTAL POSITION, VERTICAL POSITION, CLOCK and PHASE for current PC format are adjusted automatically.

Press SELECT to select AUTO ADJUST.

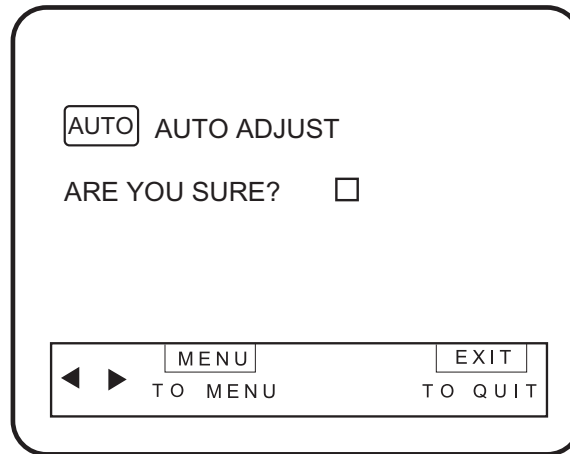

NOTE: Always reset AUTO ADJUST when setting new display setting (VGA, SVGA, XGA) or when changing to a new computer.



PHASE

Adjusts the phase to correct blurred or unstable images. Phase of sampling clock of Multi-Scan Converter unit is changed when pressing CURSOR (◀) left or right (▶) button.

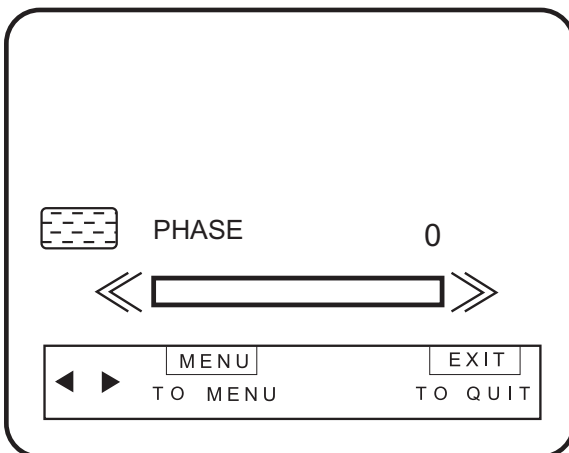

Use Left/Right cursors to adjust the phase. Press the MENU button to return to initial position of menu icon and EXIT to quit.

- NOTE:**
- Press SELECT to AUTO ADJUST the PC mode.
 - The other functions do not operate while automatic adjustment is in progress.
 - Proceed to automatic adjustment after more than 20 minutes have passed since the power is ON.
 - Select a bright image for display while automatic adjustment takes place.
 - If automatic adjustment terminates unsuccessfully, try automatic adjustment again. If automatic adjustment fails several times in succession, try using manual adjustment.

PC ON SCREEN DISPLAY

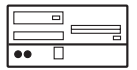

H POSITION

This feature allows you to adjust the horizontal position of the display.

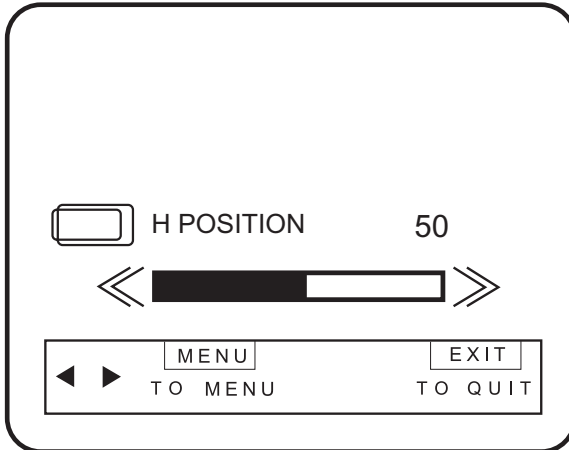

Use Left/Right cursors to adjust the horizontal position. Press the MENU button to return to initial position of menu icon and EXIT to quit.



V POSITION

This feature allows you to adjust the vertical position in PC mode.

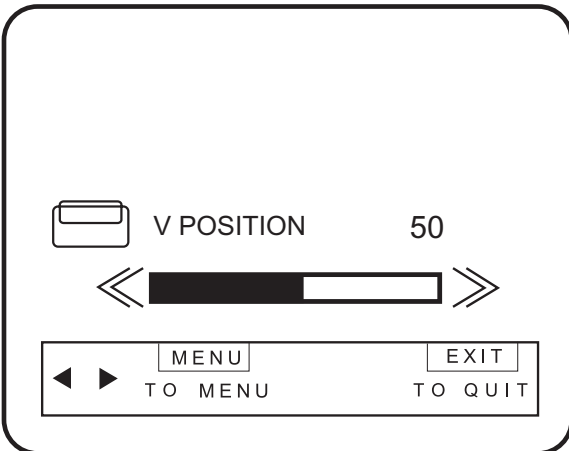

Use Left/Right cursors to adjust the vertical position. Press MENU button to return to initial position of menu icon and EXIT to quit.



CLOCK

Adjusts the dot clock frequency to reduce the vertical stripe. Sampling clock of Mult-Scan Converter unit is changed when pressing CURSOR LEFT (◀) or CURSOR RIGHT (▶) buttons.

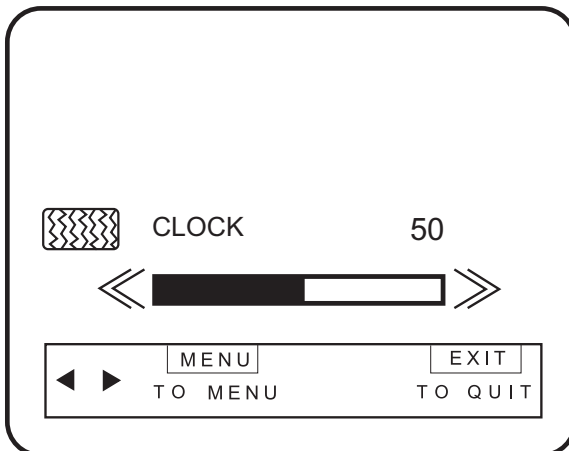

Use Left/Right cursors to adjust the clock. Press the MENU button to return to initial position of menu icon and EXIT to quit.

- NOTE:**
1. Due to varying signal content, you may see vertical or horizontal lines bend occasionally in PC mode. However, this phenomenon is not a defect. It's caused by a lack of picture content due to under-scanning in PC mode.
 2. This set provides the best picture quality in SVGA mode. It is recommended that you set your PC to SVGA mode. In OVERSCAN mode, top/bottom icon will be approximately 19% to 50% within the viewable area, and should be accessible to grab and click. Picture is overscanned when receiving XGA or higher resolution.

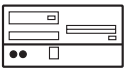

PC ON SCREEN DISPLAY

R

DATA RECALL

Set HORIZONTAL POSITION, VERTICAL POSITION, CLOCK and PHASE to factory preset, for current PC format.

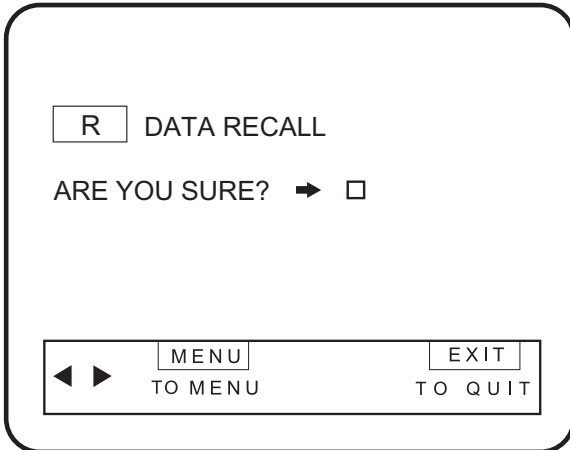

Press THUMB STICK ► to select DATA RECALL.



CONTRAST

This feature allows you to adjust the contrast in PC mode.

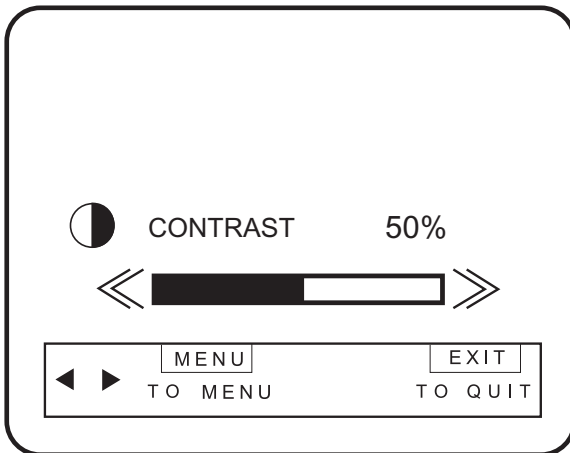

Use Left/Right cursors to adjust contrast. Press MENU button to return to initial position of menu icon and EXIT to quit.

NOTE: See TV contrast feature for additional information regarding contrast.



BRIGHTNESS

This feature allows you to adjust brightness in PC Mode.

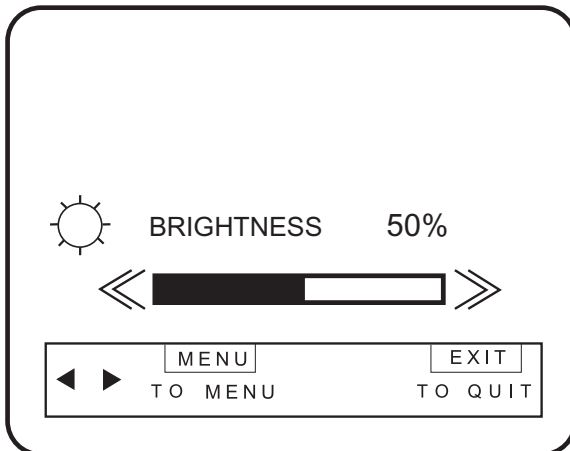

Use Left/Right cursors to adjust brightness. Press MENU button to return to initial position of menu icon and EXIT to quit.

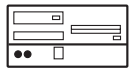

COLOR BALANCE

Use the CURSOR to change the COLOR BALANCE of red, green and blue.

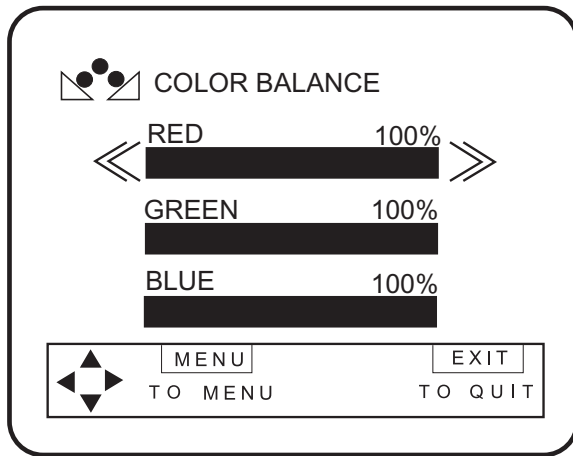

THUMB
STICK

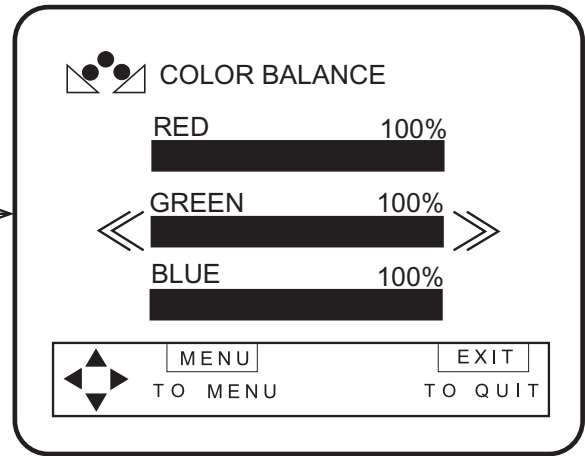
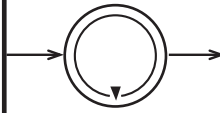

EXPANSION

The picture size is expanded when switching from REAL, NORMAL and FULL. REAL feature is not available on XGA or SXGA mode.

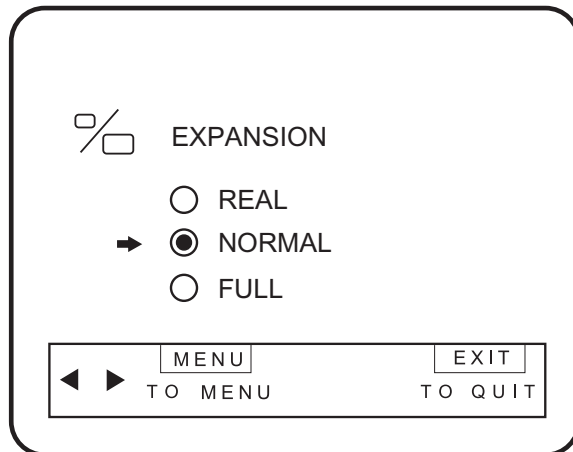

- Use Left/Right cursors to set EXPANSION ON or OFF.
- Press MENU button to store and EXIT to quit.



ENHANCE

Enhances the picture detail.

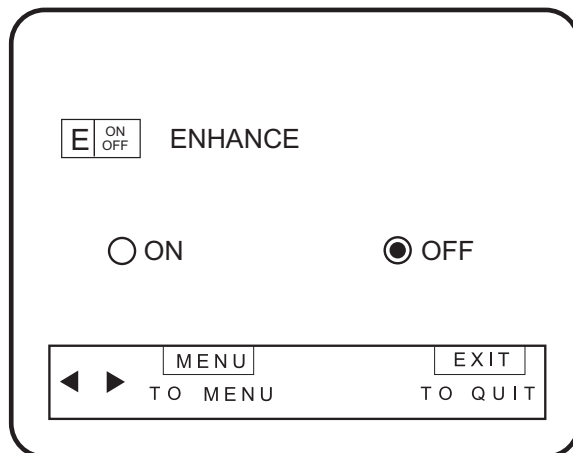

- Use Left/Right cursors to set ENHANCE ON or OFF.
- Press MENU button to MENU and EXIT to quit.

NOTE: This function can be used when inputted signal resolution is either equal to or less than SVGA with FULL or NORMAL mode. Enhance may have no effect or picture quality may be worse when XGA or higher resolution signal is inputted or Real mode is selected.

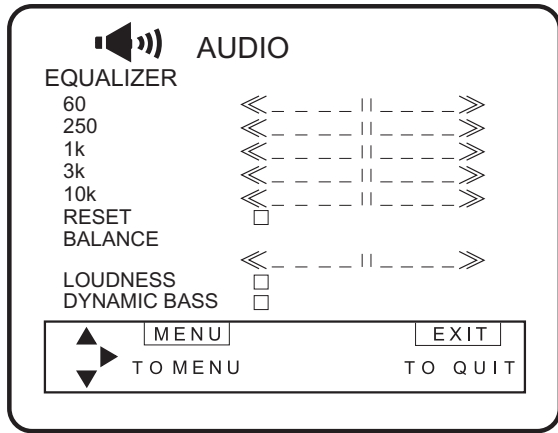
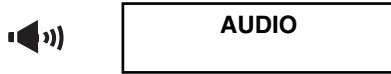
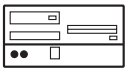

Use the CURSOR ▲ or ▼ to highlight the function to be adjusted.

Press CURSOR ◀ or ▶ to adjust the function.

Press MENU button to store and EXIT to quit.

EQUALIZER

This function controls the low audio frequency and high audio frequency between 60 Hz to 10k Hz.

RESET

When RESET is selected, the “ARE YOU SURE?” display will appear on the screen to confirm your choice. Press SELECT to return AUDIO adjustments to factory preset conditions.

BALANCE

This function will control the left to right balance of the TV internal speakers and the AUDIO TO HI FI output.

Press CURSOR ▼ for more AUDIO ADJUSTMENT.

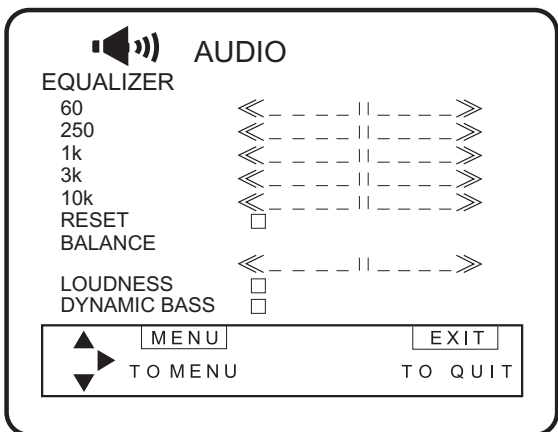

Use CURSOR ▲ or ▼, then press SELECT to select DYNAMIC BASS on or off.

Press MENU button to store and EXIT to quit.

NOTE: TV mode and PC mode AUDIO have the same effect. BALANCE works if surround is set to OFF in TV/VCR mode.

LAMP REPLACEMENT



Lamp Replacement

After extended use, if the TV picture turns dark, the color looks unusual or LAMP INDICATOR light turns on, then it is time to replace the lamp with a new lamp. Lamp should be replaced after 4,000 hours of use.

WARNING:

The lamp gets very hot! The lamp may explode if improperly handled. To avoid injury, please observe the following precautions.

- Do not open lamp compartment or attempt to remove lamp assembly unless the lamp assembly is being replaced.
- Unplug the product's power cord from the AC outlet before attempting to replace the lamp assembly.
- If the lamp is in use when failure occurs or if the lamp has exploded, wait at least 30-45 minutes for the lamp to cool before opening the lamp compartment or touching the lamp assembly or any broken pieces.
- Broken lamp pieces can cause injury. Handle with gloves to avoid cuts.
- Do not place any foreign objects inside the lamp compartment.
- When installing a new lamp, follow handling instruction included with the new lamp. Do not touch glass surface of new lamp.
- Please dispose of old lamp assembly properly.

CAUTION!

A "LAMP" indicator will light when lamp becomes hot. Unplug product's power cord from the AC outlet and allow lamp to cool for at least 30-45 minutes. If "LAMP" indicator is still lit, please contact your authorized service center. (see page 7)

NOTES:

- Contact your Marantz dealer for a new lamp unit. Using other lamps may cause damage to the TV Set.

TYPE NAME: DLP™ LAMP ASSEMBLY

PART NUMBER: DP00402

- When replacing the lamp, let it cool down completely, for approximately 30 to 45 minutes after the power has been switched off and A.C. cord has been unplugged.
- Do not touch the glass of the new lamp or make it dirty which can shorten the life of the lamp and ruin the picture quality.
- Keep the lamp out of the reach of children and away from flammable materials.
- Do not pour water onto the removed lamp or put any object inside the lamp.
- Once the lamp is removed, do not put flammable materials and metal objects inside the lamp receptacle on the TV set. Do not touch the receptacle.
- Install the new lamp securely, otherwise the picture may become dark or it may cause severe overheating and possible fire.
- Install the lamp cover correctly, otherwise power will not come on.
- When you have finished changing the lamp, remember to reset the LAMP TIME COUNTER. (See page 48 to reset the LAMP TIME COUNTER.)
- LAMP MUST BE DISPOSED OF PROPERLY. FOR ASSISTANCE, PLEASE CALL 1-800-654-6633



LAMP REPLACEMENT

1. Turn off the main power switch on the front panel and unplug the power cord from the wall outlet.

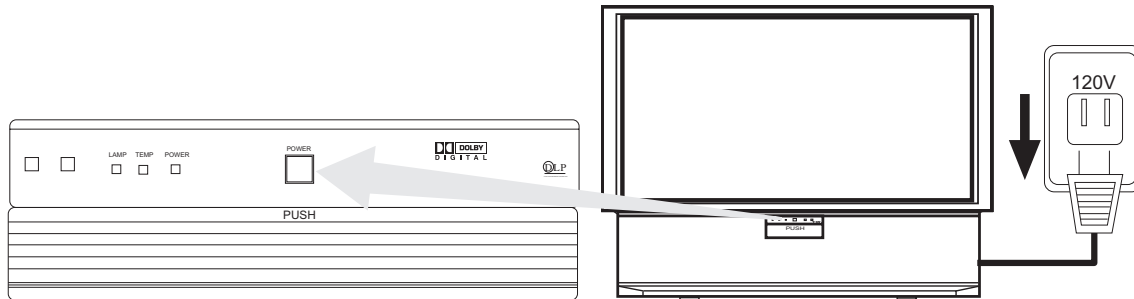

CAUTION: THE LAMP IS VERY HOT AND MAY CAUSE FIRE OR SEVERE BURNS. WAIT AT LEAST 30 MINUTES TO ALLOW THE LAMP TO COOL BEFORE PROCEEDING WITH LAMP REMOVAL.

2. Loosen the screw that secures the lamp cover with a Phillips Head Screw Driver. Release the two clips on the left side of lamp cover. Remove the lamp cover by pulling it toward you and to the right.

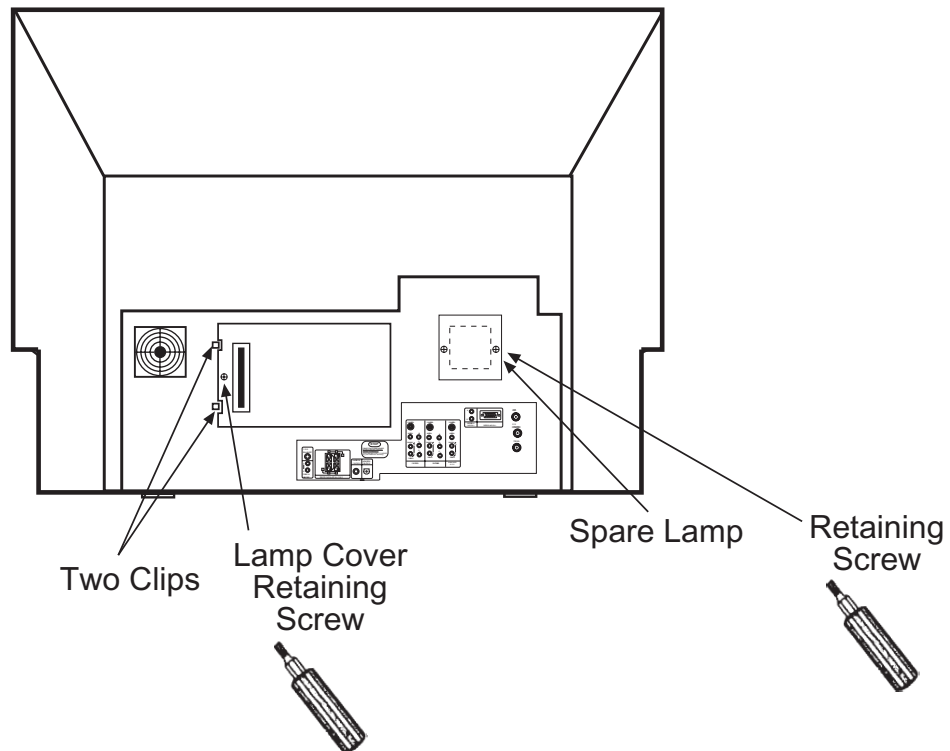

LAMP REPLACEMENT



- Loosen the two screws securing the latch cover with a Phillips Head Screw Driver as shown. If these screws are not loosened completely, the lamp unit cannot be removed.

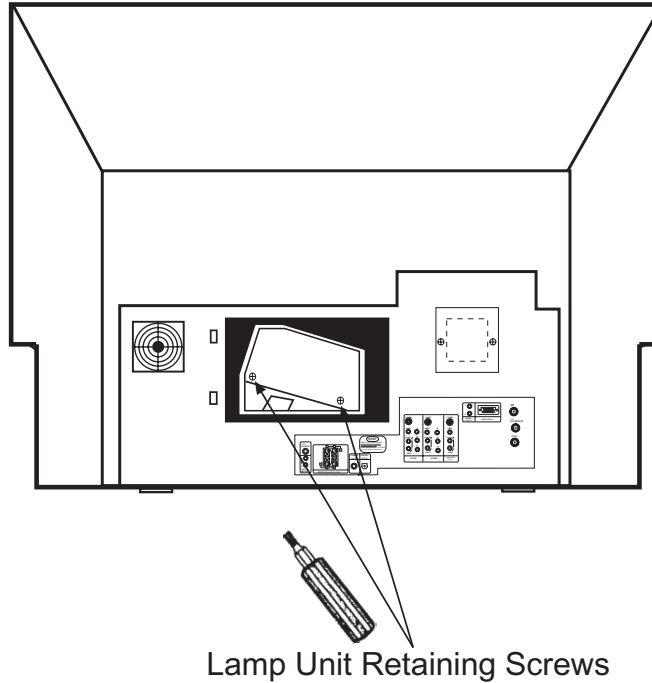

CAUTION: THE LAMP IS VERY HOT AND MAY CAUSE FIRE OR SEVERE BURNS. AFTER UNPLUGGING THE POWER CORD, WAIT AT LEAST 30 MINUTES UNTIL THE LAMP IS COOL BEFORE ATTEMPTING TO REMOVE.

- Remove the lamp unit by holding the lamp handle, then pulling outwards. Exercise caution when removing the lamp unit to avoid injury to your fingers. If the lamp unit does not come out easily, check to make sure the screws in step 3 are loosened completely.

WARNING: DO NOT PUT YOUR HAND IN THE LAMP STORAGE AREA AFTER THE LAMP UNIT IS REMOVED, YOU MAY GET BURNED.

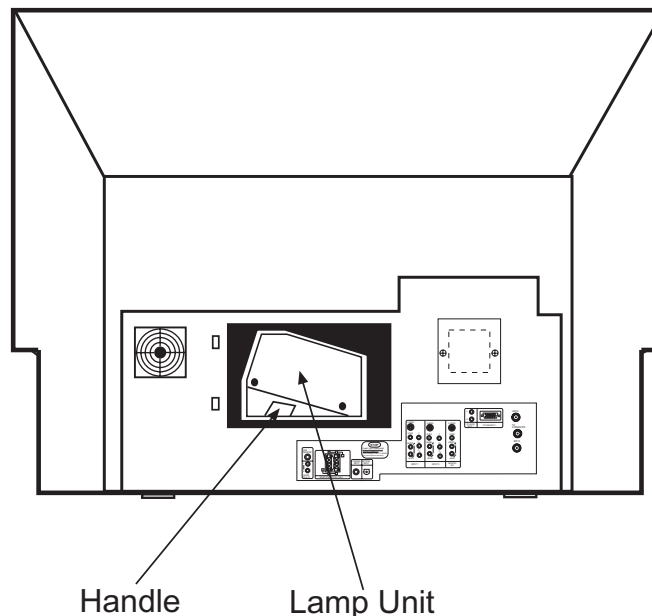



LAMP REPLACEMENT

- Remove the two screws securing the spare lamp unit. Remove the spare lamp unit. Replace the spare lamp cover.
- Replace the lamp.
 - ¥ Push the lamp unit back to its original position.
 - ¥ Tighten the screws firmly on the lamp unit. If they are loose, the TV may not operate correctly.

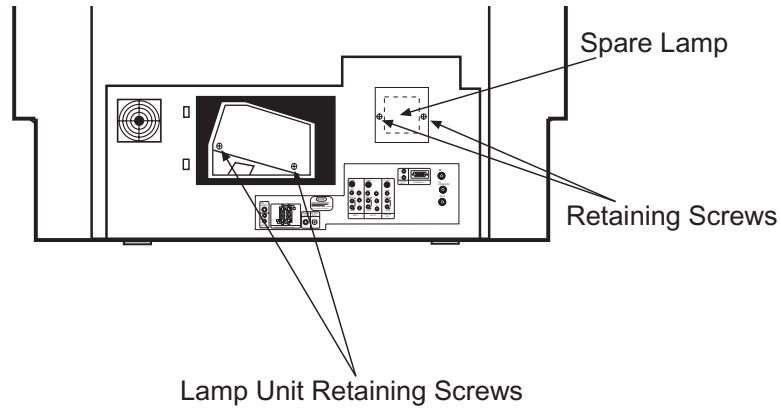

- Reinstall the lamp cover by re-engaging the two clips and installing the screw removed in Step 2. Be sure to install the lamp cover securely and tighten the screw before turning the power on, otherwise it may cause unusual colors.

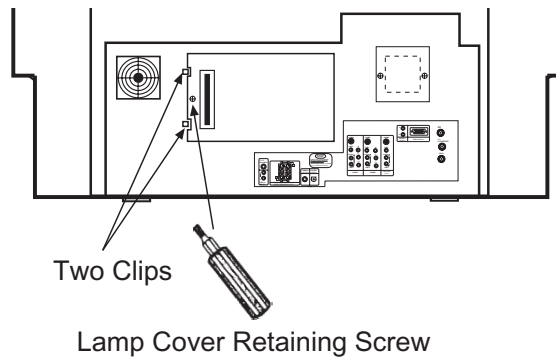

CAUTION: IF POWER IS CONNECTED BEFORE THE LAMP COVER IS INSTALLED, THE POWER WILL BE OFF AND THE LAMP INDICATOR WILL FLASH (See page 7).

- Plug power cord into AC outlet and turn on the main power switch.

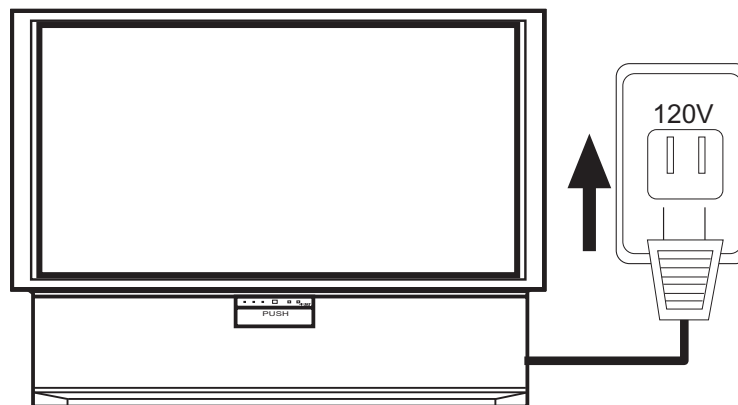

NOTES: 1. After installing the new lamp, don't forget to reset the LAMP TIME COUNTER. (see page 48)
2. The old lamp must be disposed of properly. For assistance, please call 1-800-654-6633.

PLUG and PLAY

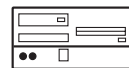

This DLP™ Rear Projection TV complies with VESA DDC2B specifications, Plug & Play is a system with computer, peripherals (including monitors) and operating system. It works when the monitor is connected to a DDC ready computer that is running an operating system software that is capable for the plug & play.



When a Plug and Play PC is powered on, it sends a command to the Monitor requesting identification. The Monitor sends back a string of data including its characteristics.

TRADEMARK ACKNOWLEDGMENT

DDC™ is a trademark of Video Electronics Standard Association.

IBM PC/AT and VGA are registered trademarks of International Business Machines Corporation of the U.S.A.

Apple and Macintosh are registered trademarks of Apple Computer, Inc.

VESA is a trademark of a nonprofit organization, Video Electronics Standard Association.



This Class B digital apparatus meets all requirements of the Canadian Interference-Causing Equipment Regulations.

This Class B digital apparatus complies with Canadian ICES-003.

Cet appareil numérique de la classe B à la norme NMB-003 du Canada.

Cable Compatible Television Apparatus- Télévision câblocompatible, Canada.

Notes on Closed Caption:

This television receiver will display television closed captioning, ( or ), in accordance with paragraph 15.119 of the FCC rules.



AGENCY REGULATORY INFORMATION

Federal Communications Commission Notice

This equipment has been tested and found to comply with the limits for a Class B digital device, pursuant to Part 15 of the FCC Rules. These limits are designed to provide reasonable protection against harmful interference in a residential installation. This equipment generates, uses and can radiate radio frequency energy and if not installed and used in accordance with the instructions, may cause harmful interference to radio communications. However, there is no guarantee that interference will not occur in a particular installation. If this equipment does cause harmful interference to radio or television reception, which can be determined by turning the equipment off and on, the user is encouraged to try to correct the interference by one or more of the following measures:

- Reorient or relocate the receiving antenna.
- Increase the separation between the equipment and the receiver.
- Connect the equipment into an outlet on a circuit different from that to which the receiver is connected.
- Consult the dealer or an experienced radio/television technician for help.

Modifications

The FCC requires the user to be notified that any changes or modifications made to this device that are not expressly approved by Marantz America may void the user's warranty.

Cables

Connections to this device must be made with shielded cables with metallic RFI/EMI connector hoods to maintain compliance with FCC Rules and Regulations.

Any cables that are supplied with the system must be replaced with identical cables in order to assure compliance with FCC rules. Order Marantz spares as replacement cables.

Declaration of Conformity

This device complies with Part 15 of the FCC Rules. Operation is subject to the following two conditions: (1) this device may not cause harmful interference and (2) this device must accept any interference received, including interference that may cause undesired operation.

Any cables that are supplied with the system must be replaced with identical cables in order to assure compliance with FCC rules. Order Marantz spares as replacement cables.

For questions regarding this declaration, contact:

Marantz America
1100 Maplewood Drive
Itasca, IL 60143
Tel. No.: 1-800-654-6633



DO

Dust the screen and cabinet with a soft cloth.

Clean the screen with a soft cloth moistened in warm water and dry with a soft cloth. A mild soap may be used if the screen is extremely dirty.

Place your television away from extreme heat, humidity and extremely dusty places.

Remove the plug from the wall outlet if your television will not be used for a long period of time, for instances, when you go on vacation.

DO NOT

Do not clean your screen or cabinet with strong cleaners, polishes or a chemically treated cloth.

Do not place rubber or vinyl products or cellophane tape on your television.

Do not touch the screen too often.

Do not subject the remote control to shocks such as dropping it on the floor, etc. Physical damage to the precision parts may result.

Avoid placing the remote control in a high humidity place or getting it wet. Do not leave it on or near a heater. Excessive heat or moisture may cause the unit to cease operation.

When the batteries run down, remote control operation will become erratic or possibly stop altogether. Replace the old batteries with two new "AA" size batteries.

Exposure of the viewing screen to prolonged direct sunlight or heat may cause the screen to permanently warp, resulting in a distorted picture.



SYMPTOMS	CHECK THESE ITEMS AND TRY THESE ADJUSTMENTS											
	Be sure external connection is correct	Be sure power cord is plugged in	Be sure Rear Projection TV is switched ON	Try another channel (station trouble)	Check antenna connections (back of Rear Projection TV.)	Check antenna for broken lead-in wire	Check outside antenna	Adjust Contrast control	Adjust Brightness control	Adjust Color control	Adjust Tint control	Adjust Volume control
No picture, no sound	●	●	●	●	●	●	●					
Sound OK, picture poor	●			●	●	●	●	●	●			
Picture OK, sound poor	●			●	●	●	●	●				●
Picture blurred	●			●	●	●	●	●				
Lines or streaks in picture				●	●	●	●	●				
Poor reception on some channels				●	●	●	●	●				
No color	●			●	●	●	●			●		
Poor color	●			●	●	●	●			●	●	

This Rear Projection Television incorporates advanced power surge protection technology designed to protect against component or circuit damage due to internal voltage or power surges.





IF YOUR SET SHOULD APPEAR TO HAVE A LOSS OF POWER, PLEASE FOLLOW THIS PROCEDURE:

- 1) Press the power switch (ON/OFF switch) once.
- 2) If there is still no power, wait 30 seconds and press the power switch again.
- 3) If there is still no power, unplug the power cord from the wall. Wait thirty seconds and plug the power cord back in. Press the power switch again.

This protective technology should provide for years of lasting entertainment from your MARANTZ Rear Projection Television.

CARE OF YOUR MARANTZ PROJECTION TV



	<ul style="list-style-type: none">• IGNITION NOISE: Black spots or horizontal streaks may appear, picture may flutter or drift. Usually caused by interference from automobile ignition systems, neon lamps, electrical drills and other electrical appliances.
	<ul style="list-style-type: none">• GHOSTS: Ghosts are caused by the Rear Projection Television signal following two paths. One is the direct path and the other is reflected from tall buildings, hills or some other objects. Changing the direction or position of the antenna may improve reception. Ghosting may also be caused by defects in the antenna system such as unshielded leads or connecting several sets to the same antenna without using multiple antenna couplers.
	<ul style="list-style-type: none">• SNOW: If your receiver is located in the fringe area of a television station where the signal is weak, your picture may be marred by the appearance of small dots. When the signal is extremely weak, it may be necessary to install a special antenna to improve the picture.
	<ul style="list-style-type: none">• RADIO FREQUENCY INTERFERENCE: The interference produces moving ripples or diagonal streaks and in some cases, causes loss of contrast in the picture.

NOTE: The Rear Projection Television can generate sound distortion in external devices such as a radio. Please separate radio equipment from the Rear Projection Television to a considerable distance.

NOTE: The Rear Projection Television has the nature that some pixels do not always work correctly. That is, some are lit and some are not. This is not a problem.

SCREEN

The screen surface is easily scratched. Do not rub, touch or tap it with sharp or abrasive objects. Be especially careful when transporting the Rear Projection Television.

PANEL

Do not expose the screen to direct sunlight. It may damage the panel. When the Rear Projection Television is used in a cold place, the image may look lengthened. This is not a malfunction. The image will become normal when the temperature rises.

When the same static picture has been displayed continuously, an afterimage impression of that picture may remain on the screen. This will disappear after a certain period of time.

If you turn on the Rear Projection Television immediately after power has been restored at an interruption, burn may occur. This is not a malfunction. The image will become normal after a certain period of time.

MOISTURE CONDENSATION

If the Rear Projection Television is transported directly from a cold to a warm location or if the room temperature has changed suddenly, the picture may be blurred or show poor color. This is because moisture has condensed on the lenses inside. If this happens, let the moisture evaporate before using the Rear Projection Television.



Features:

- Superfine Picture Quality with Digital Light Processing™ Technology.
- Digital Micromirror Device™ System
 - * Digital Light Processing, DLP, Digital Micromirror Device and DMD are trademarks of Texas Instruments.
- 16:9 Aspect Ratio, 1280 x 720 Resolution
- HDTV compatible (1080i, 720P, 480P, 480i)
- PC input: XGA Compatible (XGA: Compressed, SVGA/VGA: Real)
- Perfect Picture System
- Remote (controls many VCR brands, cable box, satellite boxes and other audio equipment.)
- High Definitions On Screen Display
- 2-Tuner Picture in Picture (Single, Split-Screen and Surf 3)
- Full Set of Input Jacks, including S-VIDEO
- COMPONENT: Y-C_B/C_R and Y-P_B/P_R Input Jacks
- 2 sets of PC input D-Sub Mini 15 pin connector
- Closed Caption Decoder
- Parental Control
- Dual Antenna inputs
- Digital 3 Dimensional Y/C Comb Filter (3DYC)
- All time progressive scanning with Multi-Scan Converter Technology
- Dolby Digital, Dolby Pro Logic, Stadium, Rock Arena, Jazz Club Surround Sound
 - * Manufactured under license from Dolby Laboratories. “Dolby”, “Pro Logic” and the double-D symbol are trademarks of Dolby Laboratories. Confidential Unpublished Works. ©1992-1997 Dolby Laboratories, Inc. All rights reserved.

Inputs:

- Power InputAC 120V, 60Hz
- Power Consumption (operating)
DL5500360W
- Power Consumption (maximum)
DL5500440W
- Antenna input impedance75 Ohm
- Channel coverage181ch.
VHF-Band2 ~ 13
UHF-Band14 ~ 69
CATV Mid BandA-5 ~ A-1
.A-I
Super BandJ-W
Hyper BandW+1 - W+28
Ultra BandW+29 - W+84
- Video1.0Vp-p, 75 Ohm
- S-VIDEO
Luminance (Y)1.0Vp-p, 75 Ohm
Chrominance (C)0.286Vp-p, 75 Ohm
- Component Video
Luminance (Y)1.0Vp-p, 75 Ohm
Chrominance (C_B,C_R)0.7Vp-p, 75 Ohm
Chrominance (P_B,P_R)0.7Vp-p, 75 Ohm
- Audio input level(average) 470mVrms, 47k Ohm

Outputs:

- Video1.0Vp-p. 75 Ohm
- Audio470mVrms, 1k Ohm

Dimensions:

DL5500

- Height (in.) 40 1/16"
- Width (in.) 51 1/2"
- Depth (in.) 23 25/32"
- Weight (lbs.) 207 lbs.

D-Sub Mini 15-Pin connector Pin Assignments

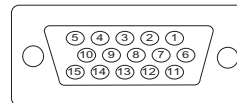

PIN NO.	SIGNAL	PIN NO.	SIGNAL
1	Red Video	9	No Connection
2	Green Video	10	Ground
3	Blue Video	11	No Connection
4	No Connection	12	SDA (DDC)
5	No Connection	13	H-Sync
6	Red Ground	14	V-Sync
7	Green Ground	15	SCL (DDC)
8	Blue Ground		

NOTE: Due to improvements, specifications in this operating guide are subject to change without notice.

FEATURE INFORMATION



As the digital era dawns, Marantz has models that provide the best possible images today....and tomorrow. Our HDTV-Ready DL5500 model incorporates Digital Light Processing™ and Multi Scan Converter to display high quality HDTV signals (1080i, 720P, 480P, 480i).

DIGITAL MICROMIRROR DEVICE™ SYSTEM

At the heart of the DL5500 model is the Digital Micromirror Device™. DMD™, an optical semiconductor chip that has an array of microscopic mirrors mounted on a standard logic device. These tiny mirrors operate as optical switches to create high resolution, full color images, with close to 1 million mirrors contained on a single 0.8 inch chip.

DIGITAL LIGHT PROCESSING™ TECHNOLOGY

Coupling the Digital Micromirror Device™ with our newly developed 10-element lens system ensures maximum picture performance, such as 1280 x 720 display resolution.

MULTI SCAN CONVERTER

The Multi Scan Converter detects many kinds of signals having different signal timings, such as, NTSC, SDTV, HDTV, VGA, SVGA, and XGA, then executes pixel format conversion and frame rate conversion to make a proper picture for a Digital Micromirror Device™.

FLEX CONVERTER TECHNOLOGY

The Flex Converter converts both NTSC and 480i SDTV signals to progressive scanned signals. This unit creates pictures like Split, Picture in Picture, Surf 3 and Freeze. It automatically detects a DVD movie with 24 frames per second recorded, then converts to progressive scanned signal with 60 frames per second. This makes a smooth and natural picture without overlapped fields.

COMPONENT VIDEO

A COMPONENT VIDEO input accepts separate blue, red & B/W signals from high resolution digital sources such as DVD or digital set-top box to provide a higher resolution picture.

3DYC (DIGITAL 3DYC COMB FILTER)

The Digital 3DYC Comb Filter analyzes three lines of information from a single video frame as well as lines from adjacent frames. This technology eliminates the flickering that a detailed pattern or scene would normally cause, for the cleanest, neatest picture possible.

PROGRESSIVE SCANNING

A standard TV uses Interlaced Scanning where each frame of video is broken into two fields, each providing alternating scan lines. This can leave noticeable scan lines and cause flickering. With Progressive Scanning, complete frames are displayed for a smoother picture with no scan lines and no flicker. This allows you to get the optimal picture quality from today's high resolution digital sources such as DVD, a digital set-top box, SVGA or with a VGA input, a computer.

DDC2B PROTOCOL SUPPORT

In order for a computer to recognize a monitor it must have DDC2B support, which you'll find in our DL5500 model. This allows the computer to recognize the resolution capability of that monitor and then automatically set itself to that level without manual adjustments.





marantz®

Limited Warranty for the Marantz Rear Projection Television

Who is covered?

You must have proof of purchase to receive warranty service.

What is covered?

- 1) Warranty coverage begins the day you purchase your Rear Projection Television, and continues for a period of one year.
- 2) Marantz America will incur all labor charges for repairs during the warranty period.
- 3) Marantz America will incur all freight charges for warranty repairs, both to Marantz and the return to the customer.
We suggest keeping all packing materials for any shipping that might be required.
- 5) All parts, including repaired and replaced parts are covered only for the original warranty period. When the warranty on the product expires, the warranty on all replaced and repaired parts also expires.

What is excluded?

Your warranty does not cover:

- 1) Labor charges for installation or setup of the product, cleaning, adjustment of customer controls on the product, and installation or repair of antenna systems outside of the product.
- 2) Improper installation, removal or maintenance, or failure to follow instructions supplied with the product.
- 3) Reception problems caused by signal conditions from cable or antenna systems outside the product.
- 4) Burn in and or phosphor damage, due to the display of still images
- 5) Repair, attempted repair or modification performed by anyone other than an authorized Marantz America service center.
- 6) Any product, on which the serial number has been defaced, modified or removed.
- 7) **Warranty is void if purchase was made from anyone other than an authorized Marantz dealer.**
- 8) Warranty is void if purchased from outside The United States of America or Canada.
- 9) Warranty only valid in the United States of America and Canada.
- 10) Damage due to lightning or power line surges, spikes and brown outs, damages that occur during shipping or transit, or damage which is attributed to acts of God.
- 11) Incidental or consequential damages resulting from the product. (Some states do not allow the exclusion of incidental or consequential damages, so the above exclusion may not apply to you. This warranty gives you specific legal rights, and you may also have other rights that vary from state to state.)
- 12) Commercial or institutional use.
- 13) Any other causes which does not relate to product defect.

Before requesting service:

Please check your owner's manual before requesting service. Adjustments of the controls and hook up guidelines discussed there may save you a service call.

To get warranty service:

Repair must be performed by an authorized service center. If you do not know of a Marantz authorized Television service center, contact your dealer. If your dealer is an authorized service center, they will arrange for repair. If your dealer is not a Marantz authorized Television service center, they will direct you to an authorized service center.

For service and warranty information, please call 1-800-654-6633

marantz®