

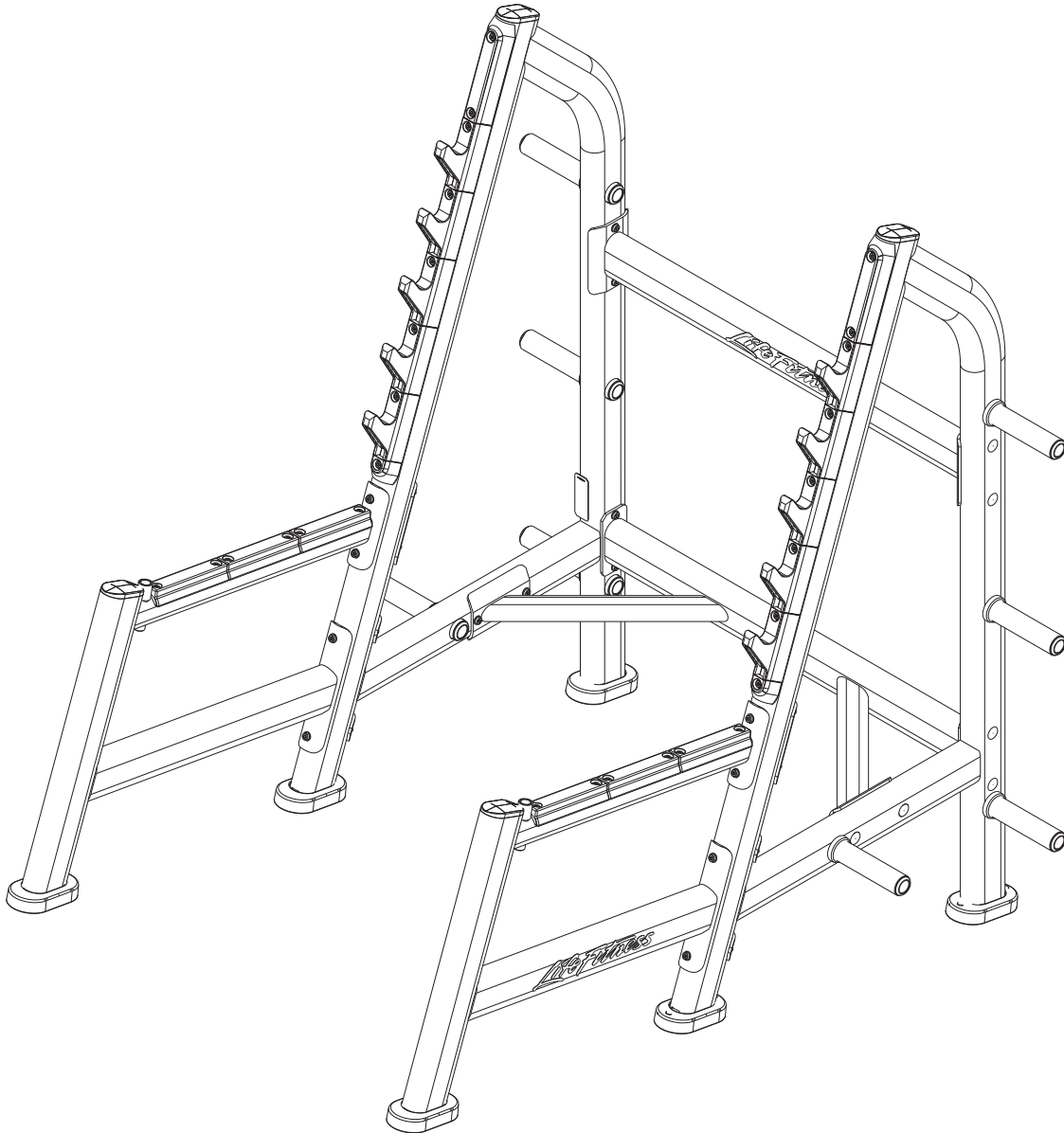

SIGNATURE SERIES
SOSR
SIGNATURE OLYMPIC SQUAT RACK



Customer Support Services
PARTS LIST

SOSR SIGNATURE OLYMPIC SQUAT RACK CONTENTS

	PAGE
COMPONENT ASSEMBLY	3
COMPONENT ASSEMBLY LEGEND	4
RIGHT FRONT REST ASSEMBLY	5
RIGHT FRONT REST ASSEMBLY LEGEND	6
LEFT FRONT REST ASSEMBLY	7
LEFT FRONT REST ASSEMBLY LEGEND	8
LEFT BACK FRAME ASSEMBLY	9
LEFT BACK FRAME ASSEMBLY LEGEND	10
RIGHT BACK FRAME ASSEMBLY	11
RIGHT BACK FRAME ASSEMBLY LEGEND	12
IMAGE	13

NOTE: SUBSTITUTE PART NUMBERS ENDING WITH 'XX' WITH THE REQUIRED COLOR CODES.

FRAME

01 = WHITE
02 = PLATINUM
03 = BLACK

PADS

01 = BLACK
99 = CUSTOM

SOSR SIGNATURE OLYMPIC SQUAT RACK COMPONENT ASSEMBLY

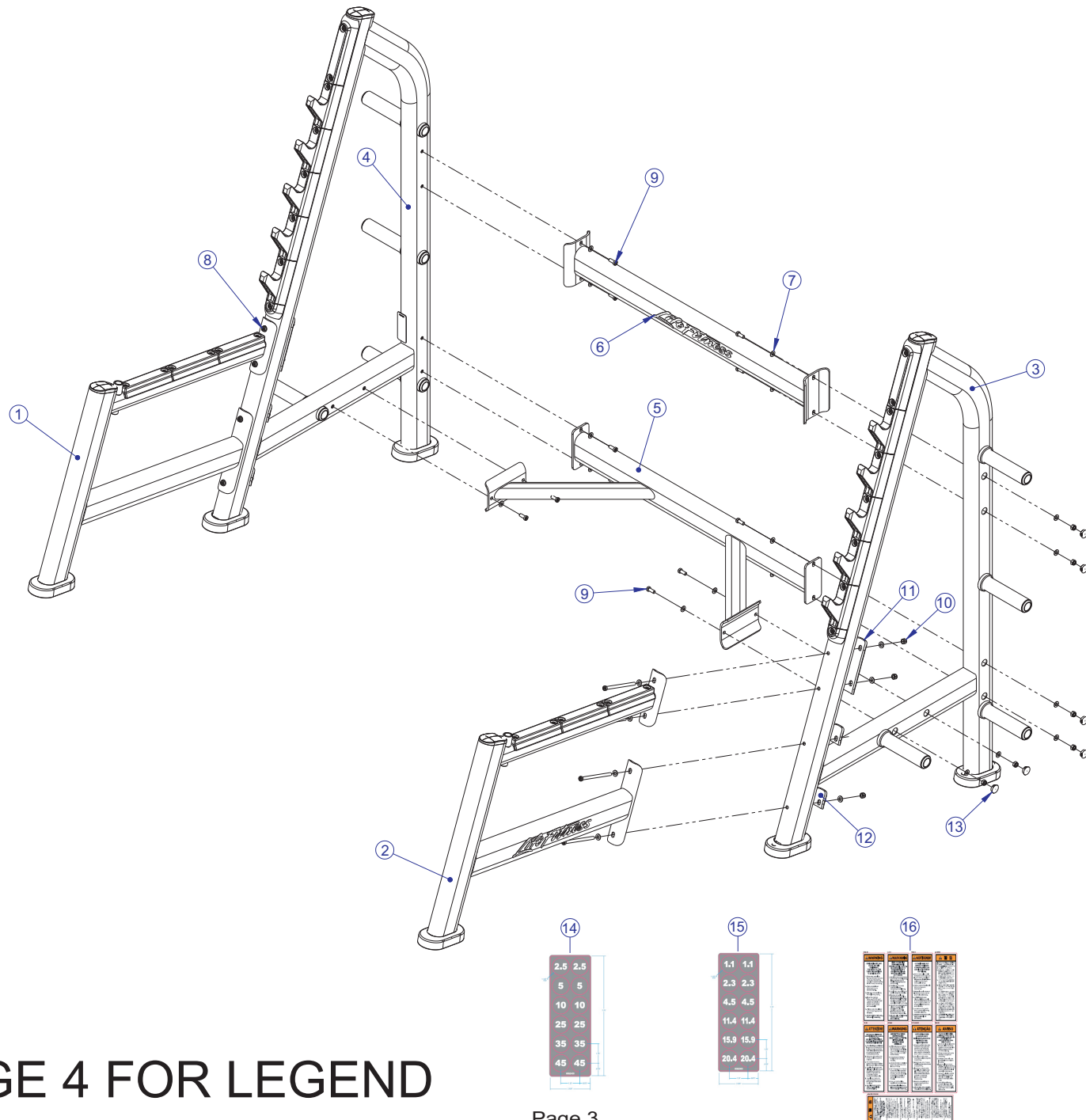

SEE PAGE 4 FOR LEGEND

SOSR SIGNATURE OLYMPIC SQUAT RACK COMPONENT ASSEMBLY LEGEND

ITEM NO.	QTY.	PART NO.	DESCRIPTION
1	1	79851xx	ASSY, SOSR, RIGHT FRONT REST
2	1	80928XX	ASSY, SOSR, LEFT FRONT REST
3	1	79853xx	ASSY, SOSR LEFT BACK FRM
4	1	79852xx	ASSY, SOSR RIGHT BACK FRM
5	1	79698xx	WLDMT, SOSR X-MEM
6	1	80750xx	ASSY, SOSR X-MEMBER (W/O HOLES)
7	40	3102514	WASHER, FLAT 3/8" SAE ST ZN
8	8	3256223	SCREW, M10 X1.5 150MM
9	12	3256202	SCREW, M10 X1.5 25MM
10	20	3242002	NUT, M10 X 1.5 HEX NYLOCK
11	2	8038801	BRACKET, SOSR
12	4	8039001	BRKT, SOSR, 3.325"
13	12	3237403	PLUG, 1" HOLE
14	1	8092701	LABEL SET, WEIGHT HORN, LB
15	1	8092601	LABEL SET, WEIGHT HORN, KG
16	1	8137801	DECAL, WARNING, VERT, MULTI-LANG SHEET

SOSR SIGNATURE OLYMPIC SQUAT RACK RIGHT FRONT REST ASSEMBLY - 79851XX

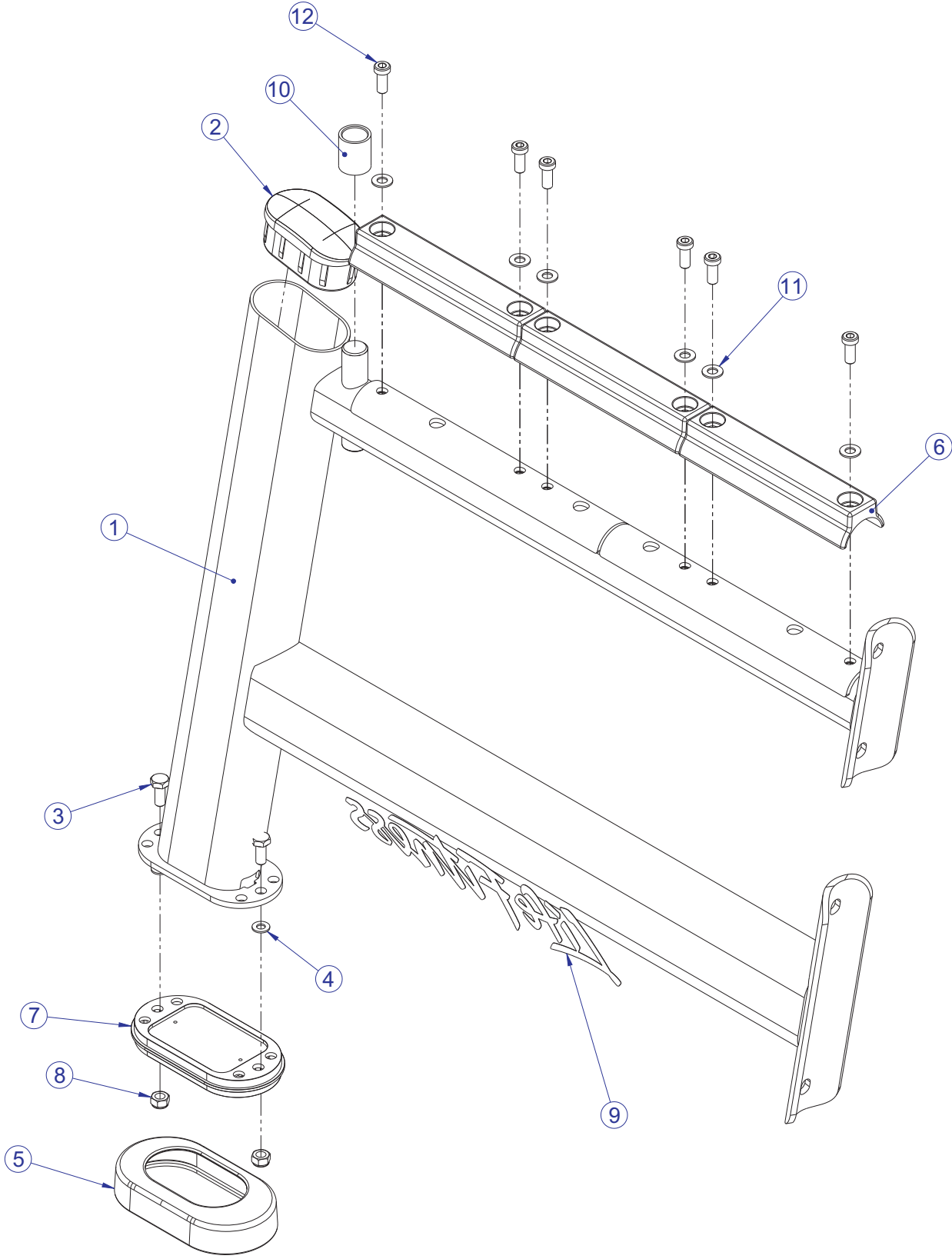

SEE PAGE 6 FOR LEGEND

SOSR SIGNATURE OLYMPIC SQUAT RACK RIGHT FRONT REST ASSEMBLY LEGEND

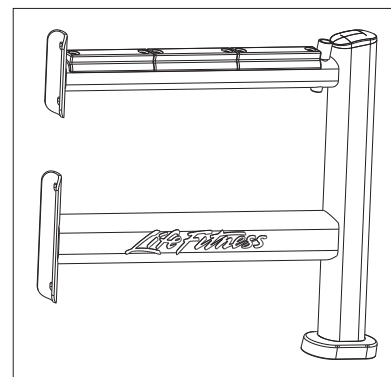

ITEM NO.	QTY.	PART NO.	DESCRIPTION
1	1	79851xx	ASSY, SOSR, RIGHT FRONT REST
2	1	7800401	CAP, LRG FLOV END
3	2	3251202	M10 X 1.5 X 25MM UNS HEX CS ST ZN
4	2	3102509	WASHER, FLAT 5/16 ID SAE ZN
5	1	7340201	COVER, FOOT-STRAIGHT
6	3	7878701	GUARD, BAR REST
7	1	7763001	FOOT, 2.20 X 4.49 FLOV
8	2	3242002	NUT, M10 X 1.5 HEX NYLOCK
9	1	8003301	LABEL, LIFE FIT 2-1/2 X 15 SG
10	1	8101501	BUMPER, SLEEVE-1.000 ID
11	6	3102514	WASHER, FLAT 3/8" SAE ST ZN
12	6	3256202	SCREW, M10 X 1.5 25MM ZN

SOSR SIGNATURE OLYMPIC SQUAT RACK LEFT FRONT REST ASSEMBLY - 80928XX

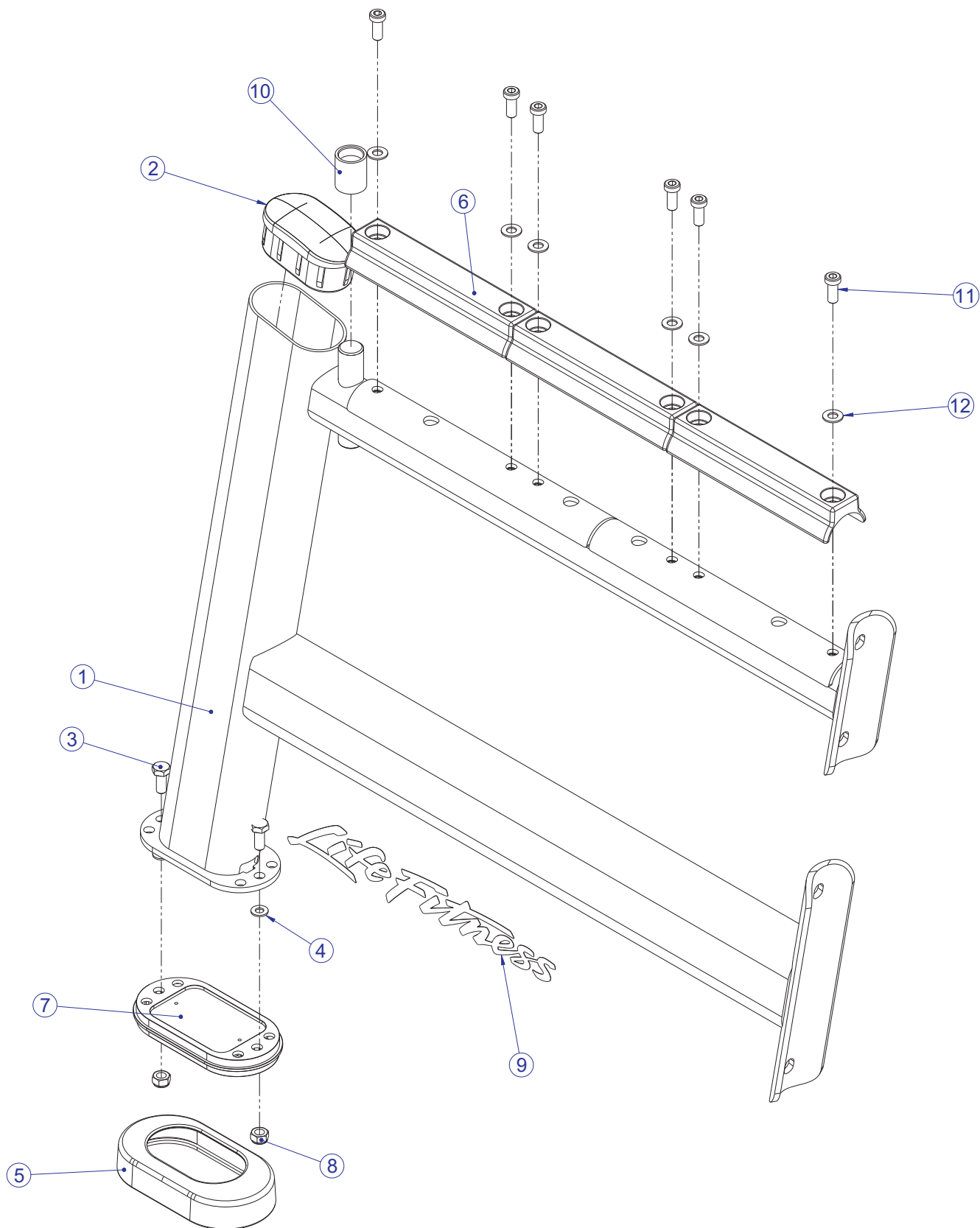

SEE PAGE 6 FOR LEGEND

SOSR SIGNATURE OLYMPIC SQUAT RACK LEFT FRONT REST ASSEMBLY LEGEND

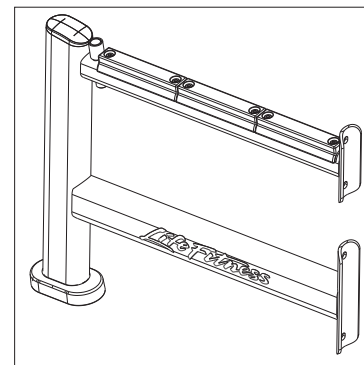

ITEM NO.	QTY.	PART NO.	DESCRIPTION
1	1	80928XX	ASSY, SOSR, LEFT FRONT REST
2	1	7800401	CAP, LRG FLOV END
3	2	3251202	SCREW, M10 X1.5 X 25MM UNS HEX CS ST ZN
4	2	3102509	WASHER, TYPE A PLAIN
5	1	7340201	COVER, FOOT - STRAIGHT
6	3	7878701	GUARD, BAR REST
7	1	7763001	FOOT, 2.50 X 4.49 FLOV
8	2	3242002	NUT, M10 X 1.5 HEX NYLOCK
9	1	8003301	LABEL, LIFE FIT 2-1/2 X 15 SG
10	1	8101501	BUMPER, SLEEVE - 1 INCH DIA
11	6	3256202	SCREW, M10 X1.5 25MM
12	6	3102514	WASHER, FLAT 3/8" SAE ST ZN

SOSR SIGNATURE OLYMPIC SQUAT RACK LEFT BACK FRAME ASSEMBLY - 79853XX

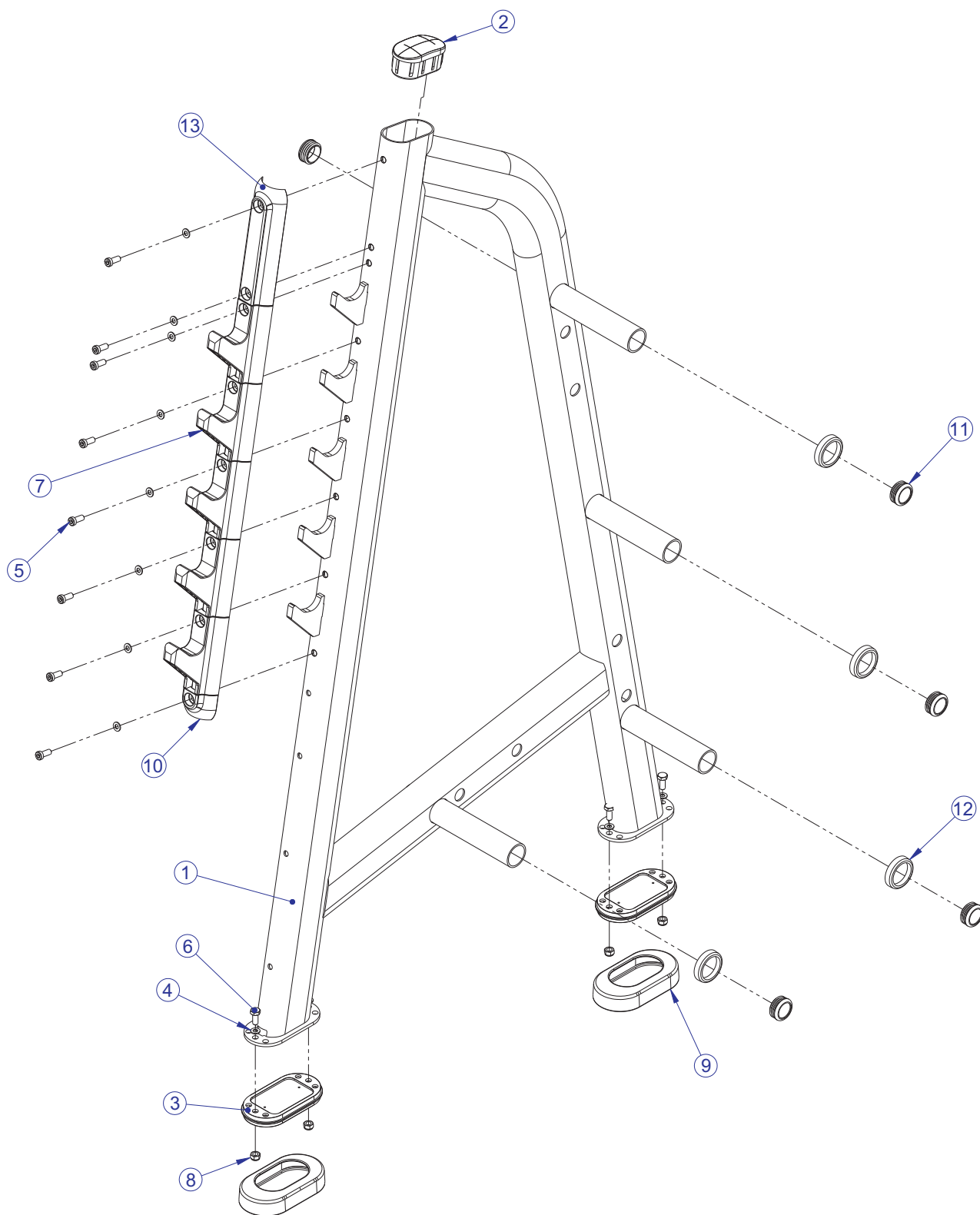

SEE PAGE 10 FOR LEGEND

SOSR SIGNATURE OLYMPIC SQUAT RACK LEFT BACK FRAME ASSEMBLY LEGEND

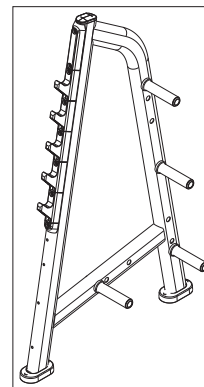

ITEM NO.	QTY.	PART NO.	DESCRIPTION
1	1	79696xx	WLDMT, SOSR LEFT BACK FRM
2	1	7800401	CAP, LRG FLOV END
3	2	7763001	FOOT, 2.50 X 4.49 FLOV
4	12	3102509	WASHER, TYPE A PLAIN
5	8	3256202	SCREW, M10 X1.5 25MM
6	4	3251202	SCREW, M10 X1.5 X 25MM UNS HEX CS ST ZN
7	5	7804501	HOOK, BAR CATCH
8	4	3242002	NUT, M10 X 1.5 HEX NYLOCK
9	2	7340201	COVER, FOOT - STRAIGHT
10	1	8077501	GUARD, BAR CATCH, LOWER
11	8	8078001	CAP, END 1.75 DIA RD 14-20 GA
12	4	8094401	RING, WT HORN
13	1	7804601	GUARD, BAR CATCH

SOSR SIGNATURE OLYMPIC SQUAT RACK RIGHT BACK FRAME ASSEMBLY - 79852XX

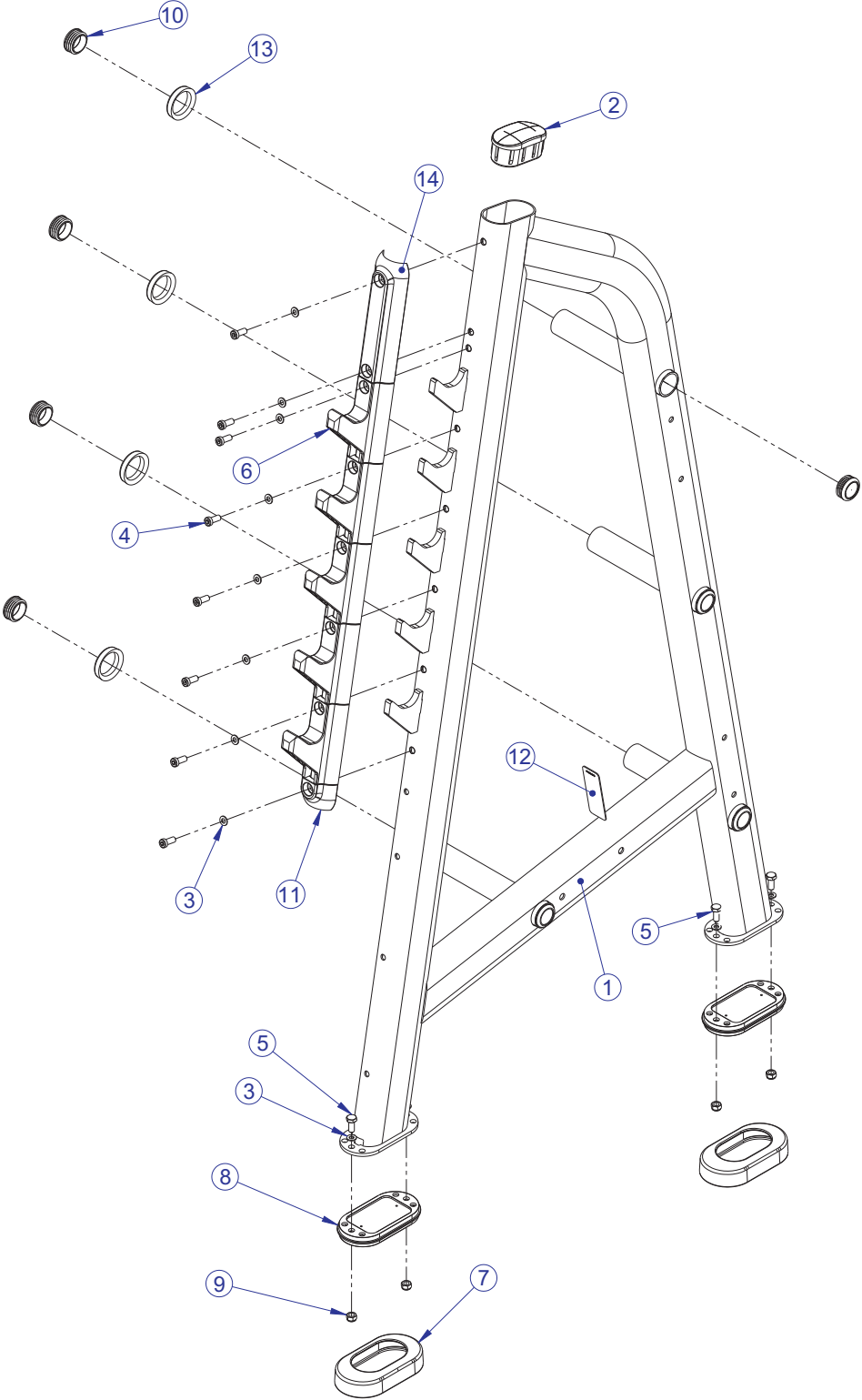

SEE PAGE 12 FOR LEGEND

SOSR SIGNATURE OLYMPIC SQUAT RACK RIGHT BACK FRAME ASSEMBLY LEGEND

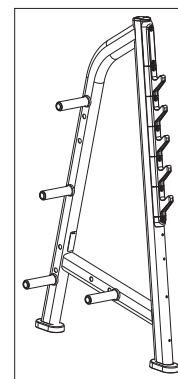

ITEM NO.	QTY.	PART NO.	DESCRIPTION
1	1	79852xx	ASSY, SOSR RIGHT BACK FRM
2	1	7800401	CAP, LRG FLOV END
3	13	3102509	WASHER, TYPE A PLAIN
4	8	3256202	SCREW, M10 X1.5 25MM
5	5	3251202	SCREW, M10 X1.5 X 25MM UNS HEX CS ST ZN
6	5	7804501	HOOK, BAR CATCH
7	2	7340201	COVER, FOOT - STRAIGHT
8	2	7763001	FOOT, 2.50 X 4.49 FLOV
9	4	3242002	NUT, M10 X 1.5 HEX NYLOCK
10	8	8078001	CAP, END 1.75 DIA RD 14-20 GA
11	1	8077501	GUARD, BAR CATCH, LOWER
12	1	7002401	LABEL, V WARNING 4.5 X 1.625
13	4	8094401	RING, WT HORN
14	1	7804601	GUARD, BAR CATCH

SOSR SIGNATURE OLYMPIC SQUAT RACK IMAGE

