

**SHARP®**

**CS-1194H**  
**CS-2194H**

**ELECTRONIC PRINTING CALCULATOR**  
**CALCULATRICE IMPRIMANTE ÉLECTRONIQUE**  
**CALCULADORA IMPRESORA ELECTRÓNICA**

**OPERATION MANUAL**  
**MODE D'EMPLOI**  
**MANUAL DE MANEJO**

ENGLISH .....	Page 2
CALCULATION EXAMPLES .....	Page 26
FRANÇAIS .....	Page 10
EXEMPLES DE CALCULS .....	Page 26
ESPAÑOL .....	Página 18
EJEMPLOS DE CALCULOS .....	Página 26

## In U.S.A.:

This device complies with Part 15 of the FCC Rules. Operation is subject to the following two conditions: (1) This device may not cause harmful interference, and (2) this device must accept any interference received, including interference that may cause undesired operation.

**WARNING** - FCC Regulations state that any unauthorized changes or modifications to this equipment not expressly approved by the manufacturer could void the user's authority to operate this equipment.

**Note:** This equipment has been tested and found to comply with the limits for a Class B digital device, pursuant to Part 15 of the FCC Rules.

These limits are designed to provide reasonable protection against harmful interference in a residential installation. This equipment generates, uses, and can radiate radio frequency energy and, if not installed and used in accordance with the instructions, may cause harmful interference to radio communications. However, there is no guarantee that interference will not occur in a particular installation. If this equipment does cause harmful interference to radio or television reception, which can be determined by turning the equipment off and on, the user is encouraged to try to correct the interference by one or more of the following measures:

- Reorient or relocate the receiving antenna.
- Increase the separation between the equipment and receiver.
- Connect the equipment into an outlet on a circuit different from that to which the receiver is connected.
- Consult the dealer or an experienced radio/TV technician for help.

### Caution!

The socket outlet shall be installed near the equipment and shall be easily accessible.

### Attention!

La prise de courant murale doit être installée à proximité de l'appareil et doit être facilement accessible.

### Aviso!

El tomacorriente debe estar instalado cerca del equipo y debe quedar bien accesible.

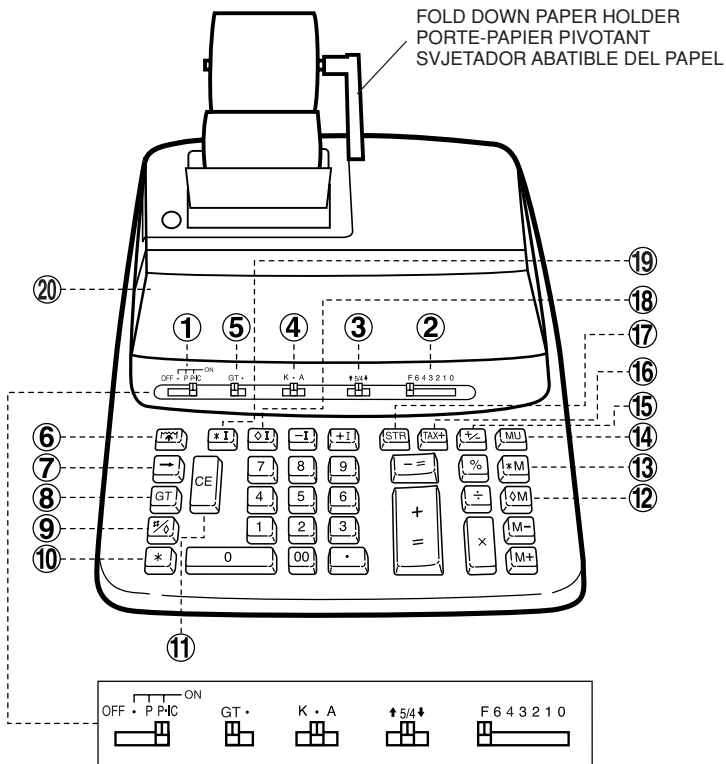

- (A) For use with the paper holder.  
 Quand on utilise le porte-papier.  
 Para usar con el sujetador del papel.

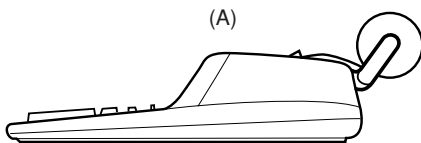

- (B) Not for use.  
 Quand on ne l'utilise pas.  
 No se utiliza.

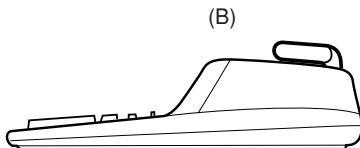

## INTRODUCTION

Thank you for your purchase of the SHARP electronic calculator, model CS-1194H/2194H. Your SHARP calculator is specially designed to save work and increase efficiency in all business applications and general office calculations. Careful reading of this manual will enable you to use your new SHARP calculator to its fullest capability.

Note: One of the models described in this manual may not be available in some countries.

## OPERATIONAL NOTES

To insure trouble-free operation of your SHARP calculator, we recommend the following:

1. The calculator should be kept in areas free from extreme temperature changes, moisture, and dust.
2. A soft, dry cloth should be used to clean the calculator. Do not use solvents or a wet cloth.
3. Since this product is not waterproof, do not use it or store it where fluids, for example water, can splash onto it. Raindrops, water spray, juice, coffee, steam, perspiration, etc. will also cause malfunction.
4. If you are not going to use the calculator for a time period, please pull out the power cord to cut electricity completely. In this case, the presently stored tax/di-  
count rate will be cleared.
5. If service should be required on this equipment, use only a SHARP servicing dealer, a SHARP approved service facility or SHARP repair service where available.
6. Do not wind the AC cord around the body or otherwise forcibly bend or twist it.

### WARNING

THE VOLTAGE USED MUST BE THE SAME AS SPECIFIED ON THIS CALCULATOR. USING THIS CALCULATOR WITH A VOLTAGE HIGHER THAN THAT SPECIFIED IS DANGEROUS AND MAY RESULT IN A FIRE OR OTHER TYPE OF ACCIDENT CAUSING DAMAGE. SHARP WILL NOT BE HELD RESPONSIBLE FOR ANY DAMAGE RESULTING FROM USE OF THIS CALCULATOR WITH OTHER THAN THE SPECIFIED VOLTAGE.

# CONTENTS

	Page
• OPERATING CONTROLS .....	3
• INK RIBBON REPLACEMENT .....	7
• PAPER ROLL REPLACEMENT .....	8
• ERRORS .....	9
• SPECIFICATIONS .....	9
• CALCULATION EXAMPLES .....	26
• TAX RATE CALCULATIONS .....	39
• DISCOUNT RATE CALCULATION .....	41

## OPERATING CONTROLS

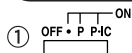

### POWER SWITCH; PRINT / ITEM COUNT MODE SELECTOR:

“OFF”: Power OFF.

“•”: Power ON. Set to the non-print mode.  
(“••• ... •••-P” will be printed.)

“P”: Power ON. Set to the print mode.  
(“••• ... •••+P” will be printed.)

“P•IC”: Power ON. Set to the print and item count mode.

The counter will count the number of times that  $\boxed{\pm}$  has been pressed in addition.

- Notes:
- Each time  $\boxed{-}$  is used in subtraction, 1 will be subtracted from the count.
  - The count is printed when the calculated result is obtained.
  - Pressing of  $\boxed{*}$ ,  $\boxed{\times}$  or  $\boxed{+}$  clears the counter.
  - The counter has a maximum capacity of 3 digits (up to  $\pm 999$ ).  
If the count exceeds the maximum, the counter will recount from zero.

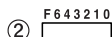

### DECIMAL SELECTOR:





Presets the number of decimal places in the answer.



In the “F” position, the answer is displayed in the floating decimal system.

③ **ROUNDING SELECTOR:**

Example: Set decimal selector to “2”.

 $4 \div 9 = 0.444 \dots$  ,  $5 \div 9 = 0.555 \dots$ 

	4  9 	5  9 
<b>↑</b>	0.45	0.56
5/4	0.44	0.56
<b>↓</b>	0.44	0.55

Note: The decimal point floats during successive calculation by the use of  or .

If the decimal selector is set to “F” then the answer is always rounded down (↓).

④ **CONSTANT / ADD MODE SELECTOR:**



“K” : The following constant functions will be performed:

**Multiplication:** The calculator will automatically remember the first number entered (the multiplicand) and  instruction.

**Division:** The calculator will automatically remember the second number entered (the divisor) and  instruction.

“•”: Neutral





“A”: Use of the Add mode permits addition and subtraction of numbers without entry of the decimal point. When the Add mode is activated, the decimal point is automatically positioned according to the decimal selector setting.

Use of , , and  will automatically override the Add mode and decimally correct answers will be printed at the preset decimal position.

⑤ **GRAND TOTAL MODE SELECTOR:**

“GT”: This selector will accumulate the following:

(“ \* +” will be printed.)

1. Addition and subtraction totals obtained with .
2. Product and quotient totals obtained with  or .
3. Answers obtained with  or .

“•”: Neutral

⑥ **PAPER FEED KEY**⑦ **LAST DIGIT CORRECTION KEY**⑧ **GRAND TOTAL KEY:**



Prints and clears the “GT” memory contents.

⑨ 

**NON-ADD / SUBTOTAL KEY:**

**Non-Add** – When this key is pressed right after entry of a number in the Print mode, the entry is printed on the left-hand side with “#”.

This key is used to print out numbers not subject to calculations such as codes, dates, etc.

**Subtotal** – Used to get subtotal(s) of additions and/or subtractions. When pressed following  or , the subtotal is printed with “◇” and the calculation may be continued.

**By pressing this key even in the Non-print mode, the displayed number is printed with “P”.**

⑩ 

**TOTAL KEY:**

Prints the total of addition and subtraction with “\*”.

This key also serves as a clear key for the calculation register and resets an error condition.

⑪ 

**CLEAR ENTRY KEY:**

Clears numbers entered prior to use of a function key.

Also used to clear an overflow error caused by an entry.

⑫ 

**FIRST RECALL MEMORY KEY**

⑬ 

**FIRST RECALL AND CLEAR MEMORY KEY**

⑭ 

**MULTIPLE USE KEY:**

Performs mark-ups, percent change and automatic add-on/discount.

⑮ 

**CHANGE SIGN KEY:**

Changes the algebraic sign of a number (i.e. positive to negative or negative to positive).

⑯ 

**TAX-INCLUDING KEY:**

This key is used for calculations with the tax/discount rate.

⑰ 

**STORE KEY:**

This key is used to store the tax/discount rate.

- A maximum of 4 digits can be stored (decimal point is not counted as a digit).
- To store a discount rate, press  first.
- Only one rate can be stored. If you enter a new rate, the previous rate will be cleared.

⑱ 

**SECOND RECALL MEMORY KEY**

⑲ 

**SECOND RECALL AND CLEAR MEMORY KEY**

⑳ DISPLAY

Display format:

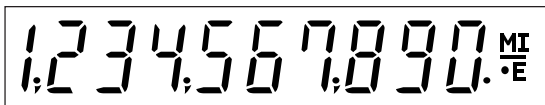

(CS-1194H)

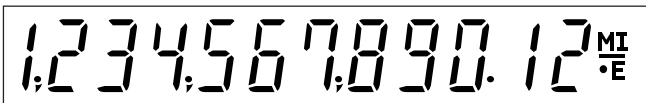

(CS-2194H)

Symbols:

**M** : **First memory symbol**

Appears when a number has been stored in First memory.

**I** : **Second memory symbol**

Appears when a number has been stored in Second memory.

**-** : **Minus symbol**

Appears when a number is a negative.

**E** : **Error symbol**

Appears when an overflow or other error is detected.

**•** : **Grand total memory symbol**

Appears when a number is in the grand total memory.



## INK RIBBON REPLACEMENT

1. Remove the paper roll from the calculator. (Tear the paper and remove it from the print mechanism by using )
2. **Set the power switch to OFF.**  
**Make sure that the print wheel has stopped.**
3. Remove the printer cover by sliding it towards the back of the calculator. (Fig. 1)
4. Remove the used ribbon.
5. Install the new ribbon.
6. With the black side of the ribbon facing upwards, place one of the reels on the reel shaft on the right. (Fig. 2) Make sure that the reel is securely in place.
7. Thread the ribbon around the outside of the metal guides. (Fig. 3)
8. Take up any slack by manually turning one of the reels.
9. Replace the printer cover.
10. Replace the paper roll.

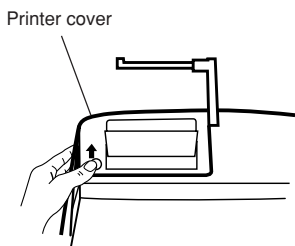

Fig. 1

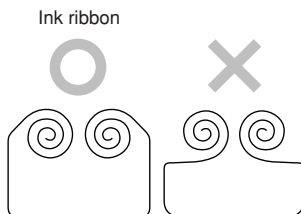

Fig. 2

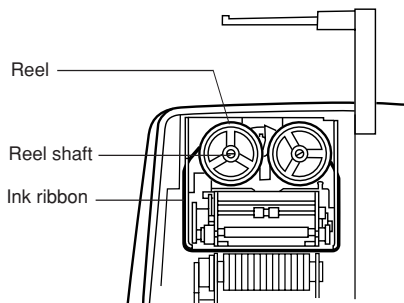

Fig. 3

## PAPER ROLL REPLACEMENT

1. Lift the paper holder up. (Fig. 1)
2. Fold the leading edge of the paper roll 3 to 5 cm. (Do not fold it slantwise.) (Fig. 2)
3. Insert the paper roll from the left side of the paper holder and make sure the paper roll is set in the proper direction (with the paper feeding from the bottom). (Fig. 3)
4. Insert the leading edge of the paper into the opening directly behind the print mechanism. (Fig. 4)
5. Press the paper feed key and feed the paper under the edge of the paper cutter. (Fig. 5)

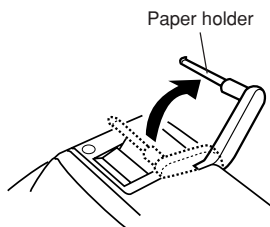

Fig. 1

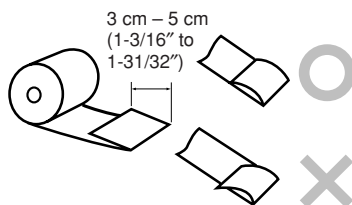

Fig. 2

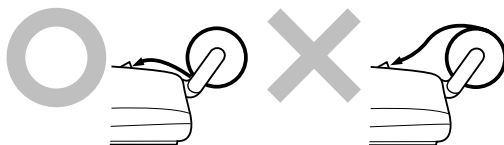

Fig. 3

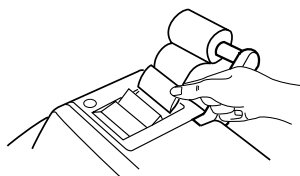

Fig. 4

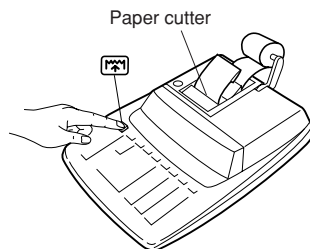

Fig. 5

DO NOT PULL THE PAPER BACKWARDS AS THIS MAY DAMAGE THE  
PRINTER MECHANISM.

## ERRORS

There are several situations which will cause an overflow or an error condition. When this occurs, the error symbol "E" will be displayed and all keys will electronically lock.

The contents of the memory at the time of the error are retained.

If an "0•E" is displayed at the time of the error,  $\boxed{*}$  must be used to clear the calculator.

If an "E" with any numerals except zero is displayed, the error may be cleared with  $\boxed{CE}$  or  $\boxed{\rightarrow}$  and the calculation can still be continued.

### Error conditions:

1. Entry of more than 10 digits or 9 decimals. (CS-1194H)  
Entry of more than 12 digits or 11 decimals. (CS-2194H)  
This error can be cleared with  $\boxed{CE}$  or  $\boxed{\rightarrow}$ .
2. When the integer portion of an answer exceeds 10 digits. (CS-1194H)  
When the integer portion of an answer exceeds 12 digits. (CS-2194H)
3. When the integer portion of the contents of the memory exceeds 10 digits. (CS-1194H)  
(Ex.  $\boxed{*M}$  9999999999  $\boxed{M+}$  1  $\boxed{M+}$ )  
When the integer portion of the contents of the memory exceeds 12 digits. (CS-2194H)  
(Ex.  $\boxed{*M}$  999999999999  $\boxed{M+}$  1  $\boxed{M+}$ )
4. When any number is divided by zero. (Ex.  $5 \boxed{\div} 0 \boxed{=}$ )

## SPECIFICATIONS

Operating capacity:	10 digits (CS-1194H) 12 digits (CS-2194H)
Power source:	AC: 120V, 60Hz
Calculations:	Four arithmetic calculations, constant multiplication and division, power calculation, add-on/discount calculation, repeat addition and subtraction, reciprocal calculation, grand total calculation, item count calculation, markup calculation, memory calculation, etc.

### PRINTING SECTION

Printer:	Mechanical printer
Printing speed:	Approx. 4.3 lines/sec.
Printing paper:	57 mm (2-1/4") ~ 58 mm (2-9/32") wide 80 mm (3-5/32") in diameter (max.)
Operation temperature:	0°C ~ 40°C (32°F ~ 104°F)
Power consumption:	126 mA
Dimensions:	250 mm (W) × 345 mm (D) × 78 mm (H) 9-27/32" (W) × 13-19/32" (D) × 3-1/16" (H)
Weight:	Approx. 2.0 kg (4.41 lb.)
Accessories:	1 paper roll, 1 ink ribbon and operation manual

## INTRODUCTION

Nous vous félicitons pour l'achat de cette calculatrice électronique SHARP, modèle CS-1194H/2194H. Cette calculatrice SHARP a été spécialement conçue pour vous épargner du travail et accroître l'efficacité dans toutes les applications de gestion et les calculs de bureau. Veuillez lire ce mode d'emploi attentivement pour pouvoir tirer le meilleur parti de cette nouvelle calculatrice SHARP.

Note: Les deux modèles décrits dans ce manuel ne sont pas disponibles dans certains pays.

## PRÉCAUTIONS

Afin d'assurer un fonctionnement sans ennui de la calculatrice SHARP, veuillez prendre les précautions suivantes:

1. Ne pas laisser la calculatrice dans les endroits sujets à de forts changements de température, à l'humidité, et à la poussière.
2. Pour le nettoyage de la calculatrice, utiliser un chiffon doux et sec. Ne pas utiliser de solvants ni un chiffon humide.
3. Cet appareil n'étant pas étanche, il ne faut pas l'utiliser ou l'entreposer dans des endroits où il risquerait d'être mouillé, par exemple par de l'eau. La pluie, l'eau brumisée, l'humidité, le café, la vapeur, la transpiration, etc. sont à l'origine de dysfonctionnements.
4. Si vous n'envisagez pas d'utiliser la calculatrice pendant une longue période, débranchez la fiche de cordon d'alimentation. Dans ce cas, le taux de taxe/remise présentement mis en mémoire est effacé.
5. Si une réparation s'avérait nécessaire, confier l'appareil à un distributeur agréé par Sharp.
6. Ne pas entourer le cordon électrique autour du corps de l'appareil ou ne pas le courber ou le tordre fortement.

## ATTENTION

LA TENSION UTILISÉE DOIT ÊTRE IDENTIQUE À LA TENSION SPÉCIFIÉE SUR CETTE CALCULATRICE. L'UTILISATION DE CETTE CALCULATRICE AVEC UNE TENSION PLUS ÉLEVÉE QUE CELLE SPÉCIFIÉE EST DANGEREUSE ET PEUT ENTRAÎNER UN INCENDIE OU TOUT AUTRE TYPE D'ACCIDENT PROVOQUANT DES DOMMAGES. SHARP DÉCLINE TOUTE RESPONSABILITÉ EN CAS D'ACCIDENT RÉSULTANT DE L'UTILISATION DE CETTE CALCULATRICE AVEC UNE TENSION AUTRE QUE LA TENSION SPÉCIFIÉE.

## TABLE DES MATIÈRES

	Page
• LES COMMANDES .....	11
• REMPLACEMENT DU RUBAN ENCREUR .....	15
• REMPLACEMENT DU ROULEAU DE PAPIER .....	16
• ERREURS .....	17
• FICHE TECHNIQUE .....	17
• EXEMPLES DE CALCULS .....	26
• CALCULS DE TAXE .....	39
• CALCUL D'UN REMISE .....	41

## LES COMMANDES

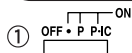

### INTERRUPTEUR; SÉLECTEUR DE MODE D'IMPRESSION / COMPTEUR D'ARTICLES:

“OFF”: Mise hors tension.

“•”: Mise sous tension. Pour choisir le mode de non impression.  
 (“••• ... ••• -P” sera imprimé.)

“P”: Mise sous tension. Pour choisir le mode impression.  
 (“••• ... ••• +P” sera imprimé.)

“P•IC”: Mise sous tension. Pour choisir le mode d'impression et de comptage d'articles.

Le compteur comptera le nombre de fois que  $\boxed{\pm}$  a été appuyée en addition.

- Note:
- Chaque fois que l'on agit sur  $\boxed{-=}$  en soustraction, 1 sera soustrait du compte.
  - Le compte est imprimé lorsque le résultat calculé est obtenu.
  - Le compteur revient à zéro en agissant sur  $\boxed{*}$ ,  $\boxed{\times}$  ou  $\boxed{+}$ .
  - La capacité du compteur est de 3 chiffres maximum (jusqu'à  $\pm 999$ ). Si le compte dépasse ce maximum, le compteur repartira de zéro.

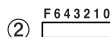







### SÉLECTEUR DE DÉCIMALE:

Il préétablit le nombre de décimales dans le résultat. Pour la position “F”, le résultat est affiché dans le système à virgule flottante.

③ **SÉLECTEUR D'ARRONDI:**



Exemple: Placer le sélecteur de décimale sur "2".

 $4 \div 9 = 0,444 \dots$  ,  $5 \div 9 = 0,555 \dots$ 

	4  9 	5  9 
	0.45	0.56
5/4	0.44	0.56
	0.44	0.55



Note: La virgule flotte durant un calcul successif en utilisant  ou .Pour la position "F", le résultat est affiché dans le système à virgule flottante (.④ **SÉLECTEUR CONSTANTE / ADDITION:**

"K" : Les opérations suivantes avec constante sont possibles.

**Multiplication:** La calculatrice rappelle automatiquement le premier nombre introduit (le multiplicande) ainsi que l'instruction .**Division:** La calculatrice rappelle automatiquement le deuxième nombre introduit (le diviseur) ainsi que l'instruction .





"•": Neutre.

"A": Il est possible d'additionner ou de soustraire des nombres sans qu'il soit nécessaire de taper le point décimal. Ce dernier est automatiquement positionné en fonction du réglage effectué.

L'emploi de , , et  annule ce mode de fonctionnement et le résultat est imprimé en tenant compte du nombre de décimales choisies.⑤ **SÉLECTEUR DE MODE DE TOTAL GÉNÉRAL:**

"GT": Ce sélecteur accumulera ce qui suit:

(" \* + " sera imprimé.)

1. Les totaux d'addition et de soustraction obtenus avec .
2. Les totaux de produit et de quotient obtenus avec  ou .
3. Les résultats obtenus avec  ou .

"•": Neutre, GT OFF (arrêt)

⑥ **TOUCHE DE MONTÉE DE PAPIER**⑦ **TOUCHE DE CORRECTION DU DERNIER CHIFFRE**⑧ **TOUCHE DE TOTAL GÉNÉRAL:**



Imprime le contenu de la mémoire du total général "GT" et l'efface.

⑨ 

#### **TOUCHE DE NON ADDITION / TOTAL PARTIEL:**

**Non addition** – Lorsqu'on agit sur cette touche juste après l'introduction d'un nombre dans le mode d'impression, l'entrée est imprimée à gauche avec "#".

Cette touche sert à imprimer des nombres qui ne sont pas sujets au calcul tels que les codes, les dates, etc.

**Total partiel** – Sert à obtenir le(s) total(aux) partiel(s) des additions et/ou des soustractions. Lorsqu'on agit sur cette touche à la suite de  ou , le total partiel est imprimé conjointement avec "◇" et le calcul peut continuer.

**En agissant sur cette touche même dans le mode de non impression, le nombre affiché est imprimé et accompagné de "P".**

⑩ 

#### **TOUCHE TOTAL:**

Imprime le total d'une addition ou d'une soustraction avec "\* \*".

Cette touche sert également de touche d'effacement des registres de calcul et annule une condition d'erreur.

⑪ 

#### **TOUCHE D'EFFACEMENT D'ENTRÉE:**

Efface un nombre qui a été introduit avant l'utilisation d'une touche de fonction.

Peut être également utilisée pour effacer une erreur de dépassement de capacité causée par une entrée.

⑫ 

#### **PREMIÈRES TOUCHE DE RAPPEL DE MÉMOIRE**

⑬ 

#### **PREMIÈRES TOUCHE DE RAPPEL ET D'EFFACEMENT DE MÉMOIRE**

⑭ 

#### **TOUCHE DE MAJORATION:**

Cette touche sert à effectuer les hausses de prix, le changement de pourcentage et les majorations/rabais automatiques.

⑮ 

#### **TOUCHE DE CHANGEMENT DE SIGNE:**

Permet de changer le signe algébrique d'un nombre (c.à.d. de positif à négatif ou de négatif à positif).

⑯ 

#### **TOUCHE DE TAXE INCLUE:**

Cette touche permet les calculs avec un taux de taxe/remise.

17 **STR**

### TOUCHE DE MISE EN MÉMOIRE:

Cette touche est utilisée pour mettre en mémoire un taux de taxe/remise.

- Le nombre de chiffres ne peut pas excéder 4 (le point décimal n'est pas considéré comme un chiffre).
- Avant de mettre en mémoire un taux de taxe/remise, appuyer sur **[+/-]**.
- Un seul taux peut être mémorisé; la mise en mémoire d'un taux efface le précédent.

18 **◊1**

### DEUXIÈME TOUCHE DE RAPPEL DE MÉMOIRE

19 **\*1**

### DEUXIÈME TOUCHE DE RAPPEL ET D'EFFACEMENT DE MÉMOIRE

20 **AFFICHAGE**

Format d'affichage:

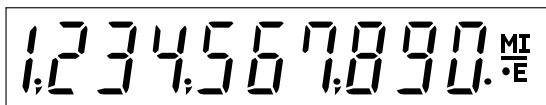

(CS-1194H)

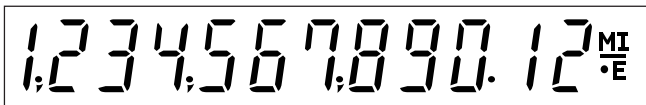

(CS-2194H)

**Symboles:**

**M** : **Symbole de première mémoire**

Visualisé lorsqu'un nombre a été mis en mémoire dans la première mémoire.

**I** : **Symbole de deuxième mémoire**

Visualisé lorsqu'un nombre a été mis en mémoire dans la deuxième mémoire.

**-** : **Symbole de soustraction**

Visualisé lorsque le nombre est négatif.

**E** : **Symbole d'erreur**

Visualisé en cas d'erreur ou de dépassement de capacité.

**•** : **Symbole de mémoire du total général**

Apparaît lorsqu'un nombre se trouve dans la mémoire du total général.



## REPLACEMENT DU RUBAN ENCREUR

1. Retirer le rouleau de papier de la calculatrice. (Déchirer le papier et le retirer du mécanisme d'impression au moyen de )
2. **Placer l'interrupteur sur la position OFF.**  
**S'assurer que la roue d'impression est arrêtée.**
3. Déposer le couvercle de l'imprimante en le faisant glisser vers l'arrière de la calculatrice. (Fig. 1)
4. Retirer le ruban usagé.
5. Placer un nouveau ruban.
6. Présenter le ruban avec son côté noir dirigé vers le haut, engager une des bobines sur l'axe de la bobine de gauche. (Fig. 2) S'assurer que la bobine est bien en place.
7. Mettre en place le ruban en le faisant passer à l'extérieur des guides métalliques. (Fig. 3)
8. Si le ruban est lâche, le tendre en tournant une des bobines à la main.
9. Remettre le couvercle de l'imprimante en place.
10. Réinstaller le rouleau de papier.

Couvercle de l'imprimante

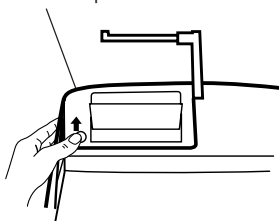

Fig. 1

Ruban encreur

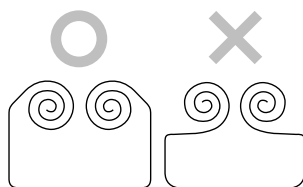

Fig. 2

Bobine  
Axe de bobine  
Ruban encreur

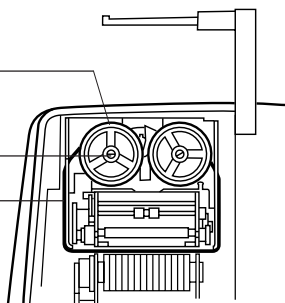

Fig. 3

## REPLACEMENT DU ROULEAU DE PAPIER

1. Soulever le porte-rouleau. (Fig. 1)
2. Plier l'amorce du rouleau de papier de 3 à 5 cm (ne jamais plier en travers). (Fig. 2)
3. Engager le rouleau de papier sur la gauche du porte-rouleau et s'assurer que le rouleau de papier est dans la bonne direction (avec l'alimentation en papier du bas) comme le montre l'illustration. (Fig. 3)
4. Engager l'amorce du rouleau de papier dans l'ouverture située juste derrière le mécanisme d'impression. (Fig. 4)
5. Appuyer sur la touche de montée de papier et faire sortir le papier derrière le coupe-papier. (Fig. 5)

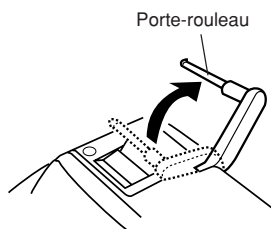

Fig. 1

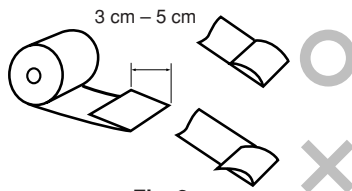

Fig. 2

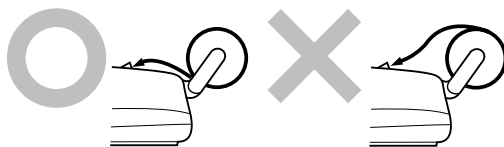

Fig. 3

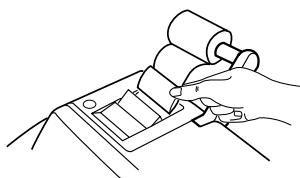

Fig. 4

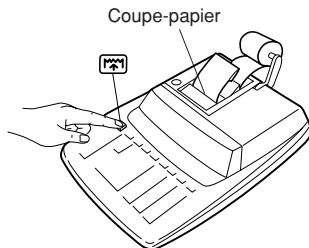

Fig. 5

NE JAMAIS TIRER SUR LE PAPIER POUR LE FAIRE SORTIR CAR CECI PEUT ENDOMMAGER LE MÉCANISME D'IMPRESSION.

## ERREURS

Il existe plusieurs cas qui entraînent un dépassement de capacité ou une situation d'erreur. Si cela se produit, le symbole d'erreur "E" sera affiché et toutes les touches seront verrouillées électroniquement. Le contenu de la mémoire au moment de l'erreur est préservé.

Si un "0•E" s'affiche au moment de l'erreur, il faut utiliser  $\boxed{\times}$  pour effacer l'erreur. Si un "E" accompagné de plusieurs chiffres (sauf zéro) s'affiche l'erreur peut être effacée à l'aide de  $\boxed{CE}$  ou  $\boxed{\rightarrow}$  et le calcul peut continuer.

### Conditions d'erreur:

1. Introduction de plus de 10 chiffres ou 9 décimales. (CS-1194H)  
Introduction de plus de 12 chiffres ou 11 décimales. (CS-2194H)  
Cette erreur peut être effacée à l'aide de  $\boxed{CE}$  ou  $\boxed{\rightarrow}$ .
2. Lorsque la partie entière d'un résultat dépasse 10 chiffres. (CS-1194H)  
Lorsque la partie entière d'un résultat dépasse 12 chiffres. (CS-2194H)
3. Lorsque la partie entière du nombre en mémoire excède 10 chiffres. (CS-1194H)  
(Ex.  $\boxed{*M}$  9999999999  $\boxed{M+}$  1  $\boxed{M+}$ )  
Lorsque la partie entière du nombre en mémoire excède 12 chiffres. (CS-2194H)  
(Ex.  $\boxed{*M}$  999999999999  $\boxed{M+}$  1  $\boxed{M+}$ )
4. Lorsqu'un nombre est divisé par zéro. (Ex. 5  $\boxed{\div}$  0  $\boxed{\pm}$ )

## FICHE TECHNIQUE

Capacité de travail:	10 chiffres (CS-1194H) 12 chiffres (CS-2194H)
Alimentation:	CA: 120V, 60Hz
Calculs:	Quatre opérations arithmétiques, multiplication et division avec constante, calcul de puissance, calcul de majoration/rabais, addition et soustraction successives, calcul inverse, calcul avec mémoire, comptage des articles, calcul de hausse, impression de non addition, calcul de total général, etc.

### SECTION IMPRESSION

Imprimante:	Imprimante mécanique
Vitesse d'impression:	Env. 4,3 lignes/s
Papier d'impression:	Largeur: 57 mm ~ 58 mm Diamètre (maxi.): 80 mm
Température:	0°C ~ 40°C
Consommation:	126 mA
Dimensions:	250 mm (L) × 345 mm (P) × 78 mm (H)
Poids:	Env. 2,0 kg
Accessoires:	1 rouleau de papier, 1 ruban encreur et mode d'emploi

## INTRODUCCION

Muchísimas gracias por haber adquirido la calculadora electrónica de SHARP modelo CS-1194H/2194H. La presente calculadora ha sido expresamente concebida con el fin de ahorrarle trabajo y lograr una mayor eficacia en todas sus aplicaciones de negocios y cálculos generales de oficina. Una atenta lectura del presente manual le permitirá usar su nueva calculadora SHARP al máximo de su capacidad.

**Nota:** Puede que uno de los dos modelos descritos en este manual no esté disponible en algunos países.

## NOTAS AL MANEJARLA

A fin de que su calculadora SHARP funcione sin averías, le recomendamos lo siguiente:

1. Evite dejar la calculadora en ambientes en que haya cambios de temperatura, humedad y polvo bastante notables.
2. Al limpiar la calculadora, utilice un paño suave y seco. No use disolventes ni tampoco un paño húmedo.
3. Debido a que este producto no es a prueba de agua, no deberá ser utilizado o guardado en lugares donde pudiera ser salpicado por líquidos, por ejemplo agua. Gotas de lluvia, salpicaduras de agua, jugos o zumos, café, vapor, transpiración, etc. también perjudican el funcionamiento del producto.
4. Si no va a utilizar la calculadora durante algún tiempo, desconecte el cable de alimentación para cortar completamente la electricidad. En este caso, el tipo de impuesto/descuento actualmente almacenado se borrará.
5. Si se requiere algún servicio técnico o reparación en este equipo, diríjase sólo a un distribuidor SHARP de reparaciones, a un centro de servicio autorizado por SHARP o a un centro de reparaciones SHARP cercano a su localidad.
6. No bobine el cable de CA alrededor de la calculadora, y no lo doble o retuerza a la fuerza.

### AVISO

EL VOLTAJE USADO DEBE SER EL MISMO QUE EL ESPECIFICADO EN ESTA CALCULADORA. USAR ESTA CALCULADORA CON UN VOLTAJE SUPERIOR AL ESPECIFICADO RESULTA PELIGROSO Y PUEDE CAUSAR UN INCENDIO U OTRO TIPO DE ACCIDENTE. SHARP NO SE HACE RESPONSABLE DE NINGUN DAÑO DEBIDO AL USO DE ESTA CALCULADORA CON UN VOLTAJE DIFERENTE DEL ESPECIFICADO.

## INDICE

	Página
• CONTROLES DE FUNCIONAMIENTO .....	19
• CAMBIO DE LA CINTA ENTINTADA .....	23
• CAMBIO DEL ROLLO DEL PAPEL .....	24
• ERRORES .....	25
• ESPECIFICACIONES TECNICAS .....	25
• EJEMPLOS DE CALCULOS .....	26
• CALCULOS CON EL TIPO DE IMPUESTO .....	39
• CALCUL CON EL TIPO DE DESCUENTO .....	41

## CONTROLES DE FUNCIONAMIENTO

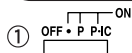

### INTERRUPTOR DE CORRIENTE; SELECTOR DEL MODO DE IMPRESION / MODO PARA CONTAR ARTICULOS:

“OFF”: Apagado (OFF)

“•”: Encendido (ON). Fija el modo de no impresión.  
(Se imprimirá “••• ... ••• -P”.)

“P”: Encendido (ON). Fija el modo de impresión.  
(Se imprimirá “••• ... ••• +P”.)

“P•IC”: Encendido (ON). Fija el modo de impresión y de cuenta de artículos.

El contador contará las veces que se ha apretado  $\boxed{\pm}$  en la suma.

Notas: • Cada vez que se use  $\boxed{-=}$  en la resta, se restará 1 de la cuenta.

• La cuenta queda impresa cuando se obtiene el resultado calculado.

• Al apretar  $\boxed{*}$ ,  $\boxed{\times}$  o  $\boxed{\div}$  se borra el contenido del contador.

• El contador tiene una capacidad de un máximo de 3 cifras (hasta  $\pm 999$ ). Si la cuenta excede el máximo, el contador vuelve a contar partiendo de cero.

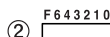

### SELECTOR DECIMAL:





Prefija el número de lugares decimales de la respuesta.



En la posición “F”, la respuesta aparecerá en la exhibición en el sistema decimal flotante.

③ **SELECTOR DE REDONDEO:**

Ejemplo: Fija el selector decimal en “2”.

 $4 \div 9 = 0,444 \dots$  ,  $5 \div 9 = 0,555 \dots$ 

	4  9 	5  9 
↑	0.45	0.56
5/4	0.44	0.56
↓	0.44	0.55

Nota: El punto (= coma) decimal flota mientras se hacen cálculos sucesivos usando  o .

Si el selector decimal se coloca en “F”, la respuesta siempre se redondea por defecto (↓).

④ **SELECTOR DEL MODO DE CONSTANTE / SUMA:**



“K” : Se podrán realizar las siguientes funciones de constantes:

**Multiplicación:** La calculadora retendrá automáticamente el primer factor registrado (el multiplicando) y la instrucción .

**División:** La calculadora retendrá automáticamente el segundo factor registrado (el divisor) y la instrucción .

“•”: Posición neutra.

“A”: Utilizando el modo de suma se pueden sumar y restar números sin registrar el punto decimal. Cuando se activa el modo de suma, el punto decimal se coloca automáticamente de acuerdo con el ajuste del selector decimal.

El uso de , , y  desactivará automáticamente el modo de suma y las respuestas decimalmente correctas se imprimirán en la posición decimal prefijada.

⑤ **SELECTOR DEL MODO DE TOTAL GLOBAL:**

“GT”: Este selector hará que se acumule lo siguiente:

(Se imprimirá “\*+”).

1. Totales de suma y resta obtenidos con .2. Totales de productos y cocientes obtenidos con  o .3. Resultados obtenidos con  o .

“•”: Posición neutra, total global, desactivada.

⑥ **TECLA DE AVANCE DEL PAPEL**⑦ **TECLA DE CORRECCION DE LA ULTIMA CIFRA**⑧ **TECLA DE TOTAL GLOBAL:**



Imprime y borra el contenido de la memoria de total global “GT”.

9 

#### **TECLA DE NO SUMA / TOTAL PARCIAL:**

**No-suma –** Cuando se aprieta esta tecla inmediatamente después de haber ingresado un número en el modo de impresión, el número registrado se imprime a la izquierda, junto con “#”. Esta tecla se usa para imprimir números que no están sujetos a cálculos como, por ejemplo, códigos, fechas, etc.

**Total parcial –** Se usa para obtener uno o varios totales parciales de sumas y/o restas.

Cuando se aprieta a continuación de  o , se imprimirá el total parcial junto con “ $\diamond$ ”, pudiéndose seguir con los cálculos.

**Al apretar esta tecla, incluso en el modo de no impresión, se imprimirá el número que aparece en la exhibición con “P”.**

10 

#### **TECLA DE TOTAL:**

Imprime el total de la suma y resta con “\*”. Esta tecla también sirve de tecla de borrado para los registros de cálculos, y anula un estado de error.

11 

#### **TECLA DE BORRADO DE ENTRADAS:**

Sirve para cancelar un número introducido antes de utilizar una tecla de función. Se usa también para cancelar un error por exceso de capacidad causado por una entrada.

12 

#### **TECLA DE RECUPERACIÓN DE LA PRIMERA MEMORIA**

13 

#### **TECLA DE RECUPERACIÓN Y BORRADO DE LA PRIMERA MEMORIA**

14 

#### **TECLA DE USO MULTIPLE:**

Se usa para llevar a cabo aumentos, cambios de porcentaje y recargos/descuentos automáticos.

15 

#### **TECLA DE CAMBIO DE SIGNO:**

Cambia el signo algebraico de un número (es decir, de positivo a negativo o de negativo a positivo).

16 

#### **TECLA DE INCLUSION DE IMPUESTO:**

Esta tecla se usa para hacer cálculos con el tipo de impuesto/descuento.

17 

### TECLA DE ALMACENAMIENTO:

Esta tecla se usa para almacenar el tipo de impuesto/descuento.

- Se puede almacenar un máximo de 4 dígitos (el punto decimal no cuenta como dígito).
- Para almacenar el tipo de descuento, apriete  primero.
- Sólo puede almacenar un tipo. Si introduce un nuevo tipo, borrará el anterior.

18 

### TECLA DE RECUPERACIÓN DE LA SEGUNDA MEMORIA

19 

### TECLA DE RECUPERACIÓN Y BORRADO DE LA SEGUNDA MEMORIA

20 **EXHIBICION**

Formato de la exhibición:

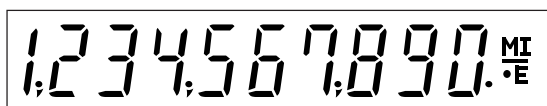

(CS-1194H)

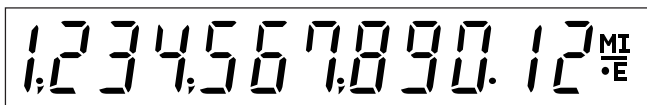

(CS-2194H)

**Símbolos:**

**M** : **Símbolo de la primera memoria**

Aparece cuando se ha almacenado un número en la primera memoria.

**I** : **Símbolo de la segunda memoria**

Aparece cuando se ha almacenado un número en la segunda memoria.

**-** : **Símbolo menos**

Aparece cuando el número es negativo.

**E** : **Símbolo de error**

Aparece cuando se detecta un error o se supera la capacidad.

**•** : **Símbolo del total global de la memoria**

Aparece cuando un número está en la memoria de total global.



## CAMBIO DE LA CINTA ENTINTADA

1. Quitar el rollo de papel de la calculadora. (Cortar el papel y sacarlo del mecanismo impresor usando )
2. **Colocar el interruptor de corriente en la posición marcada OFF.**  
**Asegurarse de que la rueda de impresión se haya detenido.**
3. Quitar la tapa de la impresora deslizando hacia la parte trasera de la calculadora. (Fig. 1)
4. Quitar la cinta usada.
5. Instalar la cinta nueva.
6. Con el lado negro de la cinta mirando para arriba, colocar uno de los carretes en el eje del carrete de la izquierda. (Fig. 2) Asegurarse de que el carrete esté firmemente colocado en su lugar.
7. Pasar la cinta por la parte exterior de las guías metálicas. (Fig. 3)
8. Estirar cualquier parte de cinta floja girando con la mano uno de los carretes.
9. Volver a poner la tapa de la impresora.
10. Volver a poner el rollo de papel.

Tapa de la impresora

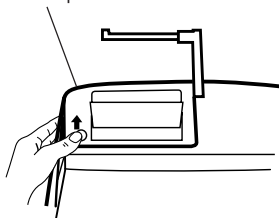

Fig. 1

Cinta entintada

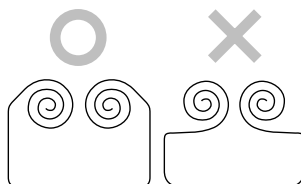

Fig. 2

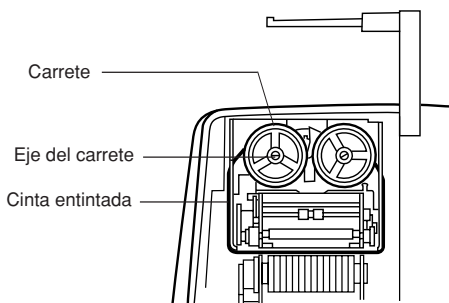

Fig. 3

## CAMBIO DEL ROLLO DEL PAPEL

1. Levantar el sujetador del papel. (Fig. 1)
2. Doblar la punta del rollo de papel de 3 a 5 cm (no la doble nunca de forma oblicua). (Fig. 2)
3. Introducir el rollo de papel desde el lado izquierdo del sujetador del papel y asegurarse de que el rollo de papel esté puesto en la dirección correcta (con el avance del papel desde el fondo) tal como muestra la figura. (Fig. 3)
4. Introducir la punta doblada en la abertura directamente por detrás del mecanismo de impresión. (Fig. 4)
5. Apretar la tecla de avance del papel haciendo avanzar el papel por debajo del borde del cortapapel. (Fig. 5)

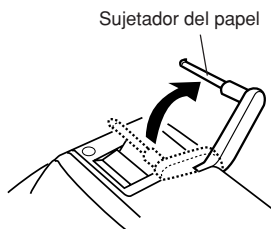

Fig. 1

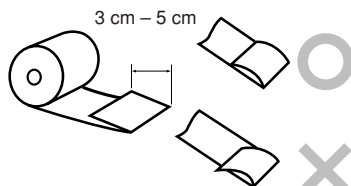

Fig. 2

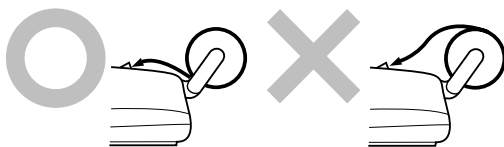

Fig. 3

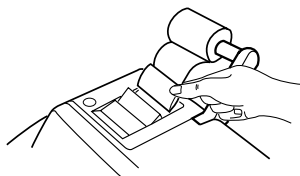

Fig. 4

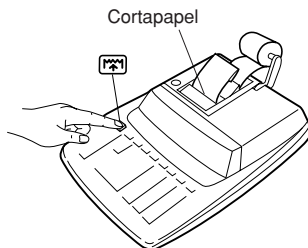

Fig. 5

NO TIRE DEL PAPEL HACIA ATRAS PORQUE SE PUEDE ESTROPEAR EL MECANISMO IMPRESOR.

## ERRORES

Existen diversos casos en los que ocurre un exceso de capacidad o una condición de error. Al producirse esto, aparecerá el símbolo de error “E” quedando electrónicamente bloqueadas todas las teclas. Los contenidos de la memoria, en el momento del error, quedan retenidos.

Si, al ocurrir el error, se visualiza el símbolo “0•E”, se deberá usar  $\boxed{*}$  para borrar la calculadora. Si se visualiza el símbolo “E” con cualquier número (excepto el cero), se puede borrar el error con  $\boxed{CE}$  o  $\boxed{\rightarrow}$  pudiéndose continuar el cálculo.

### Condiciones de error:

1. Entrada de más de 10 cifras o de 9 decimales. (CS-1194H)  
Entrada de más de 12 cifras o de 11 decimales. (CS-2194H)  
Este error puede borrarse con  $\boxed{CE}$  o  $\boxed{\rightarrow}$ .
2. Cuando la parte entera de un resultado excede las 10 cifras. (CS-1194H)  
Cuando la parte entera de un resultado excede las 12 cifras. (CS-2194H)
3. Cuando la parte entera de los contenidos de la memoria supera los 10 dígitos. (CS-1194H)  
(Ej.  $\boxed{*M}$  9999999999  $\boxed{M+}$  1  $\boxed{M+}$ )  
Cuando la parte entera de los contenidos de la memoria supera los 12 dígitos. (CS-2194H)  
(Ej.  $\boxed{*M}$  999999999999  $\boxed{M+}$  1  $\boxed{M+}$ )
4. Cuando se divide un número cualquiera por un divisor de cero. (Ej. 5  $\boxed{\div}$  0  $\boxed{\pm}$ )

## ESPECIFICACIONES TECNICAS

Capacidad de cálculo:	10 cifras (CS-1194H) 12 cifras (CS-2194H)
Fuente de alimentación:	CA: 120V, 60Hz
Cálculos:	Las cuatro operaciones aritméticas, multiplicaciones y divisiones por constante, cálculos de potencia, cálculos de recargos/descuentos, repetición de sumas y restas, cálculos recíprocos, cálculos con memoria, cálculos de cuenta de artículos, cálculos de aumento, impresión de no suma, cálculos de total global, etc.

### SECCION DE LA IMPRESORA

Impresora:	Impresora mecánica
Velocidad de impresión:	Aprox. 4,3 líneas/seg.
Papel de impresión:	57 mm ~ 58 mm de ancho, 80 mm de diámetro (máx.)
Temperatura:	0°C ~ 40°C
Potencia:	126 mA
Dimensiones:	250 mm (An.) × 345 mm (Pr.) × 78 mm (Al.)
Peso:	Aprox. 2,0 kg
Accesorios:	1 rollo de papel, 1 cinta entintada y manual de manejo

## CALCULATION EXAMPLES EXEMPLES DE CALCULS EJEMPLOS DE CALCULOS

1. Set the decimal selector as specified in each example.  
The rounding selector should be in the "5/4" position unless otherwise specified.
2. The grand total mode selector and the constant/add mode selector should be in the "•" position (off position) unless otherwise specified.
3. The print/item count mode selector should be in the "P" position unless otherwise specified.
4. If an error is made while entering a number, press **CE** or **→** and enter the correct number.
5. Negative values are printed with "-" symbol in red.

1. Régler le sélecteur de décimale tel que spécifié dans chaque exemple.  
Le sélecteur d'arrondi, doit être placé à la position "5/4" sauf indication contraire.
2. Le sélecteur de mode de grand total et de constante/d'addition, doivent être placés à la position "•" (position arrêt) sauf indication contraire.
3. Le sélecteur de mode d'impression, et le sélecteur de mode du compteur d'articles doivent être placés à la position "P" sauf indication contraire.
4. En cas d'erreur à l'introduction d'un nombre, appuyer sur **CE** ou **→** et introduire le nombre correct.
5. Les valeurs négatives sont accompagnées du symbole "-" imprimé en rouge.

1. Colocar el selector decimal según se especifica en cada ejemplo.  
El selector de redondeo debe estar en la posición "5/4" salvo que se especifica lo contrario.
2. El selector de modo de total global y selector del modo de constante/suma debe estar en la posición "•" (posición de desconexión) salvo que se especifica lo contrario.
3. El selector del modo de impresión/modo para contar artículos debe estar en la posición "P" salvo que se especifica lo contrario.
4. Si se hace un error al ingresar un número, apretar **CE** o **→** e ingresar el número correcto.
5. Los valores negativos se imprimen con el símbolo "-" en rojo.

Note: All totals and sub-totals may be used for further calculations. **RE-ENTER** the number into the calculator by using the **FUNCTION** key and continue the problem.

Remarque: Tous les totaux et les totaux partiels peuvent être utilisés pour des calculs ultérieurs. **RÉINTRODUIRE** le nombre dans la calculatrice en utilisant une touche de **FONCTION** et poursuivre le calcul.

Nota: Se pueden usar todos los totales y los totales parciales para cálculos posteriores. **VOLVER A INGRESAR** el número en la calculadora usando una tecla de **FUNCION** y continuar efectuando la operación.

EXAMPLE: EXEMPLE: EJEMPLO:

$$(123 + 456) \times 2 =$$

Selector Sélecteur Selector	Operation Opération Operación	Print Impression Impresión	Note Note Nota
F 6 4 3 2 1 0 	123 $\left[ \begin{smallmatrix} + \\ - \end{smallmatrix} \right]$	123.00 +	* { Re-entry of total Réintroduction du total Reingreso del total
	456 $\left[ \begin{smallmatrix} + \\ - \end{smallmatrix} \right]$	456.00 +	
	$\left[ * \right]$	579.00 *	
	$\left[ \times \right]$	* 579.00 ×	
	2 $\left[ \begin{smallmatrix} + \\ - \end{smallmatrix} \right]$	2. =	
		1.158.00 *	

### REPEAT ADDITION AND SUBTRACTION / ADDITION ET SOUSTRACTION SUCCESSIVES / REPETICION DE SUMAS Y RESTAS

$$123 + 123 + 123 + 456 - 100 - 100 =$$

Selector Sélecteur Selector (1)	Operation Opération Operación (2)	Display Affichage Exhibición (3)	Print Impression Impresión (4)
F 6 4 3 2 1 0 	123 $\left[ \begin{smallmatrix} + \\ - \end{smallmatrix} \right]$	123.	123. +
	$\left[ \begin{smallmatrix} + \\ - \end{smallmatrix} \right]$	246.	123. +
	$\left[ \begin{smallmatrix} + \\ - \end{smallmatrix} \right]$	369.	123. +
	456 $\left[ \begin{smallmatrix} + \\ - \end{smallmatrix} \right]$	825.	456. +
	100 $\left[ - = \right]$	725.	100. -
	$\left[ - = \right]$	625.	100. -
	$\left[ * \right]$	625.	625. *

**ADDITION AND SUBTRACTION WITH ADD MODE /  
ADDITION ET SOUSTRACTION AVEC MODE D'ADDITION /  
SUMA Y RESTA CON MODO DE SUMA**

$$12.45 + 16.24 + 19.35 - 5.21 =$$

(1)	(2) *1	(3)	(4)
F 6 4 3 2 1 0 	1245 $\frac{\pm}{\pm}$	12.45	12.45 +
	1624 $\frac{\pm}{\pm}$	28.69	16.24 +
	1935 $\frac{\pm}{\pm}$	48.04	19.35 +
K · A 	521 $\frac{-}{=}$	42.83	5.21 -
	$\frac{*}{*}$	42.83	42.83 *

\*1 :  $\frac{\cdot}{\cdot}$  was not used in the entries.

\*1 : La  $\frac{\cdot}{\cdot}$  n'a pas été utilisée dans les entrées.

\*1 : La  $\frac{\cdot}{\cdot}$  no ha sido usada en los registros.

**MIXED CALCULATIONS / CALCUL COMPLEXE / CALCULOS MIXTOS**

A.  $(10 + 2) \times 5 =$

(1)	(2)	(3)	(4)
F 6 4 3 2 1 0 	10 $\frac{\pm}{\pm}$	10.	10. +
	2 $\frac{\pm}{\pm}$	12.	2. +
	$\frac{\times}{\times}$		12. $\diamond$
	5 $\frac{\pm}{\pm}$	12.	12. $\times$
		60.	5. =
			60. *



B.  $5 \times 2 + 12 =$

(1)	(2)	(3)	(4)
F 6 4 3 2 1 0 	5 $\frac{\times}{\times}$	5.	5. $\times$
	2 $\frac{\pm}{\pm}$		2. =
			10. *
	$\frac{\pm}{\pm}$	10.	10. +
	12 $\frac{\pm}{\pm}$	10.	10. +
	$\frac{*}{*}$	22.	12. +
		22.	22. *

## CONSTANT / CALCULS AVEC CONSTANCE / CONSTANTES



A.  $62.35 \times 11.11 = \textcircled{1}$

$62.35 \times 22.22 = \textcircled{2}$

(1)	(2)	(3)	(4)
F643210  K • A 	62.35 $\times$ 11.11 $=$ 22.22 $\pm$	62.35  692.71  1,385.42	62.35 $\times$ 11.11 =K 692.71 * $\textcircled{1}$  22.22 =K 1.385.42 * $\textcircled{2}$



B.  $11.11 \div 77.77 = \textcircled{1}$

$22.22 \div 77.77 = \textcircled{2}$





(1)	(2)	(3)	(4)
F643210  K • A 	11.11 $\div$ 77.77 $=$ 22.22 $\pm$	11.11  0.143  0.286	11.11 $\div$ 77.77 =K 0.143 * $\textcircled{1}$  22.22 =K 0.286 * $\textcircled{2}$

## POWER / PUISSANCE / POTENCIA

A.  $5.25^2 =$

(1)	(2)	(3)	(4)
F643210  K • A 	5.25 $\times$ $=$ $\pm$	5.25  27.563	5.25 $\times$ 5.25 = 27.563 *

B.  $5^3 =$

(1)	(2)	(3)	(4)
F643210   K · A 	5 <input type="checkbox"/> × <input type="checkbox"/> ÷  <input type="checkbox"/> ÷	5.  25.  125.	5 · × 5 · =K 25 · *  25 · =K 125 · *
F643210   K · A 	5 <input type="checkbox"/> × <input type="checkbox"/> × <input type="checkbox"/> ÷	5. 25.  125.	5 · × 5 · × 5 · = 125 · *

## PERCENT / POURCENTAGE / PORCENTAJES

A.  $100 \times 25\% =$

(1)	(2)	(3)	(4)
F643210 	100 <input type="checkbox"/> × 25 <input type="checkbox"/> %	100.  25.00	100 · × 25 · % 25 · 00 *



B.  $123 \div 1368 = (\%)$

(1)	(2)	(3)	(4)
F643210 	123 <input type="checkbox"/> ÷ 1368 <input type="checkbox"/> %	123.  8.99	123 · ÷ 1 · 368 · % 8 · 99 *



## RECIPROCAL / INVERSES / RECIPROCOS

$$\frac{1}{7} =$$

(1)	(2)	(3)	(4)
$\uparrow 5/4 \downarrow$   F 6 4 3 2 1 0 	7 $\frac{1}{\square}$ $\frac{1}{\square}$ $\frac{1}{\square}$	7. 1.  0.14285714285 (0.142857142	$7 \cdot \div$ $7 \cdot \div$ $7 \cdot =$ 0.14285714285 *  0.142857142 * CS-1194H)

## ADD-ON AND DISCOUNT / MAJORATION ET RABAIS / RECARGOS Y DESCUENTOS

A. 5% add-on to 100. / Majoration de 5% de 100. / Un 5% de recargo sobre 100.

(1)	(2)	(3)	(4)
F 6 4 3 2 1 0 	100 $\times$ 5 $\text{MU}$	100.  105.00	$100 \cdot \times$ 5%  $5 \cdot 00$ { Increased amount Majoration Incremento  $105 \cdot 00 *$ { New amount Total majoré Nueva cantidad

B. 10% discount on 100. / Rabais de 10% sur 100. / Un 10% de descuento sobre 100.

(1)	(2)	(3)	(4)
F 6 4 3 2 1 0 	100 $\times$ 10 $\frac{+/-}{\square}$ $\text{MU}$	100.  90.00	$100 \cdot \times$ - 10%  - 10.00 { Discount Remise Descuento  $90 \cdot 00 *$ { Net amount Montant net Cantidad neta

## **MARKUP AND MARGIN / HAUSSE ET MARGE BÉNÉFICIAIRE / INCREMENTO PORCENTUAL Y MARGEN**

Markup and Profit Margin are both ways of calculating percent profit.

- Profit margin is percent profit vs. selling price.
- Markup is percent profit vs. cost.
- Cost is the cost.
- Sell is the selling price.
- GP is the gross profit.
- Mkup is the percent profit based on cost.
- Mrgn is the percent profit based on selling price.

Le calcul des majorations et des marges bénéficiaires sont deux façons de calculer un pourcentage de profit.

- La marge bénéficiaire est un pourcentage de profit par rapport au prix de vente.
- La majoration est un pourcentage de profit par rapport au prix d'achat.
- Cost est le prix d'achat.
- Sell est le prix de vente.
- GP est le bénéfice brut.
- Mkup est le bénéfice par rapport au coût.
- Mrgn est le bénéfice par rapport au prix de vente.

Tanto la función del incremento porcentual como la del margen de beneficio son formas de calcular el beneficio porcentual.

- El margen de beneficio es el beneficio porcentual con respecto al precio de venta.
- El incremento porcentual es el beneficio porcentual con respecto al coste.
- Cost es el coste.
- Sell es el precio de venta.
- GP es el beneficio bruto.
- Mkup es el beneficio porcentual basado en el coste.
- Mrgn es el beneficio porcentual basado en el precio de venta.

To find Pour trouver Para encontrar	Knowing Quand on connaît Sabien-do	Operation Opération Operación
Mrgn	Sell, Cost	Cost $\frac{-}{=}$ Sell $\frac{+}{=}$ <b>MU</b>
Mkup	Sell, Cost	Sell $\frac{+}{=}$ Cost $\frac{-}{=}$ <b>MU</b>
Sell	Cost, Mrgn	Cost $\frac{+}{+}$ Mrgn <b>MU</b>
Cost	Sell, Mrgn	Sell $\frac{\times}{\times}$ Mrgn $\frac{+/-}{+/-}$ <b>MU</b>
Sell	Cost, Mkup	Cost $\frac{\times}{\times}$ Mkup <b>MU</b>
Cost	Sell, Mkup	Sell $\frac{+}{+}$ Mkup $\frac{+/-}{+/-}$ <b>MU</b>

Ex. / Ex. / Ej.

Cost	Sell	GP	Mkup	Mrgn
\$200	\$250	\$50	25%	20%

(1)	(2)	(3)	(4)
F 6 4 3 2 1 0 	200 $\frac{+}{+}$ 20 <b>MU</b>	200.  50.00	200 $\div$ Cost 20 % M Mrgn 250.00 * Sell 50.00 GP GP

## PERCENT CHANGE / VARIATION EN POUR CENT / CAMBIO PORCENTUAL

- Calculate the dollar difference (a) and the percent change (b) between two yearly sales figures \$1,500 in one year and \$1,300 in the previous.
- Calculer la différence en dollars (a) et la variation en pour cent (b) entre deux prix. 1.500 \$ pour cette année et 1.300 \$ pour l'année précédente.
- Calcular la diferencia en dólares (a) y el cambio porcentual (b) entre dos cifras de ventas anuales, \$1.500 en un año y \$1.300 en el año anterior.

(1)	(2)	(3)	(4)
F 6 4 3 2 1 0 	1500 $\frac{+}{+}$ 1300 $\frac{-}{=}$ <b>MU</b>	1,500.00 200.00 15.38	1:500.00 + 1:300.00 - 200.00 * (a) 15.38 % C (b)

**PERCENT PRORATION /  
DISTRIBUTION PROPORTIONNELLE EN POURCENTAGE /  
DISTRIBUCION PROPORCIONAL DE PORCENTAJE**

- Calculate the percentage of each of the parts to the whole.
- Calculer le pourcentage que chaque article représente par rapport au tout.
- Calcular el porcentaje de cada artículo.

Expenses	%
Dépenses	
Gastos	
\$123	(a)
456	(b)
789	(c)
(D)	(d)

(1)	(2)	(3)	(4)
F 6 4 3 2 1 0 	$\boxed{\times M}$ *2		
	123 $\boxed{+}$	123.00	123.00 +
	456 $\boxed{+}$	579.00	456.00 +
	789 $\boxed{+}$	1,368.00	789.00 +
$\uparrow$ 5/4 $\downarrow$ 	123 $\boxed{MU}$		1,368.00 * (D)
			123 · F
			8.99 %P (a)
		8.99	
	$\boxed{M+}$	8.99 <sup>M</sup>	8.99 +M
	456 $\boxed{MU}$		456 · F
			33.33 %P (b)
		33.33 <sup>M</sup>	
	$\boxed{M+}$	33.33 <sup>M</sup>	33.33 +M
	789 $\boxed{MU}$		789 · F
			57.68 %P (c)
		57.68 <sup>M</sup>	
	$\boxed{M+}$	57.68 <sup>M</sup>	57.68 +M
	$\boxed{\diamond M}$		100.00 $\diamond M$ (d)
		100.00 <sup>M</sup>	
	$\boxed{\times M}$		100.00 *M
		100.00	

\*2 : Press  $\boxed{\times M}$  to clear the memory before starting a memory calculation.

\*2 : Effacer le contenu de la mémoire ( $\boxed{\times M}$ ) avant de procéder à un calcul avec mémoire.

\*2 : Apretar  $\boxed{\times M}$  para cancelar la memoria antes de empezar a efectuar un cálculo con memoria.

**ITEM COUNT CALCULATION /  
CALCUL DE COMPTE D'ARTICLES /  
CALCULO DE CUENTA DE ARTICULOS**

Bill No. Facture n° N° de factura	Number of bills Nbre de factures Cantidad de facturas	Amount Montant Importe
1	1	\$100.55
2	1	\$200.00
3	1	\$200.00
4	1	\$400.55
5	1	\$500.65
Total Total Total	(a)	(b)

(1)	(2)	(3)	(4)
F 6 4 3 2 1 0 	<input type="checkbox"/> * <input type="checkbox"/> ± 100.55		100.55 +
	<input type="checkbox"/> ± 200	100.55	200.00 +
	<input type="checkbox"/> ± 400.55	300.55	200.00 +
OFF • P P-IC 	<input type="checkbox"/> ± 500.65	500.55	400.55 +
	<input type="checkbox"/> ± 1,401.75	901.10	400.55 +
	<input type="checkbox"/> * 005	1,401.75	500.65 +
			1,401.75 * (a)
			(b)
		1,401.75	

## GRAND TOTAL / TOTAL GÉNÉRAL / TOTAL GLOBAL

$$100 + 200 + 300 = \textcircled{1}$$

$$+) 300 + 400 + 500 = \textcircled{2}$$

$$+) 500 - 600 + 700 = \textcircled{3}$$

Grand total / Total général / Total global  $\textcircled{4}$

(1)	(2)	(3)	(4)
F 6 4 3 2 1 0 	<b>GT</b> <input type="checkbox"/> * <input type="checkbox"/>		
	100 <input type="checkbox"/> ± <input type="checkbox"/>	100.	100·+
	200 <input type="checkbox"/> ± <input type="checkbox"/>	300.	200·+
	300 <input type="checkbox"/> ± <input type="checkbox"/>	600.	300·+
	<input type="checkbox"/> * <input type="checkbox"/>		600·* + $\textcircled{1}$
GT · 		600.·	
	300 <input type="checkbox"/> ± <input type="checkbox"/>	300.·	300·+
	400 <input type="checkbox"/> ± <input type="checkbox"/>	700.·	400·+
	500 <input type="checkbox"/> ± <input type="checkbox"/>	1,200.·	500·+
	<input type="checkbox"/> * <input type="checkbox"/>		1,200·* + $\textcircled{2}$
		1,200.·	
	500 <input type="checkbox"/> ± <input type="checkbox"/>	500.·	500·+
	600 <input type="checkbox"/> - = <input type="checkbox"/>	100.·-	600·-
	700 <input type="checkbox"/> ± <input type="checkbox"/>	600.·	700·+
	<input type="checkbox"/> * <input type="checkbox"/>		600·* + $\textcircled{3}$
		600.·	
	<b>GT</b> <input type="checkbox"/>		2,400·* G $\textcircled{4}$
		2,400.	

## MEMORY / MÉMOIRE / MEMORIA

A.  $46 \times 78 = \textcircled{1}$

$$+) 125 \div 5 = \textcircled{2}$$

$$-) 72 \times 8 = \textcircled{3}$$

Total / Total / Total  $\textcircled{4}$

(1)	(2)	(3)	(4)
F 6 4 3 2 1 0 	*3		
	46	46.	46 · ×
	78		78 · =
		3,588. <sup>M</sup>	3·588 · +M ①
	125	125. <sup>M</sup>	125 · ÷
	5		5 · =
		25. <sup>M</sup>	25 · +M ②
	72	72. <sup>M</sup>	72 · ×
	8		8 · =
		576. <sup>M</sup>	576 · -M ③
			3·037 · diamond M ④
		3,037. <sup>M</sup>	

B.  $(123 + 45) \times (456 - 89) =$

(1)	(2)	(3)	(4)
F 6 4 3 2 1 0 	*3		
	123	123. <sup>M</sup>	123 · +M
	45	45. <sup>M</sup>	45 · +M
GT • 	456	456. <sup>M</sup>	456 · +
	89	367. <sup>M</sup>	89 · -
			367 · diamond
		367. <sup>M</sup>	367 · ×
			168 · diamond M
		168. <sup>M</sup>	
			168 · =
		61,656. <sup>M</sup>	61·656 · *

\*3 : Press to clear the memory before starting a memory calculation.

\*3 : Effacer le contenu de la mémoire () avant de procéder à un calcul avec mémoire.

\*3 : Apretar para cancelar la memoria antes de empezar a efectuar un cálculo con memoria.

$$C. \frac{(874 + 557) \times (7 + 8)}{(1,746 + 876) \div (12 + 23)} =$$

(1)	(2)	(3)	(4)
F 6 4 3 2 1 0 [ ]	<b>*M</b> <b>*I</b> *4		
	12 <b>M+</b>	12. <sup>M</sup>	12. +M
	23 <b>M+</b>	23. <sup>M</sup>	23. +M
	1746 <b>±</b>	1,746. <sup>M</sup>	1,746. +
	876 <b>±</b>	2,622. <sup>M</sup>	876. +
	<b>+</b>		2,622. ◊
		2,622. <sup>M</sup>	2,622. ÷
	<b>*M</b>		35. *M
		35.	
	<b>M+</b>		35. =
		75. <sup>M</sup>	75. +M
	874 <b>+I</b>	874. <sup>MI</sup>	874. +I
	557 <b>+I</b>	557. <sup>MI</sup>	557. +I
	7 <b>±</b>	7. <sup>MI</sup>	7. +
	8 <b>±</b>	15. <sup>MI</sup>	8. +
	<b>×</b>		15. ◊
		15. <sup>MI</sup>	15. ×
	<b>◊I</b>		1,431. ◊I
		1,431. <sup>MI</sup>	
	<b>+</b>	21,465. <sup>MI</sup>	1,431. ÷
	<b>◊M</b>		75. ◊M
		75. <sup>MI</sup>	
	<b>±</b>		75. =
		286. <sup>MI</sup>	286. *
	<b>*M</b>		75. *M
		75. I	
	<b>*I</b>		1,431. *I
		1,431.	

\*4: Press **\*M** then **\*I** to clear the contents of the First and Second memories before starting the operation.

\*4: Avant de commencer les opérations, appuyer sur **\*M**, puis sur **\*I** pour effacer le contenu de la première et deuxième mémoires.

\*4: Antes de iniciar la operación, apriete **\*M** y luego **\*I** para borrar el contenido de la primera y de la segunda memoria.



## TAX RATE CALCULATIONS CALCULS DE TAXE CALCULOS CON EL TIPO DE IMPUESTO

EXAMPLE 1: Set a 5% tax rate. Calculate the total amount for adding a 5% tax to \$800.

EXEMPLE 1: Choisir une taxe de 5%. Calculer le montant d'un article à \$800 avec cette taxe.

EJEMPLO 1: Fijar el tipo de impuesto al 5%. Calcular la cantidad total resultante de añadir el impuesto del 5% a \$800.

(1)	(2)	(3)	(4)
F 6 4 3 2 1 0 <input style="width: 100px; height: 15px;" type="text"/>	5 <input type="checkbox"/> STR <input type="checkbox"/> TAX+	5.  5.000	TX 5-000 %
	800 <input type="checkbox"/> TAX+	840.	800- 40- TX 840-

EXAMPLE 2: Calculate the total amount for adding a 5% tax to the sum of \$500 and \$460.

EXEMPLE 2: Calculer la somme de deux articles, \$500 et \$460, avec cette taxe.

EJEMPLO 2: Calcular la cantidad total resultante de añadir el impuesto de 5% a la suma de \$500 y \$460.

(1)	(2)	(3)	(4)
F 6 4 3 2 1 0 <input style="width: 100px; height: 15px;" type="text"/>	500 <input type="checkbox"/> ± 460 <input type="checkbox"/> ± <input type="checkbox"/> TAX+	500. 960.  1,008.	500- + 460- + 960- * 48- TX 1-008-

EXAMPLE 3: Calculate the total amount for the sum of \$500 with tax already included and \$460 with 5% tax to be added.

EXEMPLE 3: Calculer la somme d'un article à \$500 taxe comprise et d'un article à \$460 auquel doit être ajoutée cette taxe.

EJEMPLO 3: Calcular la cantidad total resultante de sumar \$500 con el impuesto ya incluido y \$460 con el impuesto del 5% a añadir.

(1)	(2)	(3)	(4)
F 6 4 3 2 1 0 	500 $\boxed{+}$	500.	500· +
	460 $\boxed{TAX+}$		460·
			23· TX
			483·
		483.	
	$\boxed{+}$ $\boxed{*}$		483· +
			983· *
		983.	

## DISCOUNT RATE CALCULATION CALCUL D'UNE REMISE CALCULO CON EL TIPO DE DESCUENTO

EXAMPLE: Set an 8% discount rate. Calculate the final amount for an 8% discount on \$800.

EXEMPLE: Choisir une remise de 8%. Calculer le montant d'un article à \$800 après cette remise.

EJEMPLO: Fijar el tipo de descuento al 8%. Calcular la cantidad que se obtiene al hacer un descuento del 8% a \$800.

(1)	(2)	(3)	(4)
F 6 4 3 2 1 0 <input style="width: 100px; height: 15px;" type="text"/>	8 <input type="checkbox"/> +/- <input type="checkbox"/> STR <input type="checkbox"/> TAX+	8. -	TX - 8-000 %
		8.000 -	
	800 <input type="checkbox"/> TAX+	736.	- 800- 64- TX 736-

In U.S.A.:

**[www.sharp-usa.com](http://www.sharp-usa.com)**

For your convenience, Genuine Sharp Supplies, Accessories, and additional Sharp Products can be purchased from the Authorized Sharp Reseller where you purchased your product or on-line at:

**[www.sharpplace.com](http://www.sharpplace.com)**

**MEMO / BLOC-NOTES / NOTAS**

**MEMO / BLOC-NOTES / NOTAS**



**SHARP**  
**SHARP CORPORATION**