



Slim Flatbed Scanner

Refer to your Owner's Manual for complete instructions.

1. Locking/Unlocking the Scanner

Your scanner has a lock to protect it during shipment or while you move it.

- Slide the lock on the bottom of the scanner toward  to unlock it.
- To protect the scanner when you move or ship it, slide the lock toward .

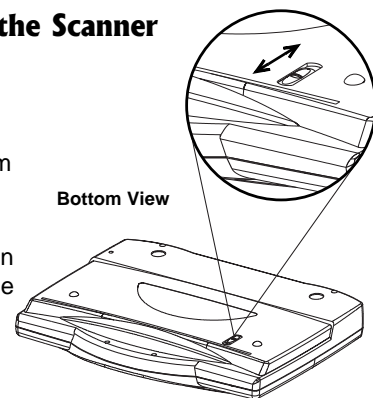

2. Connecting AC Power

Plug the supplied 12V, 1250 mA AC adapter's barrel plug into the power jack on the back of the scanner. Then plug the other end of the AC adapter into a standard AC outlet. The LED on the front of the scanner lights when the scanner is turned on.

3. Installing Software

- Start Windows (98 or later) and quit all other applications.
- Insert the software CD into your CD-ROM drive. The CD starts automatically. To manually start the CD, double click My Computer on your desktop, and then double click your CD drive.
- Follow the on-screen instructions to install the desired interfaces included on the CD.
- After you complete installing interfaces, Windows prompts you to restart your computer by clicking **Finish**.
- Insert the USB cable's flat plug into your computer's USB port and the square plug into the USB port on the back of the scanner. Windows (except Windows XP) automatically installs the software and the scanner icon appears on the taskbar.

See "Troubleshooting" in your Owner's Manual for help.

RadioShack Corporation
Fort Worth, Texas 76102

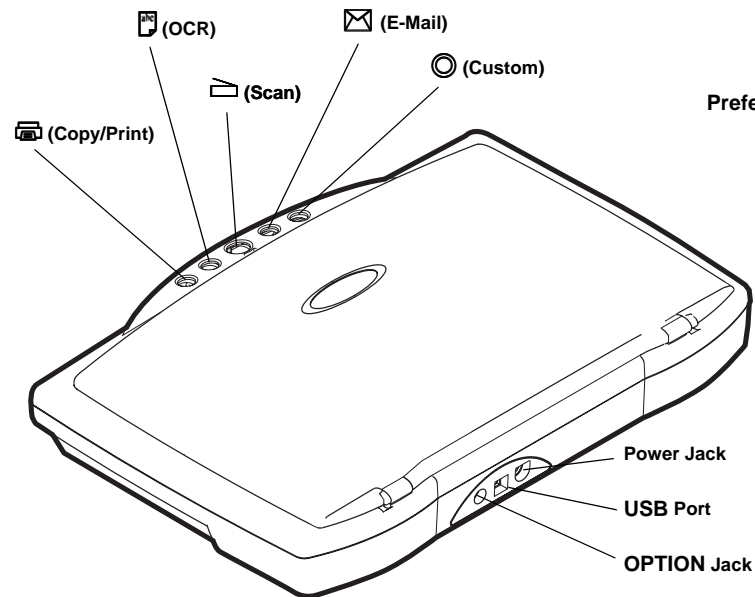



4. Initiate TWAIN to Find Scanner Commands

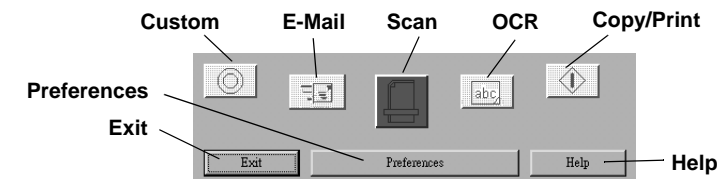

- Open your TWAIN application (see your Owner's Manual for a complete list of applications), select **File** and then **Select Source**. . . to open the *Select Source*. . . dialogue box. Select USB Scanner, and then click **Select**.
- Select **File** and then **Acquire** to open the *USB Scanner* window.
- Select **General** to adjust the scanning options and configuration.
- Under *Scan Page For*, select from the following options: Editing Text (OCR); Faxing, Filing or Copying; Black & White Photo; Color Document – Faster; Color Document – Better Quality; Custom. . . .
- Under *Scan Configuration*: select the *Mode*:, *Res*:, and *Size*:. . .
- Click **Preview** to preview changes and then **Scan** to finish scanning.



5. Scanning

- Place the paper face down on the scanner. Line up the corner of the paper with the arrow at the inside corner of the scanner's glass.
- Double-click  on the Windows taskbar. The on-screen scanner control panel appears.
- Click  on the on-screen scanner control panel, or press  on the scanner. The *USB Scanner* box appears.
- Under *Scanner Settings*, make any necessary adjustments under **General** and **Advanced**.
- Click **Scan** to scan the image.

6. Copying/Printing

- Place the paper face down on the scanner. Line up the corner of the paper with the arrow at the inside corner of the scanner's glass.
- Double-click  on the Windows taskbar. The on-screen scanner control panel appears.
- Click  on the on-screen scanner control panel or press  on the scanner's control pad for more than one second to scan the image.
- After the image is scanned, wait at least ten seconds for the *Print* box to appear.
- Set the *Picture Position* and the number of *Copies*:. . .
- To select your printer, click **Printer** and select the desired printer.
- Click **OK**. The document is sent to your printer.