



# Electrolux

**SPLIT TYPE**

## COOLING UNIT/CONDENSING UNIT

**MODEL**

**BCC-9I/BCC-9E  
BCC-12I/BCC-12E**



COOLING UNIT

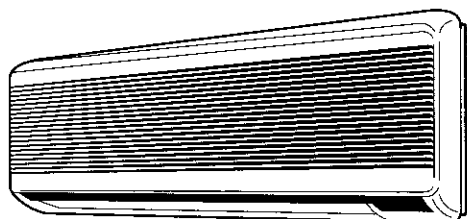

BCC-9I



COOLING UNIT

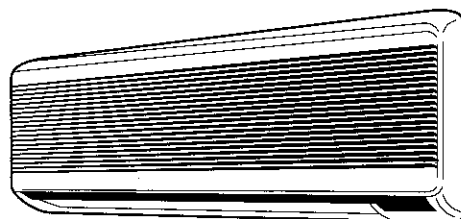

BCC-12I



CONDENSING UNIT

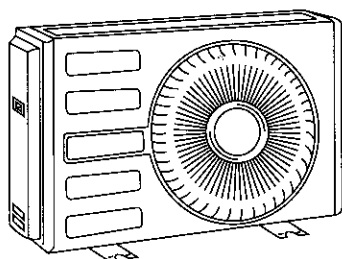

BCC-9E

CONDENSING UNIT

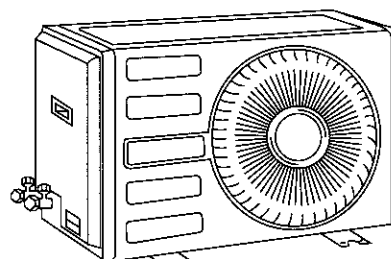

BCC-12E

**Instruction manual**

Page 1~18

To obtain the best performance and ensure years of trouble free use, please read this instruction manual completely.

**Mode d'emploi**

Page 19~36

Des performances optimales et un fonctionnement à long terme seront assurés en appliquant les présentes instructions après avoir entièrement lu ce mode d'emploi.

**Manuale di istruzioni**

Pag. 37~54

Per ottenere le migliori prestazioni e la massima affidabilità nel tempo, leggere con cura le seguenti istruzioni.

**Manual de instrucciones**

Página 55~72

Para obtener el mejor funcionamiento y asegurar años de uso libre de problemas, lea cuidadosamente este manual de instrucciones.

BCC-9I/BCC-9E

COOLING UNIT

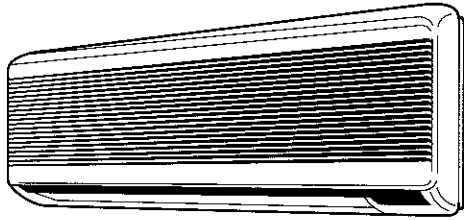

BCC-12I/BCC-12E

COOLING UNIT

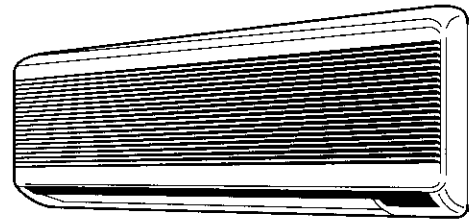

CONDENSING UNIT

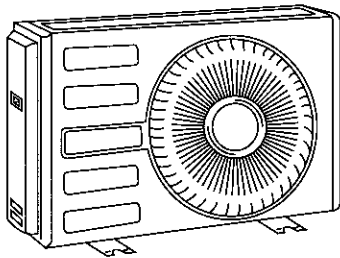

CONDENSING UNIT

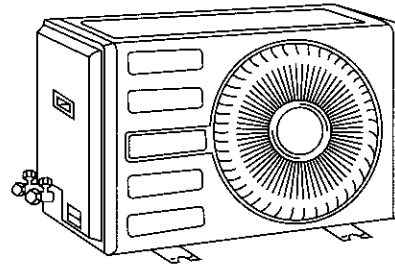

	WIDTH	HEIGHT	DEPTH
COOLING UNIT (BCC-9I)	815mm (32 <sup>1</sup> / <sub>16</sub> inch)	298mm (11 <sup>3</sup> / <sub>4</sub> inch)	179mm (7 <sup>1</sup> / <sub>16</sub> inch)
CONDENSING UNIT (BCC-9E)	820mm (32 <sup>1</sup> / <sub>4</sub> inch)	520mm (20 <sup>1</sup> / <sub>2</sub> inch)	220mm (8 <sup>1</sup> / <sub>16</sub> inch) [247mm (9 <sup>3</sup> / <sub>4</sub> inch)]
COOLING UNIT (BCC-12I)	815mm (32 <sup>1</sup> / <sub>16</sub> inch)	298mm (11 <sup>3</sup> / <sub>4</sub> inch)	179mm (7 <sup>1</sup> / <sub>16</sub> inch)
CONDENSING UNIT (BCC-12E)	820mm (32 <sup>1</sup> / <sub>4</sub> inch)	520mm (20 <sup>1</sup> / <sub>2</sub> inch)	280mm (11 <sup>1</sup> / <sub>32</sub> inch)

**NOTE**

- (1) Installation and the electrical connection of the units shall be performed only by authorized service personnel.
- (2) Only the outside unit part is splash-proofed.

## COOLING UNIT CONTROL PANEL

- Press the mark "PUSH" on the left and right sides of the suction grille to open it.
- After the work is finished, slightly lift the suction grille and then close it. Press the mark "PUSH" on the left and right sides of the suction grille to fix it securely.
- **TEMPORARY SWITCH** —————  
Use this switch to start and stop when the remote controller does not work. Normally do not use this button.
- **POWER SWITCH** —————

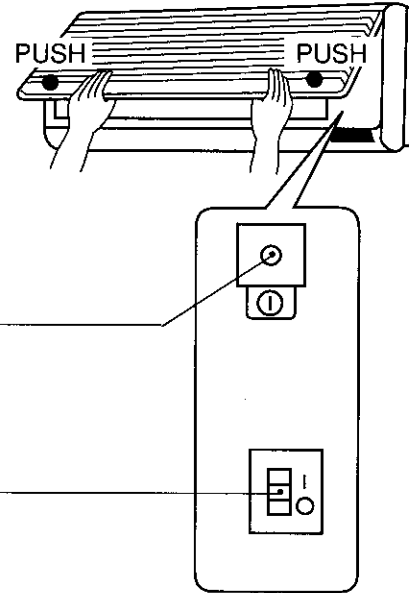

## COOLING UNIT INDICATORS

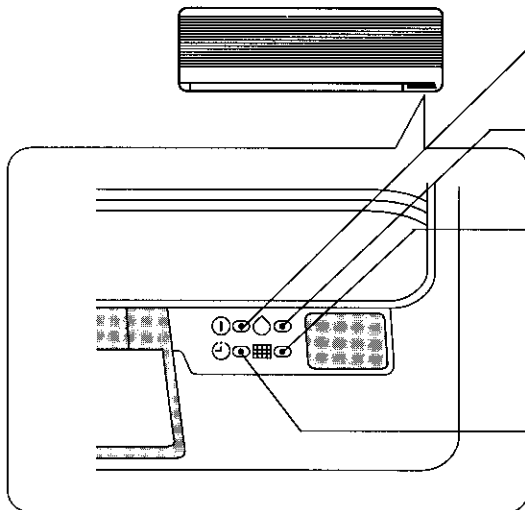

- **OPERATION lamp**  
This lamp lights during operation.
- **DRY lamp**  
This lamp lights during dehumidifying operation.
- **FILTER lamp**  
When the device is operated for a total of about 100 hours, the FILTER lamp lights to indicate that it is time to clean the filter. The lamp goes out when the FILTER button on the remote controller is pressed.
- **TIMER lamp**  
This lamp lights when the timer is working.

# NAMES AND FUNCTIONS OF EACH PART

## REMOTE CONTROLLER

This controls the operation of the cooling unit. The range of control is about 7 meters. If indoor lighting is controlled electronically, the range of control may be shorter.

This unit can be fixed on a wall using the fixture provided. Before fixing it, make sure the cooling unit can be controlled from the remote controller.

### TIMER selector

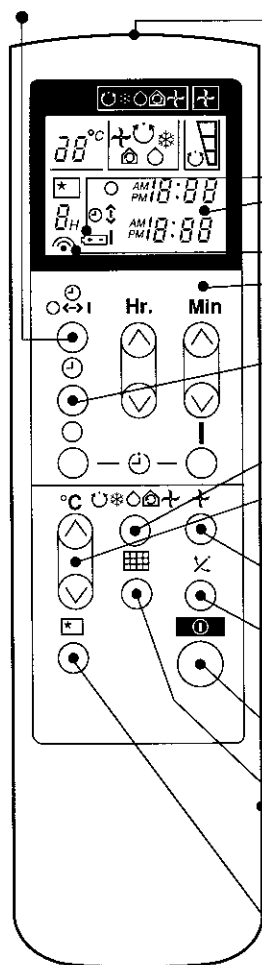

- **Signal emitting window/transmission sign**  
Point this window toward the cooling unit when controlling it. The transmission sign blinks when a signal is sent.
- **Battery warning sign**  
Replace the battery when this is blinking.
- **Display**  
This indicates the room temperature selected, current time, timer status, function and intensity of circulation selected.
- **Timer controls**  
Use these buttons to set the timer.
- **TIME button**  
Use this button to set and check the current time.
- **FUNCTION selector**  
Use this button to select the operating mode. Every time you press it, the mode will change from ☺ (AUTO) to ❄ (COOL) to ○ (DEHUMIDIFY) to ☺ (CIRCULATE) and to ✚ (FAN) cyclically.
- **TEMPERATURE button**  
Use these buttons to raise or lower the temperature setting. (Keep pressed, and the value will change more quickly.)
- **FAN SPEED selector**  
This determines the fan speed. Every time you press this button, the intensity of circulation will change from ☺ (AUTO) to 🌀 (HI) to 🌀 (MED) to 🌀 (LOW) (during the ✚ (FAN) mode, from 🌀 HI to 🌀 MED to 🌀 LOW).
- **AUTO SWING button**  
Controls the angle of the horizontal air deflector.
- **START/STOP button**  
Press this button to start operation. Press it again to stop operation.
- **FILTER button**  
Press this button when you have cleaned the filter. About 100 hours after this, the 🌀 (FILTER lamp) will light to indicate that it is the time to clean the filter again.
- **Battery compartment (at the back)**  
The batteries are in here.
- **SLEEP button**  
Use this button to set the sleep timer.

☺	AUTO
❄	COOL
○	DEHUMIDIFY
☺	CIRCULATE
✚	FAN
🌀	FAN SPEED HI MED LOW
☑	SLEEPING
○	STOP (CANCEL)
I	START (RESERVE)
Ⓜ	START/STOP
⌚	TIME
⌚	TIMER SET
⌚	TIMER SELECTOR
🌀	FILTER RESET
✚	AUTO SWING

### Precautions for Use

- Do not put the remote controller in the following places.
  - In direct sunlight.
  - In the vicinity of a heater.
- Handle the remote controller carefully. Do not drop it on floor, and protect it from water.
- Once the condensing unit stops, it will not restart for about 3 minutes (unless you turn the power switch off and on or unplug the power cord and plug it in again).  
This is to protect the device and does not indicate a failure.
- If you press the FUNCTION selector button during operation, the device may stop for about 3 minutes for protection.

# AUTOMATIC OPERATION

The device will automatically determine the operation mode of COOL, or DEHUMIDIFY depending on the initial room temperature. The selected mode of operation will not change when the room temperature varies.

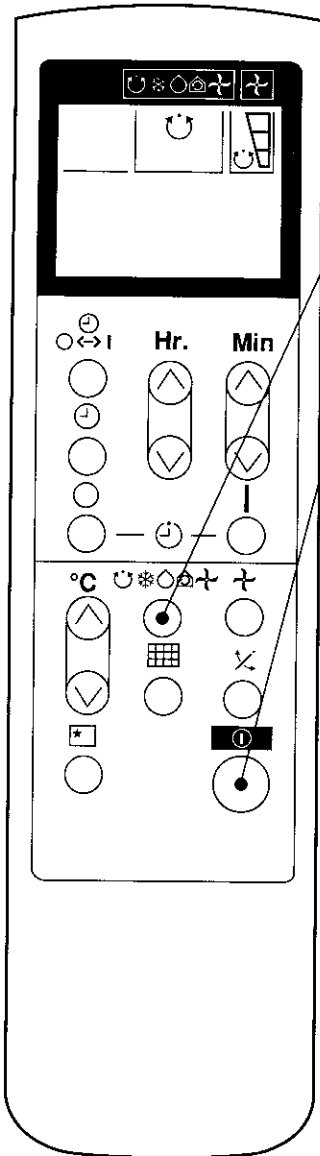

1 Press the FUNCTION selector so that the display indicates the (AUTO) mode of operation.

- When AUTO is selected, the device will automatically determine the mode of operation COOL or DEHUMIDIFY depending on the current room temperature.
- The FAN SPEED selector does not work at this time: the FAN SPEED is AUTO during COOL and LOW during DEHUMIDIFY.

**START STOP** Press the (START/STOP) button. Operation starts with a beep. Press the button again to stop operation.

■ As the settings are stored in memory in the remote controller, you only have to press the (START/STOP) button next time.

You can raise or lower the temperature setting as necessary by maximum of 3°C.

Press the TEMPERATURE button and the temperature setting will change by 1°C each time.

- The preset temperature and the actual room temperature may vary somewhat depending on environmental conditions.
- The display does not indicate the preset temperature in the AUTO mode. If you change the setting, the cooling unit will produce a beep.

## ■ Condition of Automatic Operation

Initial room temperature (approx.)	Function	Temperature setting	FAN SPEED
Over 27°C	➔ COOL	27°C	HI at start, MED or LOW after the preset temperature is reached
Below 27°C	➔ DEHUMIDIFY	Slightly lower than the room temperature	LOW

# COOLING OPERATION

The maximum and minimum operating temperatures of the hot and cold sides should be as below: If humidity is very high (over 80%) at indoor, some dew may form on the air outlet grille of the cooling unit.

		Minimum	Maximum
Indoor	Dry bulb °C	21	32
	Wet bulb °C	15	23
Outdoor	Dry bulb °C	21	43
	Wet bulb °C	15	26

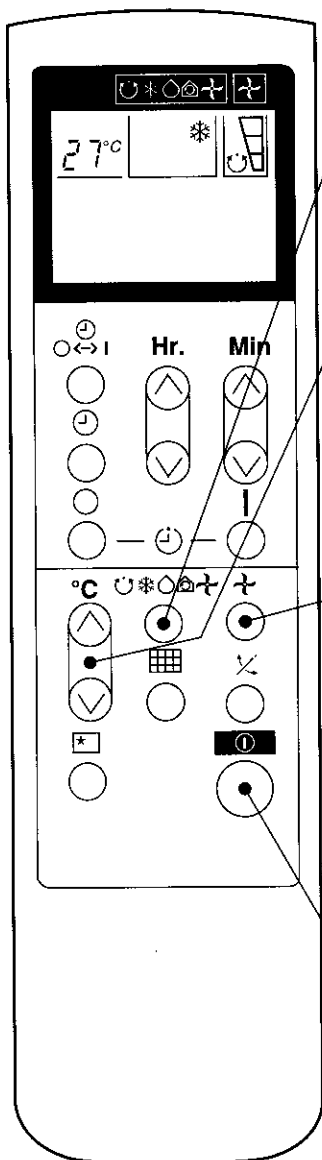

**1**

Press the FUNCTION selector so that the display indicates \* (COOL).

**2**

Set the desired room temperature with the TEMPERATURE button (the display indicates the setting).

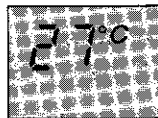

The range of 25-28°C is recommended as the room temperature for cooling. If the temperature setting is 27, the room temperature will be controlled at around 27°C.

The temperature setting and the actual room temperature may vary somewhat depending on environmental conditions.

**3**

Set the desired FAN SPEED with the FAN SPEED button (the display indicates the setting).

☺ (AUTO): The FAN SPEED is HI at first and varies to MED or LOW automatically when the preset temperature is reached.

(HI) : Maximum operation.

(MED) : Quiet operation.

(LOW) : Quietest operation.

**START/STOP**

Press the Ⓛ (START/STOP) button. Cooling operation starts with a beep. Press the button again to stop operation.

The cooling function does not start if the temperature setting is higher than the current room temperature (even though the Ⓛ (OPERATION) lamp lights). The cooling function will start as soon as you set the temperature below the current room temperature.

■ As the settings are stored in memory in the remote controller, you only have to press the Ⓛ (START/STOP) button next time.

## DEHUMIDIFYING OPERATION

Use the device for dehumidifying when the room temperature is over 16°C. When it is under 15°C, the dehumidifying function will not work.

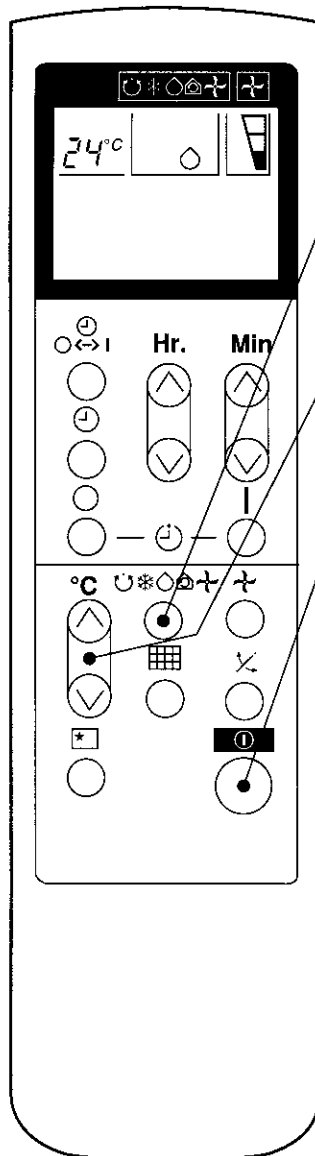

1

Press the FUNCTION selector so that the display indicates ◊ (DEHUMIDIFY).  
The FAN SPEED is set at LOW automatically.  
The FAN SPEED button does not work.

2

Set the desired room temperature with the TEMPERATURE button (the display indicates the setting).

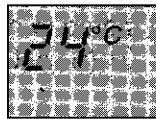

The range of 20-26°C is recommended as the room temperature for dehumidifying.

START  
STOP

Press the Ⓚ (START/STOP) button. Dehumidifying operation starts with a beep. Press the button again to stop operation.

- As the settings are stored in memory in the remote controller, you only have to press the Ⓚ (START/STOP) button next time.

### ■ Dehumidifying Function

When the room temperature is higher than the setting temperature: The device will dehumidify the room, reducing the room temperature to the preset level.

When the room temperature is lower than the temperature setting: Dehumidifying will be performed with the room temperature set slightly lower than the current room temperature, whatever the temperature setting is. The function will stop (the cooling unit will stop emitting air) as soon as the room temperature becomes lower than the setting temperature.

## CIRCULATING OPERATION

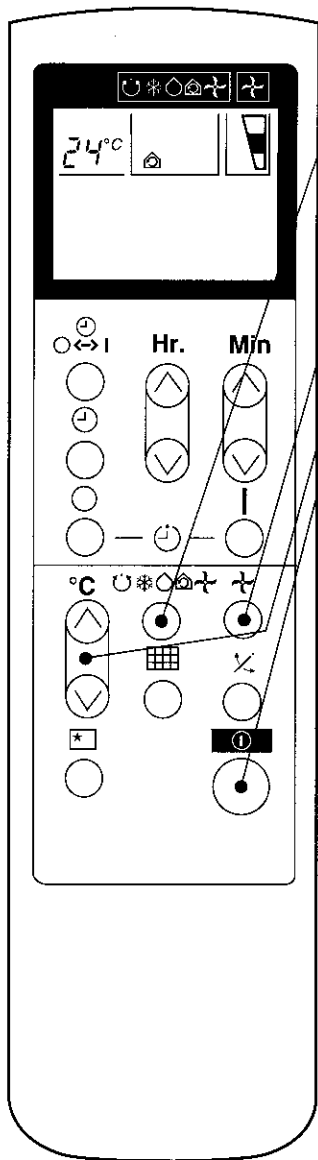

1

Press the FUNCTION selector so that the display indicates  (CIRCULATE).

2

Press the FAN SPEED button and select the desired FAN SPEED (the display indicates your choice).

3

Press the temperature control button to set to the desired temperature.

**START  
STOP**

Press the  (START/STOP) button. Circulating operation starts with a beep. Press the button again to stop operation.

- As the settings are stored in memory in the remote controller, you only have to press the  (START/STOP) button next time.

When the room temperature is higher than the temperature set by the thermostat, only the fan operates to circulate the upper hotter air downwards. This makes temperature distribution of the room even at heating.

This operation is useful in winter when using other heating equipment.



## FAN OPERATION

You can use the device simply as an air circulator. Use this function to dry the interior of the cooling unit at the end of summer.

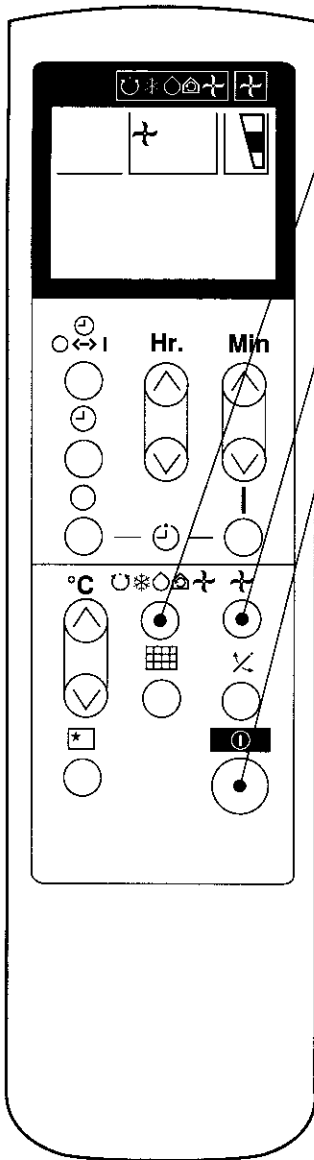

1

Press the FUNCTION selector so that the display indicates  (FAN).

2

Press the FAN SPEED button and select the desired FAN SPEED (the display indicates your choice).

**START  
STOP**

Press the  (START/STOP) button. Fan operation starts with a beep. Press the button again to stop operation.

# HOW TO SET THE TIMER

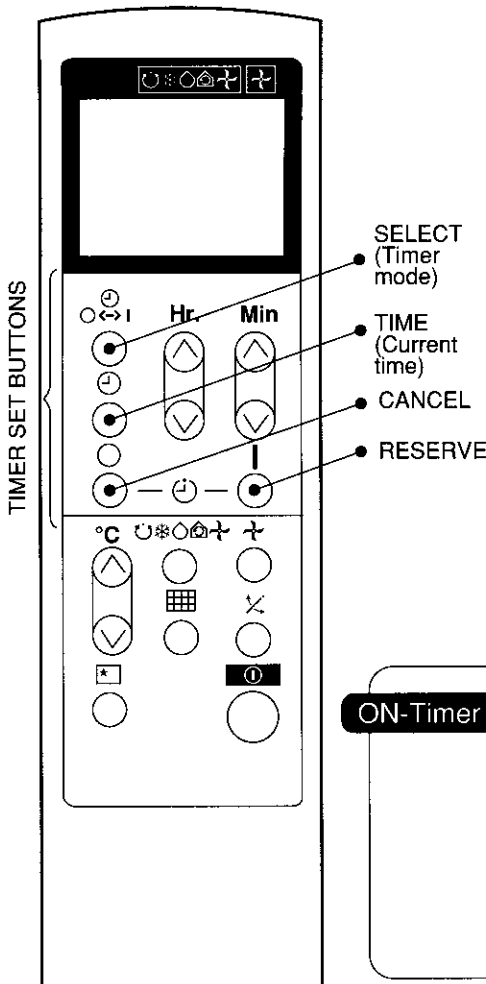

## Setting the Current Time

After you change the batteries;



**1** Press the (TIME) button.

## OFF-Timer

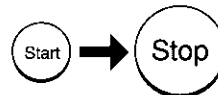

You can set the device to turn off at the preset time.

**1** Press the (SELECT) button until the (OFF) mark blinks on the display.

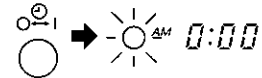

## ON-Timer

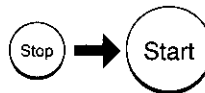

**1** Press the (SELECT) button until the (ON) mark blinks on the display.

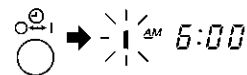

## ON/OFF-Timer



**1** Press the (SELECT) button so that the (OFF) mark blinks and the (ON) mark lights in the display.

**2** Set the turn-off time with the HOURS and MINUTES buttons.

**3** Press the (SELECT) button so that the (OFF) mark lights and the (ON) mark blinks.

- The device will turn on (off) and off (on) at the designated times.
- The switching occurs first at the preset time that comes earlier.
- The arrow mark appearing on the display indicates the sequence of switching operations.

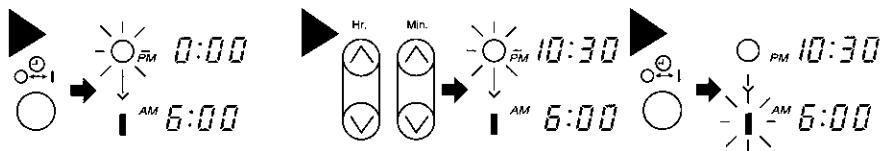

## How to Cancel Reservation

Point the signal window of the remote controller toward the cooling unit, and press the (CANCEL) button.  
The (RESERVED) sign goes out with a beep and the (TIMER) lamp turns off on the cooling unit.

### NOTE

You can set only one of the OFF-timer, ON-timer and ON/OFF-timer.

**2** Set the current time with the HOURS and MINUTES buttons.

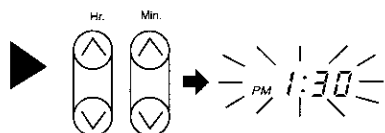

Example: The current time is 1:30 p.m.

**3** Press the TIME button again. The time indication starts lighting instead of blinking.

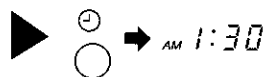

- The time indication will disappear automatically in 10 seconds.
- To check the current time setting, press the TIME button twice.

The setting of the current time is now complete.

**2** Set the turn-off time with the HOURS and MINUTES buttons.

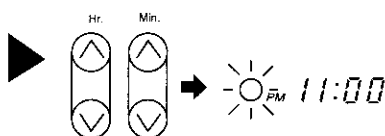

**3** Point the signal window of the remote controller toward the cooling unit, and press the I (RESERVE) button. The ○ (OFF) mark starts lighting instead of blinking and the sign ⊖ (RESERVED) lights. A beep occurs and the ⊖ (TIMER) lamp lights on the cooling unit.



Example: The device will turn off at 11:00p.m.

The setting of turn-off time is now complete.

**2** Set the turn-on time with the HOURS and MINUTES buttons.

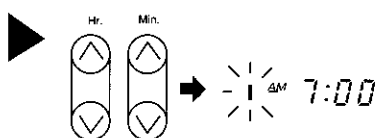

**3** Point the signal window of the remote controller toward the cooling unit, and press the I (RESERVE) button. The I (ON) mark starts lighting instead of blinking and the ⊖ (RESERVED) sign lights. A beep occurs and the ⊖ (TIMER) lamp lights on the cooling unit.

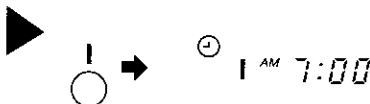

Example:  
The device will simply turn on at 7:00 a.m.  
(Circulating and fan operation)  
The device will automatically turn on and control to the temperature set at 7:00 a.m.  
(Cooling and dehumidifying operation)

The setting of the turn-on time is now complete.

**4** Set the turn-on time with the HOURS and MINUTES buttons.

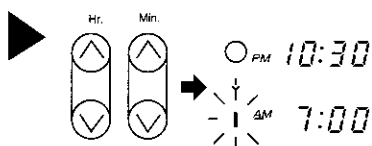

**5** Point the signal window of the remote controller toward the cooling unit, and press the I (RESERVE) button. The I (ON) mark starts lighting instead of blinking and the ⊖ (RESERVED) sign lights. A beep occurs and the ⊖ (TIMER) lamp lights on the cooling unit.

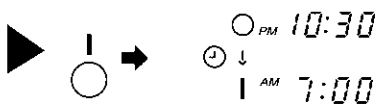

Example:  
The device will turn off at 10:30 p.m. and then turn on at 7:00 a.m.  
(Circulating and fan operation)  
The device will turn off at 10:30 p.m., and then automatically turn on and control to the temperature set at 7:00 a.m.  
(Cooling and dehumidifying operation)

The settings of the turn-on/off times are now complete.

- The timer may be used in three ways: off-timer, on-timer, and on/off (off/on)-timer. Set the current time at first because it serves as a reference.
- As the time settings are stored in memory in the remote controller, you only have to press the I (RESERVE) button in order to use the same settings next time.
- ON-Timer  
The device will turn on before the preset time.  
Temperature will be reached at the designated time.  
Operation starting time varies depending on the conditions such as room temperature, set room temperature, etc.

## HOW TO SET THE SLEEP TIMER

Set the current time at first if it is not set before (see the pages for setting the current time). Press the  (SLEEP) button, and the display changes as shown below.

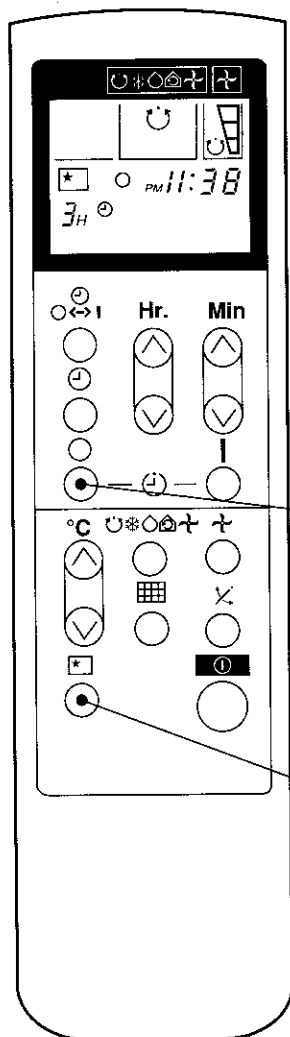

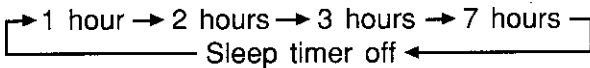
Mode	Indication
Sleep timer	

**Sleep Timer:** The device will continue working for the designated number of hours and then turn off. Point the signal window of the remote controller toward the cooling unit, and press the SLEEP button. The timer information will be displayed on the remote controller. The TIMER lamp lights with a beep in the cooling unit. When the sleep timer is set, the display indicates the turn-off time.



 <sup>AM</sup> 2:38

Example: If you set 3 hours sleep time at 11:38 p.m., the turn-off time is 2:38 a.m.

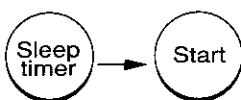



The device will be turned off by the sleep timer and turned on by on-timer.

**1** Set the ON-timer.

**2** Press the  (SLEEP) button and set the sleep timer.



 <sup>AM</sup> 1:38  
↓  
 <sup>AM</sup> 6:00

For example:

In this case, the device will turn off after 2 hours (at 1:38 a.m.) and starts at 6:00 next morning.

### How to Cancel Reservation

Point the signal window of the remote controller toward the cooling unit, and press the  (CANCEL) button.

The  (RESERVED) sign goes out with a beep and the  (TIMER) lamp turns off on the cooling unit.

#### NOTE

If you set the sleep timer after the off-timer or on/off-timer is set, the sleep timer becomes effective instead of the off- or on/off-timer.

### Explanation of the sleep timer

The device will control the fan speed and room temperature automatically so as to be quiet and good for people's health.

You can set the sleep timer to turn off after 1, 2, 3 or 7 hours. The fan speed and room temperature will be controlled as shown below.

#### Operation with the sleep timer

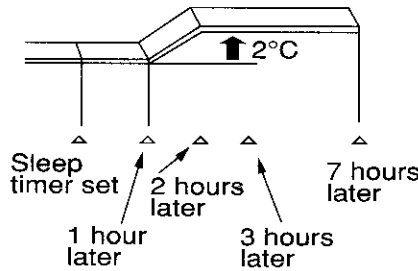
Function	Operation
Cooling and dehumidifying “❄️” “💧”	<p>The room temperature will be controlled 2°C above the setting temperature 1 hour after the setting of the sleep timer. The FAN SPEED will be set to LOW an hour later automatically.</p> 
Fan “✚”	<p>The settings of room temperature and circulation are not varied.</p>

## ADJUSTING THE AIR DEFLECTORS

**1** Adjustment of the conditioned air in the upward and downward directions.

According to "Dehumidifying" or "Cooling" operation, the horizontal air deflector is automatically set to the proper angle suitable for each operation. The deflector can be swung up and down and also set to the desired angle using the "⌵ (AUTO SWING)" button. (If the angle of the deflector is changed, it will not return to the auto-set position after operations start unless the operation mode is switched.)

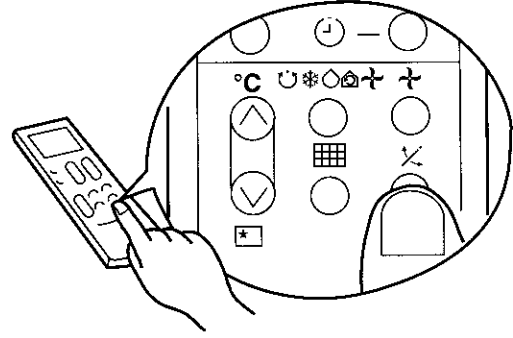

- If the "⌵ (AUTO SWING)" button is pressed once, the horizontal air deflector swings up and down. If the button is pressed again, the deflector stops in its current position. Several seconds (about 12 seconds) may be required before the deflector starts to move.
- If the deflector is not used at fixed angle, set the horizontal air deflectors within range of mark on the side plate for "Dehumidifying" and "Cooling" operations.
- Swinging the air deflector is effective to reduce unevenness of the temperature in the room.
- In "Cooling" operation, do not keep the horizontal air deflector swinging for a long time. Some dew may form on the horizontal air deflector and some dew drops may fall from it.
- When the "⌵ (AUTO SWING)" button is pressed while the operation is stopped, the horizontal air deflector moves and stops at the position where the air outlet closes.
- When the auto swing operation is performed, if the horizontal air deflector is moved manually, the swinging range may drift. However, it will return to the original operation range after a short time.

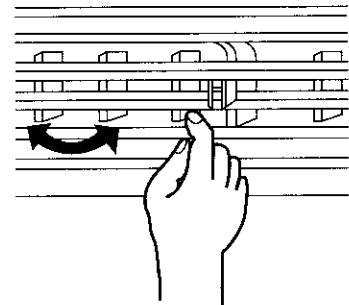
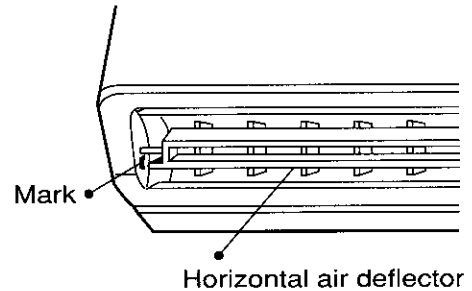

**2** Adjustment of the conditioned air to the left and right.

Hold the vertical air deflector as shown in the figure and adjust the conditioned air to the left and right.

# HOW TO EXCHANGE THE BATTERIES IN THE REMOTE CONTROLLER

Replace the batteries when the  (battery) mark in the indicator of remote controller lights.

**1** Remove the cover as shown in the figure and take out the old batteries.



**2** Install the new batteries.  
The direction of the batteries should match the marks in the case.



**3** Press the "⊕ (TIME)" button three times.

## ▲ CAUTION

1. Do not use new and old batteries, or different kinds of batteries together.
2. Take out the batteries when you do not use the remote controller for 2 or 3 months.
3. The batteries must be of the LR03 type.

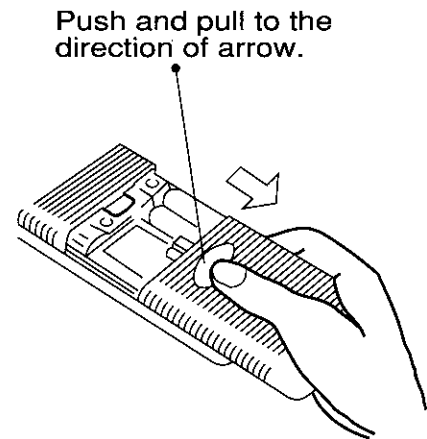

## TEMPORARY SWITCH

Use the temporary switch when operation can not be done with the remote controller.

1. By pressing the temporary switch, the operation is done in previously set operation mode.  
When the operation is done using the temporary switch after the power source is turned off and is turned on again, the operation is done in automatic mode.
2. When the operation is stopped or when the operation is done with the remote controller again, press the temporary switch once again.

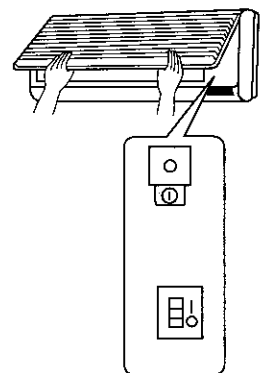

## POWER SWITCH

When you do not use the room air conditioner, set the power switch to "OFF".

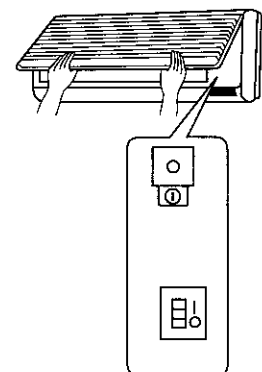

# MAINTENANCE

## ▲ CAUTION

Before the cleaning, stop operation and disconnect the power supply.

## Air filter

Clean the air filter, as it removes dust inside the room. It should be washed when the  (FILTER) lamp lights. In case the air filter is full of dust, the air flow will decrease and the cooling capacity will be reduced. Further, noise may occur. Be sure to clean the filter following the procedure below.

## Procedure

**1** Remove the filter.

- Press the mark "PUSH" on the left and right sides of the suction grille.
- Pull the front cover forward (Until the fixed position).
- Slightly lift the filter and release the claws (2 locations) at the lower part of the front cover and remove the filter from the lower side.

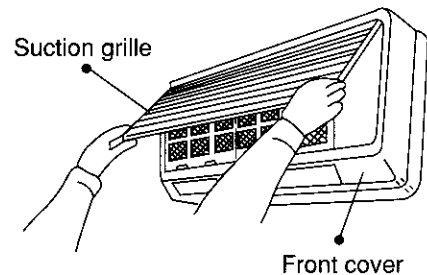

**2** Remove dust from the filter using a vacuum-cleaner.

If there is too much dust, use neutral detergent. After using neutral detergent, wash with clean water and dry in the shade.

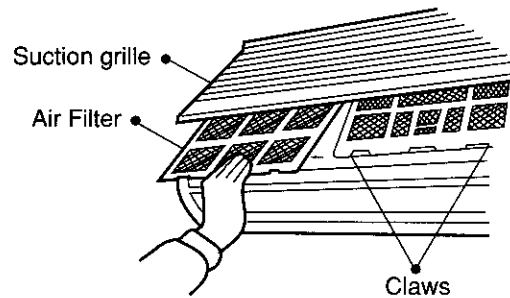

**3** Install the filters. (Set them with "FRONT" mark facing front.)

Slightly lift the suction grille and close as original state.

(Press the mark "PUSH" at the left and right sides of the suction grille to fix it securely.)

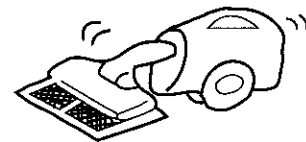

## ▲ CAUTION

- Do not wash with hot water at more than 40°C. The filter may shrink.
- When washing it, shake off moisture completely and dry it in the shade; do not expose it directly to the sun. The filter may shrink.
- Do not operate the air conditioner with the filter removed. Dust may enter the air conditioner and cause trouble.



## CLEANING OF FRONT COVER, ETC.

1. The front cover easily becomes dirty.  
Wipe it with a soft dry cloth.
2. When it is excessively dirty, wipe with a soft cloth soaked in lukewarm water or neutral detergent. Then wipe thoroughly with a soft dry cloth.
3. Never use hot water (above 50°C), benzine, gasoline, acid, thinner or a brush, because they will damage the plastic surface and the coating.

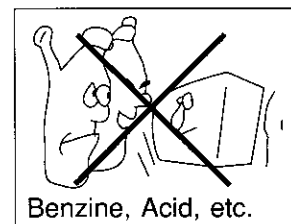
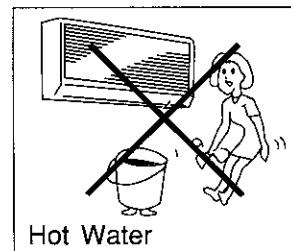

ENGLISH

## MAINTENANCE AT BEGINNING OF LONG OFF PERIOD

1. Running the unit setting the operation mode to  $\rightarrow$  (FAN) and the fan speed to HI for about half a day on a fine day, and dry the whole of the unit.

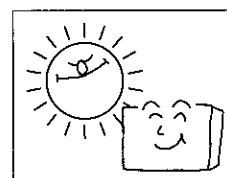

## WHEN ASKING FOR SERVICE, CHECK THE FOLLOWING POINTS.

### WHEN IT DOES NOT OPERATE

1. Is the fuse all right?
2. Is the voltage extremely high or low?
3. Is the power switch "ON"?

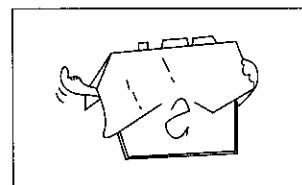
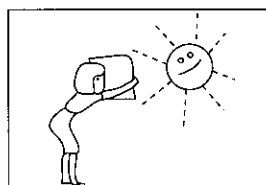

### WHEN IT DOES NOT COOL WELL

1. Is the air filter blocked with dust?
2. Does sunlight fall directly on the condensing unit?
3. Is the air flow of the condensing unit obstructed?
4. Are the doors or windows opened, or is there any source of heat in the room?
5. Is the set temperature suitable?

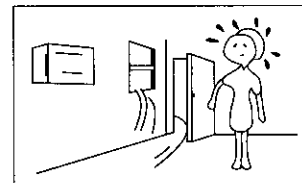
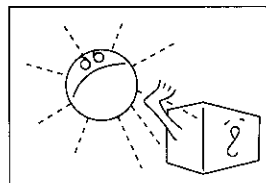

### Notes

- In quiet operation or stopping the running, the following phenomena may occasionally occur, but they are not abnormal for the operation.
  - (1) Slight flowing noise of refrigerant in the refrigerating cycle.
  - (2) Slight rubbing noise from the fan casing which is cooled and then gradually warmed as operation stops.
- The odor will possibly be emitted from the room air conditioner because the various odor, emitted by smoke, foodstuffs, cosmetics and so on, sticks to it. So please clean the air filter and the evaporator at the beginning of the season to reduce the odor.

This appliance complies with E. E. C. directive No. 87/308 relative to radio perturbation and interference suppression.