

DRD212NW

USER'S MANUAL

What is the DSS System? ...3

Using the Program Guide...6

Using the Menu System ...10

Using On-line Help14

Features16

Setting Up the Remote.....36

Connecting the Receiver ..38

Warranty Information52

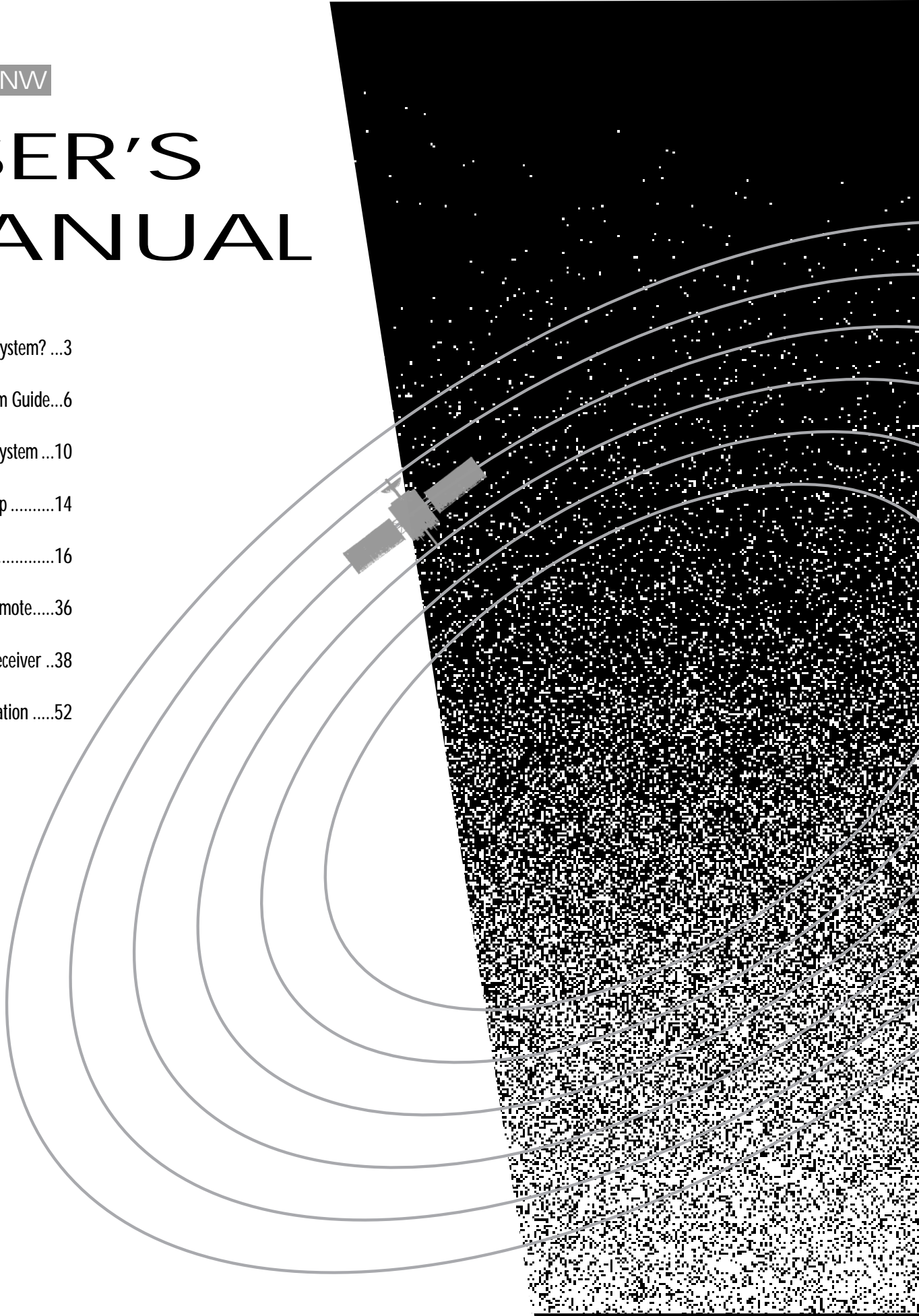

SATELLITE RECEIVER

Safety Information

WARNING

To reduce fire or shock hazard, do not expose this receiver to rain or moisture.

WARNING

RISK OF ELECTRIC SHOCK
DO NOT OPEN

TO REDUCE THE RISK OF ELECTRIC SHOCK, DO NOT REMOVE COVER (OR BACK). NO USER SERVICEABLE PARTS INSIDE. REFER SERVICING TO QUALIFIED SERVICE PERSONNEL.



This symbol indicates “dangerous voltage” inside the product that presents a risk of electric shock or personal injury.



This symbol indicates important instructions accompanying the product.

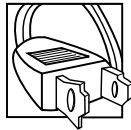

To prevent electric shock, match wide blade of plug to slot, fully insert.

Pour éviter les chocs électriques, introduire la lame la plus large de la fiche dans la borne correspondante de la prise et pousser jusqu'au fond.

Cautions

Do not stack electronic components or other objects on top of the DSS Receiver. The slots on top of the receiver must be left uncovered to allow proper airflow to the unit. Blocking the airflow to the unit could impair performance or damage your receiver and other components.

Do not stack the DSS receiver on top of a “hot component” such as an audio power amplifier.

Do not defeat the safety feature of the plug. The wire blade fits into the wall socket only one way. If you need an extension cord, make sure it matches the plug of the receiver/decoder.

FCC Regulations state that unauthorized changes or modifications to this equipment may void the user's authority to operate it.

Note to Cable TV Installer:

This reminder is provided to call your attention to Article 820-40 of the National Electrical Code (Section 54 of the Canadian Electrical Code, Part 1) which provides guidelines for proper grounding and, in particular, specifies that the cable ground shall be connected to the grounding system of the building as close to the point of cable entry as practical.

Note to Satellite Dish Installer:

This reminder is provided to call your attention to Article 810 and in particular article 810-15 of the National Electrical Code which covers proper installation and grounding of television receiving equipment as well as to article 820-40 of the National Electrical Code which specifies that the satellite dish cable ground shall be connected to the grounding system of the building as close to the point of cable entry as practical.

Section 1: Using Your DSS System

What is the DSS System?	3
Using this Manual	4
Important Note about This DSS User's Manual	4
The Only Rule: Point and Select	5
What is Point and Select?	5
Using the Program Guide	6
Bringing Up the Program Guide.....	6
Exiting from the Program Guide.....	7
Getting Around in the Program Guide	7
Sorting the Program Guide	8
Using the Menu System	10
Menus	10
Display Screens	11
Commonly Used Buttons	13
Using On-line Help	14
Auto Help	14
Help Buttons	14
Menu Help.....	15
Major Features	16
Pay-Per-View Programs	16
Purchasing and Viewing	16
Reviewing PPV Purchases.....	18
Canceling PPV Programs	18
The DSS Mailbox	18
How To Tell When You Have Mail	19
Checking Your Mail	19
Mailbox Size	20
Setting Up Channel Lists	20
Building Your Channel Lists	21
Using Your Channel Lists.....	21
Choosing Your Channel Lists.....	22
Changing Your Channel Lists	23
Setting Rating, Spending, and Channel Limits.....	23
Setting the Ratings Limit.....	24
Setting the Spending Limit	24
Setting the Channel Limit	24
Locking the System	25
Unlocking the System	26
Session Unlock	26
Unlocked v. Locked v. Session Unlock	26

Alternate Audio Programs	27
ALT AUD Remote Button.....	27
Alternate Audio Display Screen.....	28
Other Features	29
Picture Size	29
System Test.....	29
New Access Card Setup	29
Parts of the DSS System.....	30
World View	30
Home View	31
Back Panel.....	32
Front Panel	33
Remote Buttons.....	34

Section 2: Setting Up Your DSS System

Setting up the Remote.....	36
Installing the Batteries.....	36
Programming the Remote	36
TV Codes	37
Connecting Your DSS receiver to Your TV	38
Jacks and Cables	38
Choosing a Connection.....	39
Connection A (Best Picture and Sound Quality).....	40
Connection B Very Good Picture and Sound Quality)	42
Connection C (Good Picture and Sound Quality).....	44
Connection D (Good Picture and Sound Quality)	46
Glossary	48
Menu Tree.....	50
Troubleshooting	51
Warranty Information	52
FCC Regulations.....	56
Accessories	59
Index	Inside Back Cover

What is the DSS System?

You've purchased the DSS™ Digital Satellite System, so you already know a lot of the great things it offers. You know that the DSS system uses the latest satellite technology to deliver television programming to your home. And you know that programs are broadcast in digital format, so the quality of the picture and audio rivals that of laser discs and CDs. You know the dish is small—18 inches—and that it often can be installed in a matter of hours. (See the *DSS Satellite Dish Antenna Installer Guide* for specific information.)

Those are the some of the things you probably know about the DSS system. But what about the things you don't know? For instance...

- **The DSS system works like your TV.** Pick up the DSS remote and push the DSS button—a program comes on the TV. Press the Channel Up/Down buttons to scan through the channels. Press the number keys to go directly to a channel.
- There is an **on-screen Program Guide**. The Program Guide lists the available programs and times. It is designed to help you select regular programs and pay-per-view events. You can also sort the Guide to list only specific types of programs. You can select Sports, for example, and your guide will show current and upcoming sports programs only. Or movies. Or news.
- There is the **DSS on-screen Menu System** that allows you to customize your system: set up your system, build channel lists, preview coming attractions, set spending limits, and receive mail from your program providers.
- There are three types of **On-line Help** to assist you in learning to use the DSS system: Auto Help, Help buttons, and the Help menu. (See *Using On-line Help*, page 14.)

Using this Manual

The purpose of this User's Manual is to give you the information you'll need to begin using the DSS system. The manual is divided into two parts:

Section 1: Using Your DSS System contains the information and the steps necessary to learn how one simple rule—Point and Select—allows you to use every feature in the Program Guide and the menu system. (See *The Only Rule: Point and Select* on page 5.)

Section 2: Setting Up Your DSS System contains chapters of information that may be necessary if you move, change, or add components in your DSS system. This section includes the steps necessary to:

- Set up your DSS remote control
- Connect the DSS receiver to your TV and other components
- Order DSS accessories

Important Note about This User's Manual

This manual assumes that your DSS system has been installed, meaning:

1. The DSS satellite dish has been installed, correctly pointed at the satellite, and connected to your DSS receiver.
2. The DSS receiver is connected to your television and telephone line.
3. The access card is installed in your DSS receiver.

Note: Your access card has been matched to your receiver, and should already be installed when you take the receiver out of the packing box. The access card should only be taken out of the DSS receiver when you are issued a new card by your programming providers.

4. The DSS TV Universal Remote Control has batteries and has been programmed to control both your DSS receiver and your TV (if your TV is remote-controllable).

If your system has not been installed, refer to the satellite dish *Installer's Guide* for information regarding proper installation. Then, refer to the section, *Connecting Your DSS Receiver*, in this manual. See your dealer for specific information regarding professional installation or the purchase of a Self-Installer's Kit.

The Only Rule: Point and Select

You only need to know one rule to use the DSS system: Point and Select. Once you master this rule, you can use any part of the Program Guide or the menu system.

What is Point and Select?

The Point and Select method has two steps.

1. Point

You point by pressing the arrow keys on the remote or front panel. Pressing the arrows keys (referred to as the “arrows”) moves the on-screen highlight to different items in the Program Guide and the menu screens. Pressing an arrow once moves the highlight one space in the direction of the arrow.

For example, to point down (that is, to move the highlight towards the bottom of the screen), press the down arrow. To point right, press the right arrow.

2. Select

Once you have pointed to an item on the screen, select it by pressing the SELECT/DISPLAY button on the remote or front panel (called SELECT in this manual). Selecting an item tells the menu system to go ahead and make the change you have indicated.

For example, the instructions in the User’s Manual might tell you to: Point to the Help button and press SELECT.

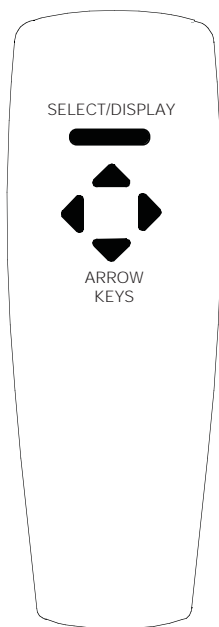

Now that you know how to use Point and Select, you can use any part of the DSS system, beginning with the Program Guide.

Using the Program Guide

The Program Guide is designed to help you select regular programs and pay-per-view events by listing all the programs and program times that are available to you. (The content of the Program Guide is dependent on your program providers, and may not look exactly like the Program Guide menu, below.)

Using the Program Guide is easy as long as you remember the simple point-and-select method. Point to items on the screen by pressing the arrow keys on the remote or front panel. Then, press SELECT to tune to that program.

Bringing Up the Program Guide

There are two ways to bring up the Program Guide

1. Press the GUIDE button on the remote.

or

2. Press MENU to bring up the Main menu. Then, select Program Guide from the Main menu.

Program Guide						7:35PM
Channel	7:30PM	8:00PM	8:30PM	9:00PM	9:30PM	
122						
123						
124						
125						
126						
▼	Movies	Sports	Other	All	Exit	

If you select a future program, you are given program details. If you choose a pay-per-view event, a second screen allows you to buy the program, find out more information, or return to the Guide.

Note: Any time you want to remove the Program Guide or a menu from the screen, press CLEAR on the remote.

Exiting from the Program Guide

There are three ways to exit from the Program Guide:

- Point to the Exit button on the bottom of the Program Guide and press SELECT
- or
- Point to a channel and press SELECT
- or
- Press CLEAR on the remote.

The Program Guide leaves the screen and you are returned to regular program viewing. If you have selected a pay-per-view program, a display screen allows you to purchase the selected program.

Getting Around in the Program Guide

This section describes how to change channels and move around the Program Guide.

Changing Channels with the number keys (0-9)

You can point quickly to any channel in the Program Guide by entering the channel number with the number keys (0-9). For example, to point to the first listing for Channel 128, press the numbers 1-2-8 on the remote. To point to Channel 2, press 0-0-2.

Scrolling

The programs that you see on the TV screen make up one section—or page—of the total Program Guide. You can scroll to other sections using the arrows: point to other times with the left and right arrows; point to other channels with the up and down arrows.

CHAN ▲ / ▼

If you want to scroll up or down through the Program Guide faster, press the Channel Up/Down buttons. The highlight block scrolls five lines—or channels—at a time. This is called “paging.”

Selecting Special Guides

Your programming providers may make available special types of guides that can be accessed from the main Program Guide. To select a special guide, go into the Program Guide and press MENU.

Sorting the Program Guide

There are six on-screen choices—called “buttons”— at the bottom of the Program Guide: ▼ (down arrow), Movies, Sports, Other, All, and Exit. The down arrow and the Exit button allow you to see other parts of the guide or remove the guide from the screen.

Program Guide						7:35PM
Channel	7:30PM	8:00PM	8:30PM	9:00PM	9:30PM	
122						
123						
124						
125						
126						
▼	Movies	Sports	Other	All	Exit	



▼ Button

The ▼ button allows you to scroll down through other channels in the Program Guide. Once you point to the ▼ button, the Program Guide scrolls down one channel at a time each time you press SELECT.

Note: You can also scroll down the Program Guide by continuing to press the down arrow on the remote control or front panel.



Exit Button

The Exit button allows you to leave the Program Guide and return to regular TV viewing.

Using the Sorting Buttons

The remaining buttons at the bottom of the Program Guide are called “sorting buttons.” These buttons allow you to simplify the Program Guide to show specific types of information only, such as movies, or sports.

Program Guide					
	7:35PM				
Channel	7:30PM	8:00PM	8:30PM	9:00PM	9:30PM
122					
123					
124					
125					
126					
▼	Movies	Sports	Other	All	Exit

Your program providers may periodically change the names and functions of the sorting buttons to reflect different ways of simplifying the Program Guide.

Movies

Movies Button

Simplifies your Program Guide to list movies only.

After selecting Movies, point to the Theme button that appears and press SELECT to sort the Program Guide to list specific types of movies, such as comedies or thrillers.

Sports

Sports Button

Simplifies your Program guide to list sporting events only.

After selecting Sports, point to the Theme button that appears and press SELECT to sort the Program Guide to highlight specific types of sports, such as basketball or soccer.

Other

Other Button

Allows you choose from a list of sorting topics. Once you have selected a sorting topic from the list, your Program Guide will be simplified to show only that type of program.

After selecting a topic, a Theme button may appear in the place of the Other button. Press SELECT to sort the Program Guide to highlight specific types of that topic.

All

All Button

Resets the Program Guide to show all available channels and listings.

Themes

Themes Button

Once you have simplified your Program Guide using one of the sorting buttons, you may be able to further sort the Program Guide to show sub-topics (“themes”). For example, you could simplify your Program Guide to show “baseball” under the Sports sorting button, or “comedies” under Movies.

Using the Menu System

There are two parts to the menu system: menus and display screens.

Menus

Menus are lists of choices. The first menu is called the Main menu. To bring up the Main menu, press MENU on the remote.



Any time you want to get out of a menu or the Program Guide, press CLEAR on the remote.

There are two ways to make a choice in a menu:

- Point to the choice and press SELECT.
- or
- Press a corresponding number key on the remote.

Example 1: To choose Mailbox from the Main menu using the point and select method:

1. Press MENU on the remote to bring up the Main menu.

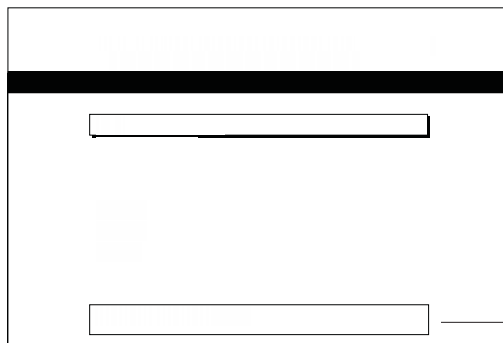

When using the point-and-select method in a menu, a Help message describing the highlighted item appears at the bottom of the screen.

2. Point to Mailbox.
3. Press SELECT on the remote. The Mailbox display screen comes up.

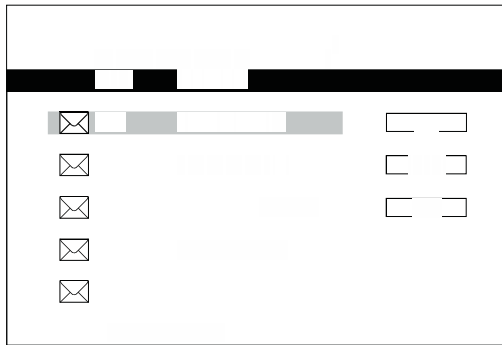

Example 2: To choose Help from the Main menu using number keys:

1. Press MENU on the remote to bring up the Main menu.
2. Press 6 on the remote. The Help menu screen comes up.

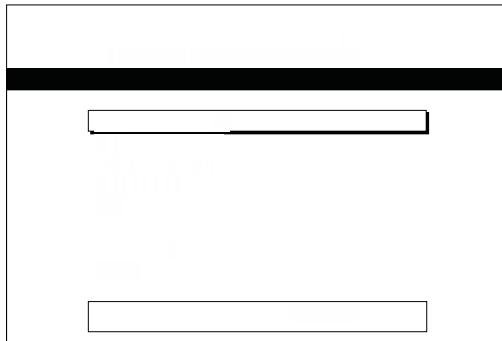

Display Screens

As you can see from the previous examples, some menu choices bring up other menus. The rest of the choices bring up *display screens*. A display screen is the place you do the actual work in the menu system. Each display screen has a work area, as well as a number of on-screen push buttons.

Example: To use a display screen to set up your channel lists:

1. Press MENU to bring up the Main menu.
2. Point to Options and press SELECT.
3. Point to Locks, Limits, and Channel Lists and press SELECT.

4. Point to Channel Limits and Lists and press SELECT.

The Channel Limits and Lists display screen comes up.

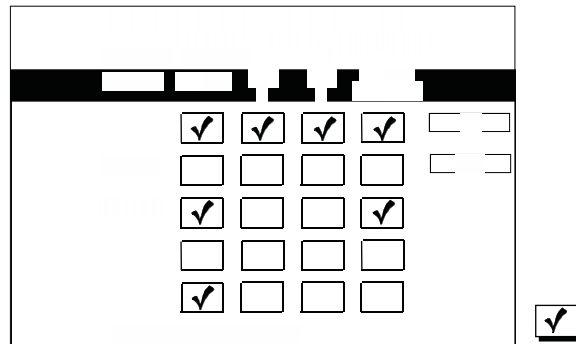

5. Point to a check box on the display screen.
6. Press SELECT to add the channel to the channel list.
7. Press SELECT again to remove the channel from the list.
8. To save your changes and leave the display screen, point to OK and press SELECT.

For more information about building channel lists, see *Setting Up Your Channel Lists*, page 20.

Commonly Used Push Buttons

You will find on most display screens one or more “push” buttons that allow you to save your changes, leave the screen, or get Help information.

OK

OK Buttons

You’ll see an OK button in many of the display screens. Any time you point to an OK button on a display screen and press SELECT, your changes are saved and you leave that display screen.

Exit

Exit Buttons

Any time you point to an Exit button on a display screen and press SELECT, you are returned to the previous display screen or menu.

Help

Help Buttons

Any time you point to a Help button on a display screen and press SELECT, you are given information about the screen you are using.

Using On-line Help

On-line Help is available for all of the menus and display screens. The DSS System provides three types of Help: Auto Help, Help buttons, and Menu Help.

Auto Help

Most menus contain a short description of the menu you are using.

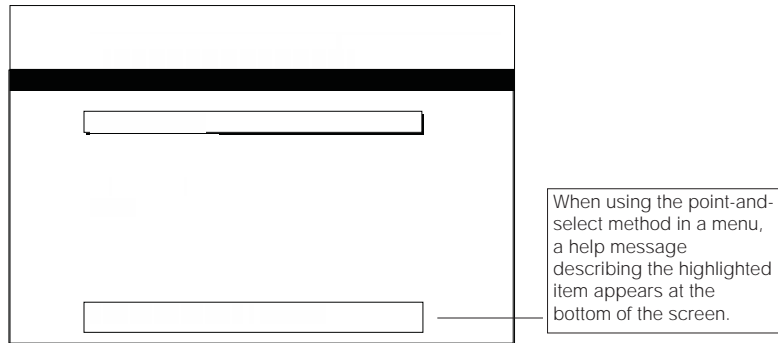

Help Buttons

Help buttons appear in many display screens. To see information about the display screen you are using, point to the Help button and press SELECT. Press SELECT to remove the message from the screen.

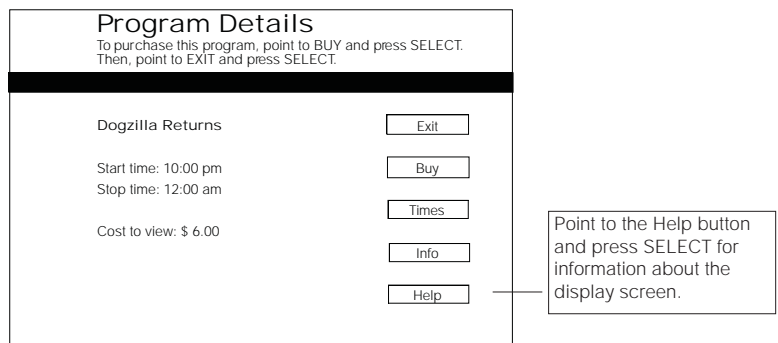

Menu Help

Select **Help** from the Main menu to choose from a list of on-line Help topics. Then, use your remote control to find out about the specific parts of the DSS system.

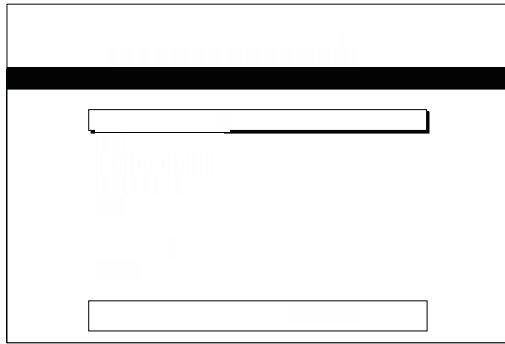

Point to **Remote Control** and press **SELECT** to see an on-screen display of the remote control. Point to the different remote buttons to see a brief description of the highlighted button. Press **MENU** to return to the Help menu.

Point to **Program Guide** and press **SELECT** to see a screen-by-screen overview of the Program Guide features. Press **SELECT** to continue through each of the Help screens. Press **MENU** to return to the Help menu.

Point to **Menu System** and press **SELECT** to see a screen-by-screen overview of the DSS menu system. Press **SELECT** to continue through each of the Help screens. Press **MENU** to return to the Help menu.

Point to **Program Types** and press **SELECT** to see a screen-by-screen overview of the different kinds of programming available to you. Press **SELECT** to continue through each of the Help screens. Press **MENU** to return to the Help menu.

Point to **Front Panel** and press **SELECT** to see an on-screen display of the DSS receiver front panel. Point to the different front panel features to see a brief description of the highlighted feature. Press **MENU** to return to the Help menu.

Point to **Back Panel** and press **SELECT** to see an on-screen display of the DSS receiver back panel. Point to the different back panel features to see a brief description of the highlighted feature. Press **MENU** to return to the Help menu.

Point to **Glossary** and press **SELECT** to see a list of common DSS and TV terms. Point to various glossary items to see brief descriptions. Press **MENU** to return to the Help menu.

Major Features

The DSS menu system offers you access to more features than a single user's manual can explain in detail, so you should spend some time exploring the different menus and display screens. Some of the major features in the DSS system allow you to:

- Select pay-per-view programs and coming attractions
- Receive on-screen messages from your program provider
- Customize the DSS system with channel lists that you build yourself
- Set spending and rating limits—then lock the system to enforce those limits.

Pay-Per-View Programs

Pay-per-view programs (PPV) are programs that you purchase—like a movie ticket—on an event-by-event basis. For instance, there might be a specific channel that runs nothing but previews for movies. After previewing the movie, you can purchase it or find out more details about it. PPV programs can also be found in the Program Guide.

Purchasing and Viewing

There are several ways to purchase PPV movies and events:

- Tune to a PPV program while pressing CHAN ▲/▼ to scan through the channel lists
- or
- Select a PPV program in the Program Guide
- or
- Select a coming attraction from the Attractions menu.

Using the Program Guide for PPV Programs

The Program Details screen comes up if you point to a PPV program in the Program Guide and press SELECT.

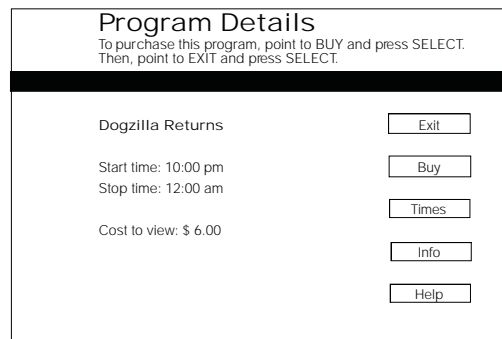

Using the Attractions Menu for PPV Programs

Your program providers may offer future programming events not currently listed in your Program Guide. These events are called “coming attractions,” and can be previewed and purchased through the Attractions menu.

1. Press MENU to bring up the Main menu.

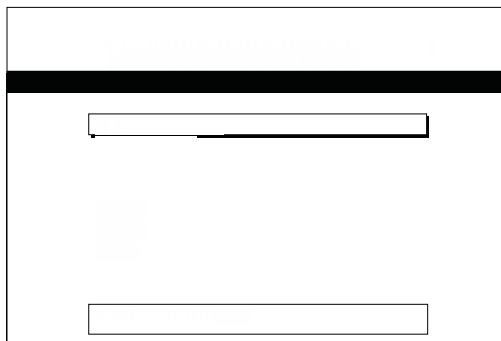

2. Point to Attractions and press SELECT.
3. Point to the type of attraction you want to preview and press SELECT.
4. Press SELECT during the preview to bring up the Program Details display screen.
5. Point and select to buy or find out more about the coming attraction. Purchase the event in the same manner as a PPV program.

Reviewing PPV Purchases

The Past Purchases display screen, which is accessed through the Options menu, allows you to review the programs that

- you have purchased
- have been broadcast
- have not yet been billed to your account.

The list may be longer than one screen; use the down arrow keys to see more items. The Purchase History display screen also shows the title, channel, date, time, and cost of each program.

Note: This list may be modified after each billing cycle.

Canceling PPV Programs

The DSS menu system allows you to cancel any of the pay-per-view events that you have purchased in advance, but haven't watched yet.

To cancel a PPV program.

1. Press MENU to bring up the Main menu.
2. Point to Options and press SELECT.
3. Point to Upcoming Purchases and press SELECT.

The display screen that comes up shows the names, channels, dates, times, and costs of the programs you have ordered.

4. If you want to cancel a program, point to that program and press SELECT.
5. Point to Remove and press SELECT.

The list may be longer than one screen. Use the down arrow key to see more items.

The DSS Mailbox

The DSS mailbox shows you messages that are sent—or “mailed”—from your program providers. For example, you may receive a message calling your attention to a new service.

How to tell when you have mail:

There are two ways to tell if you have mail, depending on whether the DSS receiver is turned on or off.

- *If the DSS receiver is turned on*, a mail icon appears in the channel marker.
- *If the DSS receiver is turned off*, the power light on the front panel of the receiver flashes.

Checking your mail:

1. Press MENU to bring up the Main menu.
2. Point to Mailbox and press SELECT.
The Mailbox display screen shows a list of the messages that have been sent.

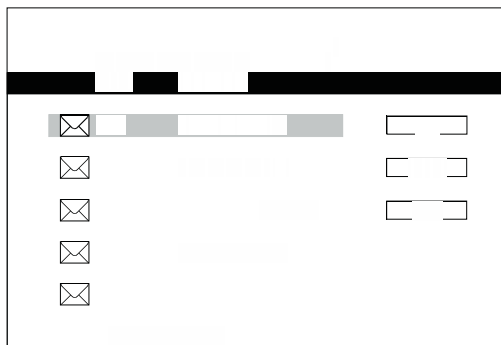

2. Point to a message and press SELECT. The message is opened for you to read. If the letter is longer than one page, you can scroll down using the arrow keys.

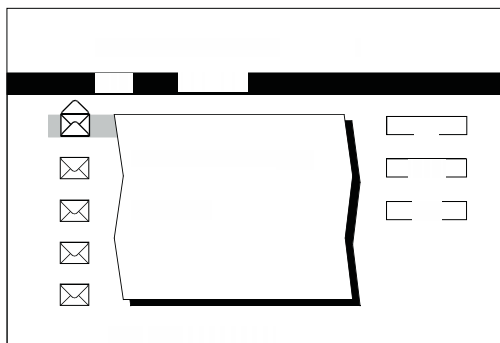

3. Press SELECT again to close the letter.

After you read a message, and want to erase it, point to Erase and press SELECT. When you exit the display screen, messages not erased are saved in memory.

Mailbox Size

The DSS mailbox has enough memory to store ten (10) forty character messages. You should periodically review and erase your mail messages to prevent any mail messages from being erased by the DSS system when memory runs low.

Setting Up Channel Lists

You set up your channel lists by bringing up the Channel Lists and Limits display screen and placing check marks in boxes corresponding to the channels you want in each list.

To bring up the Channel Limits and Lists display screen:

1. Press MENU to bring up the Main Menu.
2. Point to Options and press SELECT.
3. Point to Locks, Limits, and Channel Lists and press SELECT.
4. Point to Channel Limits and Lists and press SELECT. The Channel Limits and Lists display screen comes up.

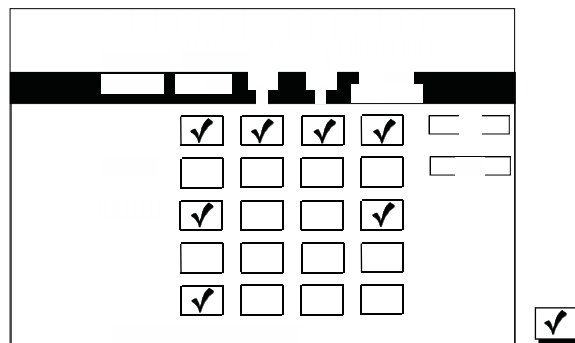

As you can see from the display screen, the available channel lists are **Normal**, **Fav A**, **Fav B**, and **Parent-approved**.

The **Normal** list allows you to delete unwanted channels from the All list and create a new list. **This is the channel list that is in effect each time you turn on the DSS receiver.** A check mark in the Normal column indicates that the channel will be included in your Normal channel list. You can select as many channels as you wish.

The **Fav A** list allows you to build a “Top Ten” favorite channels list. You can select up to 10 channels. A check mark indicates that the channel will be included in your channel list.

The **Fav B** list allows you to build a second “Top Ten” favorite channel list. You can select up to 10 channels. A check mark

indicates that the channel will be included in your channel list.

The **Parent-approved** list, which is actually a channel limit, allows you to select the channels that can be viewed when the system is locked. A channel with a check mark in this column can be viewed at any time, whether the system is locked or unlocked. (For more information about the Parent-approved column, see *Setting Channel Limits*, page 24.)

Building Your Channel Lists

You build your lists by placing check marks in the columns corresponding to each channel in the Channel Limits and Lists display screen.

1. Bring up the Channel Limits and Lists display screen (see above).

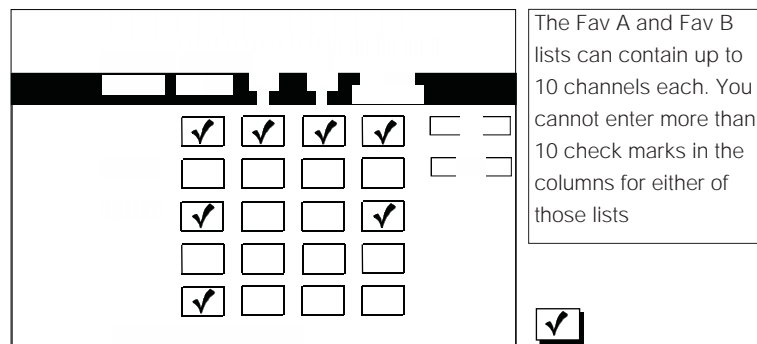

2. Point to the check boxes and press SELECT at each channel you want to include or delete in your lists. A box with a check mark indicates that the channel is included in your list; an unchecked box means that the channel has been taken off the list.
3. To save your channel lists, point to the OK button and press SELECT.

Using Your Channel Lists

Once you have built the channel lists, you can use the lists to:

- Scan through the channels in your selected list using the CHAN ▲/▼ buttons on the remote or front panel
- Simplify your Program Guide by having it show only programs broadcast on the channels in your selected list.

Choosing Your Channel List

There are two ways to choose the channel list that you want to use:

1. Press the FAV (Favorite Channel List) Button
- or
2. Bring up the Select Channel List display screen (accessed through the Options menu).

FAV Button

The FAV button allows you to simplify the Program Guide to show only those channels in your selected list. Press the FAV button to select a channel list. Each time you press FAV, a different list is activated.

The lists cycle in this order: All, Normal, Fav A, Fav B, and so on. A channel marker at the top of the Program Guide indicates which channel list has been selected.

Note: You can choose only from lists that have been set up to include one or more channels.

Once you select a channel list with the FAV button, you can scan through the channels on that list using the ▲/▼ buttons on the remote or front panel.

Select Channel List

The Select Channel List display screen allows you to simplify the Program Guide to show only those channels in your selected list.

(Once you select a channel list with the Select Channel List display screen, you can scan through the channels on that list using the ▲/▼ buttons on the remote or front panel.)

To simplify your Program Guide to show only the channels on your list:

1. Press MENU to bring up the Main menu.
2. Point to Options and press SELECT.
3. Point to Select Channel List and press SELECT.

Select Channel List
Point to a channel list and press SELECT.
Then, point to OK and press SELECT.

Normal List	<input checked="" type="checkbox"/>	<input type="button" value="OK"/>
Favorite List A	<input type="checkbox"/>	<input type="button" value="Help"/>
Favorite List B	<input type="checkbox"/>	
All Channels	<input type="checkbox"/>	

4. Point to the list you wish to use and press SELECT.
5. Point to OK and press SELECT.

This list becomes the list that is in effect until you change the list again or turn the DSS receiver off. **The Normal list is in effect each time you turn on the DSS receiver.**

Your Program Guide will now show programming information for only those channels in your selected list.

Changing Your Channel Lists

You can make changes to your channels lists at any time by repeating Steps 1 through 3 in *Building Your Lists* on page 21.

Setting Ratings, Spending, and Channel Limits

The Locks, Limits, and Channel Lists menu is used to select and enforce the system's rating, spending, and channel limits. If the system is locked, a four-digit password called the "key"—which you define whenever you lock the system—must be entered to override the limits.

To enter the Locks, Limits, and Channel Lists menu:

1. Press MENU to bring up the Main menu.
2. Point to Options and press SELECT.
3. Point to Locks, Limits, and Channel Lists and press SELECT.

The Locks, Limits, and Channel Lists menu comes up.

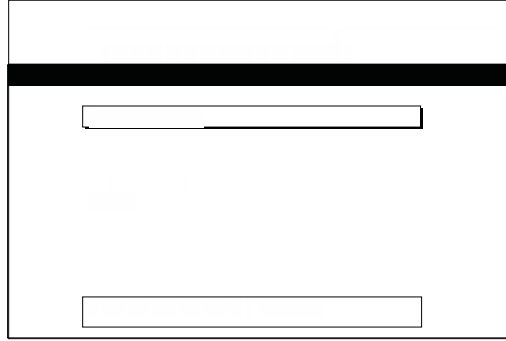

Setting the Ratings Limit

The Ratings Limit display screen allows you to set a maximum viewing limit for rated programs, so long as the program provider has transmitted the proper code. This feature can be used to prevent certain rated programs from being viewed. Once a ratings limit is set and the system is locked, programs that have a higher rating than the set limit cannot be viewed without first entering your four-digit key. You can change your ratings limit whenever you wish.

Note: The rating limit can not be enforced if a program has not been rated, or if rating information for that program is not transmitted by the program provider.

Setting the Spending Limit

The Spending Limit display screen prompts you to set a maximum spending limit for any one program. This may be useful in preventing expensive programs from being purchased inadvertently. Once a limit is set and the system is locked, programs that are more expensive than the limit cannot be purchased and viewed without first entering your four-digit key. You can change your spending limit whenever you wish.

Setting the Channel Limit

The Channel Limit allows you to designate which channels are “parent-approved.” This means that only those channels with check marks in the Parent-approved column of the Channel Limits and Lists display screen can be viewed when the system is locked (see below).

Once a channel limit has been set and the system is locked, programs that are not included in the Parent-approved list cannot be viewed without first entering your four-digit key.

To set channel limits:

1. Press MENU to bring up the Main Menu.
2. Point to Options and press SELECT.
3. Point to Locks, Limits, and Channel Lists and press SELECT.
4. Point to Channel Limits and Lists and press SELECT. The Channel Limits and Lists display screen comes up.

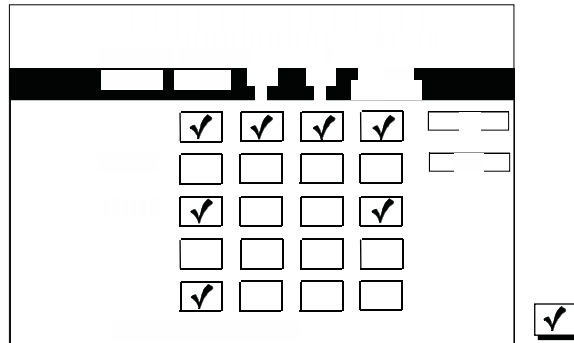

The very first time turn on your receiver, all the channels in the Parent-approved column are checked—no channel limit is in effect until you make changes to the Parent-approved column and lock the system.

5. Point to the channels in the Parent-approved column that you want to include in the Parent-approved channel list.
6. Press SELECT to place or remove a check mark from a channel. A check mark indicates that the channel is Parent-approved, and can be viewed whether the system is locked or unlocked. A check box without a check mark indicates that the channel is not Parent-approved, and that the channel can not be viewed without entering your four-digit key when the system is locked.

Once the system is locked, channels without check marks can not be viewed without first entering your four-digit key.

Locking the System

The Lock System display screen enforces the rating, spending, and channel limits. When you lock the system, you are prompted twice to enter a four digit key: once to choose your number, and a second time to confirm it. **Remember this number!** You will need the number to unlock your system or to override any limits you have set. A closed lock icon is displayed in the channel marker when the system is locked.

If you happen to forget your key, contact your program provider's authorization center.

Unlocking the System

The Unlock System display screen—which is available only when the system is locked—allows you to unlock the system. Unlocking the system turns off any ratings, spending, or channel limits you have set. You must re-lock your system to enforce your limits again (the limits stay the same). An open lock icon appears in the channel marker when the system is unlocked.

Session Unlock

If your system is locked and you attempt to access a channel or program that is blocked by one or more limits, you are asked to enter your four-digit key to override the system lock. **If you enter your key to override the a rating, spending, or channel limit, all limits are unlocked until you turn off the receiver.** When you turn the receiver on again, the system will be locked.

The only way to permanently unlock the system once it has been locked is to enter the Unlock System display screen.

Unlocked v. Locked v. Session Unlock

The paragraphs below describe the differences among the three system lock conditions, Unlocked, Locked, and Session Unlock.

Unlocked

The first time you turn on your receiver, the system is unlocked.

NO ratings, spending or channel limits are enforced.

To lock the system, either set a ratings, spending, or channel limit, or choose Lock System from the Locks, Limits, and Channel Lists.

Locked

To lock the system, either set a ratings, spending, or channel limit, or choose Lock System from the Locks, Limits, and Channel Lists.

You must enter your four-digit key to lock your system.

ALL ratings, spending and channel limits are enforced.

You must provide your four-digit key to override a ratings, spending, or channel limit. Once you have overridden one of these limits, the system enters Session Unlock.

Session Unlock

If you override a limit when the system is locked, the system enters Session Unlock, meaning that *the system is only unlocked from the time you override the limit until the receiver is turned off*.

NO ratings, spending or channel limits are enforced until you turn the receiver off and on again.

To relock system, turn the receiver off and on again. To fully unlock the system, choose Unlock System from the Locks, Limits, and Channel Lists menu.

Alternate Audio Programs

Alternate Audio allows you to select different audio programs to be played with the video (when available). For example, audio broadcast in a second language may be available for certain programs.

There are two ways to change the audio:

1. Press ALT AUD on the remote.
- or
2. Point to Alternate Audio from the Main menu and press SELECT.

ALT AUD Remote Button

Temporary audio selections are made by pressing ALT AUD on the remote. All the available audio types are selected one after another as you continue pressing the ALT AUD button. Once selected, the chosen audio remains selected until it is changed or until the DSS receiver is turned off.

Alternate Audio Display Screen

When you select Alternate Audio from the Main menu, the Alternate Audio display screen comes up.

Point to the audio program type you wish to hear and press SELECT. A

check mark next to the program means you have selected that program. The DSS system will then automatically set the audio program to the selected audio program type, when that type is available.

Other Features

The following paragraphs describe several DSS system features, but don't provide step-by-step instructions. Explore the menu system, if for no other reason than to find out about the different features. Just remember the point and select method, and use the on-line Help where

it is available if you need more information.

Picture Size

The Picture size display screen allows you to choose between a standard TV screen and a Cinema option. A standard TV screen has an aspect ratio of 4:3; the Cinema option has an aspect ratio of 16:9.

Note: You should only use the Cinema option if you have a CinemaScreen® TV: using the Cinema option on a standard TV screen could crop the picture.

System Test

The System Test display screen allows you to initiate diagnostic procedures on the DSS system. You should use this when your receiver doesn't seem to be working correctly. There are four separate tests: signal, tuning, phone and access card.

A message screen appears, telling you whether the system passed each test. If your system fails a test, run the system test several times before concluding that there is a problem. Occasional fluctuations in the phone line or satellite signal can give temporary false readings.

New Access Card Setup

Periodically, your program provider may issue you a replacement access card. The New Access Card Setup display screen allows you to transfer the information from the old card, onto the new one.

Follow the display screen prompts to initialize your new card. Once you have transferred the information to the new card, your old card becomes invalid.

Note: Because your specific account information and custom settings are stored in the access card, power failures should have no effect on your DSS system.

Parts of the DSS System

One way to understand the DSS system is to look at the different parts of the system—from the studio down to the DSS receiver and remote control in your living room.

World View

These parts make up the DSS system “big picture.”

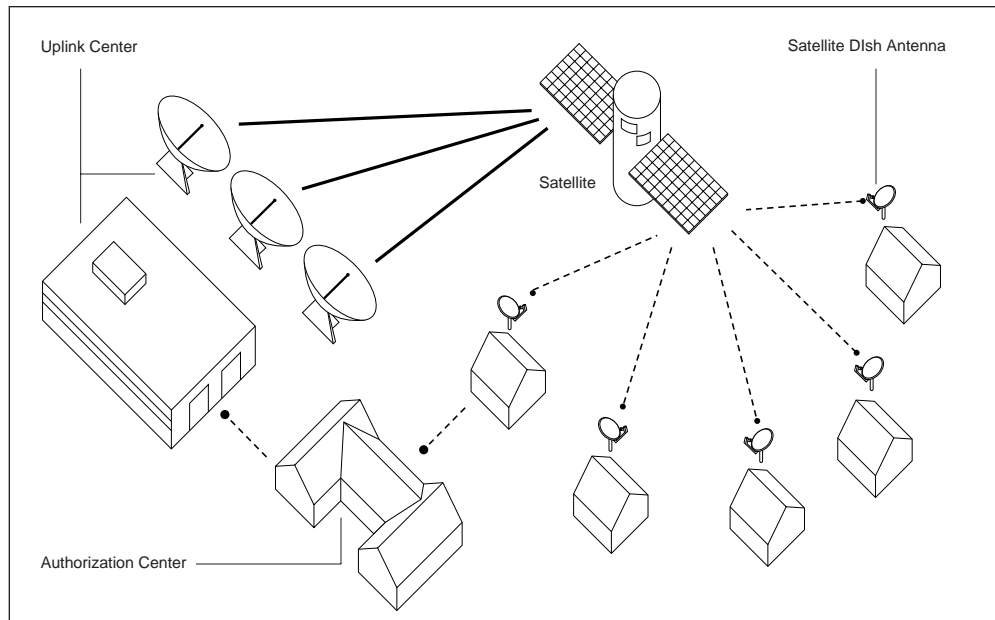

Uplink Center Transmits programming up to the satellite.



Satellite Relays the programming signals back to your satellite dish. The satellite is parked above the equator, in geostationary orbit 22,300 miles above the earth.



DSS Satellite Dish Antenna Receives the satellite signals. Because the satellite is so powerful, the dish can be as small as 18 inches.



Program Provider Authorization Center Processes billing statements. Your DSS system is linked to the Customer Service Center through the phone jack on the back of your DSS receiver.

Home View

These parts are inside of or attached to your house.

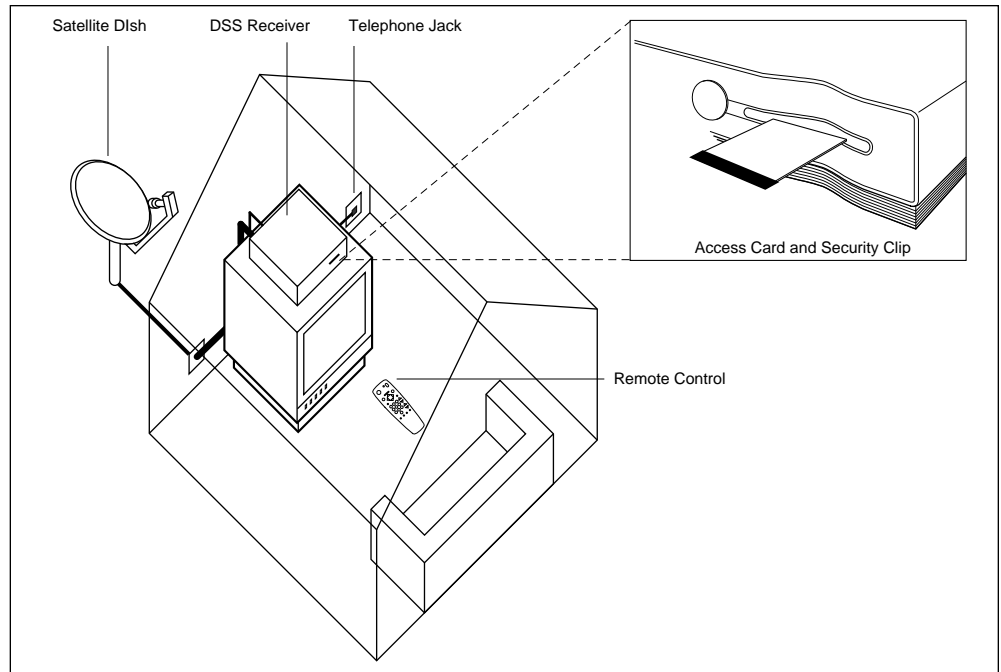

DSS Satellite Dish Picks up the satellite's coded program information and relays it to your DSS receiver. (Your satellite dish may be installed in different locations on or around your house. The satellite dish must, however, be pointed in a southern direction toward the satellite.)



DSS Receiver Receives the TV program information and sends it to your TV or VCR.



Telephone Jack Connects to the phone jack on the back of the DSS receiver. The DSS receiver uses a toll-free number once a month to update your access card. This update only takes a few seconds and ensures that you will have continuous service. The system automatically hangs up if you pick up the phone when the DSS receiver is calling out.

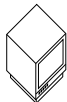

Television If your television is remote controllable, you can program the DSS Universal TV Remote to change channels and volume.



DSS TV Universal Remote (included with your DSS system) Controls the DSS system as well as most remote controllable TVs. Point the remote at the device you want to control.



Access Card (installed in DSS receiver) Must be inserted for you to use the DSS system! Provides system security and authorization of DSS services. Do not remove the card except when issued a new card as a replacement for the original.



Security Clip (installed in DSS receiver) Fits over the end of the access card and helps prevent the card from being inadvertently removed. To remove the clip, squeeze the top and bottom together and slide the clip off the access card.

Back Panel

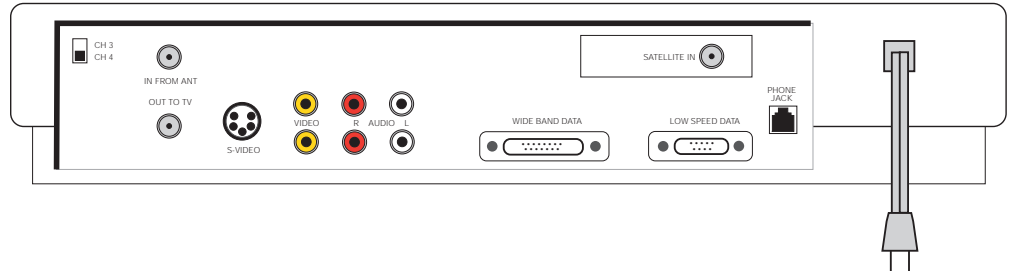

3/4 SWITCH If you use the OUT TO TV jack to connect your DSS receiver to the TV, set the switch to 3 view the programming on TV channel 3. Set the switch to 4 to show the programming on channel 4.



IN FROM ANT Used to connect a normal television antenna or cable service to your DSS receiver.



OUT TO TV Used to connect the DSS receiver to your TV using coaxial cable.
Note: Connecting your DSS receiver to the TV using the S-Video or Audio and Video jacks (if available on your TV) will give you better picture and sound than the OUT TO TV jack.



S-VIDEO Used to connect your DSS receiver to your TV, if the TV has S-Video capability. The S-Video connection provides the best possible picture quality, and can also be connected to a VCR to record programming (if the VCR also has an S-video jack). If you use the S-Video jack, you must also use the AUDIO R and AUDIO L jacks, described below.



VIDEO Used to connect your DSS receiver to your TV, if the TV has AUDIO/VIDEO input jacks. If you use the VIDEO jack you must also use the associated AUDIO R and AUDIO L jacks.



AUDIO R (right) and AUDIO L (left) Used to connect your DSS receiver to your TV, if the TV has AUDIO/VIDEO input jacks. If you use the AUDIO R and AUDIO L jacks you must also use the associated VIDEO jack. You can also connect the audio outputs to the audio inputs on a stereo amplifier. Either jack will provide mono sound if connected to a mono TV.



WIDE BAND DATA PORT Will allow you to use the DSS system with new technologies, such as high-definition TV (HDTV), as they become available. A shielded cable and additional hardware may be required.



LOW SPEED DATA PORT Will allow you to use the DSS system with new technologies as they become available. A shielded cable and additional hardware may be required.



SATELLITE IN Used to connect the coaxial cable from your DSS satellite dish to your DSS receiver.



PHONE JACK Used to connect the phone line to the DSS receiver. The DSS receiver should be connected to a phone line for best performance.

Front Panel*

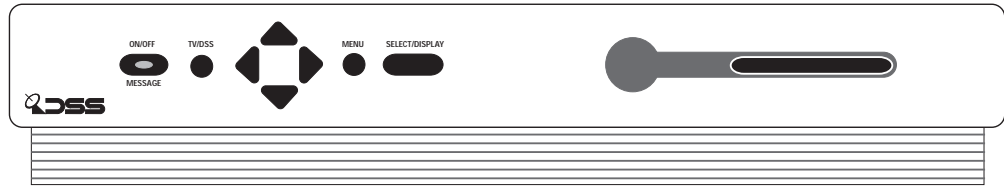

ON/OFF/MESSAGE Turns the DSS receiver on and off. When the DSS receiver is turned off, a flashing light indicates that a message has been sent by the Customer Service Center. Note: the DSS receiver is never really “off,” but is put into a standby state.



TV/DSS Switches the OUT TO TV connection from DSS programming to the normal TV antenna or cable input. Similar to the TV/VCR button on many VCRs.



ARROW KEYS Allows you to move around the Program Guide and menu system. Use these to point before selecting an item. When you are not in the Program Guide or the menu system, the up/down arrows can be used to change channels.



MENU Brings up the Main menu.



SELECT/DISPLAY Chooses an item you have pointed to when using the Program Guide or menus. Also brings up a channel marker showing the time, channel, and other program details when you are viewing a program or previewing a coming attraction.



ACCESS CARD SLOT Insert your access card with the arrow face up and pointing toward the box. The DSS receiver is shipped with the access card inserted into the slot. Do not remove the access card, except to install a new card issued to you as a replacement for the original card.

* The front panel can be used to control the DSS receiver when the remote is unavailable.

Caution:

Do not stack electronic components or other objects on top of the receiver. The slots on top of the receiver must be left uncovered to allow proper airflow to the unit. Blocking airflow to the receiver could impair performance or cause damage to your receiver or other components.

Do not stack the receiver on top of a “hot” component, such as an audio power amplifier.

Remote Buttons

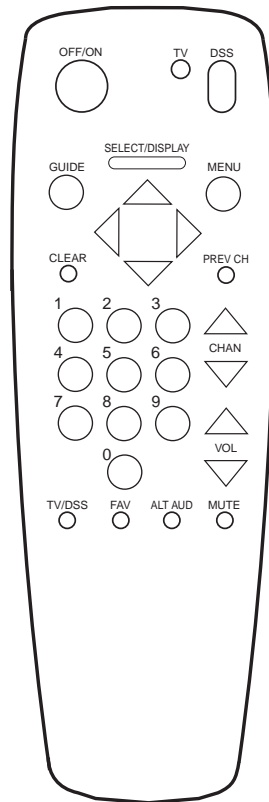

ARROWS Used to point to different items in the Program Guide or menu system.



SELECT/DISPLAY Selects items in the Program Guide and the menu system. When viewing a program, SELECT/DISPLAY brings up a channel marker providing detailed program information. When previewing a coming attraction or pay-per-view event, SELECT provides purchase information.



OFF/ON Turns the device you are now controlling with the remote on and off. (Actually, the DSS receiver is never really off," but is put into a standby state.)













TV Turns on the TV if your remote has been programmed to control an RCA, PROSCAN, or GE TV. (The DSS remote is preprogrammed to control most RCA, PROSCAN and GE TVs.) Also puts the remote in TV mode. If your remote has been programmed to control another brand of TV, press TV and OFF/ON to turn on the TV. See Section 2: *Setting Up the Remote*, page 36.



DSS Turns on the DSS receiver and puts the remote in DSS mode (the remote now controls the DSS receiver).



GUIDE Brings up the Program Guide. Pressing the GUIDE button more than once brings up the the different guide views, or channel groupings, as they are made available by your program providers. Continue to press the GUIDE button to return to the normal guide view.

-  **MENU** Brings up the Main menu. If you are already in a menu, pressing MENU has the same effect as pressing SELECT. If you are in the Program Guide, press MENU to bring up the Select Guide display screen which allows you to choose one of the available special guides offered by your program providers.
-  **CHAN UP / DOWN (channel up/down)** Scans up and down through the channels programmed in the current channel list (like using your regular TV remote). Also allows you to page through the Program Guide and change channels on the TV when the remote is in TV mode.
-  **VOL UP / DOWN (volume up/down)** Controls the TV volume output (if the remote is programmed to control the TV).
-  **0-9 (number buttons)** Allow you to select menu items quickly and enter numerical values in some display screens. Also allows you to show a channel's listings quickly in the Program Guide; directly tune to a channel number; and tune to a channel on the TV when the remote is in the TV mode.
-  **CLEAR** Removes all on-screen displays from the TV screen. Any uncompleted display screen is canceled and the previous setting restored.
-  **ALT AUD (alternate audio)** Used to select different audio options for a particular program, if available. Continue to press ALT AUD to cycle through the available audio channels.
-  **FAV (favorite channel list)** Selects a channel scan list. Continue to press the FAV button to cycle through the four DSS channel scan lists: Normal, Favorite A, Favorite B, and All channels. Note: the only lists that are available are those that have been set up to include one or more channels.
-  **TV/DSS** Switches the OUT TO TV output from the satellite signal to the home antenna or cable signal (if one is connected to the IN FROM ANTENNA jack on the back of the DSS receiver).
-  **PREV CH (previous channel)** Swaps the current channel with the last channel tuned.
-  **MUTE** Turns the TV's sound off if the remote is programmed to control your TV. Press MUTE again to restore the sound.

Setting up the Remote

The DSS remote can be programmed to control most brands of remote controllable TVs. Most RCA, GE and ProScan TVs are already programmed. Other manufacturer's brands need to be programmed.

Installing the Batteries

Follow these steps whenever you need to install or change the batteries in your DSS remote.

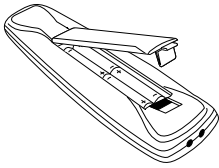

1. Pull off the cover of the battery compartment.
2. Place four AAA batteries as shown, matching the + and - end of each battery in each compartment.
3. Replace the cover.

Programming the Remote to Control Your TV

To determine whether your remote needs to be programmed, turn the TV on, point the remote at the TV, and press the TV button. Then press CHAN UP or DOWN to see whether the TV responds to the remote commands.

Follow these steps to program your remote to control your TV.

1. Turn on the TV.
2. Look up your brand and code number(s) on TV Code list on the next page.
3. Press *and hold* the TV button.
4. Enter the three-digit code from the code list.
5. *Release the TV button* and press POWER or CHAN UP/DOWN to see if the TV responds to the remote commands. If it doesn't, try the next code listed for your brand.
6. Repeat these steps until the TV responds to the remote commands.

For easy reference, record your code here.

Note: For PROSCAN, RCA, and GE TVs, pressing the device button will usually turn the device on; use the POWER button to turn the device off.

TV Codes

Akai.....	002	KTV.....	078	Sampo.....	011,027
Anam National.....	038	Loewe.....	013	Samsung.....	006,011,014, 015,019,027,036,037,077
AOC.....	011,019,027,088	Luxman.....	011,027	Sanyo.....	017,021,039, 056,057,058
Candle.....	011,027,033	LXI.....	013,018,021,023,054	Scott.....	028,037,064
Citizen.....	011,027,033,064	Magnavox.....	006,007, 010,011,013,016,027,033, 035,043,049,066,087,089	Sears.....	000,006,011,014, 017,018,021,023,027, 039,040,041,051,071,083
Colortyme.....	011,027,084	Marantz.....	013	Sharp.....	011,020,025,027, 037,052,053,059,060
Concerto.....	011,027	Marantz.....	011,013,027,069	Sony.....	002
Contec/Cony.....	036,037,040,042,064	MGA.....	006,011,014,019, 022,027,041,056,061,068	Soundesign.....	011,027,033
Craig.....	064	Mitsubishi.....	006,011,014,019, 022,027,041,055,056,061,068	Sylvania.....	006,007,010, 011,013,016,027,033, 035,043,049,066,087,089
Curtis Mathes.....	000,011,015,027,037	MTC.....	011,019,027	Symphonic.....	064,076
CXC.....	064	Multivision.....	081	Tatung.....	038
Daewoo.....	011,019,027	NAD.....	018,023	Technics.....	012
Daytron.....	011,027	NEC.....	011,014,019,027,038,084	Techwood.....	011,027
Electrohome.....	006,011,014, 027,038,061,068	Panasonic.....	012,013,038,086	Teknika.....	011,019,027, 033,036,037,040,066
Emerson.....	011,026,027,028, 029,030,031,032,037,042,053,064,065, 067,075,076,078,079	Penney.....	000,008,011,019, 027,040,068,077,086,088	Telecaption.....	090
Envision.....	011,027	Philco.....	006,007,010,011,013, 016,019,027,033,035, 037,038,043,087,089	TMK.....	011,027
Fisher.....	017,021,039,041	Philips.....	002,006,007,010, 011,013,016,033, 035,037,038,043,066,073	Toshiba.....	018,021,023, 040,071,077,085
Funai.....	064	Pioneer.....	011,027,045,062,093	Universal.....	008,009
GE.....	000,008,009,011,012, 027,038,068,086,089,091	Portland.....	011,019,027,037	Victor.....	051
Goldstar.....	003,004,006, 011,019,027,037,050	ProScan.....	000	Vidtech.....	019,027
Hallmark.....	011,027	Proton.....	011,027,037,072	Wards.....	000,005,006, 007,008,009,010,011, 013,019,025,027,028, 035,043,059,066,076,082,089
Hitachi.....	009,011,027,036, 037,040,047,063,080	Quasar.....	012,038,092	Yamaha.....	006,014,019,027
Infinity.....	013	Radio Shack.....	000,021,025, 036,037,059,064,078	Zenith.....	001
JBL.....	013	RCA.....	000,006,011,019, 027,034,038,044,046,088,100		
Jensen.....	011,027	Realistic.....	021		
JVC.....	012,024,036, 037,040,048,051,074				
Kawasho.....	002,011,027				
Kenwood.....	006,011,014,027				
Kloss Novabeam.....	035,043				

Connecting Your DSS Receiver to Your TV

If your DSS system has not been professionally installed, or if you move your system or add a component, refer to these pages to help you connect your system.

Jacks and Cables

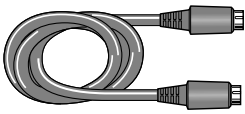

See Connection A.

S-Video Jack and Cable* (S-VHS)

The S-Video jack provides the best picture quality for your DSS system.

This jack is available on many TVs and is used in conjunction with audio cables to connect the DSS receiver to your TV. Remember also to connect the left and right audio cables because the S-Video jack carries only the picture signal, not the sound.

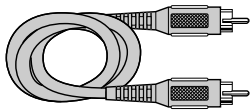

See Connection B

Audio/Video Jacks and Cables* (RCA-type)

The audio/video jacks provide very good picture and stereo sound quality, and should be used if your TV has no S-Video jack.

These jacks are used for most audio/video connections between components. The DSS receiver audio/video jacks are color coded (yellow for video, red for right audio, and white for left audio). If your TV has only one input for audio (mono), connect it to the right (red) audio jack on the DSS receiver.

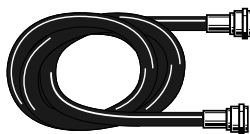

See Connection C
and Connection D.

RF Jacks and Coaxial Cables* (F-type)

The RF jacks provide good picture and mono sound quality, and are to be used if audio/video connections are not available for your TV.

These jacks are required for antenna or cable-TV connections. The RF jacks on the DSS receiver are labeled IN FROM ANTENNA and OUT TO TV. The coaxial cable supplied with your DSS system is used to connect the RF jacks between the DSS receiver and your TV's antenna input.

* Included

Choosing a Connection

The following pages show four examples of hookups commonly used to connect the DSS receiver with a TV and other components. Refer to your TV and VCR Owner's Manuals for more information on hooking up your specific components.

The four hookup diagrams are:

Connection A

Provides the best possible picture and stereo audio quality.

To use Connection A, you must have:

- TV with S-Video input, plus separate RF and audio/video inputs (jacks).
- VCR with RF and audio/video inputs and outputs
- S-Video, coaxial, and audio/video cables

Connection B

Provides very good picture and stereo audio quality.

To use Connection B, you must have:

- TV with separate RF and audio/video inputs (jacks)
- VCR with RF and audio/video inputs and outputs
- Coaxial and audio/video cables

Connection C

Provides good picture and mono audio quality.

To use Connection C, you must have:

- TV with RF input (jack)
- VCR with RF and audio/video inputs
- Coaxial and audio/video cables

Connection D

Provides good picture and mono audio quality.

To use Connection D, you must have:

- TV with RF input (jack)
- Coaxial cables

Connection A (Best Picture and Sound Quality)

To use this connection you must have:

- TV with separate RF, audio/video, and S-Video inputs (jacks)
- VCR with RF and audio/video inputs
- Coaxial, audio/video, and S-Video cables

To connect TV, VCR and antenna or cable box.

1. Connect coaxial cables as shown.
2. Connect audio/video cables as shown.
3. Connect S-Video cable as shown.

To receive DSS programming:

1. Tune TV to receive the S-Video output from the DSS receiver.
2. Tune DSS receiver to desired channel.

To receive off-air programming (no cable box):

1. Turn VCR off or press TV/VCR button.
2. Tune TV to desired channel.

To receive off-air programming (with cable box):

1. Turn VCR off or press the VCR's TV/VCR button.
2. Tune TV to cable box output channel (usually CH2, CH3, or CH4).
3. Tune cable box to desired channel.

To record DSS programming:

1. Tune TV to receive S-Video output from DSS receiver.
2. Tune DSS receiver to desired channel.
3. Set your VCR to record on line input. (See your VCR Owner's Manual for more information.)

To view VCR programming:

1. Tune TV to VCR output channel (usually CH3 or CH4).

CAUTION

Do not stack electronic components or other objects on top of the DSS receiver. See *Safety Information*, inside front cover.

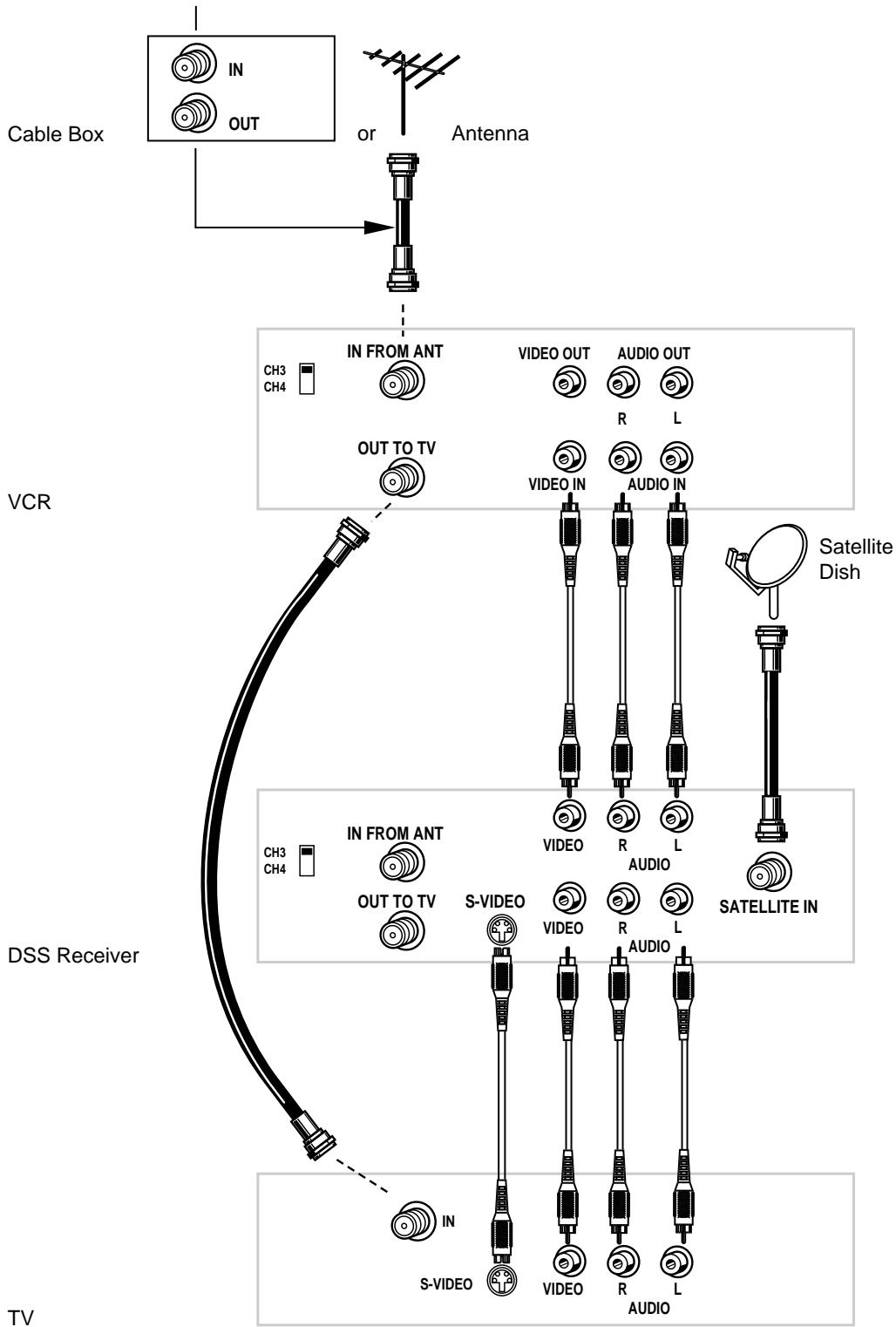

Connection A

Connection B (Very Good Picture and Sound Quality)

To use this connection you must have:

- TV with separate RF and audio/video inputs (jacks)
- VCR with RF and audio/video inputs
- Coaxial and audio/video cables

To connect TV, VCR and antenna or cable box.

1. Connect coaxial cables as shown.
2. Connect audio/video cables as shown.

To receive DSS programming:

1. Tune TV to receive line output from DSS receiver (often called Input 1).
2. Tune DSS receiver to desired channel.

To receive off-air programming (no cable box):

1. Turn VCR off or press VCR's TV/VCR button.
2. Tune TV to desired channel.

To receive off-air programming (with cable box):

1. Turn VCR off or press VCR's TV/VCR button.
2. Tune TV to cable box output channel (usually CH2, CH3, or CH4).
3. Tune cable box to desired channel.

To record DSS programming:

1. Tune TV to record line output from DSS receiver (often called Input1).
2. Tune DSS receiver to desired channel.
3. Set your VCR to record on line input.

To view VCR programming:

1. Tune TV to VCR output channel (usually CH3 or CH4).

CAUTION

Do not stack electronic components or other objects on top of the DSS receiver. See *Safety Information*, inside front cover.

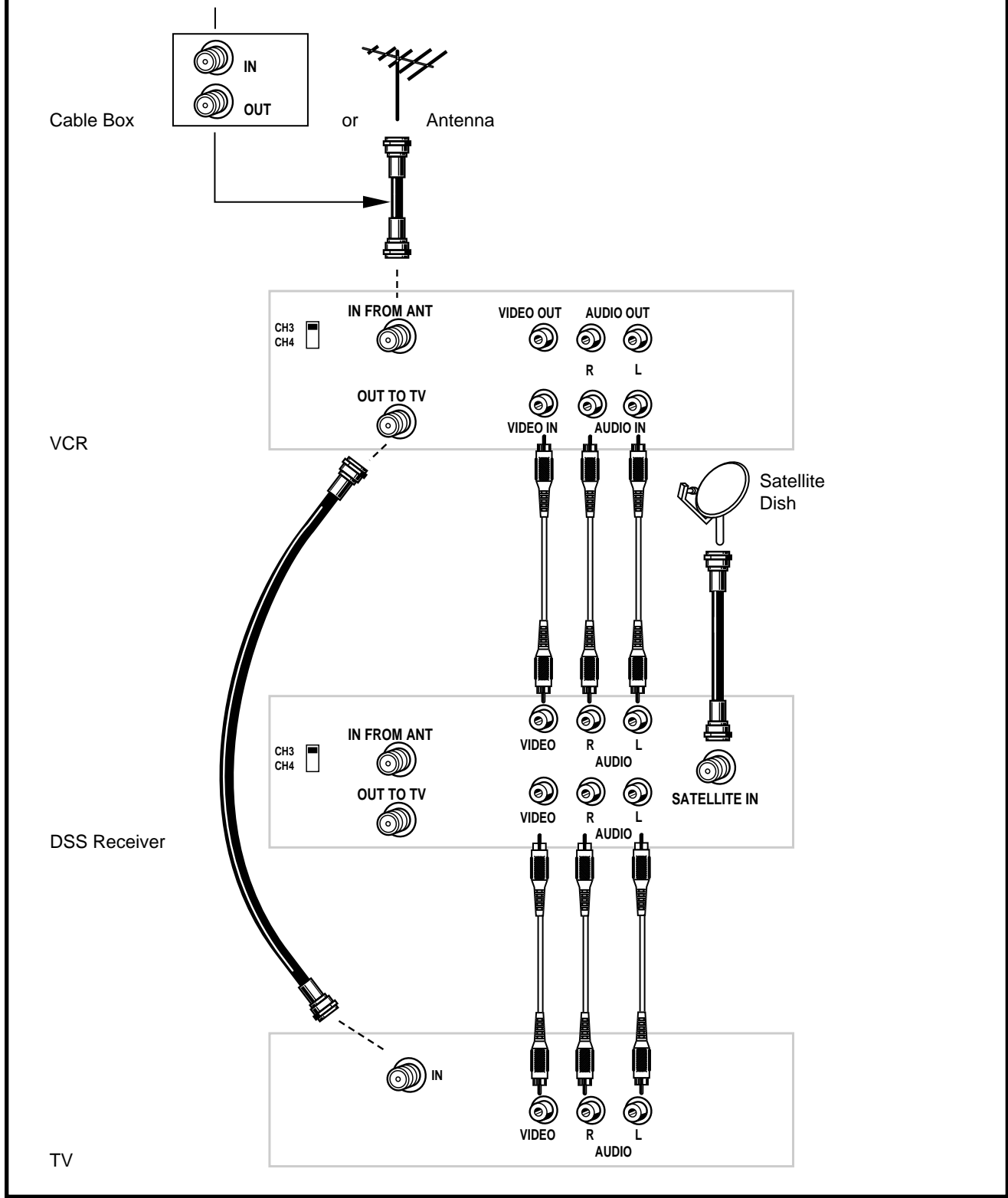

Connection B

Connection C (Good Picture and Sound Quality)

To use this connection you must have:

- TV with RF input (jack)
- VCR with RF and audio/video inputs
- Coaxial and audio/video cables

To connect TV, VCR, and antenna or cable box.

1. Connect coaxial cables as shown.
2. Connect audio/video cables as shown.

To receive DSS programming:

1. Set DSS receiver 3/4 switch to CH3 or CH4 (whichever is not being broadcast in your area.)
2. Tune TV to whichever channel you set the DSS receiver 3/4 switch to in the previous step.

To receive off-air programming (no cable box):

1. Turn DSS receiver off (or press TV/DSS button).
2. Turn VCR receiver off (or press VCR's TV/VCR button).
3. Tune TV to desired channel.

To receive cable programming (with cable box):

1. Turn DSS receiver off (or press TV/DSS button).
2. Turn VCR receiver off (or press VCR's TV/VCR button).
3. Tune TV to cable box output channel (usually CH2, CH3, or CH4).
4. Tune cable box to desired channel.

To record DSS programming:

1. Set DSS receiver 3/4 switch to CH3 or CH4 (whichever is not being broadcast in your area.)
2. Tune TV to whichever channel you set the DSS receiver 3/4 switch to in the previous step.
3. Tune DSS receiver to desired channel.
4. Set VCR to record on line input.

To view VCR programming:

1. Tune TV to VCR output channel (usually CH3 or CH4).
2. Turn DSS receiver off (or press TV/DSS button).

Note: You can use your stereo amplifier line input to hear stereo using this connection. See your stereo amplifier's Owner's Manual for specific information.

CAUTION Do not stack electronic components or other objects on top of the DSS receiver. See *Safety Information*, inside front cover.

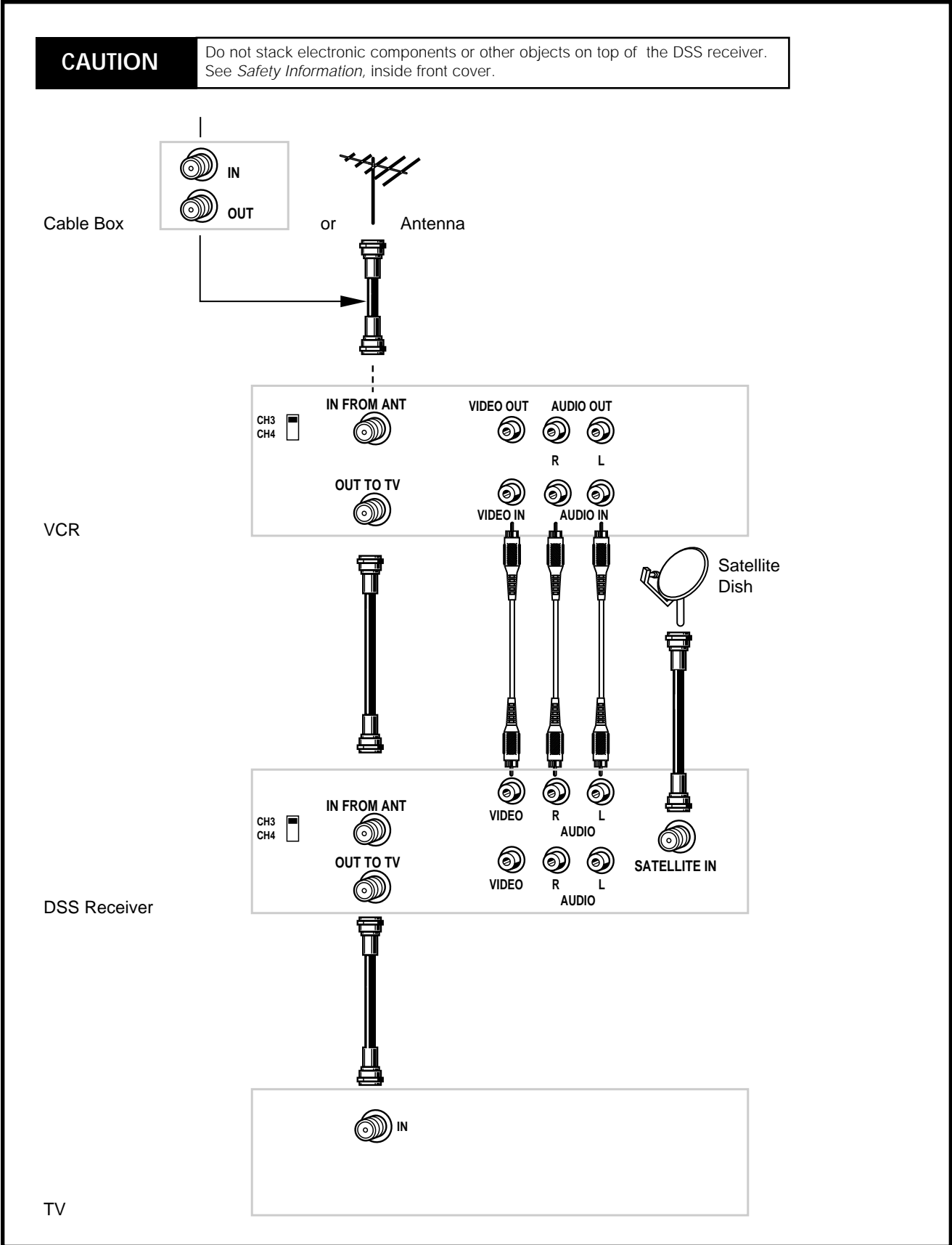

Connection C

Connection D (Good Picture and Sound Quality)

To use this connection you must have:

- TV with RF input
- Coaxial cables

To connect TV and antenna or cable box:

1. Connect coaxial cables as shown.

To receive DSS programming:

1. Set DSS receiver 3/4 switch to CH3 or CH4 (whichever is not being broadcast in your area.)
2. Tune TV to whichever channel you set the DSS receiver 3/4 switch to in the previous step.
3. Tune DSS to desired channel.

To receive off-air programming (no cable box):

1. Turn DSS receiver off (or press TV/DSS button).
2. Tune TV to desired channel.

To receive cable programming (with cable box):

1. Turn DSS receiver off (or press TV/DSS button).
2. Tune TV to cable box output channel (usually CH2, CH3, or CH4).
3. Tune cable box to desired channel.

Note: You can use your stereo amplifier line input to hear stereo using this connection. See your stereo amplifier's Owner's Manual for specific information.

CAUTION

Do not stack electronic components or other objects on top of the DSS receiver. See *Safety Information*, inside front cover.

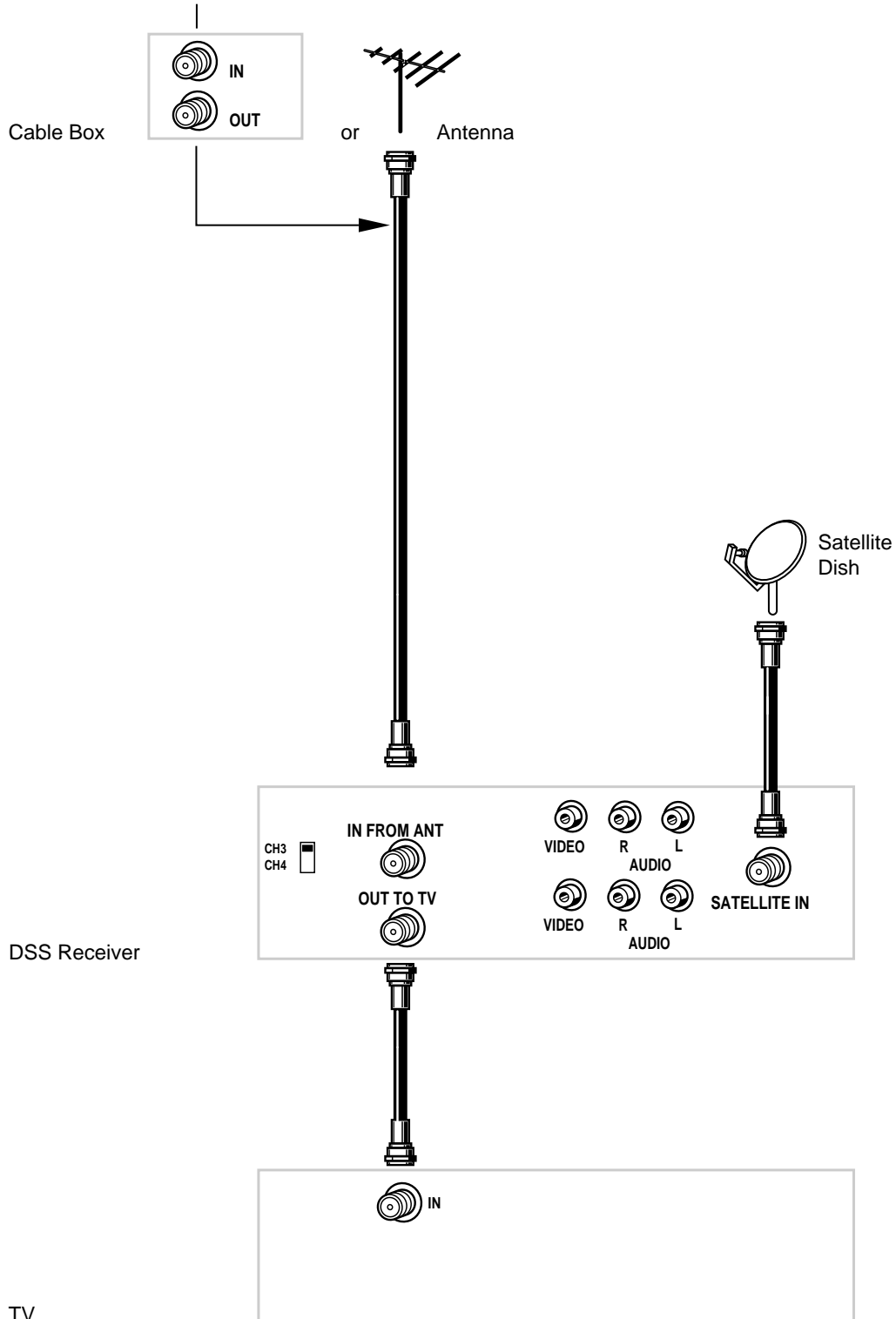

Connection D

Glossary

Access Card	Identifies you to the DSS service providers and is required for your DSS system to work. Do not remove the access card except when a new card has been issued to replace the original.
Alternate Audio	Refers to the different audio channels that may be broadcast in conjunction with a video program. A foreign language translation is an example.
Attractions	Previews of special programs broadcast by your program provider.
Azimuth	Refers to the left-to-right positioning of your DSS dish. When you enter your zip code (or latitude and longitude), the display screen provides the number corresponding to an azimuth setting for your location.
Channel Limit	Allows you to select which channels can be viewed when the system is locked.
DSS Receiver	Receives, processes, and converts the digitally compressed satellite signals into audio and video.
Elevation	Refers to the up and down positioning of your DSS dish. When you enter your zip code (or latitude and longitude), the display screen provides the number corresponding to the elevation setting for your location.
Key	The 4-digit password—that you define—that allows you to limit access certain features of your DSS system.
Limits	There are three kinds of limits. The Ratings Limit allows you to control program viewing of rated programs by ratings level. The Spending Limit controls spending on a cost-per-program basis. The Channel Limit allows you to select which channels can be viewed when the system is locked.
Locks	The means of restricting access to certain features of the DSS system. The lock is controlled by a 4-digit key that acts as a password. The closed or open lock icon in the channel marker indicates whether your system is locked or unlocked.
Mailbox	Stores incoming electronic messages sent to you by your program providers. The Mailbox is accessed through the on-screen menu system, and can store up to ten messages of forty characters each.
Main Menu	The first list of choices in the DSS on-screen menu system. Press the MENU button on the remote or front panel to bring up the Main menu.
Past Purchases	Detailed list of the programs that you have already purchased and viewed.

Parent-Approved	Channels that are checked in the Parent-approved column of the Channel Lists and Limits display screen are the only channels that can be viewed when your system is locked.
Point and Select	The method of using the remote control (or front panel) buttons to navigate to and make choices among the different parts of the on-screen displays.
Program Guide	Lists and updates the programs and services available from your program providers.
Ratings Limit	Provides a means of restricting viewing of rated programs, based on program rating information. The operation of this feature depends upon the availability and accuracy of data supplied from and broadcast by the program provider.
Signal Meter	An on-screen display that indicates the relative strength of the satellite signal and sounds a test tone to help you lock in on the satellite signal. The signal meter is used when you adjust your DSS dish.
Spending Limit	Provides a means of restricting viewing; based on cost-per-program limit.
System Test	Provides a diagnostics check that can be used to determine that the main components of the DSS system—signal, tuning, phone, and access card—are connected and working properly.
Themes	Provides a way to simplify the Program Guide and make it easier to find programs of special interest to you.
TV/DSS	Remote control and front panel button that toggles the input signal to your TV from the antenna or cable signals to the satellite signal. Similar in function to that of TV/VCR buttons on some VCRs and remote controls.
Upcoming Purchases	Detailed list of the programs you have purchased but have not yet been broadcast.

Menu Tree

The following diagram shows the structure of the on-screen menu system. You can access all display screens through these menus.

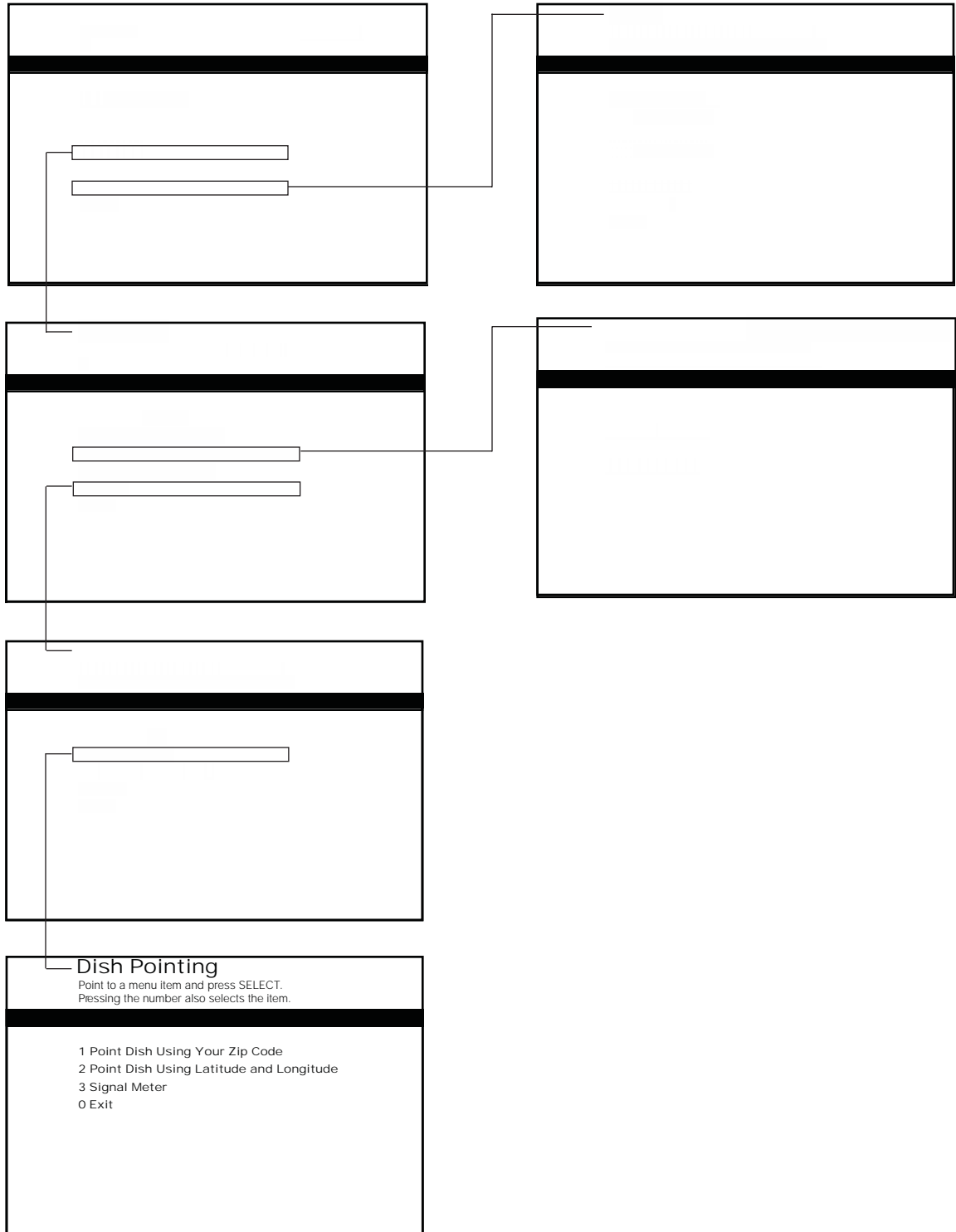

Troubleshooting

The DSS System Test allows you to run a basic diagnostics check on your DSS system. If you are experiencing any trouble with your system, run the system test.

Make sure that

- All connections—jacks, cables, etc. are correctly in place. See *Connecting Your DSS Receiver*, page 38, for more information.
- There are batteries in the remote, and that they are working correctly.
- The access card is installed in the receiver.

Running the System Test

Follow these steps to run the diagnostics system test on your system.

1. Turn on your TV and the DSS receiver.
2. Press DSS to put remote in DSS mode, then press MENU to bring up the Main menu.
3. Point to Options and press SELECT. The Options menu comes up.
4. Point to Setup and press SELECT. The Setup menu comes up.
5. Point to System Test and press SELECT. The System Test display screen comes up.

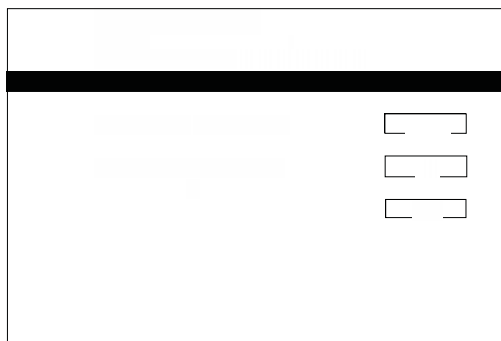

6. Point to the Test button and press SELECT. Follow the on-screen directions after the test is completed.
7. If your system does not pass the system test, check any of these potential trouble areas: cabling, pointing the satellite dish, phone connection, and access card.
8. If you continue to have problems, call 1-800-679-4776.

Warranty Information

Toll-free telephone product help

You can reach Thomson at the following number: 1-800-679-4776 (Toll free inside U.S.A.) Our toll-free number operates from 9:00 a.m. to 6:00 p.m. EST on weekdays.

Thomson provides a toll-free telephone number to help you with any problems you may encounter with your DSS System, as many problems can be diagnosed over the phone. If necessary, a replacement unit can be shipped to you. **Please have your DSS System model/serial number and date of purchase ready when you call.** If your unit is out of warranty, we will quote the cost of an exchange unit to you.

Returning Equipment to Thomson for Repair or Exchange

If we are unable to resolve your problem over the phone we will gladly service your unit or exchange it for a new or refurbished unit. Refer to the limited warranty included in this booklet to learn about your specific rights and responsibilities. *Always consult Thomson and get a Return Authorization number before returning anything.* Obtain a Return Authorization (RA) number from the Thomson telephone representative before returning your equipment to avoid delays, accounting errors, or even loss of your unit.

Important Information to Customers Who Ship Defective Equipment to Thomson Consumer Electronics

The Thomson representative who authorizes the return of your equipment will give you an RA number over the phone. They will also provide you with instructions on where and how to return your unit. Write the number in large, clear characters on the outside of the box. *To avoid confusion and misunderstandings, shipments without an RA number clearly visible on the outside of the box will be returned to you at your expense.*

Include a brief note describing the problem and any conversations about the problem you have had with Thomson personnel. Include your name, address and model/serial number of your unit. These numbers are located on the back of your receiver. **If your DSS System is within the warranty period, please provide a copy of the bill of sale to verify purchase date.** Use the original box and packing material to protect the equipment from damage in shipment. For your protection, insure all shipments for full replacement value and use a reliable shipper. Thomson assumes no responsibility for warranty shipments from the customer to the factory if not shipped in the manner prescribed by Thomson.

Limited Warranty

What your warranty covers:

- Any defect in materials, workmanship, or basic installation, provided installation is performed by a Thomson Consumer Electronics Authorized Installer.

For how long after your purchase:

- 90 days for labor charges.
- One year for parts.

What we will do:

During the initial 90 days:

- Exchange the defective portion of your DSS System with a new or, at our option, refurbished unit and correct any basic installation defects at no cost to you.

After the 90 days and within one year:

- Exchange the defective portion of your DSS System with a new, or at our option, refurbished unit. We will bill you a flat exchange charge to replace a defective receiver. This charge covers the labor cost for its repair. Labor costs for the removal and re-installation of any equipment are your responsibility.

How you get service:

- Call 1-800-679-4776 and have your unit's date of purchase and model/serial number ready. The model/serial number information is on the back of your receiver.
- A representative will troubleshoot your problem over the phone.
- If the representative determines that you should receive a replacement receiver, you will be provided with a Return Authorization (RA) number and the location of a nearby exchange point if one exists. No returns will be accepted without an RA number.
- If the representative determines that your antenna/dish is defective they will arrange for its repair or replacement.
- If the representative determines that installation is defective they will arrange for its repair.

To receive a replacement receiver before you return yours:

- **If you are located near an exchange point:**
 1. We will send a replacement unit to our exchange point next business day delivery.
 2. The exchange location will notify you of its arrival.
 3. Take your unit, including all accessories, and your bill of sale which validates date of purchase to the exchange location and you will be provided the new or refurbished unit.
 4. If the repairs are covered by your warranty, you will not be billed.

- **If you are not located near an exchange point:**

1. Provide your Discover, Mastercard or Visa account number and expiration date to your phone representative. This is for security purposes only and your account will not be charged at this time.
2. We will send you a replacement unit next business day delivery.
3. If you return the unit to us within 14 days from the date you were provided a Return Authorization number, only items not covered by warranty will be charged to your account. If your unit is not received within 14 days, the suggested retail value of the receiver will be charged to your credit card. This amount will be credited if the unit is subsequently received.
4. Ship your defective unit back to us along with all accessories included with your receiver using the replacement unit's carton. Shipping instructions will be included on the carton along with your RA number which will allow you to easily ship the unit back to us. Make sure you insure your shipment in case of damage or loss. Include with the shipment:
 - A copy of your dated bill of sale to verify your unit's warranty eligibility.
 - A brief note describing your receiver problem.
 - Your name, address and phone number.

Thomson assumes no responsibility of warranty shipments from the customer to the factory if not shipped in the manner prescribed by Thomson.

To receive a replacement receiver after we have received your unit:

- Write the RA number on the outside of the carton used to return the unit. Make sure you insure your shipment in case of damage or loss.
- Carefully pack the unit along with all accessories included with your receiver, using the original box and packing material if possible.
- Include with the shipment:
 - A copy of your dated bill of sale to verify your unit's warranty eligibility.
 - A brief note describing your receiver problem.
 - Your name, address and phone number.

Thomson assumes no responsibility of warranty shipments from the customer to the factory if not shipped in the manner prescribed by Thomson.

- Include a cashier's check or money order for payment if there are any out of warranty labor or parts charges which were indicated by the representative, and you elected not to use your credit card.
- After we receive your product, a new or refurbished unit will be shipped to you next business day delivery.

What your warranty does not cover:

- Adjustment of customer controls.
- Damage from misuse or neglect.
- A unit that has been modified or incorporated into other products or is used for institutional or other commercial purposes.
- Batteries for remote control hand units.
- Units purchased, serviced or operated outside the U.S.A.
- Loss of programming.
- Shipping damage if the unit was not packed and shipped in the manner prescribed by Thomson.
- Storage fees may be charged by the exchange point if you fail to pickup the replacement unit in a timely manner.
- Any installation other than a basic initial installation. A basic initial installation consists of:
 - Antenna mounted to a single family dwelling using 100' or less of cable.
 - Antenna grounded to meet National Electric Code (NEC).
 - Routing of the cabling through a normal frame structure or only one layer of masonry.
 - One TV connected per each receiver.
 - A telephone cable and connection installed at the connected TV.
- Any installations performed by other than Thomson Consumer Electronics Authorized Installers.

Product Registration:

- Please complete and mail the Product Registration Card packed with your DSS product. It will make it easier to contact you should it ever be necessary. The return of the card is not required for warranty coverage.

How State Law relates to warranty:

- This warranty gives you specific legal rights and you also may have other rights that vary from state to state.

If you purchased your DSS Product in Canada:

- See your dealer for details.

FCC Regulations

FCC REGISTRATION INFORMATION

Your DSS equipment is registered with the Federal Communications Commission and is in compliance with parts 15B and 68, FCC Rules and Regulations.

1. Notification to the Local Telephone Company

On the bottom of this equipment is a label indicating among other information, the FCC Registration number and Ringer Equivalence Number (REN) for the equipment. You must, upon request, provide this information to your telephone company.

The REN is useful to determine the number of devices you may connect to your telephone line and still have all these devices ring when your telephone number is called. In most (but not all) areas, the sum of the REN's of all devices connected to one line should not exceed 5. To be certain of the number of devices you may connect to your line as determined by the REN, you should contact your local telephone company.

Notes: This equipment may not be used on coin service provided by the telephone company.

Party lines are subject to state tariffs, and therefore, you may not be able to use your own telephone equipment if you are on a party line. Check with your local telephone company.

Notice must be given to the telephone company upon permanent disconnection of your DSS equipment from your line.

2. Rights of the Telephone Company.

Should your equipment cause trouble on your line which may harm the telephone network, the telephone company shall, where practicable, notify you that temporary discontinuance of service may be required. Where prior notice is not practicable and the circumstances warrant such action, the telephone company may temporarily discontinue service immediately. In case of such temporary discontinuance, the telephone company must: (1) promptly notify you of such temporary discontinuance (2) afford you the opportunity to correct the situation and (3) inform you of your right to bring a complaint to the Commission pursuant to procedures set forth in Subpart E of Part 68, FCC Rules and Regulations.

The telephone company may make changes in its communications facilities, equipment, operations or procedures where such action is required in the operation of its business and not inconsistent with FCC Rules and Regulations. If these changes are expected to affect the use or performance of your telephone equipment, the telephone company must give you adequate notice, in writing, to allow you to maintain uninterrupted service.

RADIO INTERFERENCE

This equipment has been type tested and found to comply with the limits for a Class B Digital Device in accordance with the specifications in Part 15 of FCC Rules. These rules are designed to provide reasonable protection against radio and television interference in a residential installation. This equipment generates, uses and can radiate radio frequency energy and, if not installed and used in accordance with the instructions, may cause harmful interference to radio communications. However, there is no guarantee that interference will not occur in a particular installation.

If this equipment does cause interference to radio or television reception (which you can determine by turning the equipment off and on), try to correct the interference by one or more of the following measures.

- Reorient or relocate the receiving antenna (that is, the antenna for radio or television that is “receiving” the interference).
- Change the position of the DSS satellite receiver with respect to the radio or television equipment that is receiving interference.
- Move the DSS satellite receiver away from the equipment that is receiving interference.
- Plug the DSS satellite receiver into a different wall outlet so that the DSS satellite receiver and the equipment receiving interference are on different branch circuits.

If these measures do not eliminate the interference, please consult your dealer or an experienced radio/television technician for additional suggestions. Also, the Federal Communications Commission has prepared a helpful booklet, “How To Identify and Resolve Radio/TV Interference Problems”. This booklet is available from the U.S. Government Printing Office, Washington, D.C. 20402. Please specify stock number 004-000-00345-4 when ordering copies.

Canadian D. O. C. Regulations

NOTICE:

The Canadian Department of Communications label identifies certified equipment. This certification means that the equipment meets certain telecommunications network protective, operational and safety requirements. The Department does not guarantee the equipment will operate to the user's satisfaction.

Before installing this equipment, users should ensure that it is permissible to be connected to the facilities of the local telecommunications company. The equipment must also be installed using an acceptable method of connection. The customer should be aware that compliance with the above conditions may not prevent degradation of service in some situations.

Repairs to certified equipment should be made by an authorized Canadian maintenance facility designated by the supplier. Any repairs or alterations made by the user to this equipment, or equipment malfunctions, may give the telecommunications company cause to request the user to disconnect the equipment.

Users should ensure for their own protection that the electrical ground connections of the power utility, telephone lines and internal metallic water pipe system, if present, are connected together. This precaution may be particularly important in rural areas.

CAUTION:

Users should not attempt to make such connections themselves, but should contact the appropriate electric inspection authority, or electrician, as appropriate.

NOTICE:

The Load Number (LN) assigned to each terminal device denotes the percentage of the total load to be connected to a telephone loop which is used by the device, to prevent overloading. The termination on a loop may consist of any combination of devices subject only to the requirement that the sum of the Load Numbers of all the devices does not exceed 100.

This apparatus does not exceed the Class B Limits for radio noise emissions as set out in the interference-causing equipment standard ICES-003 of the Department of Communications.

Accessories

Cables and Connectors

RG-6 Coaxial Burial Cable with weather-proof "F" connectors:



D912 (12 feet)
D925 (25 feet)
D950 (50 feet)
D901 (100 feet)

Stereo Audio Video Cable with gold RCA-type connectors.

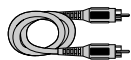

D906 (6 feet)
D914 (12 feet)

S-VHS Video Cable



D913 (12 feet)

(2) Weatherproof "F" Connectors for RG-6 coaxial cable



D905

Miscellaneous Supplies

Grounding Block for RG-6 coaxial cable

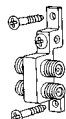

D902

TVRO Bullet Amplifier



D903

Self-Installer's Kit

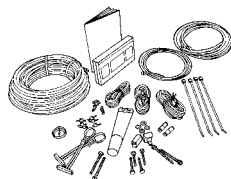

DKIT94

Cut Here

Order Form for DSS Accessories

Description	Stock No.	Price Each*	Qty	Total Amount
Coaxial Cable				
12 feet	D912	\$12.95		
25 feet	D925	\$15.95		
50 feet	D950	\$21.95		
75 feet	D975	\$29.95		
100 feet	D901	\$35.95		
Audio/Stereo Cable				
12 feet	D914	\$14.95		
6 feet	D906	\$12.95		
S-VHS Video Cable	D913	\$12.95		
"F" Connector	D905	\$ 5.30		
Grounding Block	D902	\$ 2.95		
TVRO Bullet Amplifier	D903	\$24.95		
Self-Installer's Kit	DKIT94	\$69.95		

*Prices are subject to change without notice	
Total Merchandise (\$10 minimum order)	\$ _____
Sales Tax	\$ _____
We are required by law to collect the appropriate sales tax for each individual state, county, and locality to which the merchandise is being sent.	
Shipping, Handling, and Insurance	\$ <u>5.00</u>
Total Amount Enclosed	\$ _____
VISA or MasterCard Preferred.	

Complete other side, also. →

Specifications and descriptions of accessories are subject to change without notice.

USE YOUR CREDIT CARD

Copy complete account number 

Card expires:

Copy complete account number 

Copy Number above the name on your MasterCard

Card expires:

AUTHORIZED SIGNATURE

Prices are subject to change without notice.

PLEASE



Print or type your name and address. This will be your mailing label.

A complete and correct order will save you days of waiting.

Name: _____

Street: _____

_____ Apt: _____

City: _____

State: _____ Zip: _____

Make sure that both sides of this form have been filled out.

United States Orders

To place your order by phone, have your Visa or MasterCard ready and call the toll-free number listed below between 8AM and 8PM Eastern Standard Time. **Use this number only to place an order for accessory items listed on this order form.**

1 – 800 – 338 – 0376

Most times your order will be shipped UPS within 72 hours of receipt. If ever it is not possible to ship within 30 days, we will notify you with an update on your order and an option to cancel.

To place your order by mail, detach and mail the completed order form with credit card information, money order, or check in U.S. currency (made payable to Thomson Consumer Electronics) to the following address:

Video Accessories
P.O. Box 8419
Ronks, PA 17573

For more information on these accessories (or current prices), write to the following address:

Video Accessories Customer Service
Thomson Consumer Electronics
Distributor & Special Products
2000 Clements Bridge Rd
Deptford, NJ 08096-2088

Canadian Orders

For Canada inquiries, please call one of these toll-free numbers for information about accessories:

English: 1 – 800 – 522 – 0338
French: 1 – 800 – 552 – 0445

International Orders

This offer is valid only in the 50 United States. For international orders, please send your request for quotation (not an order) to:

International Customer Service
Thomson Consumer Electronics
Distributor & Special Products
2000 Clements Bridge Rd
Deptford, NJ 08096-2088 USA

Cut Here

Cut Here

Index

0-9 keys.....	35	Back Panel	15	Receiver	31
3/4 Switch.....	32	Glossary	15	Remote.....	34-47
Access Card.....	29, 31	Hooking up DSS receiver.....	38-47	installing batteries	36
new card setup	31	Hookup diagrams	41,43,45,47	programming	36
security clip	31	Installation	4	TV codes	37
Access card slot	33	IN FROM ANT.....	32	Remote Buttons	34-35
Accessories	59-60	Jacks and Cables.....	42	RF jacks and cables.....	38
All sorting button.....	9	Key.....	23	S-Video jacks and cables.....	38
ALT AUD	27, 35	Locks and Limits	22-24	S-VIDEO	32
Alternate Audio.....	27	ratings limit	24	Satellite.....	26
Alternate Audio programs.....	27	spending limit	24	SATELLITE IN	32
Arrows.....	5,33,34	setting limits.....	24	Satellite dish	31
Arrow Keys	5,33,34	locking the system.....	25	Satellite dish antenna.....	30
Audio/Video Jacks.....	32	unlocking the system.....	26	Scrolling.....	7
Auto Help	14	Locking the system.....	25	Security clip	31
Batteries, remote.....	36	Low Speed Data Port.....	32	SELECT.....	5,33,34
Back Panel	15,32	Mailbox.....	18-20	Select Channel List.....	22
Build Channel Lists.....	21	Checking mail	18,19	SELECT/DISPLAY	5,29,30
Channel Lists.....	20-22	Mailbox size	20	Setting Up the Remote.....	36-41
Normal	20	Main menu.....	6	installing batteries	36
FAV A	20,21	MENU.....	6,33,35	programming	36
FAV B	20,21	Menu Help.....	15	TV codes	40
FAV button.....	22	Menus.....	10	Simplify Program Guide.....	8
Select Channel List.....	22	display screens.....	11	Sorting buttons	9
Channel Up/Down	7, 35, 36, 37	Help.....	14	All	9
CLEAR button.....	7,10,35	Movies sorting button.....	9	Movies.....	9
Connecting the DSS system.....	38-47	Mute	35	Other	9
Connections, choosing.....	39	Note about the manual.....	4	Sports	9
Display screens.....	11	Number keys	35	Themes.....	9
Down arrow button.....	8	OFF/ON	34	Sports sorting button.....	9
DSS button.....	34	Options menu.....	11	System Test.....	29
DSS Limited Warranty.....	52	Other sorting button.....	9	Themes sorting button	9
DSS receiver.....	31	OUT TO TV	32	TV	34
DSS Universal remote control	31	Paging.....	7	TV codes	40
Exit button	8	Phone Jack.....	32	TV/DSS	35
FAV	35	Picture Size	29	Unlocking the system.....	26
FCC Regulations	52	Pay-per-view programs	16,17,18	Uplink Center	30
Features	16	Point and Select.....	5	Using On-line Help	14-15
Alternate Audio	27	PREV CHAN	35	Using the menu system.....	10-12
Building Channel Lists.....	21	Previous channel.....	35	Using this manual.....	4
Locks and Limits	23-27	Program Details	14	Using the Program Guide	6-9
Mailbox	18	Program Guide	6-9,17	VIDEO jack.....	32
New Access Card Setup.....	31	bringing up	6	Volume	35
Pay-per-view programs	16	exiting	7	VOL UP/DOWN button.....	35
Picture Size.....	29	getting around in	7	Warranty Information.....	52
System Test	29	scrolling.....	7	Wide band data port.....	32
Front Panel, Help Menu	15	paging	7		
Front Panel	33	changing channels.....	7		
Glossary, Help Menu.....	15	sorting	8-9		
GUIDE button.....	6,35	Program Provider	30		
Help buttons.....	14	Programming remote	36		
Help Menu.....	15	Push buttons.....	13		
Program Guide.....	15	Ok	13		
Menu System.....	15	Exit	13		
Front Panel.....	15	Help.....	13		

