

# Instructions for use

## WASHING MACHINE

**GB**

English, 1

**WMUD 823**

### Contents

#### **Installation, 2-3-4-5**

Unpacking and levelling  
Connecting the electricity and water supplies  
The first wash cycle  
Technical data

#### **Care and maintenance, 6**

Cutting off the water or electricity supply  
Cleaning the washing machine  
Cleaning the detergent dispenser drawer  
Caring for the door and drum of your appliance  
Cleaning the pump  
Checking the water inlet hose

#### **Precautions and tips, 7**

General safety  
Disposal  
Opening the porthole door manually

#### **Description of the washing machine, 8-9**

Control panel  
Display

#### **Running a wash cycle, 10**

#### **Wash cycles and functions, 11**

Table of wash cycles  
Wash functions

#### **Detergents and laundry, 12**

Detergent dispenser drawer  
Preparing the laundry  
Special wash cycles  
Load balancing system

#### **Troubleshooting, 13-14**

#### **Assistance, 15-16**

# Installation

GB

! Keep this instruction manual in a safe place for future reference. Should the appliance be sold, transferred or moved, make sure the instruction manual accompanies the washing machine to inform the new owner as to its operation and features.

! Read these instructions carefully: they contain vital information on installation, use and safety.

## Unpacking and levelling

### Unpacking

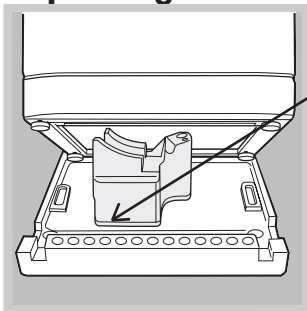

! This is a separate part of the polystyrene base and should be removed with the base.

! **IMPORTANT check when unpacking your machine.**

1. Unpack the washing machine.
2. Check whether the washing machine has been damaged during transport. If this is the case, do not install it and contact your retailer.

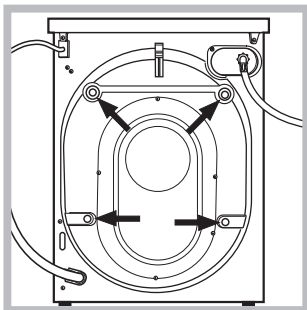

3. Remove the 4 protective screws and the rubber bush with the respective spacer, situated on the rear of the appliance (see also the installation leaflet).
4. Seal the gaps using the plastic plugs provided.

5. Keep all the parts: you will need them again if the washing machine needs to be moved to another location.

! Packaging materials are not children's toys.

### Levelling

Your machine may make a considerable amount of noise if the two front feet have not been adjusted correctly.

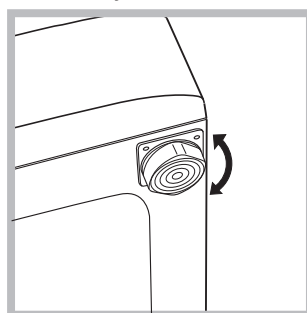

1. Install the washing machine on a flat sturdy floor, without resting it up against walls, cabinets or anything else.

2. If the floor is not perfectly level, compensate for any unevenness by tightening or loose-

ning the adjustable front feet (see figure); the angle of inclination, measured according to the worktop, must not exceed 2°.

Levelling your appliance correctly will provide it with stability and avoid any vibrations, noise and shifting during operation. If it is placed on a fitted or loose carpet, adjust the feet in such a way as to allow enough room for ventilation beneath the washing machine.

## Electric and water connections

### Connecting the water inlet hose

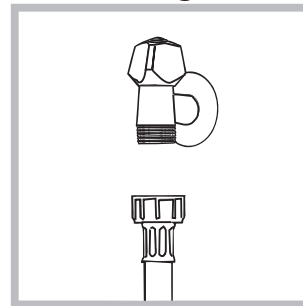

1. Connect the supply pipe by screwing it to a cold water tap using a 3/4 gas threaded connection (see figure).

Before performing the connection, allow the water to run freely until it is perfectly clear.

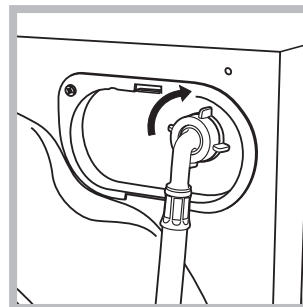

2. Connect the other end of the water inlet hose to the washing machine, screwing it onto the appliance's cold water inlet, situated on the top right-hand side on the rear of the appliance (see figure).

3. Make sure there are no kinks or bends in the hose.

! The water pressure at the tap must be within the values indicated in the Technical details table (on the page 5).

! If the water inlet hose is not long enough, contact a specialist store or an authorised serviceman.

! Ensure that the supply taps are allowing water through. Old taps may seize in the closed position and thus prevent water reaching the machine.

! Never use second-hand or old inlet hoses; use the products supplied with the machine.

## Connecting the drain hose

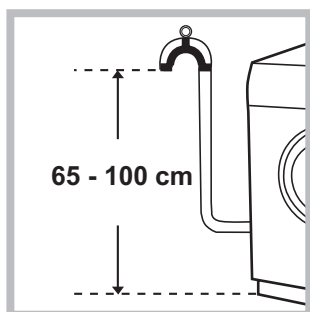

Connect the drain hose, without bending it, to a draining duct or a wall drain situated between 65 and 100 cm from the floor;

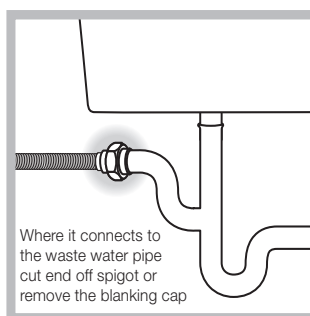

The drain hose may be connected to an under-sink trap. Before connecting the drain hose from the machine ensure that any blanks or removable ends have been taken off the spigot.

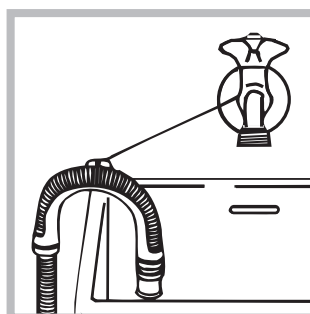

If it is placed over the edge of a basin or sink be sure the free end of the hose should not be under-water.

**!** We advise against the use of hose extensions; in case of absolute need, the extension must have the same diameter as the original hose and must not exceed 150 cm in length. Ensure that if the drain hose is pushed into a standpipe, that the end does not go down more than 15cms (6 inches). If the hose is pushed down too far, this may cause the machine to self-siphon ie. continuously empty as it is filling.

## Electric connection

Before plugging the appliance into the mains socket, make sure that:

- the socket is earthed and in compliance with the applicable law;
- the socket is able to sustain the appliance's maximum power load indicated on the Technical Data Plate fixed on the machine;

- the supply voltage is included within the values indicated on the Technical Data Plate fixed on the machine.

- the socket is compatible with the washing machine's plug. If this is not the case, replace the socket or the plug.

Your appliance is now supplied with a 13 amp fused plug it can be plugged into a 13 amp socket for immediate use. Before using the appliance please read the instructions below.

**WARNING - THIS APPLIANCE MUST BE EARTHED.**  
THE FOLLOWING OPERATIONS SHOULD BE CARRIED OUT BY A QUALIFIED ELECTRICIAN.

### Replacing the fuse:

When replacing a faulty fuse, a 13 amp ASTA approved fuse to BS 1362 should always be used, and the fuse cover re-fitted. If the fuse cover is lost, the plug must not be used until a replacement is obtained.

### Replacement fuse covers:

If a replacement fuse cover is fitted, it must be of the correct colour as indicated by the coloured marking or the colour that is embossed in words on the base of the plug. Replacements can be obtained directly from your nearest Service Depot.

### Removing the plug:

If your appliance has a non-rewireable moulded plug and you should wish to re-route the mains cable through partitions, units etc., please ensure that either:  
the plug is replaced by a fused 13 ampere rewireable plug bearing the BSI mark of approval.

or:

the mains cable is wired directly into a 13 amp cable outlet, controlled by a switch, (in compliance with BS 5733) which is accessible without moving the appliance.

### Disposing of the plug:





Ensure that before disposing of the plug itself, you make the pins unusable so that it cannot be accidentally inserted into a socket.

Instructions for connecting cable to an alternative plug:

Important: the wires in the mains lead are coloured in accordance with the following code:

<b>Green &amp; Yellow</b>	<b>Earth</b>
<b>Blue</b>	<b>Neutral</b>
<b>Brown</b>	<b>Live</b>



Technical data	
<b>Model</b>	WMUD 823
<b>Dimensions</b>	width 59.5 cm height 85 cm depth 60.5 cm
<b>Capacity</b>	from 1 to 8 kg
<b>Electrical connections</b>	please refer to the technical data plate fixed to the machine
<b>Water connections</b>	maximum pressure 1 MPa (10 bar) minimum pressure 0.05 MPa (0.5 bar) drum capacity 62 litres
<b>Spin speed</b>	up to 1200 rotations per minute
<b>Test wash cycles in accordance with directives 1061/2010 and 1015/2010</b>	programme  (60°) (1st press of the button); Standard Cotton 60°. programme  (40°) (2nd press of the button); Standard Cotton 40°.
 	This appliance conforms to the following EC Directives: - 2004/108/EC (Electromagnetic Compatibility) - 2006/95/EC (Low Voltage) - 2002/96/EC

# Care and maintenance

GB

## Cutting off the water and electricity supplies

- Turn off the water tap after every wash cycle. This will limit wear on the hydraulic system inside the washing machine and help to prevent leaks.
- Unplug the washing machine when cleaning it and during all maintenance work.

## Cleaning the washing machine

- The outer parts and rubber components of the appliance can be cleaned using a soft cloth soaked in lukewarm soapy water. Do not use solvents or abrasives.
- The washing machine has a “Auto Clean” programme for its internal parts that **must be run with no load in the drum**.

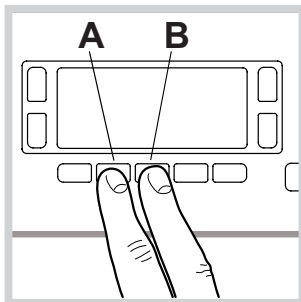

To help the wash cycle you may want to use either the detergent (i.e. a quantity 10% the quantity specified for lightly-soiled garments) or special additives to clean the washing machine. We recommend running a cleaning

programme every 40 wash cycles. To start the programme press buttons **A** and **B** simultaneously for 5 seconds (see figure). The programme will start automatically and will run for about 70 minutes. To stop the cycle press the START/PAUSE button.

## Cleaning the detergent dispenser drawer

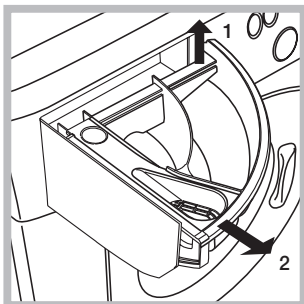

Remove the dispenser by raising it and pulling it out (see figure). Wash it under running water; this operation should be repeated frequently.

## Caring for the door and drum of your appliance

- Always leave the porthole door ajar in order to prevent unpleasant odours from forming.

## Cleaning the pump

The washing machine is fitted with a self-cleaning pump which does not require any maintenance. Sometimes, small items (such as coins or buttons) may fall into the pre-chamber which protects the pump, situated in its bottom part.

- ! Make sure the wash cycle has finished and unplug the appliance.

To access the pre-chamber:

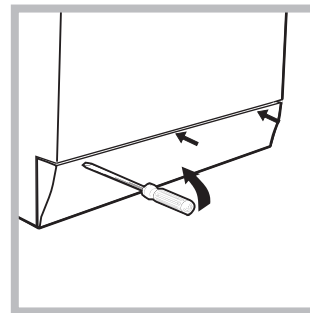

1. using a screwdriver, remove the cover panel on the lower front part of the washing machine (see figure);

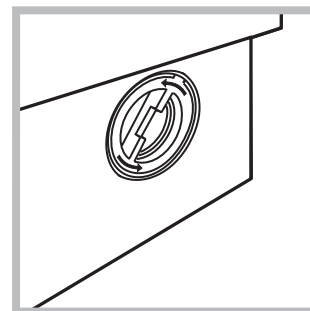

2. unscrew the lid by rotating it anti-clockwise (see figure): a little water may trickle out. This is perfectly normal;

3. clean the inside thoroughly;
4. screw the lid back on;
5. reposition the panel, making sure the hooks are securely in place before you push it onto the appliance.

## Checking the water inlet hose

Check the inlet hose at least once a year. If there are any cracks, it should be replaced immediately: during the wash cycles, water pressure is very strong and a cracked hose could easily split open.

- ! Never use second-hand hoses.

! This washing machine was designed and constructed in accordance with international safety regulations. The following information is provided for safety reasons and must therefore be read carefully.

## General safety

- This appliance was designed for domestic use only.
- This appliance is not intended for use by persons (including children) with reduced physical, sensory or mental capabilities, or lack of experience and knowledge, unless they have been given supervision or instruction concerning use of the appliance by a person responsible for their safety. Children should be supervised to ensure that they do not play with the appliance.
- Do not touch the machine when barefoot or with wet or damp hands or feet.
- Do not pull on the power supply cable when unplugging the appliance from the electricity socket. Hold the plug and pull.
- Do not open the detergent dispenser drawer while the machine is in operation.
- Do not touch the drained water as it may reach extremely high temperatures.
- Never force the porthole door. This could damage the safety lock mechanism designed to prevent accidental opening.
- If the appliance breaks down, do not under any circumstances access the internal mechanisms in an attempt to repair it yourself.
- Always keep children well away from the appliance while it is operating.
- The door can become quite hot during the wash cycle.
- If the appliance has to be moved, work in a group of two or three people and handle it with the utmost care. Never try to do this alone, because the appliance is very heavy.
- Before loading laundry into the washing machine, make sure the drum is empty.

## Disposal

- Disposing of the packaging materials: observe local regulations so that the packaging may be re-used.
- The European Directive 2002/96/EC on Waste Electrical and Electronic Equipment, requires that old household electrical appliances must not be disposed of in the normal unsorted municipal waste stream. Old appliances must be collected separately in order to optimise the recovery and recycling of the materials they contain and reduce the impact on human health and the environment. The crossed out “wheeled bin” symbol on the product reminds you of your obligation, that when you dispose of the appliance it must be separately collected. Consumers should contact their local authority or retailer for information concerning the correct disposal of their old appliance.

## Opening the porthole door manually

In the event that it is not possible to open the porthole door due to a powercut, and if you wish to remove the laundry, proceed as follows:

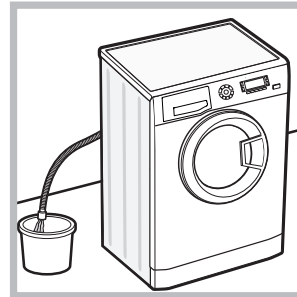

1. remove the plug from the electrical socket.
2. make sure the water level inside the machine is lower than the door opening; if it is not, remove excess water using the drain hose, collecting it in a bucket as indicated in the figure.

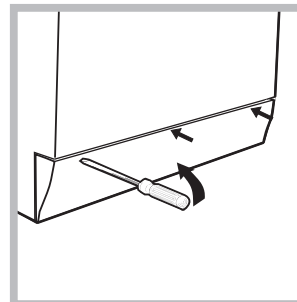

3. using a screwdriver, remove the cover panel on the lower front part of the washing machine (see figure).

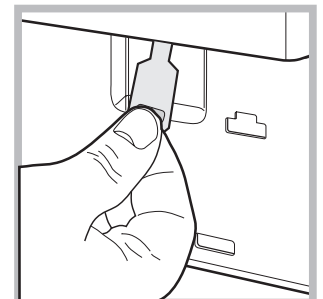
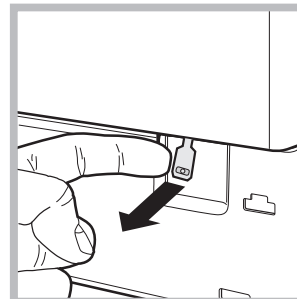

4. pull outwards using the tab as indicated in the figure, until the plastic tie-rod is freed from its stop position; pull downwards and open the door at the same time.

5. reposition the panel, making sure the hooks are securely in place before you push it onto the appliance.

# Description of the washing machine

GB

## Control panel

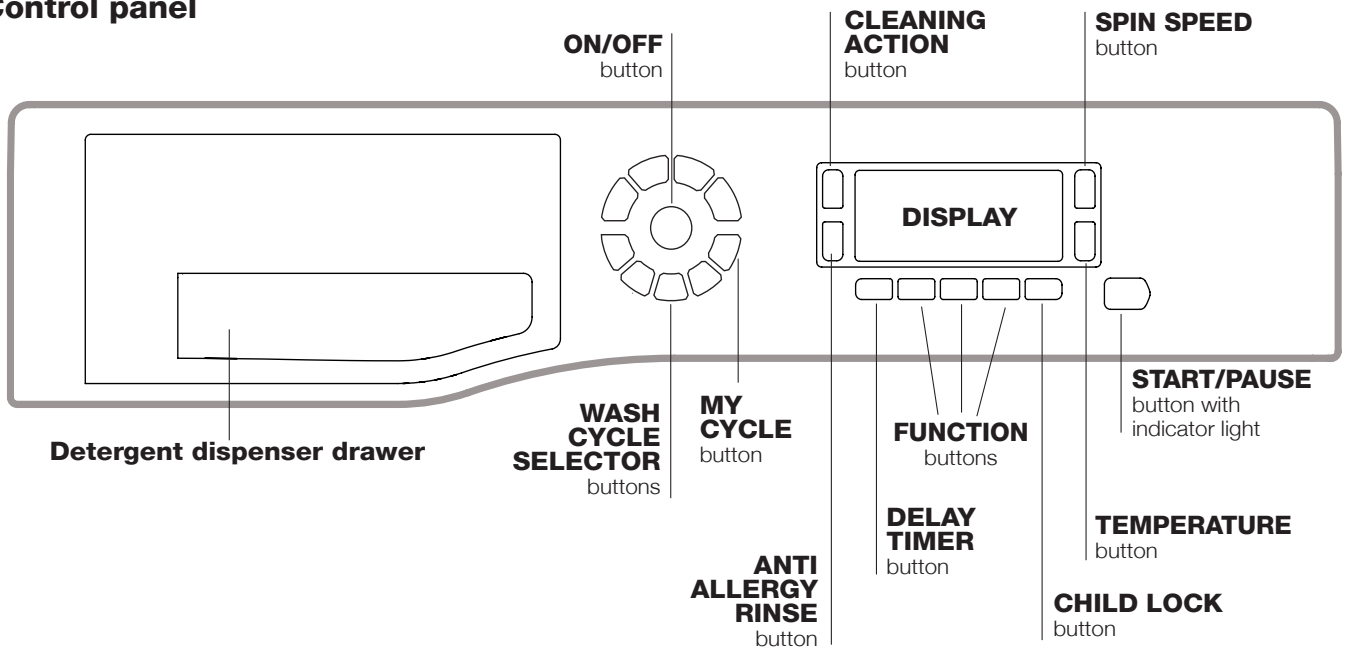

**Detergent dispenser drawer:** used to dispense detergents and washing additives (see “Detergents and laundry”).

**ON/OFF** button : press this briefly to switch the machine on or off. The START/PAUSE indicator light, which flashes slowly in a green colour shows that the machine is switched on. To switch off the washing machine during the wash cycle, press and hold the button for approximately 3 seconds; if the button is pressed briefly or accidentally the machine will not switch off. If the machine is switched off during a wash cycle, this wash cycle will be cancelled.

**WASH CYCLE SELECTOR** buttons: used to set the desired wash cycle (see “Table of wash cycles”).

**MY CYCLE** button: press and hold the button to store a cycle with your own set of preferences in the memory of the machine. To recall a previously stored cycle, press the MY CYCLE button.

**FUNCTION** buttons: press the button to select the desired function. The corresponding indicator light on the display will switch on.

**CLEANING ACTION** button: to select the desired wash intensity.

**ANTI ALLERGY RINSE** button: press to select the desired rinse type.

**SPIN** button : press to reduce or completely exclude the spin cycle - the value is indicated on the display.

**TEMPERATURE** button : press to decrease the temperature: the value will be shown on the display.

**CHILD LOCK** button: to activate the control panel lock, press and hold the button for approximately 2 seconds. When the symbol  is illuminated, the control panel is locked (apart from the ON/OFF button). This means it is possible to prevent wash cycles from being modified accidentally, especially where there are children in the home. To deactivate the control panel lock, press and hold the button for approximately 2 seconds.

**DELAY TIMER** button: press to set a delayed start time for the selected wash cycle. The delay time will be shown on the display.

**START/PAUSE** button with indicator light: when the green indicator light flashes slowly, press the button to start a wash cycle. Once the cycle has started the indicator light will remain lit in a fixed manner. To pause the wash cycle, press the button again; the indicator light will flash in an orange colour. If the symbol  is not illuminated, the door may be opened. To start the wash cycle from the point at which it was interrupted, press the button again.

### Standby mode

This washing machine, in compliance with new energy saving regulations, is fitted with an automatic standby system which is enabled after about 30 minutes if no activity is detected. Press the ON-OFF button briefly and wait for the machine to start up again.

Consumption in off-mode: 0.5 W

Consumption in Left-on: 0.5 W



## Display

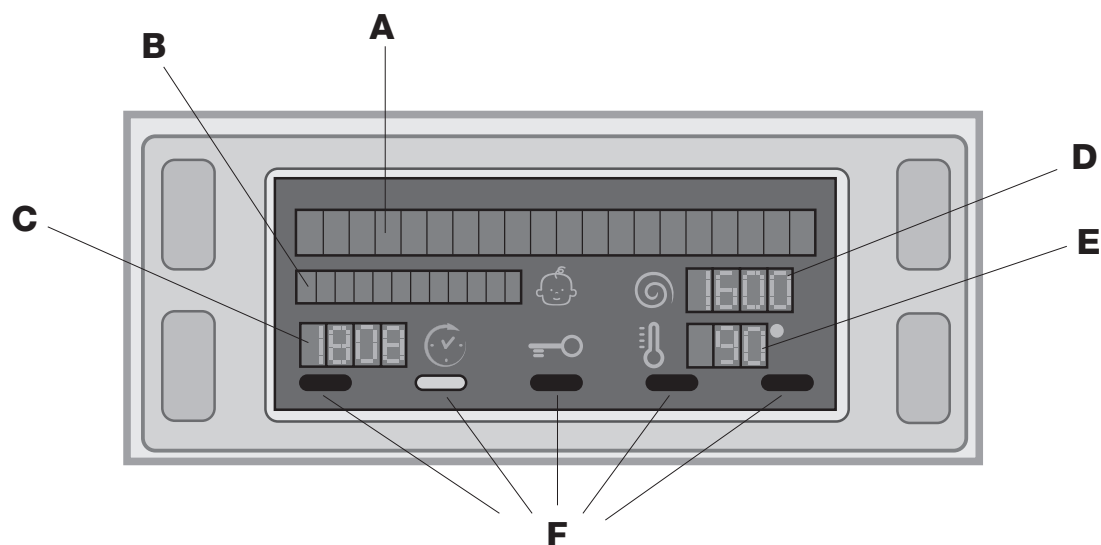

The display is useful when programming the machine and provides a great deal of information.

The two upper strings **A** and **B** provide details of the wash cycle selected, the wash cycle phase in progress and all information relating to the progress status of the wash cycle.

String **C** shows the time remaining until the end of the wash cycle in progress and, if a DELAYED START has been set, the time remaining until the start of the selected wash cycle.

String **D** shows the maximum spin speed value (this depends on the selected wash cycle); if the wash cycle does not include a spin cycle, the string remains unused.

String **E** shows the maximum temperature value which may be selected (this depends on the wash cycle used); if the temperature of the wash cycle cannot be modified, the string remains unused.

Indicator lights **F** correspond to the functions and light up when the selected function is compatible with the set wash cycle.

### Door locked symbol

If the symbol is lit, this indicates that the washing machine door is locked to prevent it from being opened accidentally. To prevent any damage from occurring, wait for the symbol to switch itself off before opening the appliance door.

N.B.: if the DELAY TIMER function has been activated, the door cannot be opened; pause the machine by pressing the START/PAUSE button if you wish to open it.



# Running a wash cycle

GB

1. **SWITCH THE MACHINE ON.** Press the On/Off button ; the text POWER ON will appear on the display and the START/PAUSE indicator light will flash slowly in a green colour.
2. **LOAD THE LAUNDRY.** Open the porthole door. Load the laundry, making sure you do not exceed the maximum load value indicated in the table of programmes on the following page.
3. **MEASURE OUT THE DETERGENT.** Open the detergent dispenser drawer and pour the detergent into the relevant compartments as described in "Detergents and laundry".
4. **CLOSE THE DOOR.**
5. **SELECT THE WASH CYCLE.** Press one of the WASH CYCLE SELECTOR buttons to select the required wash cycle; the name of the wash cycle will appear on the display. A temperature and spin speed is set for each wash cycle; these may be adjusted. The duration of the cycle will appear on the display.
6. **CUSTOMISE THE WASH CYCLE.** Use the relevant buttons:



## Modifying the temperature and/or spin speed.

The machine automatically selects the maximum temperature and spin speed set for the selected wash cycle; these values cannot therefore be increased. The temperature can be decreased by pressing the  button, until the cold wash "OFF" setting is reached. The spin speed may be progressively reduced by pressing the  button, until it is completely excluded (the "OFF" setting). If these buttons are pressed again, the maximum values are restored.

! Exception: if the  (60°) (1st press of the button) programme is selected, the temperature can be increased up to a value of 90°C.

## Setting a delayed start.

To set a delayed start for the selected programme, press the corresponding button repeatedly until the required delay period has been reached. When this option is enabled, the  symbol lights up on the display. To remove the delayed start function press the button until the text "OFF" appears on the display.

## Set the desired wash intensity.

Option "Cleaning Action" makes it possible to optimise washing based on the level of soil in the fabrics and on desired wash cycle intensity.

Select the wash programme: the cycle will be automatically set to "Normal" as optimised for garments with an average level of soil (this setting is not applicable to the "Wool" cycle, which is automatically set to "Delicate"). For heavily-soiled garments press button "Cleaning Action" until the "Super Wash" level is reached. This level ensures a high-performance wash due to a larger quantity of water used in the initial phase of the cycle and due to increased drum rotation. It is useful when removing the most stubborn stains.

For lightly-soiled garments or a more delicate treatment of the fabrics, press button "Cleaning Action" until the "Delicate" level is reached. The cycle will reduce the drum rotation to ensure washing results are perfect for delicate garments.

## Set the rinse type.

Option "Anti Allergy Rinse" makes it possible to select the desired rinse type for sensitive skin. Press the button once for the "Extra Rinse" level, which makes it possible to select an additional rinse after the standard cycle rinse and remove all traces of detergent. Press the button again for the "Sensitive Skin" level, which makes it possible to select two additional rinses to the standard cycle rinses; it is recommended for very sensitive skin. Press the button for the third time for the "Anti allergy Rinse" level, which makes it possible to select three additional rinses to the standard cycle rinses and remove major allergens such as pollen, mites, cat and dog hair. Press the button again to go back to the "Normal Rinse" rinse type. If the current adjustment can be neither set nor changed, the display will show "Not allowed".



## Modifying the cycle settings.

- Press the button to enable the function; the indicator light corresponding to the button will switch on.
- Press the button again to disable the function; the indicator light will switch off.

! If the selected function is not compatible with the programmed wash cycle, the indicator light will flash and the function will not be activated.

! If the selected function is not compatible with another function which has been selected previously, the indicator light corresponding to the first function selected will flash and only the second function will be activated; the indicator light corresponding to the enabled function will remain lit.

! The functions may affect the recommended load value and/or the duration of the cycle.

7. **START THE PROGRAMME.** Press the START/PAUSE button. The corresponding indicator light will become green, remaining lit in a fixed manner, and the door will be locked (the DOOR LOCKED symbol will be on). During the wash cycle, the name of the phase in progress will appear on the display. To change a wash cycle while it is in progress, pause the washing machine using the START/PAUSE button (the START/PAUSE indicator light will flash slowly in an orange colour); then select the desired cycle and press the START/PAUSE button again. To open the door while a cycle is in progress, press the START/PAUSE button; if the DOOR LOCKED  symbol is switched off the door may be opened. Press the START/PAUSE button again to restart the wash cycle from the point at which it was interrupted.
8. **THE END OF THE WASH CYCLE.** This will be indicated by the text "END OF CYCLE" on the display; when the DOOR LOCKED  symbol switches off the door may be opened. Open the door, unload the laundry and switch off the machine.

! If you wish to cancel a cycle which has already begun, press and hold the  button. The cycle will be stopped and the machine will switch off.

# Wash cycles and functions

**Table of wash cycles**

Wash cycles	Description of the wash cycle	Max. temp. (°C)	Max. speed (rpm)	Detergents		Max. load (kg)	Residual dampness %	Energy consumption kWh	Total water lt	Cycle duration
				Wash	Fabric softener					
<b>CLEAN Plus</b>										
	<b>Anti Stain</b>	40°	1200	●	●	5	-	-	-	180'
	<b>Cottons</b> (Standard Cotton 60°) (1st press of the button) <b>(1)</b> : heavily soiled whites and delicate colours.	60° (Max. 90°)	1200	●	●	8	53	1,09	73	200'
	<b>Cottons</b> (Standard Cotton 40°) (2nd press of the button) <b>(2)</b> : lightly soiled whites and delicate colours.	40°	1200	●	●	8	53	1,09	92	185'
	<b>Cottons</b> (Standard Cotton 20°) (3rd press of the button): lightly soiled whites and delicate colours.	20°	1200	●	●	8	-	-	-	175'
	<b>Synthetics</b> (Synthetics Resistant) (1st press of the button): heavily soiled resistant colours.	60°	800	●	●	4.5	46	1,03	60	115'
	<b>Synthetics</b> (Synthetics Resistant) (1st press of the button) <b>(3)</b> : lightly soiled resistant colours.	40°	800	●	●	4.5	46	0,56	60	100'
	<b>Synthetics</b> (Synthetics Delicate) (2nd press of the button): lightly soiled delicate colours.	40°	800	●	●	4.5	-	-	-	75'
<b>SPECIALS</b>										
	<b>Fast Wash 60'</b> (1st press of the button): to refresh normal soiled garments quickly (not suitable for wool, silk and clothes which require washing by hand).	60°	1200	●	●	3.5	53	0,84	44	60'
	<b>Fast Wash 30'</b> (2nd press of the button): to refresh lightly soiled garments quickly (not suitable for wool, silk and clothes which require washing by hand).	30°	800	●	●	3.5	71	0,20	38	30'
	<b>My Cycle</b> (Memory): allows for any wash cycle to be stored.									
	<b>Bed&amp;Bath</b> : washes bathroom laundry and bedlinen.	60°	1200	●	●	8	-	-	-	140'
<b>EXTRAS</b>										
	<b>Wool</b> (Woolmark Platinum): for wool, cashmere, etc.	40°	800	●	●	2	-	-	-	90'
	<b>Delicates</b>	30°	0	●	●	1	-	-	-	80'
	<b>Spin</b> (1st press of the button)	-	1200	-	-	8	-	-	-	16'
	<b>Rinse</b> (2nd press of the button)	-	1200	-	●	8	-	-	-	36'
	<b>Pump out</b> (3rd press of the button)	-	0	-	-	8	-	-	-	2'

The length of cycle shown on the display or in this booklet is an estimation only and is calculated assuming standard working conditions. The actual duration can vary according to factors such as water temperature and pressure, the amount of detergent used, the amount and type of load inserted, load balancing and any wash options selected.

- 1) Test wash cycle in compliance with directive 1061/2010: set wash cycle with a temperature of 60°C (1st press of the button).**  
This cycle is designed for cotton loads with a normal soil level and is the most efficient in terms of both electricity and water consumption; it should be used for garments which can be washed at 60°C. The actual washing temperature may differ from the indicated value.
- 2) Test wash cycle in compliance with directive 1061/2010: set wash cycle with a temperature of 40°C (2nd press of the button).**  
This cycle is designed for cotton loads with a normal soil level and is the most efficient in terms of both electricity and water consumption; it should be used for garments which can be washed at 40°C. The actual washing temperature may differ from the indicated value.

For all Test Institutes:

- 2) Long wash cycle for cottons: set wash cycle with a temperature of 40°C (2nd press of the button).**
- 3) Long wash cycle for synthetics: set wash cycle 60°C (1st press of the button); with a temperature of 40°C (press TEMPERATURE button).**

## Wash functions

### Time Saver

If you select this option, the wash cycle duration will be reduced by up to 50%, depending on the selected cycle, thereby guaranteeing simultaneous water and energy saving. Use this cycle for lightly soiled garments.

! It cannot be used with the , "Fast Wash 60'", , , .

### Reduced Creases

By selecting this function, the wash and spin cycles will be modified in order to reduce the formation of creases.

At the end of the cycle the washing machine will perform slow rotations of the drum; the "Reduced Creases" and START/PAUSE indicator lights will flash (orange) and the text "END OF CYCLE" will appear on the display. To end the cycle, press the START/PAUSE button or the "Reduced Creases" button.

! It cannot be used with the , "Fast Wash 30'", , , .

### Eco Wash

The Eco Wash function saves energy by not heating the water used to wash your laundry – an advantage both to the environment and to your energy bill. Instead, intensified wash action and water optimisation ensure great wash results in the same average time of a standard cycle. For the best washing results we recommend the usage of a liquid detergent.

! It cannot be used with the , , , , , .

# Detergents and laundry

GB

## Detergent dispenser drawer

Good washing results also depend on the correct dose of detergent: adding too much detergent will not necessarily result in a more efficient wash, and may in fact cause a build up on the inside of your appliance and contribute to environmental pollution.

! Use powder detergent for white cotton garments, for pre-washing, and for washing at temperatures over 60°C.

! Follow the instructions given on the detergent packaging.

! Do not use hand washing detergents because these create too much foam.

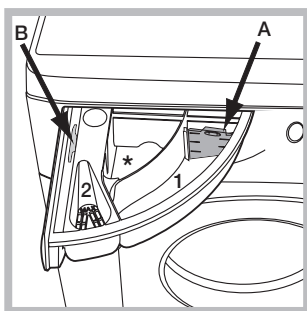

Open the detergent dispenser drawer and pour in the detergent or washing additive, as follows.

! Do not pour detergent into the middle compartment (\*). Detergent should only be poured into the compartment 1.

### compartment 1: Detergent for the wash cycle (powder or liquid)

If liquid detergent is used, it is recommended that the removable plastic partition A (supplied) be used for proper dosage.

If powder detergent is used, place the partition into slot B.

### compartment 2: Additives (fabric softeners, etc.)

The fabric softener should not overflow the grid.

## Preparing the laundry

- Divide the laundry according to:
  - the type of fabric/the symbol on the label
  - the colours: separate coloured garments from whites.
- Empty all garment pockets and check the buttons.
- Do not exceed the values listed in the "Table of wash cycles", which refer to the weight of the laundry when dry.

### How much does your laundry weigh?

- 1 sheet 400-500 g
- 1 pillow case 150-200 g
- 1 tablecloth 400-500 g
- 1 bathrobe 900-1200 g
- 1 towel 150-250 g

## Special wash cycles

**Anti Stain** : this programme is suitable to heavily-soiled garments with resistant colours. It ensures a washing class that is higher than the standard class (A class). When running the programme, do not mix garments of different colours. We recommend the use of powder detergent. Pre-treatment with special additives is recommended if there are obstinate stains.

**Cotton Standard 20°** : this programme is ideal for heavily soiled cotton loads. The effective performance levels achieved at cold temperatures, which are comparable to washing at 40°, are guaranteed by a mechanical action which operates at varying speed, with repeated and frequent peaks.

**Bed&Bath:** use programme  to wash bed linen and towels in one single cycle: it optimises softener performance and helps you save time and energy. We recommend the use of powder detergent.

**Wool:** the wool wash cycle on this Hotpoint machine has been tested and approved by The Woolmark Company for washing wool garments labelled as hand washable provided that the garments are washed according to the instructions on the garment label and those issued by the manufacturer of this washing machine. Hotpoint is the first washing machine brand to be approved by The Woolmark Company for Apparel Care- Platinum for its washing performance and consumption of energy and water. (M1127)



In UK, Eire, Hong Kong and India the Woolmark trade mark is a Certification trade mark.

**Delicates:** use programme  to wash very delicate garments with decorative features, such as diamantes and sequins.

To wash **silk** garments and **curtains** select the cycle  and set the "Delicate" level from option "Cleaning Action". We recommend turning the garments inside out before washing and placing small items into the special bag for washing delicates. Use liquid detergent on delicate garments for best results.

## Load balancing system

Before every spin cycle, to avoid excessive vibrations and to distribute the load in a uniform manner, the drum rotates continuously at a speed which is slightly greater than the washing rotation speed. If, after several attempts, the load is not balanced correctly, the machine spins at a reduced spin speed. If the load is excessively unbalanced, the washing machine performs the distribution process instead of spinning. To encourage improved load distribution and balance, we recommend small and large garments are mixed in the load.

Your washing machine could fail to work. Before contacting the Technical Assistance Centre (see “Assistance”), make sure that the problem cannot be solved easily using the following list.

<b>Problem:</b>	<b>Possible causes / Solutions:</b>
<b>The machine does not switch on.</b>	<ul style="list-style-type: none"><li>• The appliance is not plugged into the socket fully, or not enough to make contact.</li><li>• There is no power to the socket, or the fuse has blown in the mains plug.</li></ul>
<b>The wash cycle does not start.</b>	<ul style="list-style-type: none"><li>• The door is not closed properly.</li><li>• The ON/OFF button has not been pressed.</li><li>• The START/PAUSE button has not been pressed.</li><li>• The water tap has not been turned on to allow water to flow into the machine.</li><li>• A delayed start has been set (see “Running a wash cycle”).</li></ul>
<b>The machine does not fill with water or “NO WATER CHECK SUPPLY” appears on the display.</b>	<ul style="list-style-type: none"><li>• The water inlet hose is kinked.</li><li>• The water inlet hose is not connected to the water supply.</li><li>• The water pressure is too low.</li><li>• The water tap has not been turned on to allow water to flow into the machine.</li><li>• There is no water supply to the house.</li><li>• The inlet valve filter is blocked.</li><li>• The START/PAUSE button has not been pressed.</li></ul>
<b>The machine continuously fills with water and continually drains away or Water left in the drum or Stuck on wash.</b>	<ul style="list-style-type: none"><li>• The top of the drain hose is too low - It must be fitted at a height between 65 and 100 cm from the floor (see “Installation”).</li><li>• The drain hose is connected incorrectly to the sink trap allowing water to run into the machine, the drain hose must be positioned higher than the bottom of the sink to prevent water flowing down the drain hose.</li><li>• The end of the drain hose has been pushed too far down the standpipe, the ‘U’ bracket should be fitted 100 mm from the end of the drain hose.</li></ul>
<b>The machine does not drain or spin or F05 error code in the display.</b>	<ul style="list-style-type: none"><li>• The Pump filter is blocked.</li><li>• The drain hose is kinked (see “Installation”).</li><li>• New Installation - The blanking cap or spigot has not been removed if connected under a sink.</li><li>• The drain hose or sink trap is blocked.</li><li>• The wash cycle does not include draining, some wash cycles require the drain phase to be started manually.</li><li>• The “Reduced Creases” function button has been activated. To complete the wash cycle, press the START/PAUSE button (see “Wash cycles and functions”).</li><li>• The ‘Spin Speed’ is in the “OFF” position.</li></ul>
<b>The machine does not heat or poor wash results.</b>	<ul style="list-style-type: none"><li>• The ‘Temperature’ is in the “OFF” position.</li></ul>
<b>The programme takes too long or The Display changes the estimated ‘Time to End’ during the programme.</b>	<ul style="list-style-type: none"><li>• Programme times will vary due to water pressure, the incoming water temperature and if the wash load goes out of balance. This will increase the programme times accordingly (see ‘The machine won’t spin properly’ below).</li></ul>
<b>The machine vibrates a lot during the spin cycle.</b>	<ul style="list-style-type: none"><li>• The feet have not been adjusted, enabling the machine to rock.</li><li>• New Installation - Either the Transit Bolts including the plastic spacers, or the Polystyrene Packaging have not been removed when installing the machine.</li><li>• The machine is trapped between cabinets and/or walls.</li><li>• The load is in a slight out of balance condition and machine is spinning, but at a lower speed.</li></ul>

**The machine is noisy.**

- There will always be some motor, pump and drum noise during spin.

**The machine wont spin properly.**

- Out of Balance detected when attempting to go into a spin cycle - If this happens the machine will continue to try to repeat the distribution of the load required before the machine will go into higher spin speeds - This will increase the programme time accordingly. This is a safety feature to prevent damage. Out of Balance can be caused by washing a single heavy item (eg duvet, quilt, etc). - Try the programme again using a different load.

**The machine leaks from the dispenser.**

- The dispenser drawer is blocked with detergent and requires cleaning.
- The water pressure is too high and requires turning down - turn down the tap on the water supply pipe slightly and try again.
- The machine is tilting forwards - It must be level when in its final position.

**The machine leaks (other than dispenser).**

- The fill hose is loose, check both the cabinet and tap ends.
- The fill hose is tight but still leaks, if so replace the rubber washers, or the fill hose is missing the rubber washer.
- The drain hose is not fixed in properly.

**The indicator lights on the console are flashing rapidly.**

- Switch off the machine and unplug it, wait for approximately 1 minute and then switch it back on again If the problem persists contact the Technical Assistance Service.

**The machine smells.**

- The machine requires a service wash. Run a "Auto Clean" wash cycle with detergent and no laundry

**The machine door cannot be opened.**

- The door will not open until the door lock indicator light goes out shortly after the program has finished.

**Door Seal damaged at the bottom.**

- The door seal has drainage holes at the bottom - This is normal.

**The water level is too low when the machine is washing.**

- The water level is correct if it can be seen at the bottom of the door.

**There is too much foam.**

- The detergent is not suitable for machine washing (it should display the text 'for washing machines' or 'hand and machine wash' or the like).
- Too much detergent was used - less detergent is required in soft water.

**After completing the programme, or before starting a programme, the machine has turned itself off (no lights).**

- To comply with new energy saving regulations the machine is fitted with an automatic standby system. Press 'ON/OFF' button for 3 seconds to activate the machine, it can then either be switched off or a new programme selected.

**General.**

- Your washing machine contains sensors that monitor progress during the wash cycle (eg: Water Levels, Temperatures, Out of Balance loads, Wash time/progress). Normally, if your machine successfully completes the cycle, there is unlikely to be anything wrong!

**Remember, you will be charged for a service call for problems caused by incorrect installation, as listed above.**

**Not emptying contents from pockets may cause pump or drain blockages, or may damage the machine. Do not wash items which do not have a wash label, or wash items that are not intended as machine washable.**

## Guarantee

### 12 Months Parts and Labour Guarantee

Your appliance has the benefit of our manufacturer's guarantee, which covers the cost of breakdown repairs for twelve months from the date of purchase.

This gives you the reassurance that if, within that time, your appliance is proven to be defective because of either workmanship or materials, we will, at our discretion, either repair or replace the appliance at no cost to you.

This guarantee is subject to the following conditions:

- The appliance has been installed and operated correctly and in accordance with our operating and maintenance instructions.
- The appliance is used only on the electricity or gas supply printed on the rating plate.
- The appliance has been used for normal domestic purposes only.
- The appliance has not been altered, serviced, maintained, dismantled, or otherwise interfered with by any person not authorised by us.
- Any repair work must be undertaken by us or our appointed agent.
- Any parts removed during repair work or any appliance that is replaced become our property.
- The appliance is used in the United Kingdom or Republic of Ireland.

The guarantee **does not cover:**

- Damage resulting from transportation, improper use, neglect or interference or as a result of improper installation.
- Replacement of any consumable item or accessory . These include but are not limited to: plugs, cables, batteries, light bulbs, fluorescent tubes and starters, covers and filters.
- Replacement of any removable parts made of glass or plastic.

**THIS GUARANTEE WILL NOT APPLY IF THE APPLIANCE HAS BEEN USED IN COMMERCIAL OR NON-DOMESTIC PREMISES.**

### 5 Year Parts Guarantee

Hotpoint also offers you a free 5 year parts guarantee. This additional guarantee is conditional on you registering your appliance with us and the parts being fitted by one of our authorised engineers. There will be a charge for our engineer's time. To activate the extra parts warranty on your appliance, simply call our registration line on **08448 24 24 24 (ROI 01 230 0800)**.

### Extended Guarantees

We offer a selection of repair protection plans that enable you to fully cover yourself against the expense of repair bills for the life of your policy. To find the ideal plan for you please call our advice line on **08448 226 226 (Republic of Ireland 01 230 0233)**.

### Free Helpdesk Service

We have a dedicated team who can provide free advice and assistance with your appliance if you experience any technical difficulties within the first 90 days of ownership. Simply call our Hotpoint Service Hotline on **08448 224 224 (Republic of Ireland 0818 313 413)** for telephone assistance, or, where necessary, to arrange for an engineer to call. If we cannot resolve the technical problem we will replace your machine or, if you prefer, give you your money back.

## After Sales Service

**No one is better placed to care for your Hotpoint appliance during the course of its working life than us - the manufacturer.**

### Essential Contact Information

#### Hotpoint Service

We are the largest service team in Europe offering you access to 400 skilled telephone advisors and 1000 fully qualified engineers on call to ensure you receive fast, reliable, local service.

**UK: 08448 224 224**

**Republic of Ireland: 0818 313 413**

**[www.hotpointservice.co.uk](http://www.hotpointservice.co.uk)**

**Please note: Our advisors will require the following information:**

**Model number:**

**Serial number:**

#### Parts and Accessories

We supply a full range of genuine replacement parts as well as accessory products that protect and hygienically clean your appliance to keep it looking good and functioning efficiently throughout its life.

**UK: 08448 225 225**

**Republic of Ireland: 0818 313 413**

**[www.hotpointservice.co.uk](http://www.hotpointservice.co.uk)**

#### Appliance Registration

We want to give you additional benefits of Hotpoint ownership. To activate your free 5 year parts guarantee you must register your appliance with us.

**UK: 08448 24 24 24**

**Republic of Ireland: 01 230 0800**

**[www.hotpointservice.co.uk](http://www.hotpointservice.co.uk)**

**Indesit Company UK Ltd. Morley Way, Peterborough, PE2 9JB**

Indesit Company Unit 49 Airways Industrial Estate, Dublin 17



### Recycling & Disposal Information

As part of Hotpoint's continued commitment to helping the environment, Hotpoint reserves the right to use quality, recycled components to keep down customer costs and minimise material wastage.

Please dispose of packaging and old appliances carefully. To minimise the risk of injury to children, remove the door, plug and cut the mains cable off flush with the appliance. Dispose of these parts separately to ensure that the appliance can no longer be plugged into a mains socket, and the door