

Industrial Color Camera
GP-UR612

Operating Instructions



(Lens : Purchased locally)

Panasonic®

Before attempting to connect or operate this product,
please read these instructions completely.

	CAUTION RISK OF ELECTRIC SHOCK DO NOT OPEN	
<p>CAUTION: TO REDUCE THE RISK OF ELECTRIC SHOCK, DO NOT REMOVE COVER (OR BACK). NO USER SERVICEABLE PARTS INSIDE. REFER SERVICING TO QUALIFIED SERVICE PERSONNEL.</p>		



SA 1965

The lightning flash with arrowhead symbol, within an equilateral triangle, is intended to alert the user to the presence of uninsulated "dangerous voltage" within the product's enclosure that may be of sufficient magnitude to constitute a risk of electric shock to persons.



SA 1966

The exclamation point within an equilateral triangle is intended to alert the user to the presence of important operating and maintenance (servicing) instructions in the literature accompanying the appliance.

WARNING:

TO PREVENT FIRE OR SHOCK HAZARD, DO NOT EXPOSE THIS APPLIANCE TO RAIN OR MOISTURE.

For U.S.A.

Warning:

This equipment generates and uses radio frequency energy and if not installed and used properly, i.e., in strict accordance with the instruction manual, may cause harmful interference to radio communications. It has been tested and found to comply with the limits for a Class A computing device pursuant to Subpart J of Part 15 of FCC Rules, which are designed to provide reasonable protection against such interference when operated in a commercial environment.

For CANADA

This digital apparatus does not exceed the Class A limits for radio noise emissions from digital apparatus set out in the Radio Interference Regulations of the Canadian Department of Communications.

The serial number of this product may be found on the bottom of the unit.

You should note the serial number of this unit in the space provided and retain this book as a permanent record of your purchase to aid identification in the event of theft.

Model No. _____

Serial No. _____

CONTENTS

PREFACE	2
FEATURES	2
SPECIAL NOTES ON OPERATION	3
PRECAUTIONS	4
MAJOR OPERATING CONTROLS AND THEIR FUNCTIONS	6
VD RESET ON/OFF SETTING	11
LENS MOUNTING	11
FLANGE BACK ADJUSTMENT	12
IRIS GAIN CONTROL IN A LENS	12
AUTOMATIC IRIS ADJUSTMENT	12
CONNECTIONS	13
ADJUSTMENT	20
MENU ITEM SETTING	26
INITIAL SET MENU SETTING	28
USER SETUP MENU SETTING	35
INSTALLATIONS	40
INSTALLATION OF CAMERA WITH MOUNTING BRACKET	41
CAMERA ID SETTING	41
TIME DATE SETTING	44
RANGE OF SETUP/INITIAL SET AND THEIR INITIAL VALUES	46
SPECIFICATIONS	48
STANDARD ACCESSORIES	49
OPTIONAL ACCESSORIES	49

PREFACE

The Panasonic GP-UR612 is a digital signal processing color video camera that incorporates three 1/2" CCDs. A digital video signal processing system is packed in a compact, lightweight body while assuring high picture quality, high reliability and high performance.

System setup and adjustments can be easily performed by SETUP menu.

Connection to peripheral devices, such as an RCU and an RCB, enables a wide variation of system configurations.

FEATURES

1. Digital video signal processing for high quality, high reliability, high performance, lightweight and compact size.
2. Resolution: 550 lines (at center), S/N ratio: 62dB
3. Minimum illumination: 7 lux (F1.4, +18dB)
4. SETUP menu for system check and readjustments.
5. Built-in automatic controls, including ATW and AGC
6. CCD readout is switchable between field and frame modes. Vertical resolution can be stepped up in frame mode and it is effective for shooting still objects.
7. Any of R/G/B, Y/C, Y/PB/PR and composite signal can be selected as an output signal.
8. Various correction circuits permit video reproduction with highest fidelity.
9. Chroma aperture correction enables clear shots of dark color objects.
10. 2 Dimensional lowpass filter reduces spurious signals.
11. A dark detail circuit provides natural edge correction to any object in a dark scene.
12. A digital highlight compression circuit reproduces natural dynamic ranges.
13. A digital color matrix enables high fidelity color images.

14. VD reset mode is available.
15. The scene file automatically sets up the most appropriate shooting conditions.
16. System setup parameters, such as SMPTE/full color bar, date and time are indicated on the monitor screen.
17. Remote control with an RCU or RCB.

SPECIAL NOTES ON OPERATION

- Turn power off before connecting or disconnecting cables.
 - Connection or disconnection of any studio cable, RCB cable or other cable to any unit of equipment must be performed while power is off.
 - While the camera is automatic mode; The ATW function under fluorescent illumination can adversely change the white balance.
 - This camera is preset to VD reset ON mode at factory. Do refer any servicing or installation to qualified service personnel or system installers.
-
- **Function of VD RESET mode;**
1 field or 1 frame of video signal can be obtained by supply the HD and VD RESET pulses to the camera. If not supply the VD RESET pulse, low level of video signal is output.
Adjust the focus, zoom and iris of the lens while supplying the VD RESET pulse continuously.
When setting the MENU items on the monitor screen, do not supply the VD RESET pulse to the camera.

PRECAUTIONS

DONT'S

- Do not attempt to disassemble the camera, Remote Control Unit (RCU) or other units. In order to prevent electric shock, do not remove screws or covers. There are no user-serviceable parts inside.
- Do not abuse the camera. Avoid striking, shaking, etc. The camera contains sensitive components which could be damaged by improper handling or storage.
- Do not let the lens remain uncapped when the camera is not in use. If the lens is not installed, do not leave the lens mount hole uncovered.
- Do not touch the surface of the lens or prism with your fingers.
- Do not use strong or abrasive detergents when cleaning the camera body.

DO'S

- Do refer any servicing to qualified service personnel.
- Do handle the camera with care.
- Do protect the precision made lens by placing the lens cap over the lens when the camera is not in use. If the lens is not installed, protect the surface of the prism by placing the body cap into the lens mount hole.
- Do use a mild blower or lens cleaning tissue designed for coated lenses, to clean the surface of the lens or prism in the event that it should become dirty.
- Do use a dry cloth to clean the camera if it is dirty. In case the dirt is hard to remove, use mild detergent and wipe gently.

- Do not aim the camera toward the sun, no matter whether it is turned on or not.
- Do not expose the camera or Remote Control Unit (RCU) to rain or moisture, and do not try to operate the equipment in wet areas. Do not operate the camera or RCU if it becomes wet.
- Do not operate the camera or Remote Control Unit (RCU) outdoors during a lightning storm.
- Do not use the camera in an extreme environment where high temperatures or high humidity exist.
- Do not leave the camera and Remote Control Unit (RCU) turned on when not in use. Do not unnecessarily turn the camera power on and off repeatedly. Do not block the ventilation slots.
- Do use caution when operating the camera in the vicinity of spot lights or other bright lights, as well as light reflecting objects and surfaces.
- Do take immediate action if ever the camera or RCU should become wet. Turn the power off and have the unit checked by an authorized service facility.
- Do follow normal safety precautions to avoid personal injury.
- Use the camera in an environment where the temperature is within 14°F - 113°F (-10°C - +45°C), and the relative humidity is within 30% - 90%.
- Always turn the power off when the camera is not going to be used. Operate the camera and Remote Control Unit (RCU) only when there is adequate ventilation.

MAJOR OPERATING CONTROLS AND THEIR FUNCTIONS

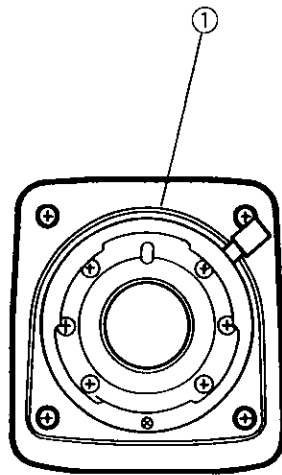

<Front View>

<Top View>

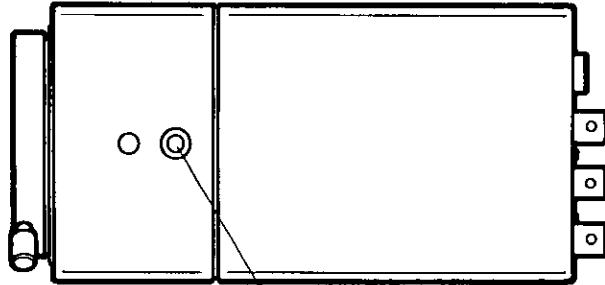

<Bottom View>

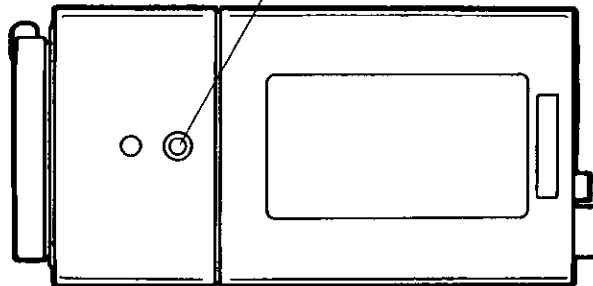

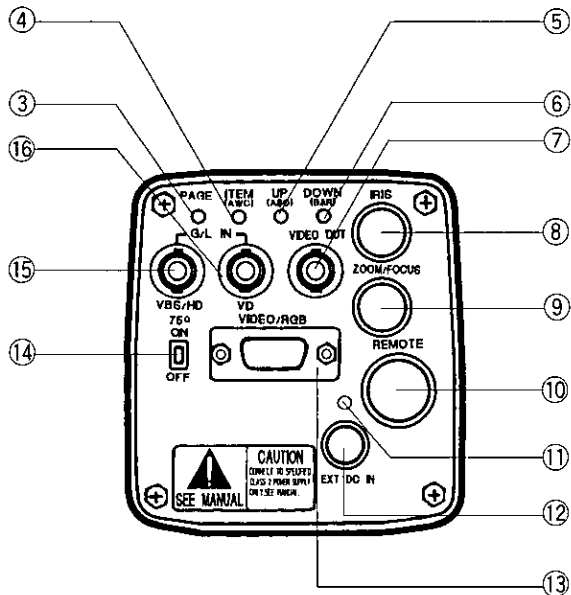

1. Lens Mount

1/2" standard bayonet type lens or a microscope adaptor can be mounted.

2. Mounting Hole

A screw hole (1/4" - 20 UNC) for mounting the camera on a wall, ceiling with a mounting bracket or tripod.

3. Page Switch (PAGE)

A menu will appear on the monitor screen when this switch is pressed for around 2 seconds. Pressing the switch advances the menu page.

4. Item Switch (ITEM/AWC)

Any of the items shown in the menu can be selected with this switch. When the menu is not displayed or the camera is in shooting mode, the automatic white balance control can be set with this switch.

5. Up Switch (UP/ABC)

While the menu is displayed, any setting can be brought up to a higher value with this switch. When the menu is not displayed or the camera is in shooting mode, the automatic black balance control can be set.

6. Down Switch (DOWN/BAR)

While the menu is displayed any setting can be brought down to a lower value with this switch. When the menu is not displayed or the camera is in shooting mode, the color bar and the shooting conditions are alternately indicated by pressing the switch.

7. Video Output Connector (VIDEO OUT)

A composite video signal is provided at this connector.

8. Iris Connector (IRIS)

Input terminal for lens with an iris control function. Some lenses may require an optional lens extension cable for connection.

Pin No.	Signal	Pin No.	Signal
1	Not Used	7	Iris F
2	Not Used	8	Auto/Remote Control
3	GND	9	Not Used
4	Auto/Manual Control	10	Not Used
5	Iris Control	11	Not Used
6	Lens P	12	Not Used

Iris Connector (IRIS)

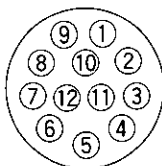

<Front View>

9. Zoom/Focus Connector (ZOOM/FOCUS)

Input terminal for lens with zoom and focus function that can be remote controlled.

Pin No.	Signal	Pin No.	Signal
1	Not Used	7	Voltage Common
2	Not Used	8	Focus Control
3	GND	9	Zoom Control
4	Not Used	10	Not Used
5	Not Used	11	Lens +V
6	+12 V	12	Lens -V

Zoom/Focus Connector (ZOOM/FOCUS)

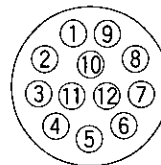

<Front View>

10. Remote Connector (REMOTE)

Input terminal dedicated to control signals from the optional Remote Control Box (WV-CB700A) and the Remote Control Unit (WV-RC700A).

- * WV-CB700A is connected through the optional conversion cable (WV-CA20T10).
- * WV-RC700A is connected through the optional conversion cable (WV-CA26T20).

Pin No.	Signal	Pin No.	Signal
1	Composite Video Output	11	RCB Transmission
2	GND	12	Control (Command)
3	G/Y/Y Output	13	+9.2 V RCB
4	R/PR/C Output	14	DC 12 V Output
5	GND	15	DC 12 V Input
6	RCB Detect	16	DC 12 V Input
7	EXT SUB In	17	RCB Reception
8	B/PB Output	18	GND
9	GND	19	GND
10	G/L Input	20	VD reset A/M Control

Remote Connector (REMOTE)

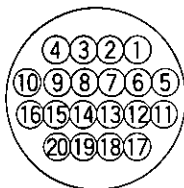

<Front View>

11. Power Indicator

Red LED lamp lights to indicate that the specified DC power is supplied to the camera.

12. DC Input Connector (EXT DC IN)

12 V DC, 2A is supplied through the 4-pin connector provided with the camera.

Pin No.	Signal
1	+12 V In
2	+12 V In
3	Ground
4	Ground

DC Input Connector (EXT DC IN)

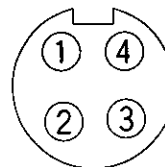

<Front View>

13. Video/RGB Output Connector (VIDEO/RGB)

Composite/Y signal, RGB/Y-C/Y/PB/PR signal and synchronizing signal are output from this connector.

* Refer to Page 32 for signal selection.

The optional cable WV-CA9T5 or WV-CA9T9 must be used for connection to this connector.

Pin No.	Signal	Pin No.	Signal
1	GND	6	Y/COMP
2	GND	7	SYNC
3	R/PR/C	8	GND
4	G/Y/Y	9	C/NC
5	B/PB/NC		

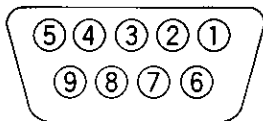

<Front View>

14. G/L Signal 75-ohm ON/OFF Switch (75Ω ON/OFF)

A terminating switch for G/L signals at G/L input connectors (VBS/HD and VD).

15. G/L VBS/HD Input Connector (G/L IN - VBS/HD)

Signals synchronized with the reference signal are to be supplied to this connector when the camera is to be synchronized with the reference signal. VBS/BB, VS and HD signals are to be automatically determined.

Supply the HD signal for VD reset mode.

16. G/L VD Input Connector (G/L IN - VD)

Supply the VD reset pulse for VD reset mode.

VD RESET ON/OFF SETTING

Caution: The following setting should be done by qualified service personnel or system installers. Refer any servicing to qualified service personnel.

- This camera is preset to VD Reset ON mode at factory. Change the position of VD reset on/off selection switch to OFF position for VD Reset OFF mode.

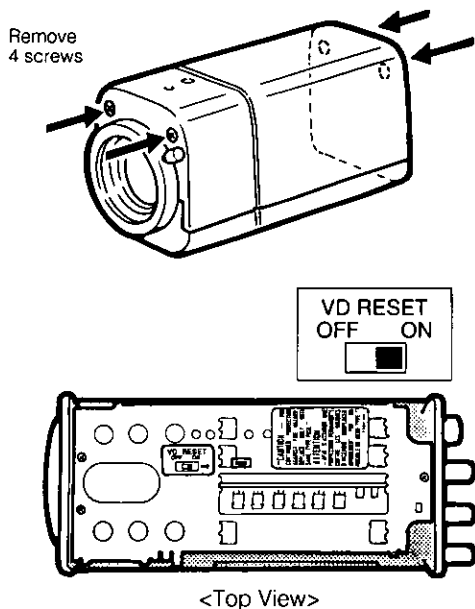

LENS MOUNTING

Lenses of any make can be mounted on the camera as long as they are equipped with a 1/2" standard bayonet.

1. Mounting

Rotate the lens fixing ring knob counterclockwise and remove the lens mount cap. Mount the lens on the camera and rotate the lens fixing ring knob clockwise in order to fix the lens securely. Then connect the lens cable to the IRIS Connector on the back panel of the camera.

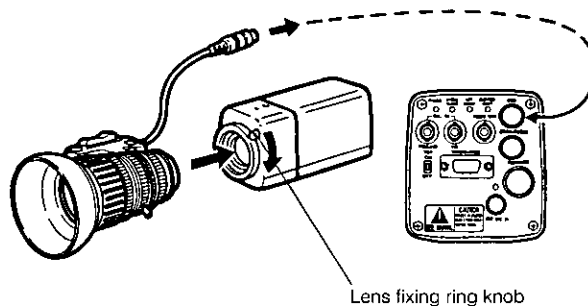

- * Use the lens extension cable WV-CA12T12 (6"/15cm) if your lens cable is too short.

FLANGE BACK ADJUSTMENT

1. Fully open the iris by shooting a dark object. (Iris selection switch should be set to M.)
 2. Loosen the flange back lock knob.
 3. Aim the camera at any object over 2 meters away from the camera.
 4. Set the lens to its TELE end first and adjust its focus with the focus ring.
 5. Set the lens to its widest angle next and adjust its focus with the flange back adjust ring.
 6. Adjust the focus ring and the flange back adjust ring alternately for the best focus within the zooming range.
Tighten the flange back lock knob upon completion of focusing.
 7. Turn the iris selection switch to Position A.
- * The figure represents Lens PH15X7BKRS2U.

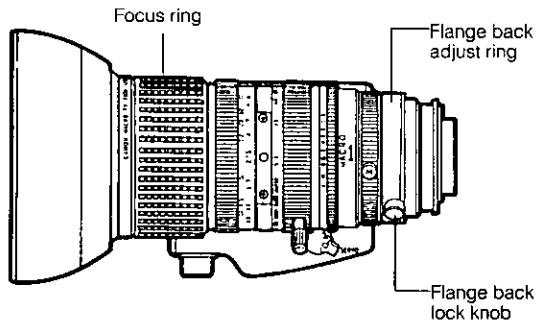

IRIS GAIN CONTROL IN A LENS

An iris gain control hole is usually provided in the front of a lens. Adjustment of the iris gain, with a screwdriver through the hole may be done as follows. (Shape and location of the hole may vary depending on the lens type.)

- 1 Turn the iris selection switch to Position A (AUTO).
- 2 Rotate the iris gain control to the maximum gain but in a range where no hunting or oscillating of the iris ring develops.

* The figure represents Lens PH15X7BKRS2U.

Iris gain control

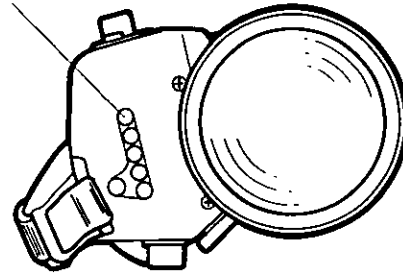

Automatic iris power zoom lens

AUTOMATIC IRIS ADJUSTMENT

When install or change the lens, automatic iris adjustment should be done before operation.
Refer to page 23 for the details.

CONNECTIONS

Caution : The connection and installation should be done by qualified service personnel or system installers Refer any servicing to qualified service personnel.

■ CONNECTION FOR VD RESET MODE

1. VD Reset Mode (Automatic)

Make connections as follows.

WV-CA9T5 Cable Information

Pin No.	Wire's Color	Output Signal
3	Red	R/PR/C
4	Green	G/Y
5	Blue	B/PB
6	White	Y/COMP
7	Black	SYNC

Cautions

1. Connect this to a 12V DC class 2 power supply only.
2. To prevent fire or shock hazard, the UL listed wire VW-1, style 1007 should be used as for the cable for 12V DC Input Connector.

NOTE:

- Make sure that VD RESET ON/OFF switch on the sync board to ON position.
- Output signals at the VIDEO/RGB connector can be selected from the INITIAL SET menu displayed on the monitor screen.
- Sync level can be selected from the INITIAL SET menu displayed on the monitor screen.

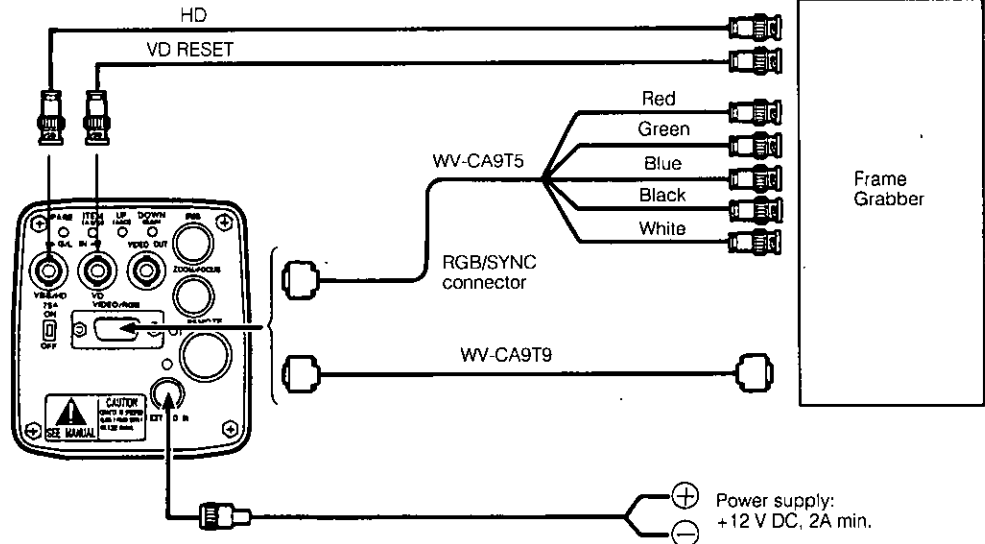

2. VD Reset Mode (Manual)

Make connection as follows.

Cautions

1. Connect this to a 12V DC class 2 power supply only.
2. To prevent fire or shock hazard, the UL listed wire VW-1, style 1007 should be used as for the cable for 12V DC Input Connector.

NOTE:

- Make sure that VD RESET ON/OFF switch on the sync board to ON position.
- Output signals at the VIDEO/RGB connector can be selected from the INITIAL SET menu displayed on the monitor screen.
- Sync level can be selected from the INITIAL SET menu displayed on the monitor screen.

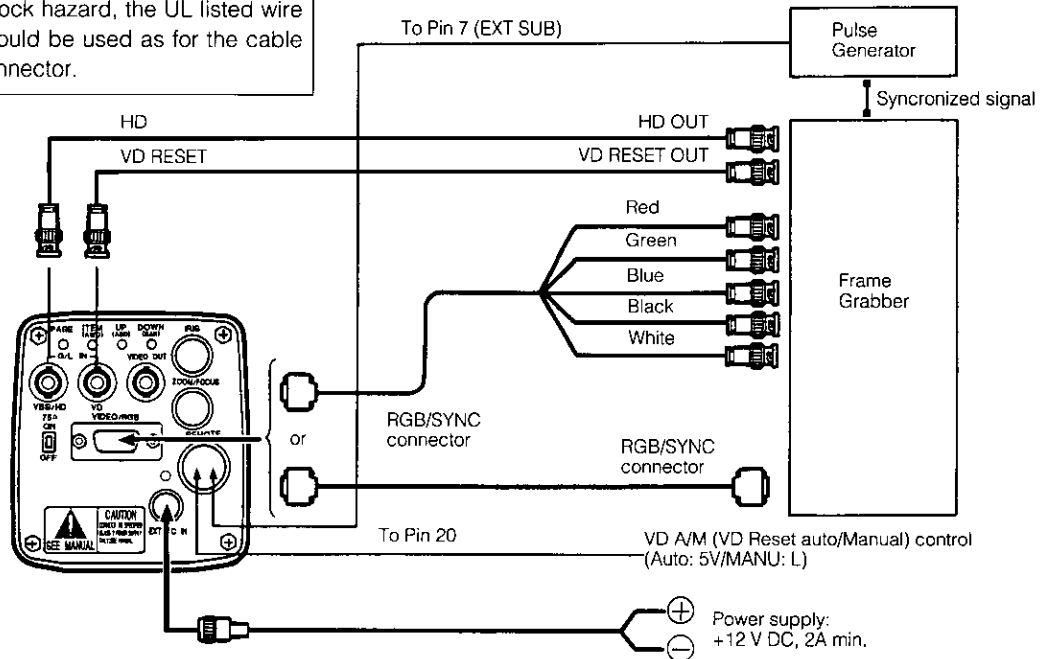

■ CONNECTION OF DEVICE WITH A COMPOSITE INPUT CONNECTOR

- Connection to any device which has a composite input connector, such as a video monitor or a VCR, must be made through the VIDEO OUT Connector.
- Power supply to the camera must be through a power cable assembled with the connector provided with the camera.
- Power source must be able to continuously supply 12 V DC, 2A nominally.
- Set the VD RESET ON/OFF switch on the sync board to OFF position.

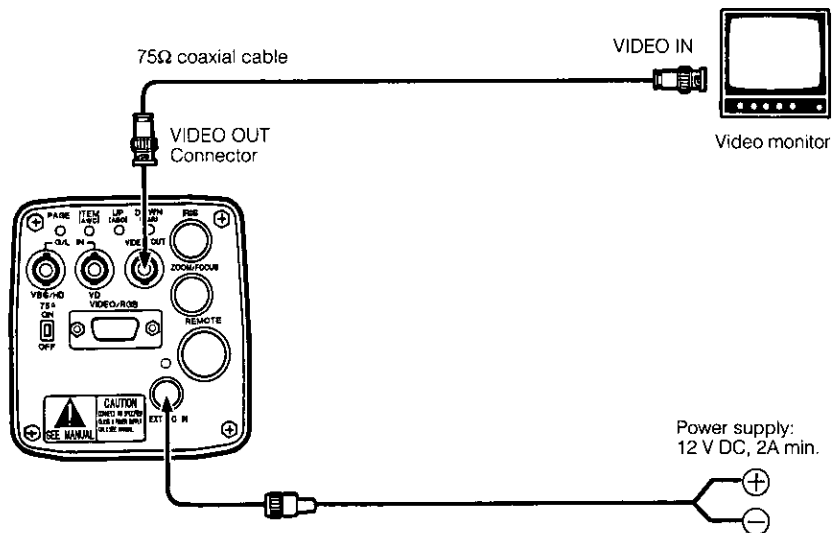

Cautions

1. Connect this to a 12V DC class 2 power supply only.
2. To prevent fire or shock hazard, the UL listed wire VW-1, style 1007 should be used as for the cable for 12V DC Input Connector.

■ CONNECTION OF DEVICE WITH AN RGB MONITOR OR AN IMAGE PROCESSOR

Input signals to an RGB monitor or image processor must be supplied from the VIDEO/RGB connector through the optional D-Sub/BNC cable WV-CA9T5 or D-Sub/D-Sub cable WV-CA9T9.

WV-CA9T5 Cable Information

Pin No.	Wire's Color	Output Signal
3	Red	R/PR/C
4	Green	G/Y/Y
5	Blue	B/PB
6	White	Y/COMP
7	Black	SYNC

Cautions

1. Connect this to a 12V DC class 2 power supply only.
2. To prevent fire or shock hazard, the UL listed wire VW-1, style 1007 should be used as for the cable for 12V DC Input Connector.

NOTES:

- Output signals at the VIDEO/RGB connector can be selected from the INITIAL SET menu displayed on the monitor screen.
- SYNC level can be selected from the INITIAL SET menu displayed on the monitor screen.
- Set the VD RESET ON/OFF switch on the sync board to OFF position.

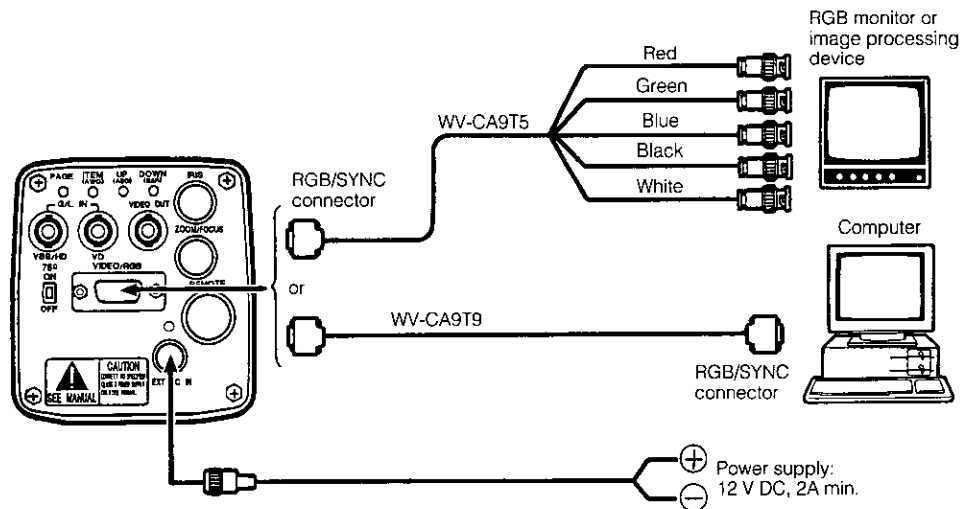

■ CONNECTION OF A REMOTE CONTROLLER (RCU AND A STUDIO CABLE)

Connection to the RCU (WV-RC700A) is made through the optional conversion cable WV-CA26T20 and a studio cable.

1. Turn RCU power off before connecting cables.
2. Set the cable selection switch of the RCU to MULTI.
3. Connect the 20 pin connector of the conversion cable to the REMOTE Connector of the camera. The conversion cable and the studio cable must be connected with the connector supplied as a standard accessory with the conversion cable.

4. Turn RCU power on and the power indicator lamp will light. The camera can now be remote controlled by the RCU.

NOTES:

- Maximum extension length: 300 meters (Studio cables must be connected with joint adaptor WV-CA26T26.)
- Use only the specified cables.
- Set the VD RESET ON/OFF switch on the sync board to OFF position.

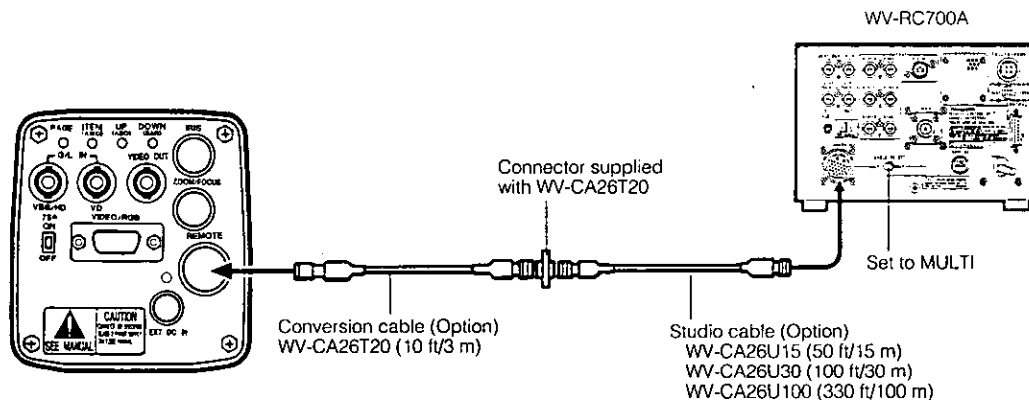

■ CONNECTION OF A REMOTE CONTROL BOX (RCB)

The RCB (WV-CB700A) and the camera must be connected with the optional conversion cable WV-CA20T10.

1. Turn RCB power off before connecting cables.
2. Connect the 20 pin connector of the conversion cable to REMOTE connector of the camera. The 10-pin connector must be connected to the RCB accessory cable or an optional RCB cable.

3. Turn RCB power on and the camera can be remote controlled by the RCB.

NOTES:

- The monitor output signals of the RCB attenuate and deteriorate with cable length. It is recommended that the signals from the monitor output be used for monitoring purpose only.
- No gen-lock signal is available from the RCB.
- Set the VD RESET ON/OFF switch on the sync board to OFF position.

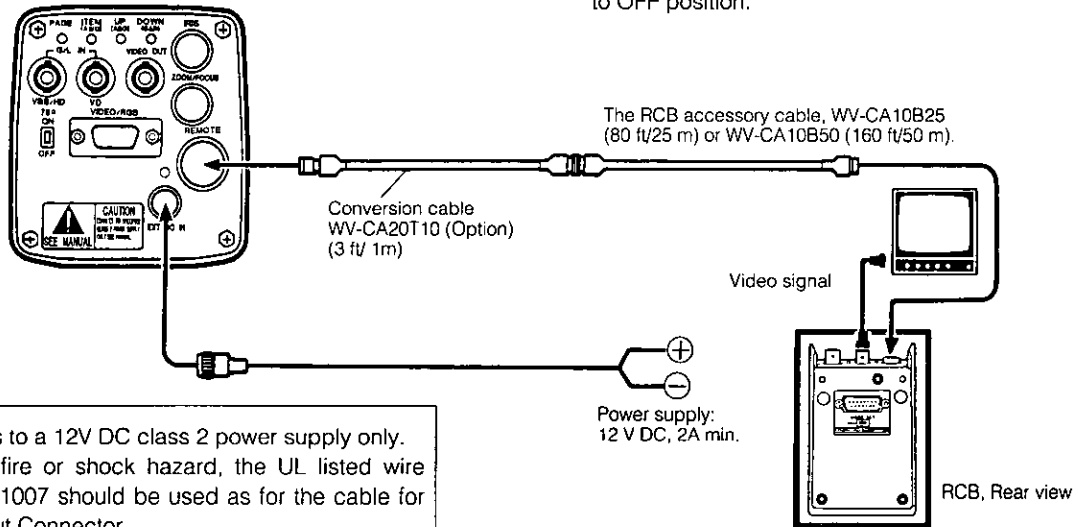

Cautions

1. Connect this to a 12V DC class 2 power supply only.
2. To prevent fire or shock hazard, the UL listed wire WV-1, style 1007 should be used as for the cable for 12V DC Input Connector.

How to assemble the power cable:

The power cable is to be assembled with the connector provided with the camera.

<Connector pin layout>

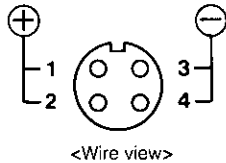

1. Prepare the wire.

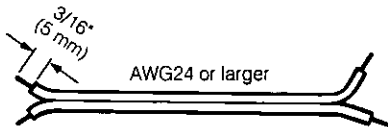

2. Fix with a screw if necessary.
Put the casing and the rubber bushing on after soldering wires to the connector.

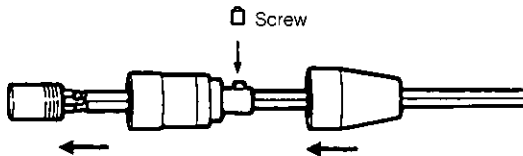

Caution :

To prevent fire or shock hazard, the UL listed wire VW-1, style 1007 should be used as for the cable for 12V DC Input Connector.

ADJUSTMENT

Color temperature and adjustment of white balance

When carbon is burnt, it develops various colors of light depending on the temperature. Natural light can be specified by color temperature referring to the color developed when carbon is burnt.

The light of 3,200K (K=Kelvin, -273C equals to absolute zero temperature 0K) represents the same value (color) as what develops when carbon is burnt at 3,200K (2,927C). The relationship between the color temperature of the light source and weather condition is indicated in the right figure. Let's study the difference of shooting an indoor object from shooting one outdoors. Studio are usually lighted with incandescent lamps and the color temperature of a white object in a studio is around 3,000K. The color temperature of a white object outdoors is around 6,500K. The former may look a little yellowish while the latter appears somewhat bluish when they are shot by a camera. However, human eyes do not recognize the color difference between these objects even under different ambient lighting conditions because of their adaptability to light. The video camera reproduces color differences with high fidelity and the color of an object somewhat different from what appears to the human eyes.

Therefore, there is a need to adjust the white balance in order to correct their differences of color temperature.

NOTE: Color temperature outdoors may vary depending on weather conditions.

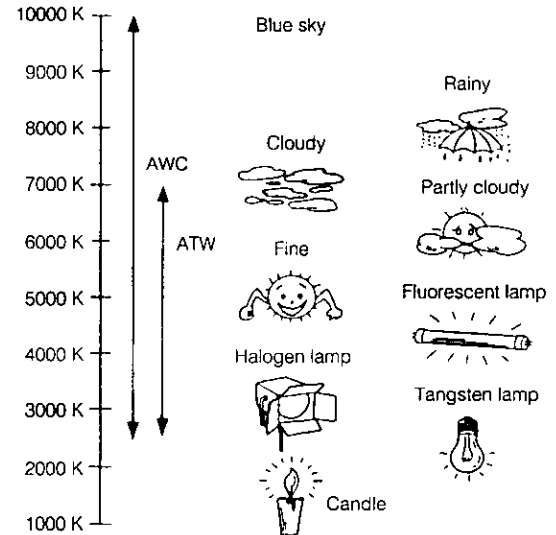

■ AUTOMATIC WHITE BALANCE CONTROL (AWC)

There are two white balance memories, "AWC A" or "AWC B" for two different light sources color temperatures, with the white balance setting. Then, when the two different light sources are encountered, you may properly operate the camera by simply change the white balance mode to either AWC A (A CH) or AWC B (B CH). There is no need to readjust the camera to the ambient conditions.

* The preset conditions will be renewed whenever you input new conditions.

1. Turn the white balance selection switch to either "AWC A" or "AWC B" of RCU or select the white balance mode either A CH or B CH by SETUP menu.
2. Aim the camera at a white object (a white wall or a white handkerchief) and zoom in to enlarge the image as much as possible.

[ADJUSTMENT by CAMERA]

3. In normal shooting mode:
Press the AWC (Item) switch for over 1 second.
In SETUP menu mode:
Select WHITE BAL and press the page switch for over 1 second.
In either case white balance is automatically set in 2 seconds.

[ADJUSTMENT WITH THE RCU (RCB)]

4. When the auto white/auto black set switch is turned to AWC, the white balance will be automatically set regardless of camera operation mode. While the system is being set, auto warning indicator (LED) blinks and it goes out when the white balance setting is completed. If the lamp remains lit, setting must be tried again.
5. If the painting mode is ON in the page No.1 of the INITIAL SET menu, white balance fine adjustment can be performed with the red gain/blue gain adjustment control.

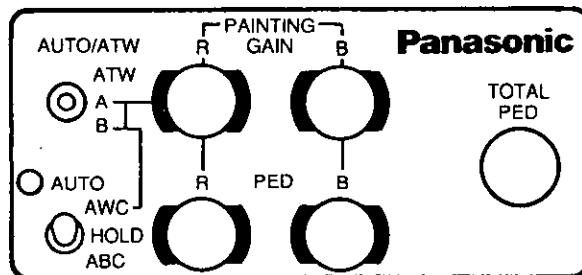

NOTES:

- For white balance setting aim the camera at a white object and try to position it in the center of the monitor screen. The object must appear in over 10% of the total monitor screen area. Try to avoid any overly bright object in the scene.
- White balance may not be correctly set if the lighting of the object is not strong enough.

The white object must occupy over 10% of the monitor screen area.

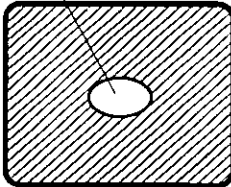

- Since the camera has a built-in battery for memory, the set white balance will be kept in the memory even if power is turned off. Therefore, it is not necessary to reset the white balance if the color temperature of those objects remains unchanged. However, it must be reset if the color temperature changes such as when you move from indoors to outside or vice versa.
- When the camera is used without an RCU or RCB red/blue adjustment of painting setting will be automatically reset to its center after setting the white balance.

■ AUTOMATIC TRACKING WHITE BALANCE SETTING (ATW)

White balance will be automatically set to continuously match the changes of light source and color temperature while the white balance setting is set to ATW in the SETUP menu.

Note: White balance may not be accurately set if there is no white object in the scene being shot.

■ MANUAL WHITE BALANCE SETTING

1. Set the white balance setting to MANU in the SETUP menu.
2. Aim the camera at a large white object.
3. Adjust the red gain/blue gain control in the page No.1 of INITIAL SET menu until the carrier wave of the white portion of the video signal is at the minimum width or the white object in the monitor screen appears pure white. (Use an oscilloscope or a waveform monitor for precise adjustment.)

Note: It cannot be manually adjusted if the camera is controlled by RCU or RCB.

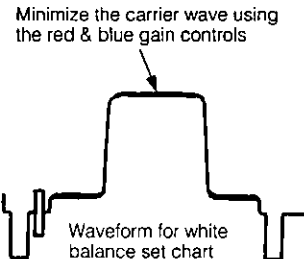

■ RESET TO 3200K OR 5600K WHITE BALANCE

When the white balance setting is set to either "P SET 3.2K" or "P SET 5.6K" the white balance will be automatically set to the color temperature 3,200K or 5,600K respectively.

■ BLACK BALANCE ADJUSTMENT

[ADJUSTMENT by CAMERA]

Press the ABC (UP) Switch for over 1 second and the black balances for 0dB, 9dB and 18dB will be automatically set in 5 seconds.

If the painting switch is ON in the page No.1 of INITIAL SET menu, black balance fine adjustment can be performed with the red gain/blue gain control.

[ADJUSTMENT WITH RCU OR RCB]

Set the auto white/auto black set switch to ABC and the black balance will be automatically set regardless of camera mode. While the system is being set, the auto warning indicator (LED) blinks and it goes out when the black balance setting is completed. If the lamp remains lit, ABC should be tried again.

■ TOTAL PEDESTAL LEVEL ADJUSTMENT

(Use an oscilloscope or a waveform monitor for this adjustment.)

[ADJUSTMENT by CAMERA]

1. Select the page No.1 of the INITIAL SET menu on the monitor screen.
2. Select "T PED" with the item switch.

3. Set the pedestal level to 7.5IRE (0.050V) with the Up switch and the Down switch.

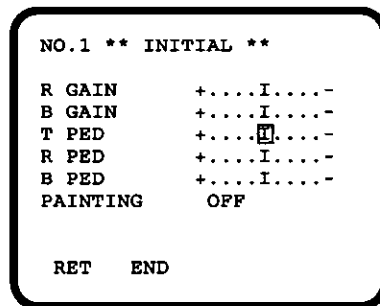

[ADJUSTMENT WITH RCU (RCB)]

Adjust the total pedestal level to 7.5IRE with the total pedestal adjustment.

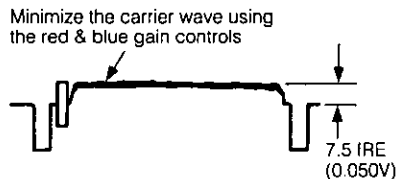

• Automatic iris adjustment when a lens is changed

Turn power on while pressing the item switch. The lens iris is automatically opened and closed for automatic iris adjustment. It will be completed in around 30 seconds.

■ GEN-LOCK ADJUSTMENT

Phase adjustments must be performed with the camera or the RCU (RCB) when external synchronizing signals are supplied to the system in cases where multiple cameras are used or peripheral devices are connected.

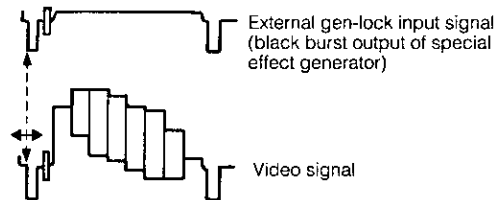
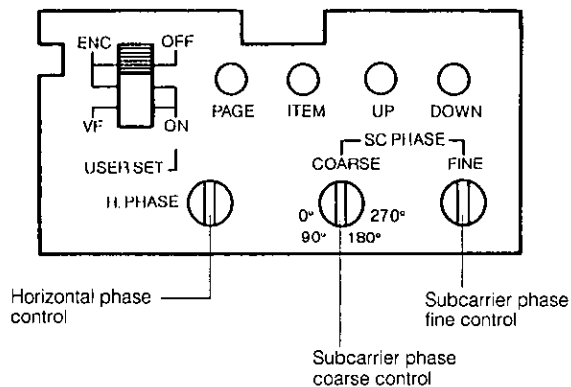

[ADJUSTMENT by CAMERA]

1. Press the BAR (DOWN) switch for over 1 second to display the color bar.
2. Select page No.4 of INITIAL SET menu.
3. Select "H PHASE" with the item switch.
4. Adjust the horizontal phase with the Up switch and Down switch.

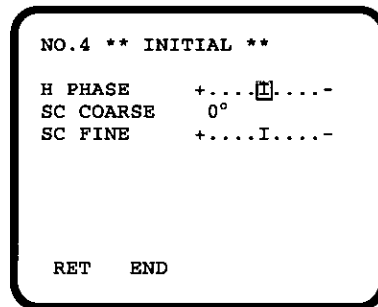

■ HORIZONTAL PHASE CONTROL

Observe the waveform of the external synchronizing input signal (black burst signal) and video output signal on a two-channel oscilloscope. Then match the horizontal phase of both signals by adjusting them with the cameras or RCU's horizontal phase control.

[ADJUSTMENT WITH RCU (RCB)]

Use the horizontal phase control located in the pocket of RCU (RCB).

■ COLOR PHASE ADJUSTMENT

Supply the output signal (split color bar) from the color special effect generator to a color monitor or vectorscope. Adjust the color phase of the camera with either the camera controls or the RCU (RCB) control.

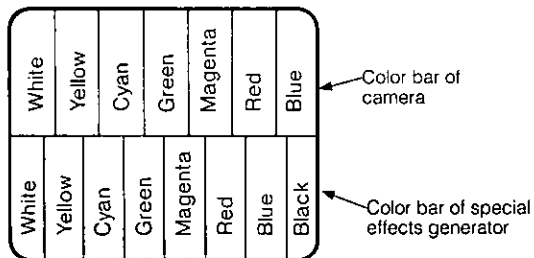

[ADJUSTMENT by CAMERA]

1. Press the BAR (DOWN) switch for over 1 second for the color bar mode.
2. Select page No.4 of INITIAL SET menu.
3. Select "SC COARSE" with the item switch. Make coarse adjustment with the Up switch and the Down switch.
4. Select "SC FINE" with the item switch. Perform fine adjustment with the Up switch and the Down switch.

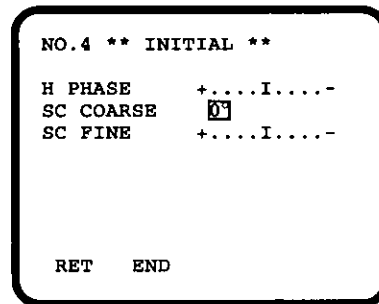

[ADJUSTMENT WITH RCU (RCB)]

Use the subcarrier phase coarse adjustment control and subcarrier phase fine control located in the pocket.

- * It is recommended that a vectorscope be used for maximum accuracy in color phase adjustment.

MENU ITEM SETTING

SETUP Item Setting

■ Setup Memory

The GP-UR612 has a SETUP menu memory, which stores data on the states of the individual functions of the camera preset before shipment from the factory.

Camera operating conditions can be set using the setup function.

The camera has a memory for each scene file.

■ Setup State

Camera alone: Press the page switch for 2 seconds or more.

Camera with RCU (RCB): Set the user set switch to ON.

When the camera has been placed in the setup state, the SETUP menu is displayed on the monitor.

Setup operations can be performed at the camera head or RCU (RCB).

* Composite signals are output from the VIDEO output terminal regardless of the position (ENC/VF) of the user set switch on the RCU (RCB).

* When the camera is used with an RCU (RCB), those items enclosed in parentheses can be adjusted with the switches and controls on the RCU (RCB).

The word END is displayed only when the camera is used alone.

■ Setup Data Screen

<Camera Alone>

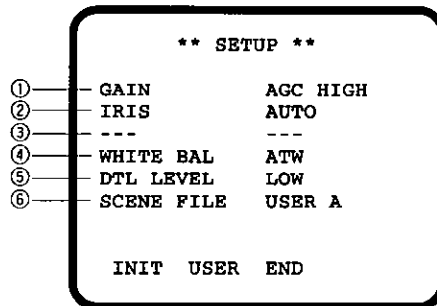

<Camera with RCU (RCB)>

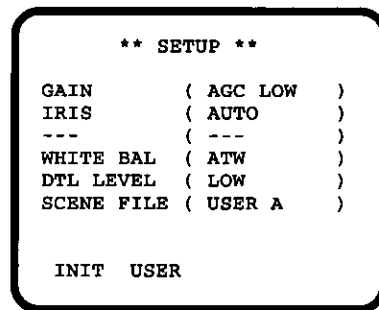

① **Gain Up Control Setting [GAIN: AGC LOW, AGC HIGH, 0DB, 9DB, 18DB]**

When the mode is set to AGC LOW or AGC HIGH, the AGC with a maximum gain increase of about 9 dB/18 dB operates to control gain up and automatically regulate the amount of light.

Normally, the mode should be set to 0DB. If a sufficient video output is not obtained in shooting a dark object even when the iris is fully opened, set the mode to the 9DB or 18DB position.

AGC convergence level, photometric method, and detecting ratio can be set by INITIAL SET menu.

Note:

In using the AGC, it may not function when the iris switch is in the manual position on the lens with auto iris ON in the SETUP menu.

② **Iris Control Setting [IRIS: MANU, AUTO]**

Auto iris convergence level, photometric method, and detecting ratio can be set by INITIAL SET menu.

Note:

When the iris control is set to AUTO in the SETUP menu, set the iris switch on the lens to the A (auto) position. If the iris is set to MANU in the SETUP menu, set the iris switch to the M (manual) position on the lens.

③ **No function**

④ **White Balance Setting [WHITE BAL: ATW, A CH, B CH, MANU, P SET 3.2K, P SET 5.6K]**

When the mode is set to ATW, white balance is automatically adjusted at all times.

When the mode is set to A CH or B CH, with menu OFF, white balance is automatically adjusted with the AWC switch on the back of the camera. Color temperature conditions of two scenes can be stored in the A CH/B CH memories. When the painting mode is ON, fine color adjustment can be made by red/blue gain setting of INITIAL SET menu after AWC.

When the mode is set to MANU, white balance can be adjusted by red/blue gain setting of INITIAL SET menu.

When the mode is set to P SET 3.2K, white balance is adjusted to 3200K illumination.

When the mode is set to P SET 5.6K, white balance is adjusted to 5600K illumination.

Note:

When the camera is used with an RCU (RCB), the switch cannot be set to MANU, P SET 3.2K, or P SET 5.6K.

⑤ **Detail Level Setting [DTL LEVEL: OFF, LOW, HIGH]**

Use this mode to select any of three detail levels as desired: HIGH, LOW, OFF.

Low or high level ranges can be set by using a USER SET menu.

⑥ Scene File Selection Setting [SCENE FILE: 1, 2, 3, USER A, USER B]

Select the scene file.

USER A/B -- User set

SCENE 1:

SCENE 2:

SCENE 3:

- * USER A and B have a memory for each operation mode (2 in total).

■ How to Read Screens

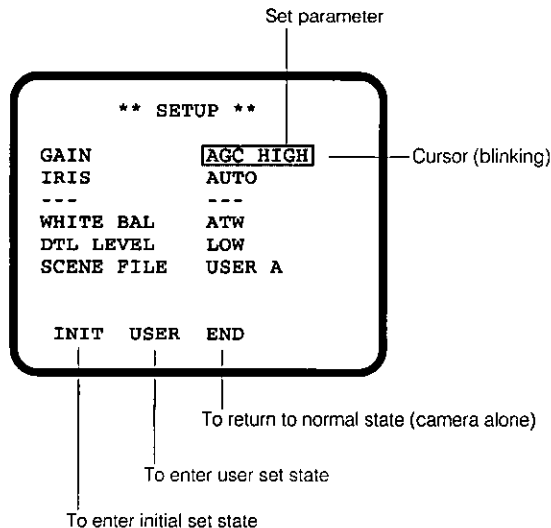

■ How to Set

- (1) The cursor (blinking) moves each time the item switch is pressed. The item indicated by the cursor can be reset or its command can be executed.
- (2) Use the Up and Down switches to change settings.
- (3) When the page switch is pressed after moving the cursor to INIT, the INITIAL SET menu will be displayed.
- (4) When the page switch is pressed after moving the cursor to USER, the camera is ready for user setting.
- (5) To terminate camera setup, move the cursor to END, and press the page switch.

If the camera is used with an RCU (RCB), set the user set switch to OFF.

The camera will then operate according to the settings.

INITIAL SET MENU SETTING

■ Initial Set Memory

The GP-UR612 has an initial set memory, which stores data on the states of the individual functions of the camera preset before shipment from the factory.

Camera operating conditions can be set using the initial set function.

The camera has a memory for each scene file.

■ Initial Set State

- (1) Display the SETUP menu by pressing the page button.
- (2) Move the cursor to INIT and press the page switch.
The camera is initialized and the INITIAL SET menu is displayed on the monitor. Setup operation can be performed at the camera head or RCU (RCB).

■ Initial Set Screen

<Camera Alone>

NO.1 ** INITIAL **		
⑦	R GAIN	+... <u>I</u> ...-
⑧	B GAIN	+...I...-
⑨	T PED	+...I...-
⑩	R PED	+...I...-
⑪	B PED	+...I...-
⑫	PAINTING	OFF
RET		END

NO.2 ** INITIAL **		
AGC AUTO IRIS		
⑬	LEVEL	+... <u>I</u> ...-
⑭	AREA	ALL
⑮	PEAK/AVG	P...I...A
⑯	AUTO IRIS	ADJ OFF
RET		END

On page No. 2 , the light adjusting function that is now ON is displayed on the second line from the top.

- * When the camera is used with an RCU (RCB), those items enclosed in parentheses can be adjusted with the switches and controls on the RCU (RCB).
The word END is displayed only when the camera is used alone.

<Camera with RCU (RCB)>

NO.1 ** INITIAL **		
	R GAIN	(+... <u>I</u> ...-)
	B GAIN	(+...I...-)
	T PED	(+...I...-)
	R PED	(+...I...-)
	B PED	(+...I...-)
	PAINTING	OFF
RET		

NO.2 ** INITIAL **		
AGC AUTO IRIS		
	LEVEL	(+... <u>I</u> ...-)
	AREA	ALL
	PEAK/AVG	P...I...A
	AUTO IRIS	ADJ OFF
RET		

<Camera Alone>

NO.3 ** INITIAL **

17	---	---
18	FLD/FRM	FIELD
19	GAMMA	ON
20	2D LPF	OFF
21	COLOR BAR	1

RET END

NO.4 ** INITIAL **

22	H PHASE	+.... <input type="checkbox"/>-
23	SC COARSE	0°
24	SC FINE	+....I....-

RET END

NO.5 ** INITIAL **

25	OUTPUT SEL1	<input type="checkbox"/> R/G/B
26	OUTPUT SEL2	Y/C
27	SYNC SEL	0.3V
28	CAMERA ID	OFF
29	TIME DATE	OFF

RET END

<RCU (RCB)>

NO.3 ** INITIAL **

---	---
FLD/FRM	FIELD
GAMMA	ON
2D LPF	OFF
COLOR BAR	1

RET

NO.4 ** INITIAL **

H PHASE	(+.... <input type="checkbox"/>-)
SC COARSE	(0°)
SC FINE	(+....I....-)

RET

NO.5 ** INITIAL **

OUTPUT SEL1	<input type="checkbox"/> R/G/B
OUTPUT SEL2	Y/C
SYNC SEL	0.3V
CAMERA ID	OFF
TIME DATE	OFF

RET

⑦ **Red gain adjustment [R GAIN]**

⑧ **Blue gain adjustment [B GAIN]**

When the white balance setting is set to MANU in the SETUP menu, white balance can be adjusted by red/blue gain control. Fine adjustment of white balance can also be made after AWC by red/blue gain control when the white balance setting is set to A CH or B CH in the SETUP menu and the painting mode is ON in the page No 5 of the INITIAL SET menu.

* A memory is provided for each of MANU, A CH, and B CH.

If AWC is executed when the camera is used alone, the memories for A CH and B CH return to the center.

⑨ **Total Pedestal Adjustment [T PED]**

The pedestal of the luminance (Y) signal can be set. It is used to match the pedestals of two or more cameras.

⑩ **Red Pedestal Adjustment [R PED]**

⑪ **Blue Pedestal Adjustment [B PED]**

Fine adjustment of black balance can also be made after ABC by red/blue pedestal adjustment when the painting mode is ON in the INITIAL SET menu.

* If ABC is executed when the camera is used alone, the value of R/B PED returns to the center.

⑫ **Painting Setting [PAINTING: ON/OFF]**

If white balance is set to either A CH or B CH in the SETUP menu when the painting switch is ON, fine adjustment of white balance can be made after AWC by red/blue gain control.

Fine adjustment of black balance after ABC can also be made by red/blue pedestal adjustment.

⑬ **AUTO IRIS/AGC Level Adjustment [LEVEL]**

Convergence level of AUTO IRIS/AGC can be adjusted.

⑭ **Photometric Measurement Method Setting**

[AREA: ALL, CENTER, TOP CUT, BOT CUT, R/L CUT]

A photometric measurement method can be selected for AUTO IRIS/AGC.

- . ALL: All the screen area is measured.
- . CENTER: The screen is measured mainly in the center area, about one-third each of the top and bottom and one third each of the right and left parts of the screen are cut out from measurement.
- . TOP CUT: About one-third of the top part of the screen is cut out from measurement.
- . BOT CUT: About one-third of the bottom part of the screen is cut out from measurement.
- . R/L CUT: About one-third each of the right and left parts of the screen is cut out from measurement.

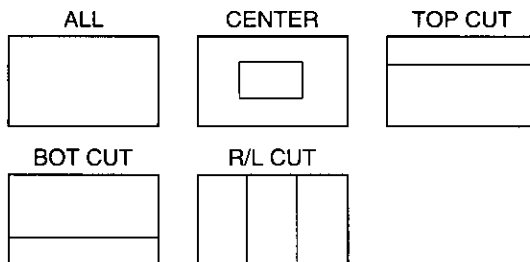

15 Detecting Ratio Adjustment [PEAK/AVG]

The ratio of AUTO IRIS/AGC detected peak to average can be adjusted in a range of 9 steps.

16 AUTO IRIS Level Fine Adjustment Setting [AUTO IRIS : ADJ ON/ADJ OFF]

When the mode is set to ADJ ON, fine adjustment of ALC/ AGC convergence level can be made with the iris VR control on the RCU (RCB) if the camera is used with an RCU (RCB) and the iris mode is set to AUTO in the SETUP menu.

17 No function

18 CCD Read Out Mode Setting [FLD/FRM: FIELD/ FRAME]

The position FIELD means CCD field storage. The position FRAME means frame storage, in which case vertical resolution increases.

FIELD : Set to this mode when shooting moving object.

FRAME : Set to this mode when shooting still object.

* It is recommended that the mode be normally kept at FIELD because, if the mode is set to FRAME, residual image will increase.

19 Gamma Correction ON/OFF Setting [GAMMA: ON, OFF]

Gamma correction ON/OFF can be set.

* Gamma correction level can be set using a user set menu.

20 2-Dimensional Lowpass Filter ON OFF Setting [2D LPF: ON, OFF]

2D lowpass filter ON/OFF can be set to reduce cross colors.

21 Color Bar Setting (COLOR BAR: 1, 2, 3, 4)

Color bars can be selected.

- 1: SMPTE color bar with 0.0% setup
- 2: SMPTE color bar with 7.5% setup
- 3: Full color bar with 0.0% setup
- 4: Full color bar with 7.5% setup

22 Horizontal Phase Adjustment [H PHASE]

Horizontal phase can be adjusted when a genlock signal is supplied.

23 Sub Carrier Phase Coarse Adjustment [SC COARSE: 0°, 90°, 180°, 270°]

Coarse adjustment of sub carrier phase can be made when a genlock signal is supplied.

24 Sub Carrier Phase Fine Adjustment [SC FINE]

Fine adjustment of sub carrier phase can be made when a genlock signal is supplied.

25 Output Signal Setting 1 [OUTPUT SEL1: R/G/B, Y/C, Y/PR/PB]

Output signals from the VIDEO/RGB connector or REMOTE connector on the back of the camera can be selected.

26 Output Signal Setting 2

[OUTPUT SEL2: Y/C, COMPOSITE]

Output signals from the VIDEO/RGB connector on the back of the camera can be selected.

27 Synchronizing Signal Output Level Setting

[SYNC SEL: 0.3 V/4.0 V]

The synchronizing signal output level from the VIDEO/RGB connector on the back of the camera can be selected.

28 Camera ID on/off Setting [CAMERA ID: ON/OFF]

Used for Camera ID setting and Camera ID display on the monitor.

29 Time Date on/off setting [TIME DATE: ON/OFF]

Used for Time Date setting and TIME/DATE display on the monitor.

How to Read Screens

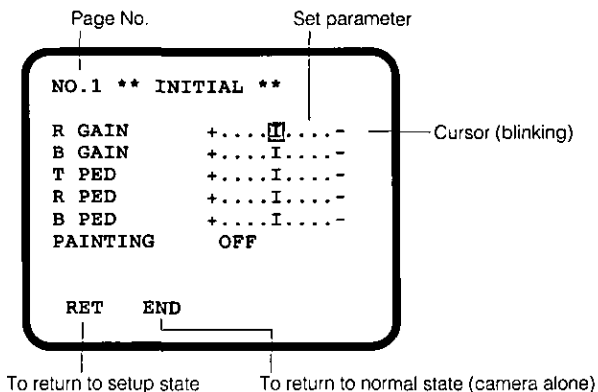

How to Set

- (1) The screen changes from one page to another each time the page switch is pressed.
- (2) The cursor (blinking) moves each time the item switch is pressed. The item indicated by the cursor can be reset or its command can be executed.
- (3) Use the Up and Down switches to change settings.
- (4) To return to the SETUP menu state, move the cursor to RET and press the page switch.
- (5) To return to the normal state, take the following steps.
If the camera is used alone, move the cursor to END, and press the page switch.
If the camera is used with an RCU (RCB), set the user set switch to OFF.
The camera will then operate according to the settings.

■ SETUP/INITIAL Set Memory Reset

The GP-UR612 has a reset function, which restores the original settings if the wrong data is set in either the SETUP or INITIAL SET menu.

- (1) Display the SETUP menu by pressing the page (PAGE) switch for about 2 seconds.
- (2) Move the cursor to SCENE FILE by item (ITEM/AWC) switch, then select the scene file No. 1, 2 or 3 for reset.
- (3) Move the cursor to END and press the page (PAGE) switch to return to normal state.
- (4) Switch camera power off, and while pressing the page (PAGE) switch, power on the camera till the screen shown at right on the top appears.
- (5) If YES is selected by pressing the Up switch within about 10 seconds after this screen on the top is shown, the setup/initial set memory is reset, a message appears as shown at right on the center, and the operation returns to normal state.
- (6) Unless NO is selected by pressing the Down switch within about 10 seconds after the shown in Step (4) above appears, or unless the Up switch or the Down switch is pressed after more than 10 seconds or more after the screen shown in Step (4) appears, the reset operation is suspended as indicated by the screen at right on the bottom and the operation returns to normal state.

RESET SETUP/INITIAL?

YES : UP SW
NO : DOWN SW

NOW RESET
SETUP/INITIAL MEMORY

NON RESET

USER SETUP MENU SETTING

■ Scene File Memory

The GP-UR612 has five scene file memories, of which three are preset before shipment from the factory. When the scene file menu mode is set to [1], [2], or [3], the camera operates under the preset conditions.

The remaining two, USER A and USER B, can be set as desired.

■ User Set Screens

<Camera Alone>

NO.1	USER A	* 0DB
(.35-.55)	CURR	NEW
*GAMMA (NOR)	.45	[.45]

KNEE POINT	98	98%
WHITE CLIP	110	110%
*H.DTL LEVEL H	31	31
*V.DTL LEVEL H	31	31
*H.DTL LEVEL L	15	15
*V.DTL LEVEL L	15	15
RET	END	

■ User Setting

- (1) Display the SETUP menu.
- (2) Select the USER A or USER B of scene file from the SETUP menu.
- (3) Move the cursor to USER, and press the page switch. The camera is now in the user set state, and the USER set screen appears on the monitor. User set operation can be performed at the camera head or RCU (RCB).

<Camera with RCU (RCB)>

NO.1	USER A	* 0DB
(.35-.55)	CURR	NEW
*GAMMA (NOR)	.45	[.45]

KNEE POINT	98	98%
WHITE CLIP	110	110%
*H.DTL LEVEL H	31	31
*V.DTL LEVEL H	31	31
*H.DTL LEVEL L	15	15
*V.DTL LEVEL L	15	15
RET		

* Data of those items marked "*" can be stored in the memory at each of the gain levels (0, 9, 18 dB).

<Camera Alone>

	NO.2	USER A	* ODB	
	(2- 5)		CURR NEW	
34	*DTL BAND	5	5	
35	*NOISE SUP	1	1	
36	*LEVEL DEP	0	0%	
37	*CHROMA DTL	0	0	
38	DARK DTL	0	0	
	RET	END		

<Camera with RCU (RCB)>

	NO.2	USER A	* ODB	
	(2- 5)		CURR NEW	
	*DTL BAND	5	5	
	*NOISE SUP	1	1	
	*LEVEL DEP	0	0%	
	*CHROMA DTL	0	0	
	DARK DTL	0	0	
	RET			

	NO.3	USER A	* ODB	
	(-25- 25)		CURR NEW	
39	MATRIX (R-G)	0	0%	
	(R-B)	0	0%	
	(G-R)	0	0%	
	(G-B)	0	0%	
	(B-R)	0	0%	
	(B-G)	0	0%	
40	FLARE RED	0	0	
	GREEN	0	0	
	BLUE	0	0	
	RET	END		

	NO.3	USER A	* ODB	
	(-25- 25)		CURR NEW	
	MATRIX (R-G)	0	0%	
	(R-B)	0	0%	
	(G-R)	0	0%	
	(G-B)	0	0%	
	(B-R)	0	0%	
	(B-G)	0	0%	
	FLARE RED	0	0	
	GREEN	0	0	
	BLUE	0	0	
	RET			

30 Gamma Compensation Level Setting

[GAMMA (NOR): .35 to .55]

[← :→]

Gamma correction level can be set.

31 Knee Compensation Level Setting

[KNEE POINT: 88% to 98%]

The level of video signals subject to knee correction (knee point) can be set.

32 White Clip Level Setting

[WHITE CLIP: 95% to 110%]

The peak level of video signals to be white-clipped can be set.

33 Horizontal Detail High Level Setting: LEVEL HIGH

[H. DTL LEVEL H]

Vertical Detail High Level Setting: LEVEL HIGH

[V. DTL LEVEL H]

Horizontal Detail Low Level Setting: LEVEL LOW

[H. DTL LEVEL L]

Vertical Detail Low Level Setting: LEVEL LOW

[V. DTL LEVEL L]

Detail level, high or low, horizontal or vertical, can be set.

The range of detail setting is 0 to 63, provided that HIGH must be set at least 1 level higher than LOW.

34 Detail Band Level Setting

[DTL BAND: 1 to 5]

The contour correction band at high or low frequencies can be set.

The larger the number, the finer the detail.

35 Noise Suppress Compensation Level Setting

[NOISE SUP: 0 to 10]

Screen noise can be reduced when high or low detail level is set. If noise suppress correction level is set too high, however, fine detail objects will appear less distinct.

36 Level Dependent Compensation Level Setting

[LEVEL DEP: 0% to 25%]

Screen noise in the dark parts of an objects if processed by the detail signal can be reduced. If level dependent correction level is set too high, however, fine detail objects like hair, for example, may appear less distinct.

37 Chroma Aperture Compensation Level Setting

[CHROMA DTL: 0 to 15]

The contours of the highly color saturated part of an object can be emphasized.

38 Dark Detail Level Setting

[DARK DTL: 0 to 5]

The contours of the dark part of an object can be emphasized.

Note:

Dark detail setting is invalid unless level dependent correction level [LEVEL DEP] is set to 0.

39 Matrix Compensation Level Setting

[MATRIX (R-G): -25% to 25%]

[MATRIX (R-B): -25% to 25%]

[MATRIX (G-R): -25% to 25%]

[MATRIX (G-B): -25% to 25%]

[MATRIX (B-R): -25% to 25%]

[MATRIX (B-G): -25% to 25%]

Matrix compensation level can be adjusted.

- (R-G): To increase or decrease the intermediate color between red and magenta
- (R-B): To increase or decrease the intermediate color between red and yellow
- (G-R): To increase or decrease the intermediate color between green and cyan
- (G-B): To increase or decrease yellowish green
- (B-R): To increase or decrease the intermediate color between blue and cyan
- (B-G): To increase or decrease purple

40 Flare Compensation Level Setting

[FLARE RED: 0 to 100]

[FLARE GREEN: 0 to 100]

[FLARE BLUE: 0 to 100]

Flare correction level can be adjusted.

- Flare correction level has already been adjusted prior to shipment from the factory.

How to Read Screens

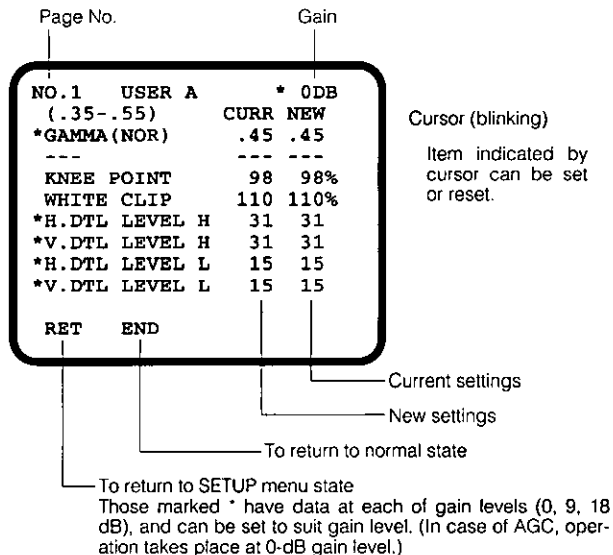

How to Set

- (1) The screen changes from one page to another each time the page switch is pressed.
- (2) The cursor (blinking) moves each time the item switch is pressed. The item indicated by the cursor can be reset or its command can be executed.
- (3) Use the Up and Down switches to change settings.

- (4) To return to the SETUP menu state, move the cursor to RET and press the page switch.
- (5) To change gain up, move the cursor to GAIN in the SETUP menu, and use the Up or Down switch. (This applies in cases where the camera is used alone.)

■ User Set Memory Reset

The GP-UR612 has a reset function, which restores the original settings if wrong data is entered in user A or user B memories.

- (1) Display the SETUP menu by pressing the page (PAGE) switch for about 2 seconds.
- (2) Move the cursor to SCENE FILE by item (ITEM/AWC) switch, then select the scene No. USER A or USER B for reset.
- (3) Move the cursor to END and press the page (PAGE) switch to return to normal state.
- (4) Switch camera power off, and while pressing the page (PAGE) switch, power on the camera till the screen show at right on the top appears.
(In case of USER B is selected for reset, RESET USER B? appears on the screen.)
- (5) If YES is selected by pressing the Up switch within about 10 seconds after the screen shown in Step (4) appears, the user set memory is reset, a message appears as shown at right on the bottom, and the operation returns to normal state.
(In case of USER B is selected for reset, NOW RESET USER B MEMORY appears on the screen.)

- (6) To return to the normal state, do the following steps.
If the camera is used alone, move the cursor to END, and press the page switch.
If the camera is used with an RCU (RCB), set the user set switch to OFF.
The camera will then operate according to the settings.

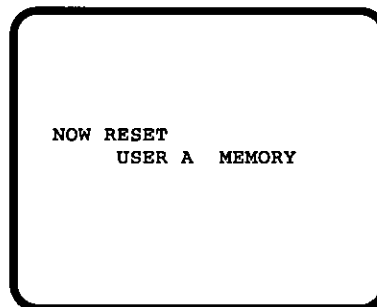
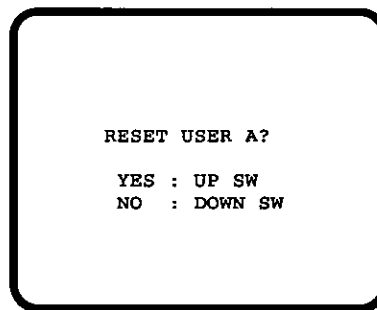

- (6) Unless NO is selected by pressing the Down switch within about 10 seconds after the screen shown in Step (4) above appears, or unless the Up switch or the Down switch is pressed in 10 seconds or more after the screen shown in Step (4) appears, the reset operation is suspended as indicated by the screen at right, and the operation returns to normal state.

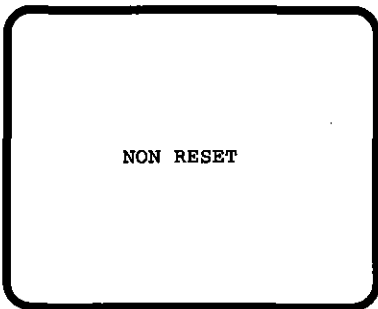

INSTALLATIONS

INSTALLATION OF CAMERA FOR MICROSCOPE APPLICATION

Install the microscope attachment with the bayonet mount on the microscope and then install the camera.

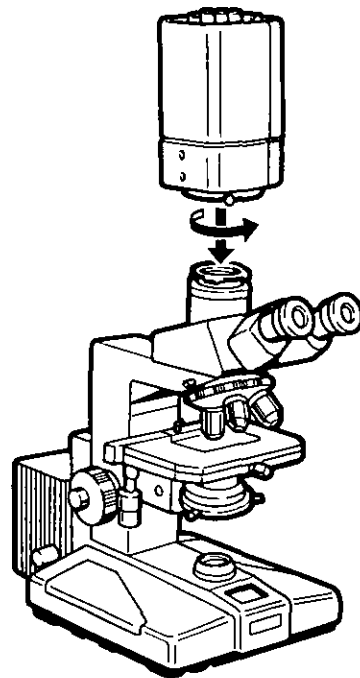

INSTALLATION OF CAMERA WITH MOUNTING BRACKET

The camera can be mounted using the mounting hole on top or the one in the bottom of the camera as shown below.

The mounting hole has a standard 1/4-20" thread designed for pan-head screws, such as those used on tripods.

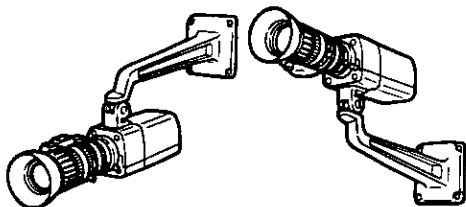

Caution:

If this camera will be mounted on a tripod or mounting bracket, Each must be capable of supporting four times the total weight of the camera.

CAMERA ID SETTING

■ Camera ID

The GP-UR612 has a camera ID function, which enables you to mix the set characters with video output.

The maximum number of characters that can be set to 16.

■ Camera ID Setting

- (1) Select the page No. 5 of the INITIAL SET menu.
- (2) Move the cursor to CAMERA ID, and press the page switch for 2 seconds or more.

The camera is ready for ID setting, and its screen appears on the monitor.

Camera ID can be set at the camera head or RCU (RCB).

■ Camera ID Set Screen Camera Alone

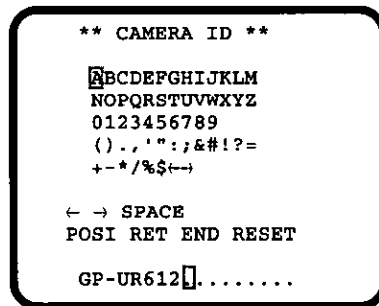

Camera with RCU (RCB)

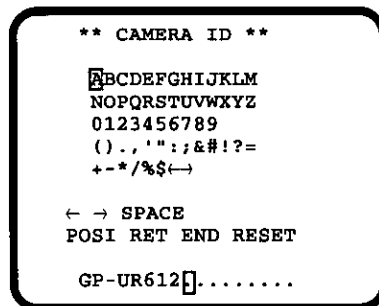

■ How to Read Screens

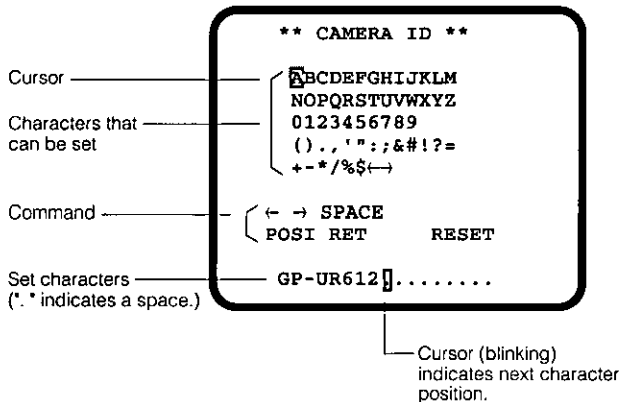

■ Camera ID Setting

- (1) Display the page No. 5 of the INITIAL SET menu.
- (2) Move the cursor to CAMERA ID, and press the page switch for more than 2 seconds to display the camera ID setting mode.

■ How to Set

- (1) Move the cursor (blinking) using the item switch, Up switch, or Down switch, and select characters or a command to set.

Item switch: To move the cursor 1 line down
 Up switch: To move the cursor 1 position left
 Down switch: To move the cursor 1 position right

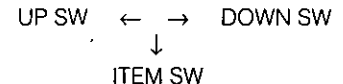

- (2) To enter a character for camera ID, press the page switch when the cursor is on the desired character. The character is set, and is shown on the bottom line of the screen.
- (3) If the page switch is pressed when the cursor is at ←, the cursor moves from the set character to one position left.
- (4) If the page switch is pressed when the cursor is at →, the cursor moves from the set character to one position right.
- (5) If the page switch is pressed when the cursor is at SPACE, a blank is left.
- (6) If the page switch is pressed when the cursor is at POSI, camera ID display position is ready to be set.
- (7) If the page switch is pressed when the cursor is at RESET, all the set characters are erased.
- (8) To return to the INITIAL SETUP menu state, move the cursor to RET and press the page switch.
- (9) To return to the normal state, do the following steps.
 If the camera is used alone, move the cursor to END, and press the page switch.
 If the camera is used with an RCU (RCB), set the user set switch to OFF.

■ Camera ID Display Position

Camera ID display position can be set as desired.

■ Camera ID Display Position Setting

- (1) Set a camera ID.
- (2) Move the cursor to POSI, and press the page switch. Camera ID display position is ready to be set, and its screen appears on the monitor. Camera ID display position can be set at the camera head or RCU (RCB).

Note

Unless a camera ID has been set, camera ID display position will not be ready for setting.

■ Camera ID Position Set Screen

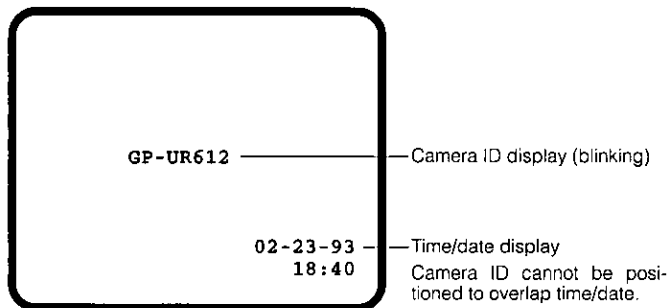

■ How to Set

- (1) Move the set camera ID using the item switch, Up switch, or Down switch.

Item switch: To move the cursor 1 line down with each press

Up switch: To move the cursor 1 position left with each press

Down switch: To move the cursor 1 position right with each press

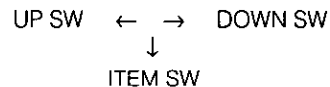

If the item switch is pressed when the cursor is at the bottom line, the cursor moves to the top line.

Even if the Up switch is pressed when the camera ID is at the far left end, its position will not change.

Even if the Down switch is pressed when the camera ID is at the far right end, its position will not change.

If the camera ID is positioned over time/date display using the item switch, it moves 1 line below time/date.

If the camera ID is positioned over time/date display using the Up/Down switch, no change is made in its position.

- (2) To return to the camera ID set-screen, press the page switch.
- (3) When the camera is used alone, it cannot directly return to the normal state.

If the camera is used with an RCU (RCB), set the user

TIME/DATE SETTING

■ Time/Date Setting

The GP-UR612 has a time/date function, which enables you to mix year/month/day/hours/minutes with video output.

■ Time/Date Set Screen

<Camera Alone>

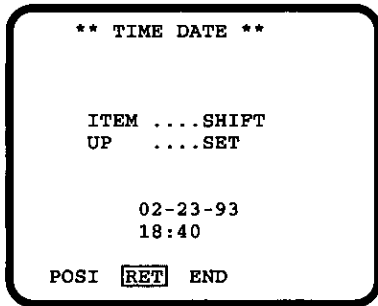

- (1) Display the page No. 5 of the INITIAL SET menu.
- (2) Move the cursor to TIME DATE, and press the page switch for 2 seconds or more.

The camera is ready for time/date setting, and its screen appears on the monitor.

Time/date can be set at the camera head or RCU (RCB).

<Camera with RCU (RCB)>

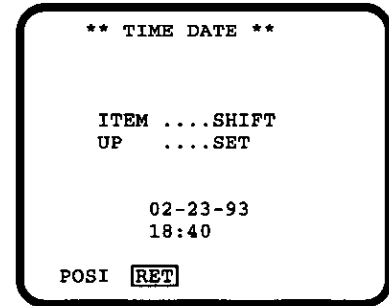

■ How to Set

- (1) Select the date and time positions to change, or a command, using the item switch.
- (2) To change time/date, use the Up switch.
The set value increases each time the Up switch is pressed. Stop pressing it when the desired figure appears.
(If the Up switch is kept depressed, the figure increases rapidly.)
- (3) If the page switch is pressed when the cursor is at POSI, time/date display position is ready to be set.
- (4) To return to the INITIAL SET menu screen, move the cursor to RET, and press the page switch.
- (5) To return to the normal state, do the following steps.
If the camera is used alone, move the cursor to END, and press the page switch.
If the camera is used with an RCU (RCB), set the user set switch to OFF.

■ Time/Date Display Position

Time/date display position can be set as desired.

■ Time/Date Display Position Setting

- (1) Set time/date.
- (2) Move the cursor to POSI, and press the page switch.
Time/date display position is ready to be set, and its screen appears on the monitor.
Time/date display position can be set at the camera head or RCU (RCB).

■ Time/Date Display Position Set Screen

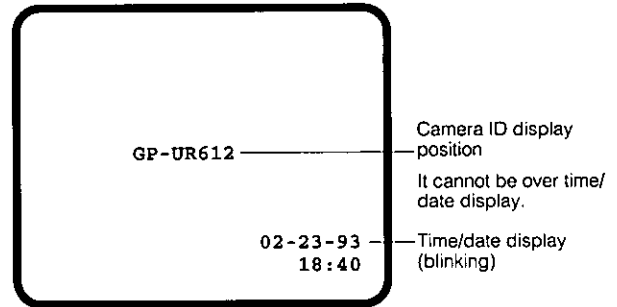

■ How to Set

- (1) Move the set time/date display position using the item switch, Up switch, or Down switch.
Item switch: To move the cursor 1 line down
Up switch: To move the cursor 1 position left
Down switch: To move the cursor 1 position right

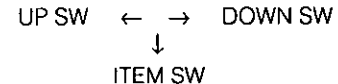

RANGE OF SETUP/INITIAL SET AND THEIR INITIAL VALUES

MENU	ITEM	VALUE
SETUP MENU	GAIN	0dB
	IRIS	MANU
	---	---
	WHITE BAL	Ach
	DTL LEVEL	LOW
INITIAL SET (PAGE 1)	SCENE FILE	SCENE1
	R GAIN	CENTER
	B GAIN	CENTER
	T PED	CENTER
	R PED	CENTER
	B PED	CENTER
	PAINTING	OFF
INITIAL SET (PAGE 2)	LEVEL	CENTER
	AREA	ALL
	PEAK/AVG	CENTER
	AUTO IRIS	ADJ OFF
INITIAL SET (PAGE 3)	---	---
	FLD/FRM	FIELD
	GAMMA	ON
	2D LPF	OFF
	COLOR BAR	2
INITIAL SET (PAGE 4)	H PHASE	CENTER
	SC COARSE	0°
	SC FINE	CENTER
INITIAL SET (PAGE 5)	OUTPUT SEL 1	R/G/B
	OUTPUT SEL 2	Y/C
	SYNC SEL	0.3V
	CAMERA ID	OFF
	TIME DATE	OFF

SCENE FILE /USER AND THEIR INITIAL VALUE

ITEM	SCENE 1			SCENE 2			SCENE 3			USER A			USER B		
	0dB	9dB	18dB	0dB	9dB	18dB	0dB	9dB	18dB	0dB	9dB	18dB	0dB	9dB	18dB
GAMMA (NOR)	0.45	←	0.55	0.45	←	0.55	0.45	←	0.55	0.45	←	0.55	0.45	←	0.55
---	---	←	←	←	←	←	←	←	←	←	←	←	←	←	←
KNEE POINT	88			←			←			←			←		
WHITE CLIP	110			←			←			←			←		
H DTL LEVEL H	31	←	20	31	←	20	31	←	20	31	←	20	31	←	20
V DTL LEVEL H	31	←	20	31	←	20	31	←	20	31	←	20	31	←	20
H DTL LEVEL L	15	←	10	15	←	10	15	←	10	15	←	10	15	←	10
V DTL LEVEL L	15	←	10	15	←	10	15	←	10	15	←	10	15	←	10
DTL BAND	1	←	←	5	←	←	1	←	←	←	←	←	←	←	←
NOISE SUP	0	←	←	←	←	←	←	←	←	←	←	←	←	←	←
LEVEL DEP	0	←	←	←	←	←	←	←	←	←	←	←	←	←	←
CHROMA DTL	15	←	←	←	←	←	0	←	←	15	←	←	←	←	←
DARK DTL	5	/		5	/		0	/		5	/		5	/	
MATRIX (R-G)	0			←			←			←			←		
(R-B)	0			←			←			←			←		
(G-R)	0			←			←			←			←		
(G-B)	0			←			←			←			←		
(B-R)	0			←			←			←			←		
(B-G)	0			←			←			←			←		
FLARE R															
G															
B															
Remarks	Standard			Detail High			FA			Standard			Standard		

Note : The value for FLARE R, G and B are not indicated in this table.
The value is differ from camera by camera.

SPECIFICATIONS

Pickup element	1/2" interline, supersensitive CCD
Pixels	768 (H) x 494 (V) pixels
Scanning	2:1 interlace
System	NTSC
Scanning frequency	15.734 kHz (horizontal), 59.94 Hz (vertical)
Lens mount	1/2" standard bayonet mount
Synchronizing	Internal or external
External sync input	VBS, BB, HD/VD and VD reset
Sensitivity	2000 lux, F8, 3200 K
Minimum illumination	7 lux, F1.4, +18 dB
Signal-to-noise ratio	62 dB (typical)
Horizontal resolution	550 TV lines (center)
Registration	0.05%
Contour correction	Horizontal and vertical
White balance	Auto (2 memories), 3200 K/5600 K, MANU, ATW
Black balance	AUTO
Color bar	SMPTE, full color bar (Setup 0/7.5)
Encoder	Y, R-Y, B-Y
Gain	0 dB, 9 dB, 18 dB, AGC
Gamma correction	ON/OFF switchtable
Storage mode	Field/frame switchable
Iris	AUTO
Video output	Composite: 1 Vp-p (75 Ω) R/B/G: 0.7 Vp-p (75 Ω) Y: 1 Vp-p (75 Ω) C: 0.286 Vp-p (burst level) PR: 0.7 Vp-p (75 Ω) PB: 0.7 Vp-p (75 Ω) Sync: 4 V/0.3 V (75 Ω) switchable

Source voltage	12 V DC
Power consumption	12.0 W
Operating temperature	14°F to +113°F (-10°C to +45°C)
Storage temperature	4°F to +140°F (-20°C to +60°C)
Dimensions	3-3/16" (W) x 3-3/8" (H) x 6-5/8" (D) (81 (W) x 86 (H) x 169 (D) mm)
Weight	2.42 lbs. (1.1 kg)

Weight and dimensions indicated are approximate.
Specifications are subject to change without notice.

STANDARD ACCESSORIES

Body cap	1
4 pin connector for EXT DC IN	1

OPTIONAL ACCESSORIES

Camera Adaptor	WV-PS550	Connection Cable (Dsub-BNC)	
Remote Control Unit (RCU)	WV-RC700A	WV-CA9T5 (9-pin - BNC, approx. 16ft/5m)	
Remote Control Box (RCB)	WV-CB700A	Studio Cable (for WV-RC700A)	
RCU Rack Mount Frame	WV-Q70	WV-CA26U15 (26-pin - 26-pin, approx. 50ft/15m)	
Lens Extension Cable		WV-CA26U30 (26-pin - 26-pin, approx. 100ft/30m)	
WV-CA12T12 (12-pin - 12-pin, approx. 6"/15 cm)		WV-CA26U100 (26-pin - 16-pin, approx. 330ft/100m)	
Conversion Cable (for WV-CB700A)		Joint Connector	WV-CA26T26 (26-pin - 26-pin))
WV-CA20T10 (20-pin - 10-pin, approx. 3ft/1m)		RCB Cable (for WV-CB700A)	
Conversion Cable (for WV-RC700A)		WV-CA10B25 (10-pin - 10-pin, approx. 80ft/25m)	
WV-CA26T20 (26-pin - 20-pin, approx. 10ft/3m)		WV-CA10B50 (10-pin - 10-pin, approx. 160ft/50m)	
Connection Cable (Dsub-Dsub)			
WV-CA9T9 (9-pin - 9-pin, approx. 16ft/5m)			

Panasonic

Broadcast & Television Systems Company

Division of Matsushita Electric Corporation of America

INDUSTRIAL CAMERA DIVISION

Executive Office: One Panasonic Way, 4H-2, Secaucus, New Jersey 07094 (201) 392-6674

MATSUSHITA ELECTRIC OF CANADA LIMITED

5770 Ambler Drive, Mississauga, Ontario, Canada L4W 2T3 (905) 624-5010

PANASONIC SALES COMPANY

DIVISION OF MATSUSHITA ELECTRIC OF PUERTO RICO, INC.

San Gabriel Industrial Park, 65th Infantry, Ave. KM. 9.5 Carolina, Puerto Rico 00630 (809) 750-4300