

Memorex®

PORTABLE CD PLAYER WITH AM/FM STEREO RADIO AND CASSETTE RECORDER

MODEL: MP3823

**BEFORE OPERATING THIS PRODUCT, PLEASE READ THESE
INSTRUCTIONS COMPLETELY.**

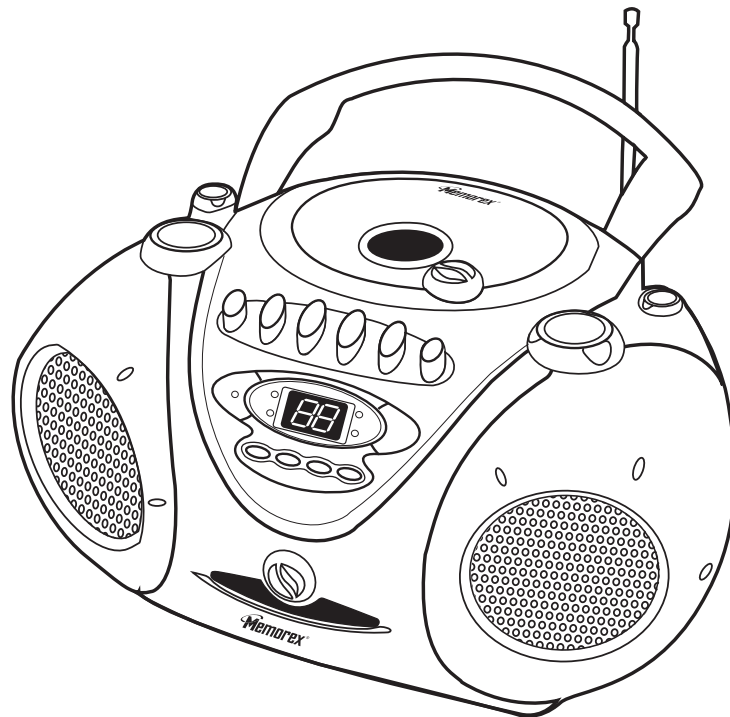

OPERATING INSTRUCTIONS

WARNING

TO PREVENT FIRE OR SHOCK HAZARD, DO NOT USE THIS PLUG WITH AN EXTENSION CORD, RECEPTACLE OR OTHER OUTLET UNLESS THE BLADES CAN BE FULLY INSERTED TO PREVENT BLADE EXPOSURE. TO PREVENT FIRE OR SHOCK HAZARD, DO NOT EXPOSE THIS APPLIANCE TO RAIN OR MOISTURE.



The lightning flash with arrowhead symbol, within an equilateral triangle is intended to alert the user to the presence of uninsulated 'dangerous voltage' within the product's enclosure that may be of sufficient magnitude to constitute a risk of electric shock to persons.

CAUTION

**RISK OF ELECTRIC SHOCK
DO NOT OPEN**

CAUTION: TO REDUCE THE RISK OF ELECTRIC SHOCK DO NOT REMOVE COVER (OR BACK), NO USER SERVICEABLE PARTS INSIDE REFER SERVICING TO QUALIFIED SERVICE PERSONNEL.



The exclamation point within an equilateral triangle is intended to alert the user to the presence of important operating and maintenance (servicing) instructions in the literature accompanying the appliance.

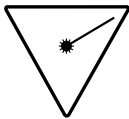

DANGER:

Invisible and hazardous laser radiation when open and interlock failed or defeated. Avoid direct exposure to beam.

1. Read these instructions.
2. Keep these instructions.
3. Heed all warnings.
4. Follow all instructions.
5. Do not use this apparatus near water.
6. Clean only with dry cloth.
7. Do not block any ventilation openings. Install in accordance with the manufacturer's instructions.
8. Do not install near any heat sources such as radiators, heat registers, stoves, or other apparatus (including amplifiers) that produce heat.
9. Do not defeat the safety purpose of the polarized or grounding-type plug. A polarized plug has two blades with one wider than the other. A grounding type plug has two blades and a third grounding prong. The wide blade or the third prong are provided for your safety. If the provided plug does not fit into your outlet, consult an electrician for replacement of the obsolete outlet.
10. Protect the power cord from being walked on or pinched particularly at plugs, convenience receptacles, and the point where they exit from the apparatus.
11. Only use attachments / accessories specified by the manufacturer.
12. Unplug this apparatus during lightning storms or when unused for long periods of time.
13. Refer all servicing to qualified service personnel. Servicing is required when the apparatus has been damaged in any way, such as power-supply cord or plug is damaged, liquid has been spilled or objects have fallen into the apparatus, the apparatus has been exposed to rain or moisture, does not operate normally, has changed its performance, or has been dropped.
14. This appliance shall not be exposed to dripping or splashing water and that no object filled with liquids such as vases shall be placed on the apparatus.
15. Do not overload wall outlet. Use only power source as indicated.
16. Use replacement parts as specified by the manufacturer.
17. The product may be mounted to a wall only if recommended by the manufacturer.
18. Upon completion of any service or repairs to this product, ask the service technician to perform safety checks.

Dear Customer,

Please read this manual thoroughly before operating the unit to become more familiar with it and obtain the performance that will bring you continued enjoyment for many years. Keep these instructions handy for future reference.

PLEASE KEEP ALL PACKAGING MATERIAL FOR AT LEAST 90 DAYS IN CASE YOU NEED TO RETURN THIS PRODUCT TO YOUR PLACE OF PURCHASE OR MEMOREX.

For future reference, record the serial number of the unit printed on the rear of the cabinet.

Serial Number _____

INFORMATION:

This equipment has been tested and found to comply with the limits for a Class B digital device, pursuant to Part 15 of the FCC Rules. These limits are designed to provide reasonable protection against harmful interference in a residential installation. This equipment generates, uses, and can radiate radio frequency energy and, if not installed and used in accordance with the instructions, may cause harmful interference to radio communications. However, there is no guarantee that interference will not occur in a particular installation. If this equipment does cause harmful interference to radio or television reception, which can be determined by turning the equipment off and on, the user is encouraged to try to correct the interference by one or more of the following measures:

- Reorient or relocate the receiving antenna.
- Increase the separation between the equipment and receiver.
- Connect the equipment into an outlet on a circuit different from that to which the receiver is connected.
- Consult the dealer or an experienced radio/TV technician for help.

FCC WARNING:

This equipment may generate or use radio frequency energy. Changes or modifications to this equipment may cause harmful interference unless the modifications are expressly approved in the instruction manual. The user could lose the authority to operate this equipment if an unauthorized change or modification is made.

LASER SAFETY: This unit employs a laser. Only qualified service personnel should attempt to service this device due to possible eye injury.

CAUTION: USE OF CONTROLS, ADJUSTMENTS OR PERFORMANCE PROCEDURE HEREIN MAY RESULT IN HAZARDOUS RADIATION EXPOSURE.

SURGE PROTECTORS:

It is recommended to use a surge protector for AC connection. Lightning and power surges ARE NOT covered under warranty for this product.

LOCATION OF CONTROLS

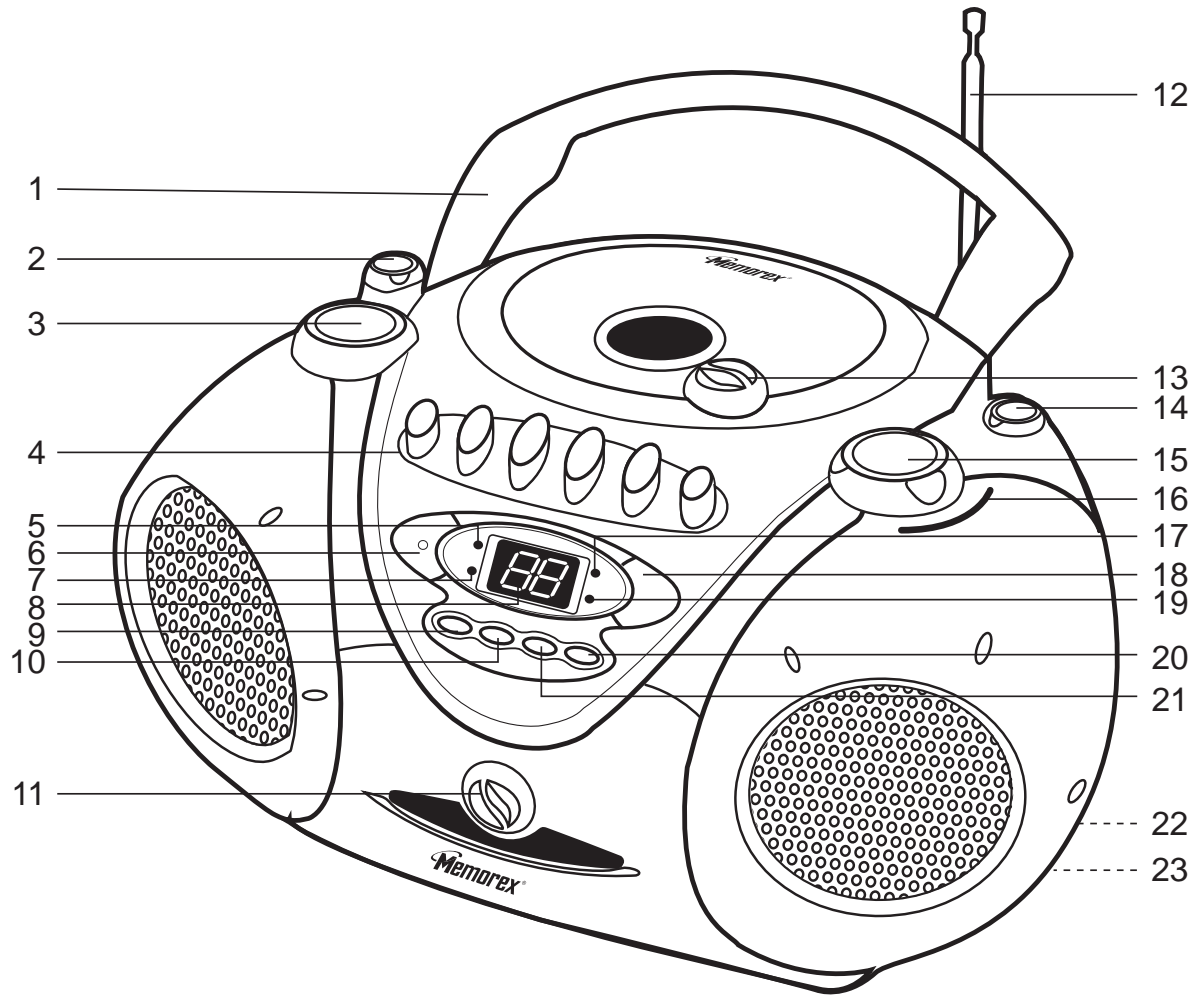

- | | |
|--------------------------------------|--|
| 1. Carrying Handle | 10. REPEAT Button |
| 2. FUNCTION Control | 11. Cassette OPEN/CLOSE Control |
| 3. VOLUME Control | 12. Antenna |
| 4. Cassette Buttons (left to right): | 13. CD OPEN Control |
| PAUSE () | 14. BAND Control |
| STOP (■) | 15. TUNING Control |
| REWIND (▶▶) | 16. Dial Scale and Pointer |
| FAST FORWARD (◀◀) | 17. FM STEREO Indicator |
| PLAY (◀) | 18. PLAY/PAUSE (▶/) Button |
| RECORD (●) | 19. PLAY/PAUSE Indicator |
| 5. REPEAT Indicator | 20. SKIP/Search +▶▶ Button |
| 6. STOP (■) Button | 21. SKIP/Search -◀◀ Button |
| 7. PROGRAM Indicator | 22. AC Jack (Rear of Unit) |
| 8. Display | 23. Battery Compartment (Rear of Unit) |
| 9. PROGRAM Button | |

POWER SOURCES

This unit is designed to operate on AC household current or DC (batteries).

AC:

Use the AC polarized line cord included with the unit for operation on AC power. Insert one end of the AC line cord into the AC power jack on the rear of the unit and the other end (with the 2 blades) into a conveniently located AC outlet having 120V, 60Hz. When the AC line cord is plugged in, the batteries will be disconnected.

NOTE: The AC plug supplied with the unit is polarized to help minimize the possibility of electric shock. If the AC plug does not fit into a nonpolarized AC outlet, do not file or cut the wide blade. It is the user's responsibility to have an electrician replace the obsolete outlet.

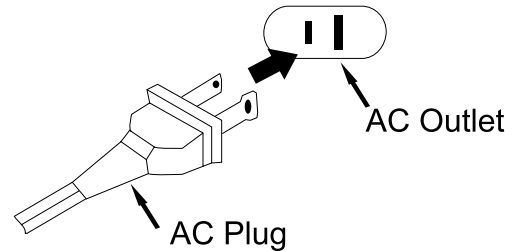

DC:

Remove the Battery Compartment cover by sliding it out. Insert eight (8) "C" cell batteries (not included), observing the battery polarity indicated inside the compartment. Replace the Battery Compartment cover.

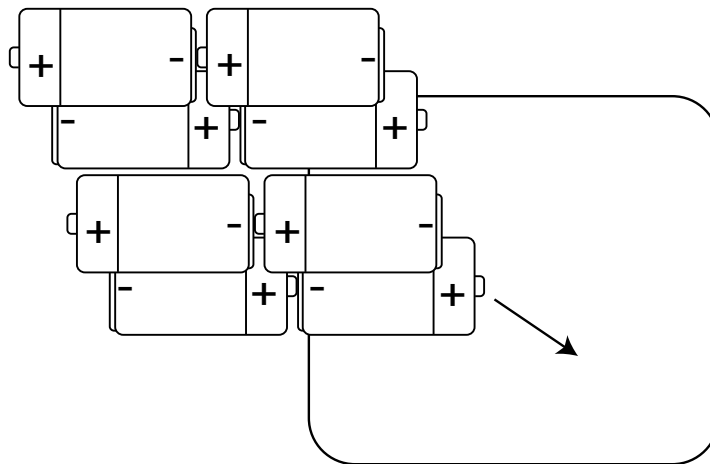

BATTERY PRECAUTIONS

Follow these precautions when using batteries in this device:

1. Use only the size and type of batteries specified.
2. Be sure to follow the correct polarity when installing the batteries as indicated in the battery compartment. Reversed batteries may cause damage to the device.
3. Do not mix different types of batteries together (e.g. Alkaline and Carbon-zinc) or old batteries with fresh ones.
4. If the device is not to be used for a long period of time, remove the batteries to prevent damage or injury from possible battery leakage.
5. Do not try to recharge batteries not intended to be recharged; they can overheat and rupture. (Follow battery manufacturer's directions.)

RADIO OPERATION

TO PLAY THE RADIO

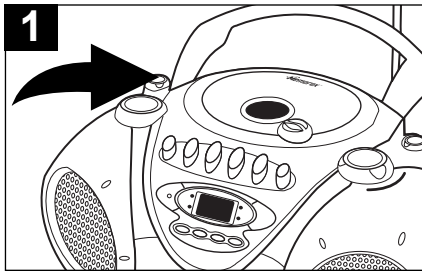

Rotate the **FUNCTION** control to the **RADIO** position.

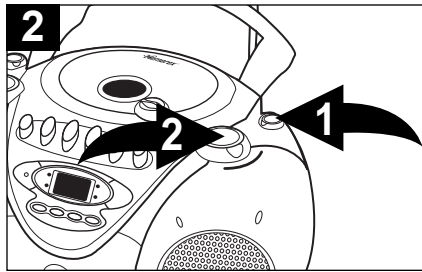

Rotate the **BAND** control ❶ to select **AM** or **FM**. Rotate the **TUNING** control ❷ to select a station.

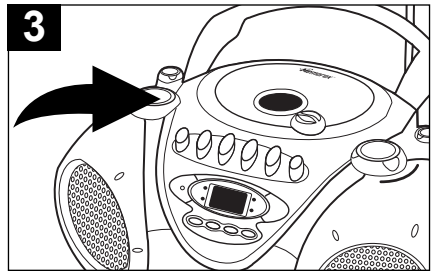

Adjust the **VOLUME** control as desired.

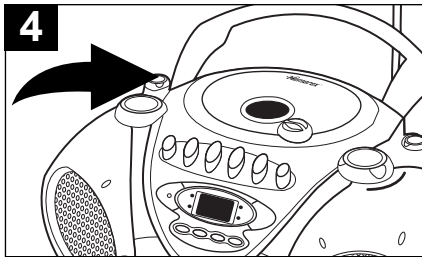

When you have finished listening, rotate the **FUNCTION** control to the **TAPE/OFF** position.

FM STEREO

When the **BAND** switch is set to the **FM** position and a strong **FM** stereo station is broadcasting, the **FM STEREO** indicator will light.

ANTENNAS

AM – This unit has a built-in ferrite rod antenna, which provides adequate reception in most areas. If reception is weak, turn the unit to improve reception.

FM – The **FM Rod Antenna** is for **FM** reception only. If reception is weak, adjust the length and the angle of the antenna.

COMPACT DISC (CD) OPERATION

TO INSERT A CD

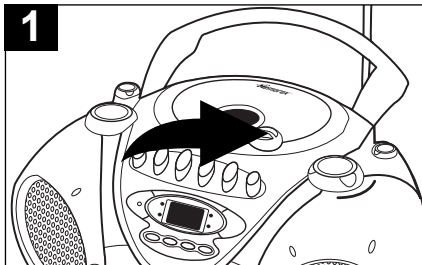

Rotate the **CD OPEN** control to the **OPEN** position to open the **CD** compartment door. Place a **CD** on the center spindle, with the printed label side facing up. Close the **CD** compartment door.

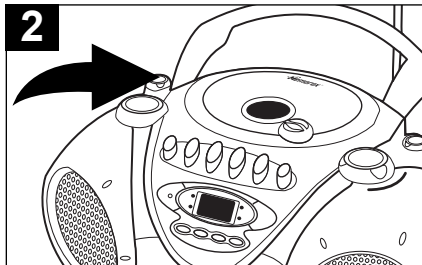

Rotate the **FUNCTION** control to the **CD** position.

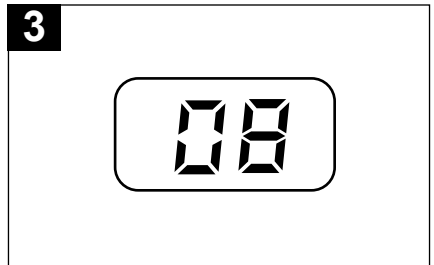

The total number of tracks will be displayed and the **CD** player will stop.

COMPACT DISC (CD) OPERATION (CONTINUED)

TO PLAY A CD (STANDARD CD, CD-R AND CD-RW CAN BE USED)

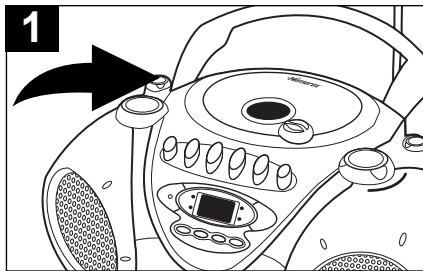

1 Rotate the FUNCTION control to the CD position. Insert a CD as described in the TO INSERT A CD section on page 5.

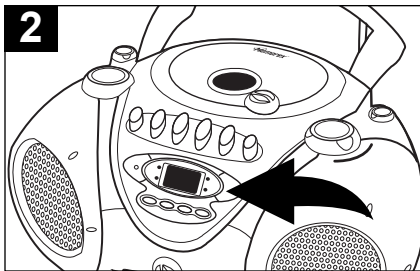

2 To play a disc from the beginning, press the PLAY/PAUSE (▶/||) button. Press the PLAY/PAUSE (▶/||) button again to pause playback; the PLAY/PAUSE indicator will blink.

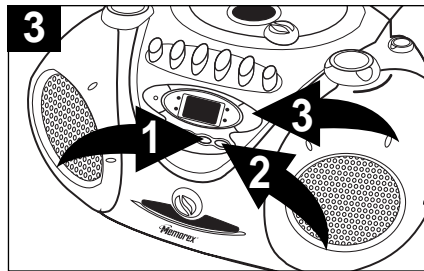

3 To start from a specific track, locate the track using the SKIP/Search – ◀◀ ❶ or + ▶▶ ❷ button and press the PLAY/PAUSE (▶/||) button ❸.

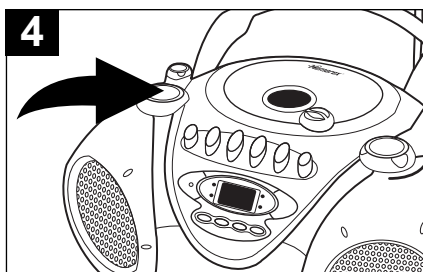

4 Adjust the VOLUME control as desired.

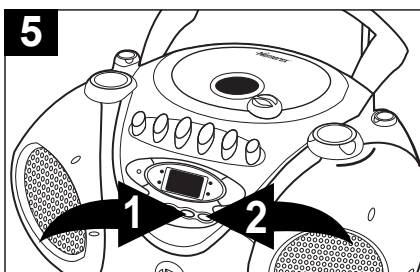

5 To skip forward or backward through the tracks on the disc, press the SKIP/Search – ◀◀ ❶ or + ▶▶ ❷ button.

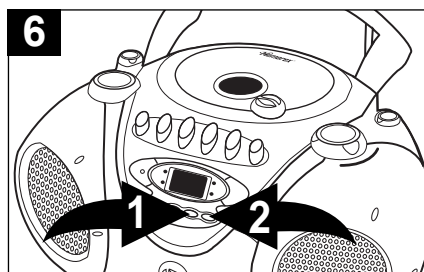

6 To search forward or backward through the disc, press and hold the SKIP/Search – ◀◀ ❶ or + ▶▶ ❷ button, a chattering noise will be heard.

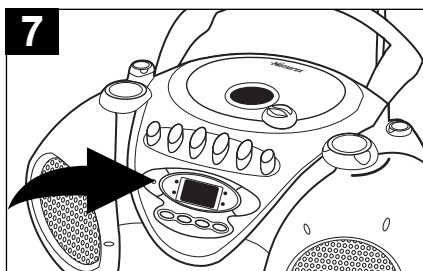

7 When the disc is through playing, it will stop rotating. Press the STOP (■) button to stop the disc before it is finished.

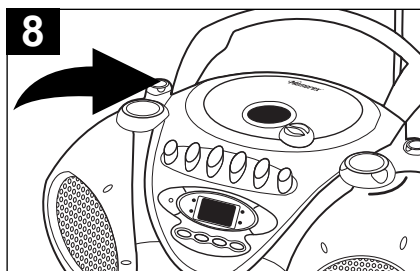

8 When you have finished listening, rotate the FUNCTION control to the TAPE/OFF position.

FAQS:

Do I need an adapter to play 3" singles?

No, simply insert the 3" single into the groove.

What is the maximum time for a CD in this unit?

The maximum time is 74 minutes.

What type of CDs can I play?

CD, CD-Rs and CD-RWs can be used.

NOTES:

- If a disc is inserted incorrectly, dirty, damaged or not present at all, it will not play.
- As each track is played, the track number is shown in the display.
- To prevent damage to the disc, never open the CD door while the disc is rotating. Wait for the disc to stop before opening the CD door. Never touch the lens when the CD compartment door is open.
- DO NOT use the carrying handle when playing a CD. The CD should only be used on a steady surface.

COMPACT DISC (CD) OPERATION (CONTINUED)

TO REPEATEDLY PLAY BACK ONE TRACK

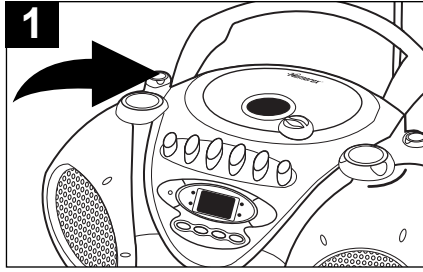

1 Rotate the FUNCTION control to the CD position. Insert a CD as described in the TO INSERT A CD section on page 5.

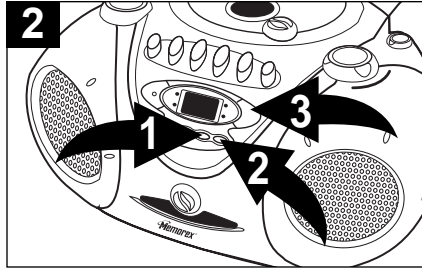

2 Select a track using the SKIP/Search – ◀ ① or + ▶▶ ② button and press the PLAY/PAUSE (▶/||) button ③.

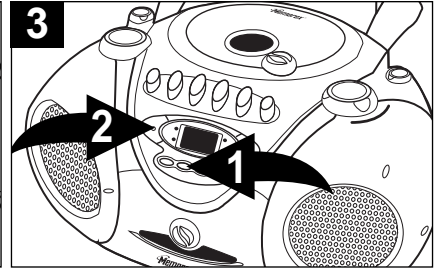

3 Press the REPEAT button ① once, the REPEAT indicator will blink and the unit will play the selected track over and over until the STOP (■) button ② is pressed.

TO REPEATEDLY PLAY BACK ALL TRACKS

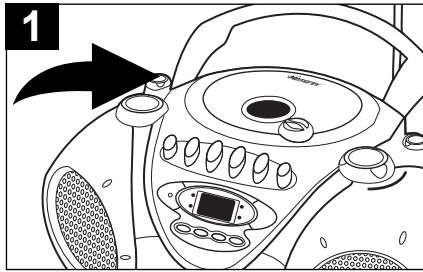

1 Rotate the FUNCTION control to the CD position. Insert a CD as described in the TO INSERT A CD section on page 5.

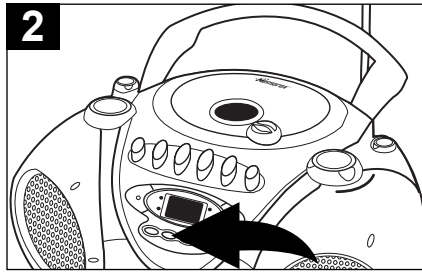

2 Press the REPEAT button twice, the REPEAT indicator will light.

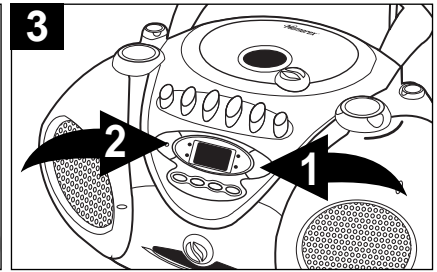

3 Press the PLAY/PAUSE (▶/||) button ① to begin playback and the unit will play the entire disc over and over until the STOP (■) button ② is pressed.

NOTE:

To stop and cancel Repeat playback, press the STOP (■) button.

COMPACT DISC (CD) OPERATION (CONTINUED)

TO PROGRAM THE MEMORY (UP TO 19 TRACKS)

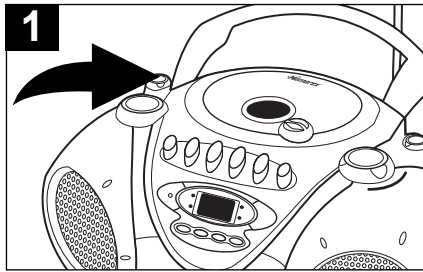

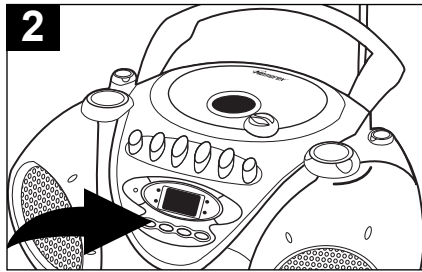

1 Rotate the FUNCTION control to the CD position. Insert a CD as described in the TO INSERT A CD section on page 5.

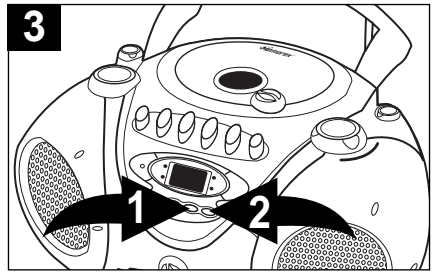

2 Press the PROGRAM button, the PROGRAM indicator will blink.



3 Use the SKIP/Search -  or +  button to select the first track to be programmed.

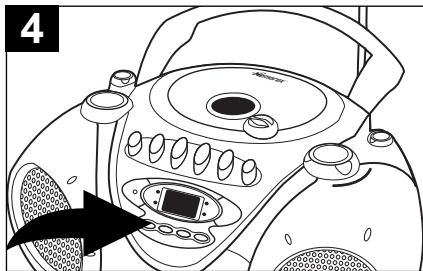

4 Press the PROGRAM button again; the selected track has now been programmed and counted as program 1.

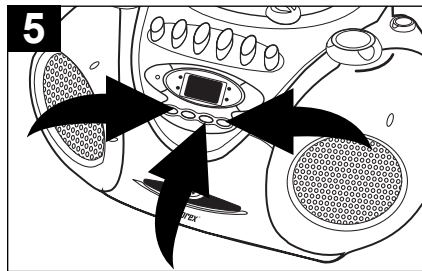



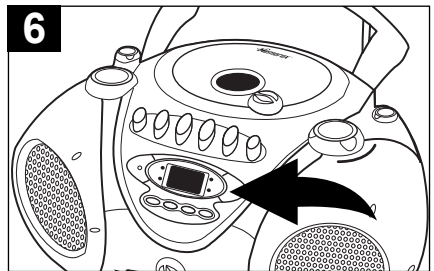



5 Repeat steps 3 and 4 to program the other desired tracks in sequence (up to 19 tracks).



6 Press the PLAY/ PAUSE () button to begin playback; the PROGRAM indicator will light and the tracks will play in the order programmed.

NOTES:

- Programming is the ability to preselect the order in which a series of tracks will be played.
- Each track may be stored in the program memory as many times as desired (up to 19 tracks).
- As each track is played, its track number will be displayed. You can move forward or backward through the programmed tracks with the SKIP/Search +  or -  button.
- The CD player will stop after all programmed tracks have been played or the STOP () button is pressed. If the STOP () button was pressed, the programmed tracks will remain in memory. Simply press the PROGRAM button and then the PLAY/PAUSE () button to continue Program playback.
- To cancel Program playback, press the PROGRAM button to enter the Program mode and then press the STOP () button, or open the CD door.
- When 19 tracks have been programmed, the CD memory is full (" - " will appear in the display).

CASSETTE TAPE OPERATION

PLAYING CASSETTE TAPES

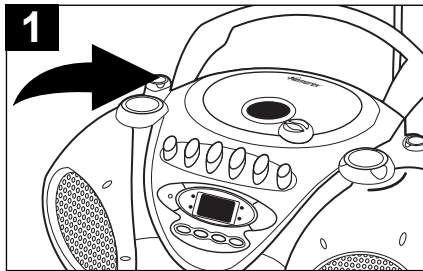

1 Rotate the FUNCTION control to the TAPE position.

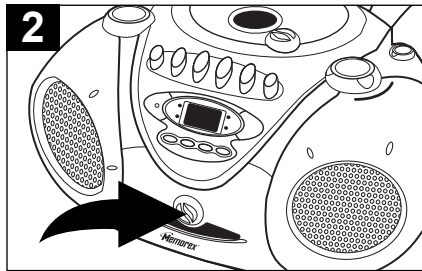

2 Rotate the Cassette OPEN/CLOSE control clockwise to open the Cassette Door.

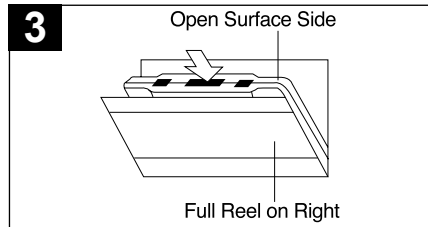

3 Insert a pre-recorded cassette into the slots in the Cassette Door with the open end facing up and the full reel on the right side. Close the cassette door then rotate the Cassette OPEN/CLOSE control counter-clockwise to the CLOSE position.

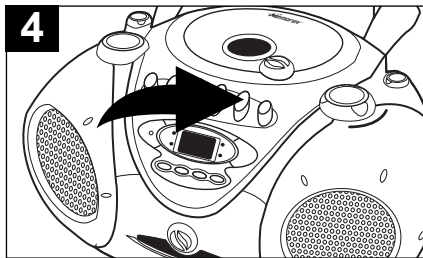

4 Press the PLAY (▶) button to begin playback.

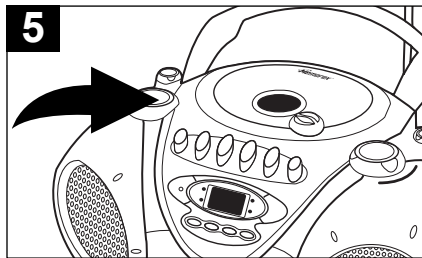

5 Adjust the VOLUME control as desired.

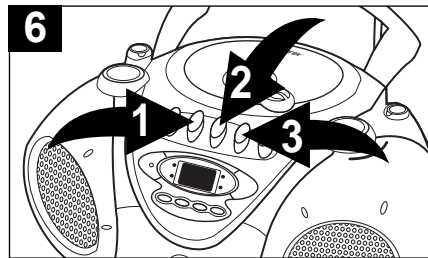

6 To advance or rewind the tape rapidly, press either the F.FWD (▶▶) ❶ or REWIND (◀◀) ❷ button. When you reach the desired point, press the PLAY (▶) button ❸ to resume normal playback.

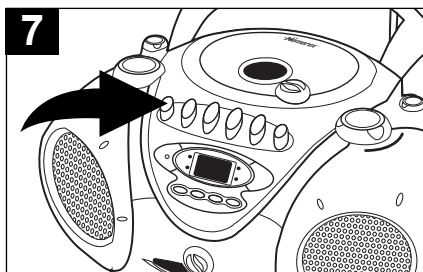

7 To pause playback momentarily, press the PAUSE (||) button. The tape movement stops but the tape motor is still running. Press the PAUSE (||) button again to release pause and resume normal playback.

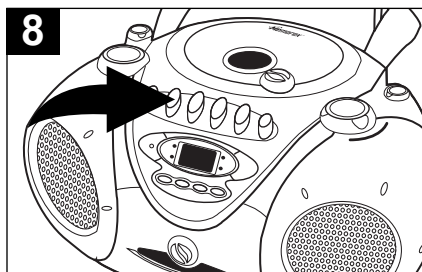

8 To stop playback before the tape ends, press the STOP (■) button. The PLAY (▶) button is released and the tape motor shuts off.

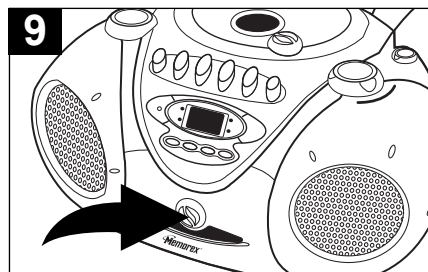

9 When the tape reaches the end, the auto-stop mechanism activates, the PLAY (▶) button is released and the tape motor shuts off. Close the cassette door then rotate the Cassette OPEN/CLOSE control counter-clockwise to the CLOSE position.

CASSETTE TAPE OPERATION (CONTINUED)

MAKING A TAPE RECORDING

The tape recorder in this system allows you to make direct recordings from the radio or CD player to a blank cassette in the tape compartment. An automatic recording volume level control (ALC) circuit will automatically control the volume level of your recordings to prevent distortion. You may change the settings of the volume or the Stereo-Wide controls during a tape recording, as these controls have no effect on the material being recorded onto the tape.

To make a tape recording, proceed as follows:

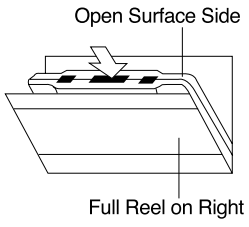
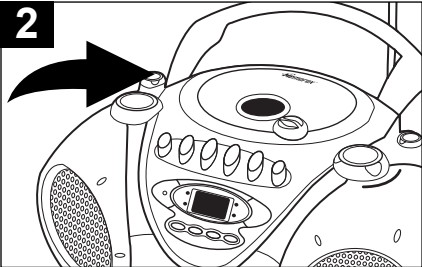
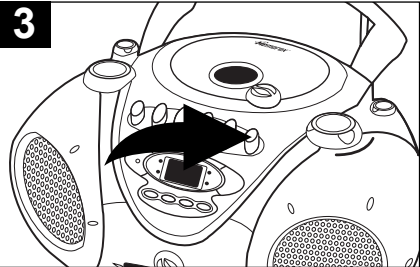
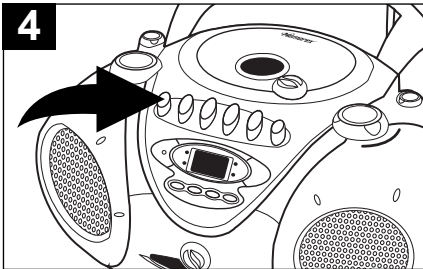
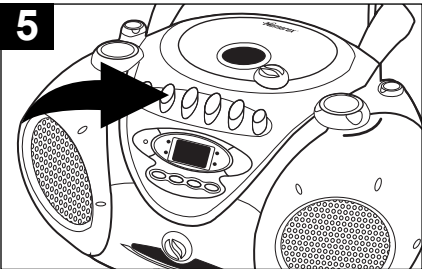
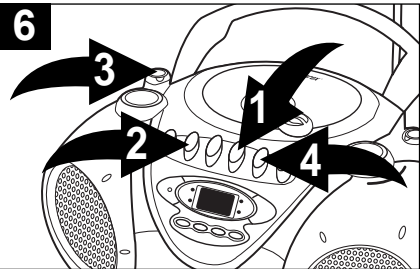
<p>1</p>  <p>Open Surface Side</p> <p>Full Reel on Right</p>	<p>2</p> 	<p>3</p> 
<p>Open the Cassette Door and insert a good quality blank cassette tape into the slots on the door, with the open end facing up and the full reel on the right-hand side. Close the Cassette Door.</p>	<p>Rotate the FUNCTION control to select the function you wish to record, either RADIO or CD, and operate that function according to its own instructions.</p>	<p>When you are ready to begin recording, press the RECORD (●) button. The PLAY (◀) button will also engage. The tape will begin moving and all of the material from your selected source will be recorded on the tape.</p>
<p>4</p> 	<p>5</p> 	<p>6</p> 
<p>To avoid recording unwanted material, such as radio commercials, use the PAUSE () button to stop the recording temporarily. Release the PAUSE () button to begin recording again.</p>	<p>When you are finished recording, press the STOP (■) button to stop the tape.</p>	<p>If you wish to listen to your recording immediately, press the cassette REWIND (▶▶) button ❶ until the tape rewinds to the beginning, then press the STOP (■) button ❷. Rotate the FUNCTION control ❸ to the TAPE position and press the PLAY (▶) button ❹ to begin playback.</p>

CARE AND MAINTENANCE

SAFEGUARD AGAINST ACCIDENTAL ERASURE

When a new recording is made, any program material previously recorded is automatically erased and only the new recording remains. To safeguard valuable recordings from being erased accidentally, the cassette and the deck are equipped with a special device.

On the back of the cassette there is an erase prevention tab on each side. To prevent accidental erasing, break out these tabs with a screwdriver. If only one side of the tape is to be protected, break out the tab on the left side with the side desired facing you.

To record on a tape in which the tab has been broken, place a piece of adhesive tape over that area.

NOTE: When a tab is broken out, the record button cannot be depressed.

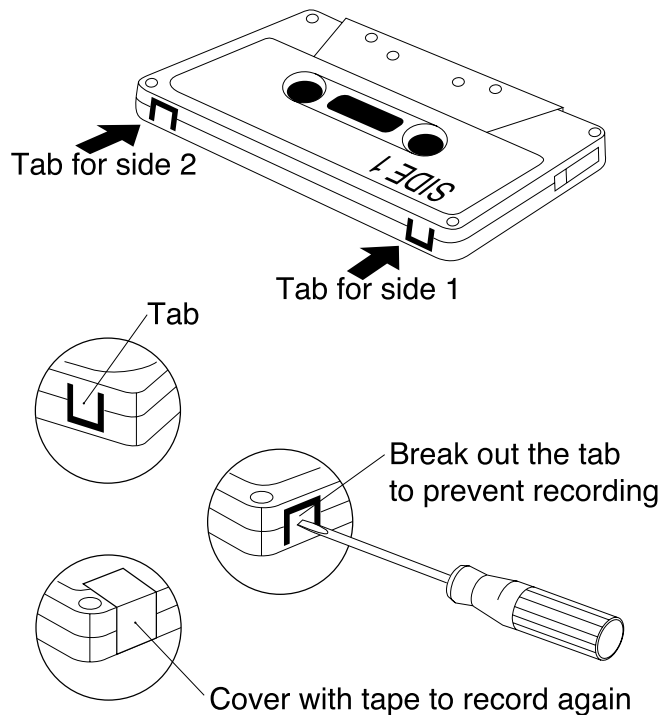

CASSETTE TAPE RECOMMENDATIONS

Standard tape lengths have 15 (C-30), 30 (C-60) and 45 (C-90) minutes of recording time on each side. Longer length tapes of 60 (C-120) minutes of recording time on each side are not recommended. Use only high quality tapes. If a problem develops, check the unit first with another cassette to determine if the problem is with the cassette, and not with the unit.

If there is any slack in the cassette, it should be removed before inserting the cassette. Place a pencil in one of the hubs and rotate it clockwise until all slack is taken up.

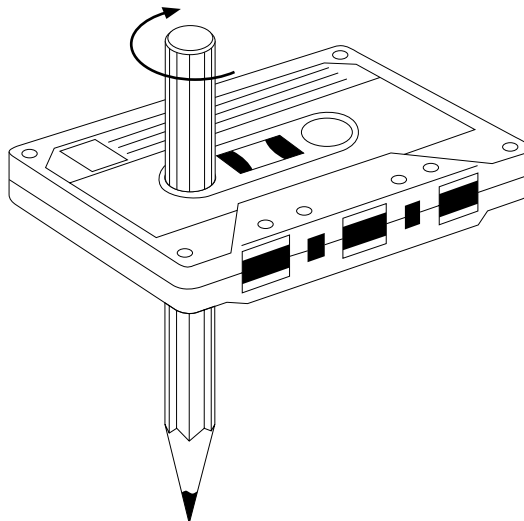

CARE AND MAINTENANCE (CONTINUED)

Caring for Compact Discs

- Treat the compact disc carefully. Handle the compact disc only by its edges. Never allow your fingers to come in contact with the shiny, unprinted side of the compact disc.
- Do not attach adhesive tape, stickers, etc. to the compact disc label.
- Clean the compact disc periodically with a soft, lint-free, dry cloth. Never use detergents or abrasive cleaners to clean the compact disc. If necessary, use a CD cleaning kit.
- If a compact disc skips or gets stuck on a section of the compact disc, it is probably dirty or damaged (scratched).
- When cleaning the compact disc, wipe in straight lines from the center of the compact disc to the outer edge of the compact disc. Never wipe in circular motions.

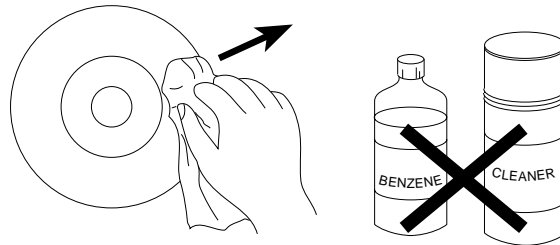
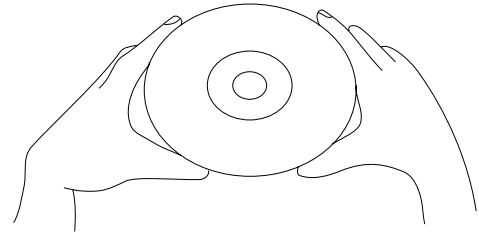

- This unit is designed to play only compact discs bearing the identification logo as shown here.  Other compact discs may not conform to the CD standard and may not play properly.
- Compact discs should be stored in their cases after each use to avoid damage.
- Do not expose compact discs to direct sunlight, high humidity, high temperatures, or dust, etc. Prolonged exposure or extreme temperatures can warp the compact disc.
- Do not stick or write anything on either side of the compact disc. Sharp writing instruments, or the ink may damage the surface.

Cleaning the unit

- To prevent fire or shock hazard, disconnect your unit from the AC power source when cleaning.
- The finish on your unit may be cleaned with a dust cloth and cared for as other furniture. Use caution when cleaning and wiping the plastic parts.
- Mild soap and a damp cloth may be used on the front panel.
- Periodic cleaning of the tape heads, capstan and pinch roller is necessary to maintain good sound reproduction. Clean them after every 100 hours of use or less if playback has deteriorated. Use a cotton swab moistened with head cleaning solution or isopropyl alcohol, then wipe dry with another swab.

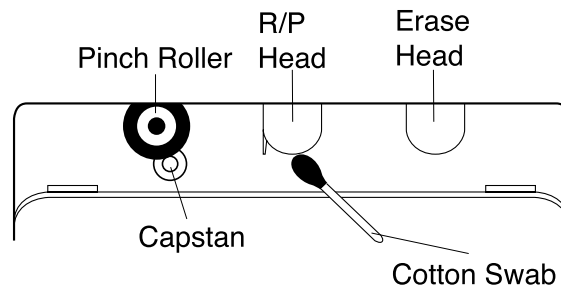

NOTE: Never use metal objects on or near the tape heads. Do not allow any cleaning material to fall into the tape assembly.

TROUBLESHOOTING GUIDE

Should this unit exhibit a problem, check the following before seeking service:

Symptom	Possible Cause	Solution
Radio		
Noise or sound distorted on radio broadcasts.	Station not tuned properly for AM or FM.	Retune the AM or FM broadcast station.
	FM: Telescopic antenna is not properly adjusted.	Reorient FM telescopic antenna.
	AM: Unit is not positioned correctly.	Rotate unit until best reception is obtained.
AM or FM, no sound.	BAND control not on AM or FM.	Rotate to select AM or FM.
	Volume at minimum.	Increase volume.
Cassette Player		
No sound.	FUNCTION control not set to TAPE.	Rotate to the TAPE position.
	Volume at minimum.	Increase volume.
Sound distorted.	Dirty head.	Clean the head.
Speed varies.	Tape old or worn.	Replace the tape.
	Batteries are low.	Replace the batteries.
Cassette Recorder		
Will not record.	Erase prevention tab removed.	Cover hole with adhesive tape.
Distorted sound on playback.	Defective tape or dirty tape head.	Replace tape or clean tape head.
Compact Disc Player		
CD Player will not play.	FUNCTION control not set to CD.	Rotate to the CD position.
	CD is not installed or installed upside-down.	Insert CD with label side up.
CD skips while playing.	Disc is dirty or scratched.	Wipe disc with cloth or use another disc.
General		
No sound.	Power cord disconnected.	Connect power cord.
	No batteries, or batteries not installed properly.	Insert fresh batteries properly.

**FOR ADDITIONAL SET-UP OR OPERATING ASSISTANCE, PLEASE VISIT OUR WEBSITE AT
WWW.MEMCORPINC.COM
OR CONTACT CUSTOMER SERVICE AT 1-800-919-3647.**

PLEASE KEEP ALL PACKAGING MATERIAL FOR AT LEAST 90 DAYS IN CASE YOU NEED TO RETURN THIS PRODUCT TO YOUR PLACE OF PURCHASE OR MEMOREX.

FOR PARTS AND ACCESSORIES, CONTACT FOX INT'L AT 1-800-321-6993.

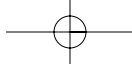

SPECIFICATIONS

GENERAL:

Power Source120V, 60Hz AC
Battery12V DC (8 x 1.5V "C" Size batteries)
Alkaline is recommended for longer life
Speaker8 Ohms

RADIO SECTION:

Frequency Range (FM).....88 - 108MHz
Frequency Range (AM).....530 - 1710kHz

CD SECTION:

Disc Diameter4.72" (120mm)
3.15" (80mm) Single CD
Optical Source.....Semiconductor Laser

Specifications are subject to change without notice.

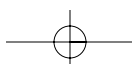
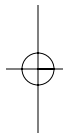
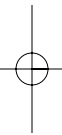

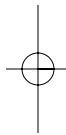
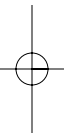

Memcorp, Inc.
Weston, FL
Printed in Hong Kong

Visit our website at www.memcorpinc.com

