

TANDBERG 3000 *MXP*

User Manual



Software version F1
D13357.01

This document is not to be reproduced in whole or in part without permission in writing from:

TANDBERG

Table Of Contents

User Manual	1
Trademarks and Copyright	1
Environmental Issues	2
Operator Safety Summary	3
1 Introduction	5
1.1 At a Glance	6
1.2 Menu Structure	8
2 Installation	10
2.1 Unpacking and Mounting	11
2.2 Connecting Cables	12
2.3 Monitor Configuration	13
2.4 System Configuration	14
3 General Use	16
3.1 The Welcome Screen	17
3.2 Using the Remote Control	18
3.2.1 Navigation	19
3.2.2 Selfview	19
3.2.3 Layout	19
3.2.4 Mic Off	21
3.2.5 Volume + and -	21
3.2.6 Number and Letter keys	22
3.2.7 Touch Tones	22
3.3 On Screen Indicators	23
3.4 Using the Menu	24
3.5 Make a Call	25
3.5.1 Video Call	25
3.5.2 Telephone Call	26
3.5.3 Add Call	26
3.5.4 Call Settings	27
3.6 Answer an incoming Call	30
3.7 End Call	31
3.8 Standby	32
3.8.1 Delay Auto-Standby for 1 hour	32
3.8.2 Delay Auto-Standby for 3 hours	32
3.8.3 Do Not Disturb	32
3.9 Phone Book	33
3.9.1 Global Phone Book	34
3.9.2 New	34
3.9.3 MultiSite	35
3.9.4 Edit	37
3.9.4 Edit	37
3.9.5 Delete	37
3.10 Move Camera	38
3.10.1 Zoom	38
3.10.2 Far End Camera Control	38
3.10.3 Camera Presets	39
3.11 Presentation	41
3.11.1 Presentation Key	41
3.11.2 Presentation Menu	42
3.11.3 PC Presenter (DVI/XGA Input)	43
3.11.4 PC Soft Presenter and VNC	44
3.11.5 Duo VideoTF/H.239	45
3.11.6 Take New Snapshot	46
3.11.7 Display Snapshot	46
3.12 MultiSite Services	47
3.12.1 Request Floor and Release Floor	48
3.12.2 MultiSite Layout	48

3.12.3 Terminal Names	49
3.12.4 Chair Control	49
3.12.5 Assign Floor and Release Floor from Participant	50
3.12.6 View Site and End View	50
3.12.7 Disconnect Participant	50
3.12.8 Terminate Meeting	50
3.12.9 More about MultiSite (embedded MCU).....	50
3.13 Control Panel	53
3.13.1 User Guide	53
3.13.2 Streaming	54
3.13.3 Far End Control.....	55
3.13.4 Camera Preset	56
3.13.5 Camera Tracking.....	56
3.13.6 Text Chat.....	57
3.13.7 System Information	58
3.13.8 Administrator Settings	58
3.13.9 Restart.....	58
4 Administrator Settings	59
4.1 General Settings	60
4.1.1 Language	60
4.1.2 System Name.....	61
4.1.3 Dual Monitor	61
4.1.4 Autoanswer	61
4.1.5 Max Call Length	62
4.1.6 Global Phone Book Settings	62
4.1.7 Permissions.....	62
4.1.8 Screen Settings	63
4.1.9 Software Options.....	67
4.2 Menu Settings	68
4.2.1 Menu Timeout In Call	68
4.2.2 Welcome Menu	69
4.2.3 Welcome Picture	69
4.2.4 Logo.....	69
4.2.5 Menu on TV.....	70
4.2.6 Menu on PC	70
4.2.7 Display Welcome Text.....	70
4.2.8 Welcome Text	70
4.2.9 Administrator Password	71
4.3 Presentation Settings.....	72
4.3.1 Presentation Start.....	72
4.3.2 H.239.....	73
4.3.3 Startup Video Source	73
4.3.4 Presentation Source.....	73
4.3.5 Snapshot Source.....	73
4.3.6 Auto-Display Snapshot.....	74
4.3.7 PIP Appearance	74
4.3.8 PIP Placing.....	74
4.3.9 VNC Settings.....	75
4.4 Call Quality.....	76
4.4.1 Video Algorithm	76
4.4.2 Audio Algorithm	77
4.4.3 AAC-LD 128kbps (stereo audio)	78
4.4.4 Natural Video.....	78
4.4.5 Video Quality	78
4.4.6 Default Call Settings.....	79
4.5 Audio	80
4.5.1 Inputs.....	80
4.5.2 Outputs.....	81
4.5.3 Echo Control.....	82
4.5.4 Stereo Settings.....	83

4.5.5 Audio Leveling (AGC).....	83
4.5.6 Alert Tones and Volume.....	84
4.6 Video.....	85
4.6.1 Camera Tracking Mode.....	85
4.6.2 MCU Status Line.....	86
4.6.3 Floor to Full Screen.....	86
4.6.4 Web Snapshots.....	86
4.6.5 MultiSite Picture Mode.....	87
4.6.6 Picture Control.....	88
4.6.7 Video Name.....	88
4.7 Security.....	89
4.7.1 Encryption.....	89
4.7.2 Encryption Mode.....	90
4.7.3 Passwords.....	90
4.8 Network.....	91
4.8.1 ISDN-BRI Settings.....	91
4.8.2 LAN Settings.....	93
4.8.3 Network Profiles.....	97
4.8.4 Data Port.....	98
4.9 Diagnostics.....	99
4.9.1 System Information.....	99
4.9.2 Call Status.....	99
4.9.3 Channel Status.....	100
4.9.4 System Selftest.....	101
4.9.5 View Administrator Settings.....	101
4.9.6 Restore Default Settings.....	105
4.9.7 IP Address Conflict Check.....	105
5 Peripheral Equipment.....	106
5.1 Interfaces.....	107
5.2 Document Camera.....	108
5.3 Video Cassette Recorder (VCR).....	109
5.4 Telephone Add-On.....	110
5.5 Additional Cameras.....	111
5.6 Additional Microphones.....	112
5.7 Web Interface.....	113
5.8 Dual Monitor.....	114
5.9 XGA Monitors and Projectors.....	115
5.10 VESA Display Power Management.....	116
5.11 Extended Display Identification Data (EDID).....	117
6 Appendix.....	118
6.1 Appendix 1.....	119
6.2 Appendix 2.....	120
6.3 Appendix 3.....	121
6.4 Appendix 4.....	122
6.5 Appendix 5.....	123
6.6 Appendix 6.....	125
6.7 Appendix 7.....	127
6.8 Appendix 8.....	130
6.9 Appendix 9.....	133
6.10 Appendix 10.....	134
6.11 Appendix 11.....	136
Glossary.....	137
Index.....	145

Trademarks and Copyright

All rights reserved. This document contains information that is proprietary to TANDBERG. No part of this publication may be reproduced, stored in a retrieval system, or transmitted, in any form, or by any means, electronically, mechanically, by photocopying, or otherwise, without the prior written permission of TANDBERG. Nationally and internationally recognized trademarks and tradenames are the property of their respective holders and are hereby acknowledged.

Portions of this software are © 1996-2004 RADVISION Ltd. All intellectual property rights in such portions of the Software and documentation are owned by RADVISION and are protected by United States copyright laws, other applicable copyright laws and international treaty provisions. RADVISION and its suppliers retain all rights not expressly granted.

Disclaimer

The information in this document is furnished for informational purposes only, is subject to change without prior notice, and should not be construed as a commitment by TANDBERG. The information in this document is believed to be accurate and reliable; however TANDBERG assumes no responsibility or liability for any errors or inaccuracies that may appear in this document, nor for any infringements of patents or other rights of third parties resulting from its use. No license is granted under any patents or patent rights of TANDBERG.

This document was written by the Product and Sales Support Department of TANDBERG, Norway. We are committed to maintaining a high level of quality in all our documentation. Towards this effort, we welcome your comments and suggestions regarding the content and structure of this document. Please fax or mail your comments and suggestions to the attention of:

Product and Sales Support Department
TANDBERG
P.O. Box 92
1325 Lysaker
Norway
Tel: +47 67 125 125
Fax: +47 67 125 234

COPYRIGHT © 2004, TANDBERG

Environmental Issues

Thank you for buying a product, which contributes to a reduction in pollution, and thereby helps save the environment. Our products reduce the need for travel and transport and thereby reduce pollution. Our products have either none or few consumable parts (chemicals, toner, gas, paper). Our products are low energy consuming products.

Battery handling

Batteries for the Remote Control are Long Life and Alkaline batteries saving the environment; please follow guidelines on the packing material for handling and disposal of the batteries.

Waste handling

No need to send material back to TANDBERG as there are no consumables to take care of. Please contact your local dealer for information on recycling the product by sending the main parts of the product for disassembly at local electronic waste stations, marking recyclable parts so the waste station can disassemble and re-use these parts.

Production of products

Our factories employ the most efficient environmental methods for reducing waste and pollution and ensuring the products are recyclable.

Operator Safety Summary

For your protection, please read these safety instructions completely before operating the equipment and keep this manual for future reference. The information in this summary is intended for operators. Carefully observe all warnings, precautions and instructions both on the apparatus and in the operating instructions.

Equipment Markings

The lightning flash symbol within an equilateral triangle is intended to alert the user to the presence of uninsulated “dangerous voltages” within the product’s enclosure that may be of sufficient magnitude to constitute a risk of electrical shock.

The exclamation mark within an equilateral triangle is intended to alert the user to the presence of important operating and maintenance (servicing) instructions within literature accompanying the equipment.

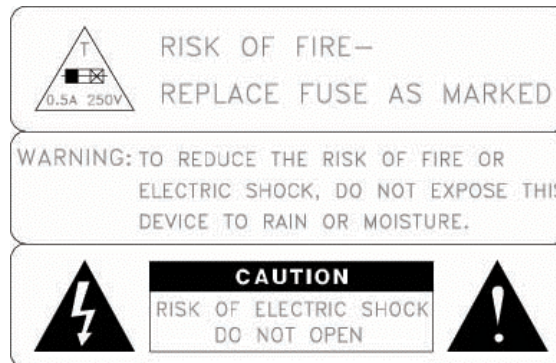

Warnings

- Water and moisture - Do not operate the equipment under or near water - for example near a bathtub, kitchen sink, or laundry tub, in a wet basement, or near a swimming pool or in areas with high humidity.
- Cleaning - Unplug the apparatus from the wall outlet before cleaning or polishing. Do not use liquid cleaners or aerosol cleaners. Use a lint-free cloth lightly moistened with water for cleaning the exterior of the apparatus.
- Ventilation - Do not block any of the ventilation openings of the apparatus. Install in accordance with the installation instructions. Never cover the slots and openings with a cloth or other material. Never install the apparatus near heat sources such as radiators, heat registers, stoves, or other apparatus (including amplifiers) that produce heat.
- Grounding or Polarization - Do not defeat the safety purpose of the polarized or grounding-type plug. A polarized plug has two blades with one wider than the other. A grounding type plug has two blades and a third grounding prong. The wide blade or third prong is provided for your safety. If the provided plug does not fit into your outlet, consult an electrician.
- Power-Cord Protection - Route the power cord so as to avoid it being walked on or pinched by items placed upon or against it, paying particular attention to the plugs, receptacles, and the point where the cord exits from the apparatus.
- Attachments - Only use attachments as recommended by the manufacturer.
- Accessories - Use only with a cart, stand, tripod, bracket, or table specified by the manufacturer, or sold with the apparatus. When a cart is used, use caution when moving the cart/apparatus combination to avoid injury from tip-over.
- Lightning - Unplug this apparatus during lightning storms or when unused for long periods of time.
- ISDN cables - CAUTION - To reduce the risk of fire, use only No. 26 AWG or larger telecommunication line cord.

- Servicing - Do not attempt to service the apparatus yourself as opening or removing covers may expose you to dangerous voltages or other hazards, and will void the warranty. Refer all servicing to qualified service personnel.
- Damaged Equipment - Unplug the apparatus from the outlet and refer servicing to qualified personnel under the following conditions:
 - When the power cord or plug is damaged or frayed
 - If liquid has been spilled or objects have fallen into the apparatus
 - If the apparatus has been exposed to rain or moisture
 - If the apparatus has been subjected to excessive shock by being dropped, or the cabinet has been damaged
 - If the apparatus fails to operate in accordance with the operating instructions

1 Introduction

The TANDBERG 3000 MXP system offers superior audio and video quality in a fully featured unit. MXP stands for Media Experience and indicates the new TANDBERG platform.

Main Features:

- Supports videoconferencing via both IP and ISDN networks.
- Selection of up to 2 Mbps call quality per call, and up to 2,3 Mbps for a MultiSite call totally.
- Built-in MultiSite^{TF*}:
 - A maximum of 4 sites + 3 additional telephone calls can participate in joint meetings.
 - Auto Split, Voice Switched, 4 Split and 3+1 Split picture modes supported.
 - Any combination of ISDN and IP participants is possible.
 - Supporting H239, DuoVideo, Encryption and H264
 - The TANDBERG videoconferencing system can also be used purely as an audio-bridge (with an ISDN connection).
- Natural Presenter Package* (NPP) consisting of:
 - Duo Video^{TF} - allows participants at the far end to simultaneously watch a presenter on one screen and a live presentation on the adjoining screen.
 - Digital Clarity^{TF} - participants enjoy presentations of exceptionally high quality resolution video.
 - PC Presenter^{TF} - an easily accessible PC connection over Ethernet that supports up to XGA resolution.
 - PC SoftPresenter^{TF} - show PC images via your LAN connection supporting XGA resolution.
- Secure Conference^{TF} - Embedded encryption for both Point-to-Point and MultiSite call privacy and security.
- Natural Video^{TF} – provides 60 fields per second true interlaced picture.
- Downspeeding^{TF} - if channels are dropped during a videoconferencing session, the connection is automatically maintained without interruption.
- Streaming – allows broadcasting of audio/video via an IP network.
- Web-interface for streaming, text chat/closed captioning, system management, diagnostics and software uploads.
- Worldwide compatibility with other standards-based videoconferencing systems.

What's new:

- New Graphical User Interface including new Remote Control
- High quality audio (MPEG-4 AAC-LD)
- SXGA input and XGA output through DVI-I (analog or digital)
- Advanced Screen Layout: Support for dual monitor setup (Side-by-Side) and Picture outside Picture support.
- Integrator friendly through XML and SOAP protocols
- Up to 4 video sites + 3 telephone sites in a MultiSite call (Including Host)
- Transcoding and Multirate: Supports different call rates for all sites in a MultiSite
- H.264 video compression in point-to-point and MultiSite
- DuoVideo or/and H.239 from any site in a MultiSite (independent of picture layout)
- Voice Switched, 4-split or 3+1-split picture layouts in MultiSite
- Higher bandwidth, up to 2Mbps call quality per call, and up to 2,3 Mbps for a MultiSite call totally.
- VESA Display Power Management to suspend (switch off) external VGA displays

* - optional feature. To check which options are installed, choose System Information from the Control Panel.

TF- TANDBERG first.

1.1 At a Glance

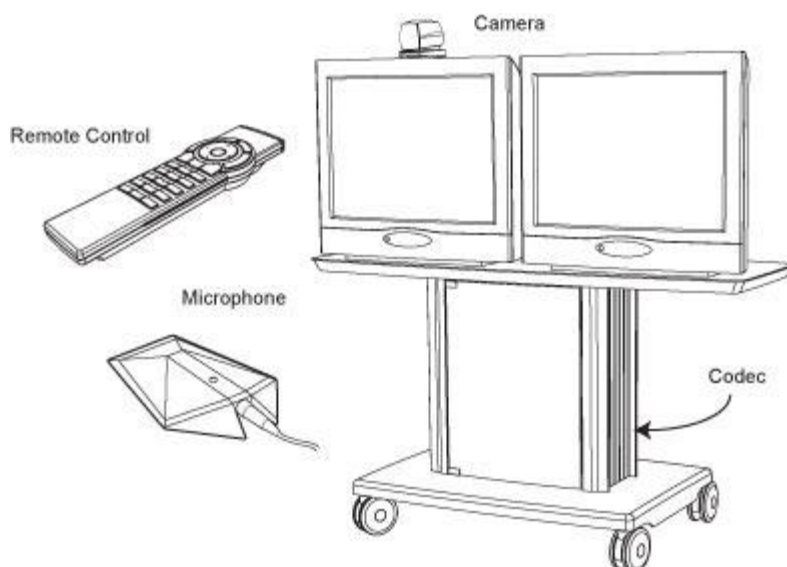

Camera

The Main Camera is mounted on top of the monitor. The Main Camera includes a high quality color camera with a fast pan/tilt/zoom action. The Main Camera is controlled by the system's infra-red remote control and operates pan/tilt, focus and zoom.

Monitors

The monitor displays the far-end and near-end videoconferencing sites in addition to the menus, video from connected video sources and high-resolution images. You can also connect a second monitor for displaying self-view, still images and Duo Video.

Codec

The Codec is the heart of the system. The main task for the Codec is the compression of outgoing video, audio and data, the transmission of this information to the far end and the decompression of the incoming information. Hence the name Codec.

Cabinet

The cabinet is easily movable with large wheels and handles. The Codec is located inside the cabinet. Inside the cabinet there is room for additional equipment, e.g. a VCR.

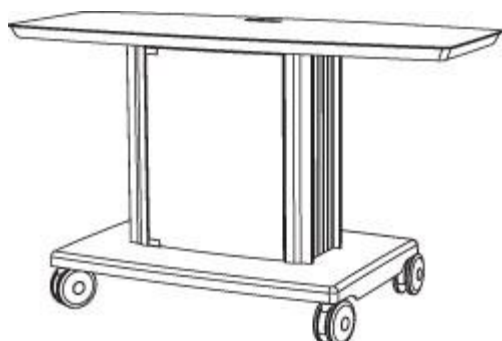

Remote Control

The remote control is used to control all functions of the system. If the screen saver is activated (black monitor), touching the remote control will automatically wake up the system. The remote control uses 4 AAA batteries. The system will tell you when batteries are running low. Change batteries from the backside of the remote control.

The reach of the remote control signal is 20 meters. For users sitting in an open plan office, this can cause problems. Use the little, white switch placed under the batteries to change the reach of the signal from 20 meters to 2 meters. This will prevent you from unintentionally controlling your neighbor's video system, when you control your own system.

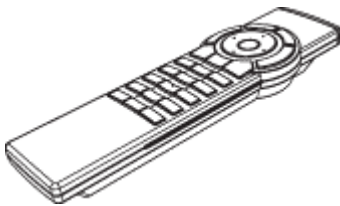

Microphone

The high quality table microphone is designed to use on a table during a videoconference. You can connect up to three microphones. The ideal location for the microphone is on a flat surface at least 2m (6.5 ft) from the front of the system. The microphone cable should always point towards the system. The system will automatically equalize sound levels. Loud and soft voices are picked up and transmitted to the far end at approximately the same level.

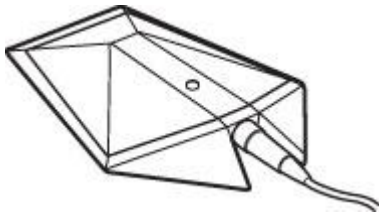

1.2 Menu Structure

The menu structure is divided in two. The Main Menu is available for all users and contains all functionality of the system. The Administrator Menu contains all the settings of the system. Enter Administrator Settings from Main Menu - Control Panel. Making changes to the Administrator Settings will change the behavior of the system. The menu structure for Main Menu and Administrator Settings is shown below.

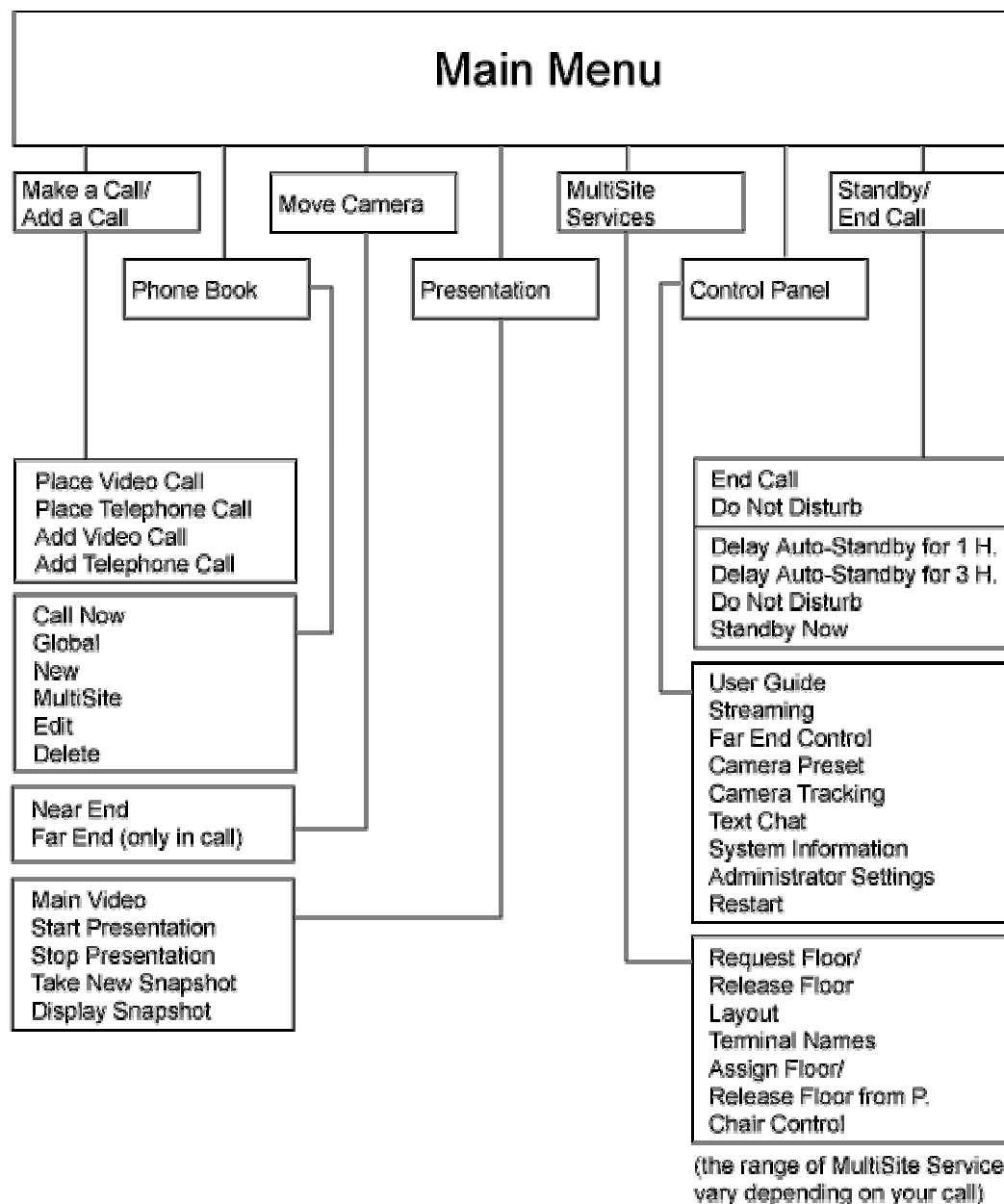

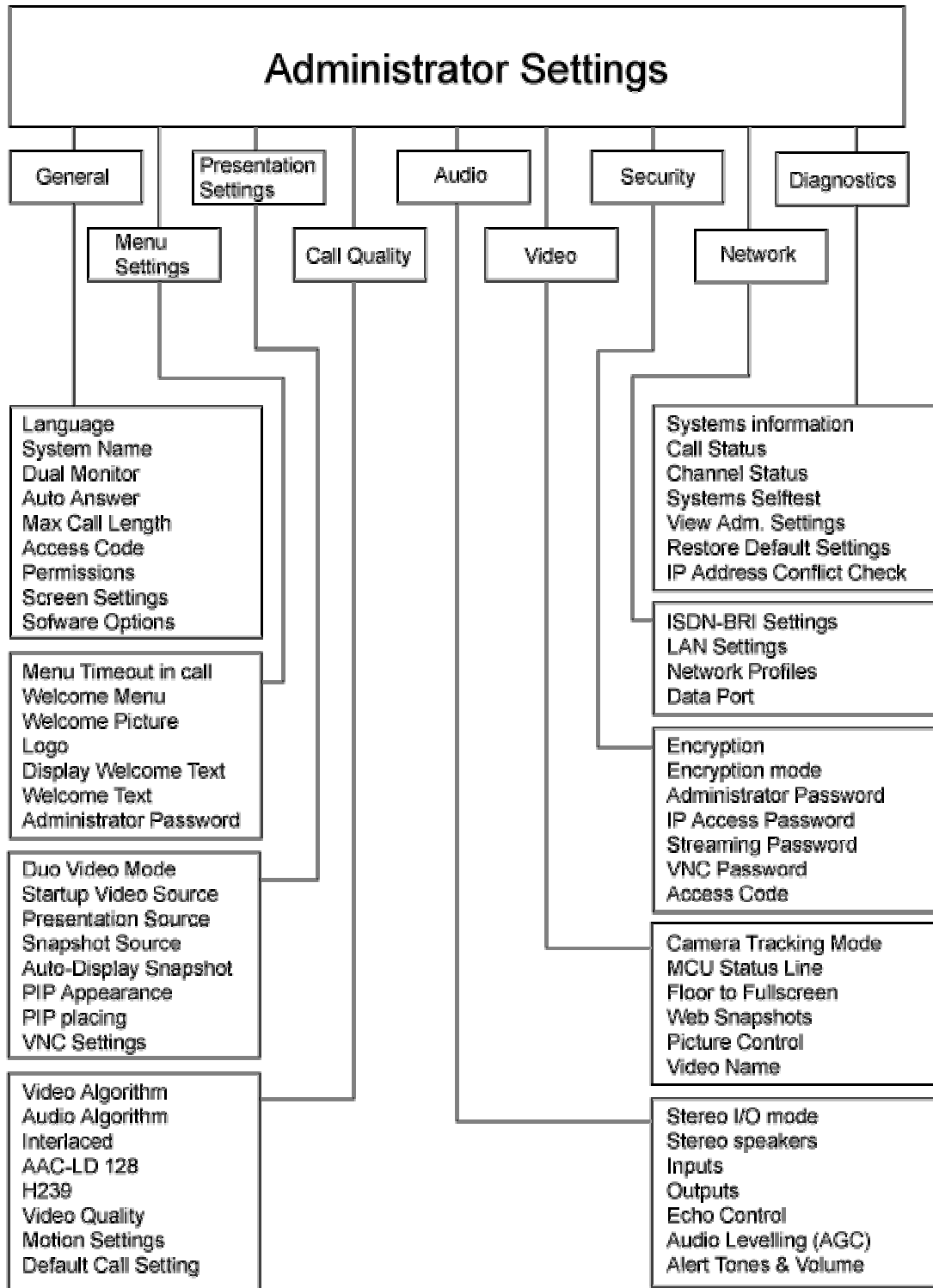

2 Installation

Precautions:

- Never install communication wiring during a lightning storm.
- Never install jacks for communication cables in wet locations unless the jack is specifically designed for wet locations.
- Never touch uninstalled communication wires or terminals unless the telephone line has been disconnected at the network interface.
- Use caution when installing or modifying communication lines.
- Avoid using communication equipment (other than a cordless type) during an electrical storm. There may be a remote risk of electrical shock from lightning.
- Do not use the communication equipment to report a gas leak in the vicinity of the leak.
- Always connect the product to an earthed socket outlet.
- The socket outlet shall be installed near to the equipment and shall be easily accessible.
- Never install cables without first switching the power OFF.
- 1TR6 network type is not approved for connection directly to the telecommunications network. This network type is only to be used behind a PABX.
- This product complies with directives: LVD 73/23/EC, EMC 89/366/EEC, R&TTE 99/5/EEC

2.1 Unpacking and Mounting

Unpacking

To avoid damage to the unit during transportation the system is delivered as separate components:

- Cabinet
- Top plate (when using two monitors)
- High quality monitor (one or two, depending on configuration). XGA monitors are optional.

Inside the cabinet you will find the accessories box which will contain the following:

- W.A.V.E. II Camera
- Table Microphone
- Remote Control
- Documentation

Mounting

- Place the monitor on top of the cabinet/top plate and ensure it is stable.
- You may fasten the monitor to the cabinet using the securing kit.
- Take the camera and remove the plastic backing from the double sided tape-pads on the base of the unit. Place the camera centrally, on top of the monitor close to the front. If the system has two monitors, place the camera on the left monitor (where menus and incoming picture will be displayed).

Note! The camera should be aligned with the front edge of the monitor to ensure that the IR-sensor in the camera can pick up the signals from the remote control.



2.2 Connecting Cables

Connect cables as shown on the figure below:

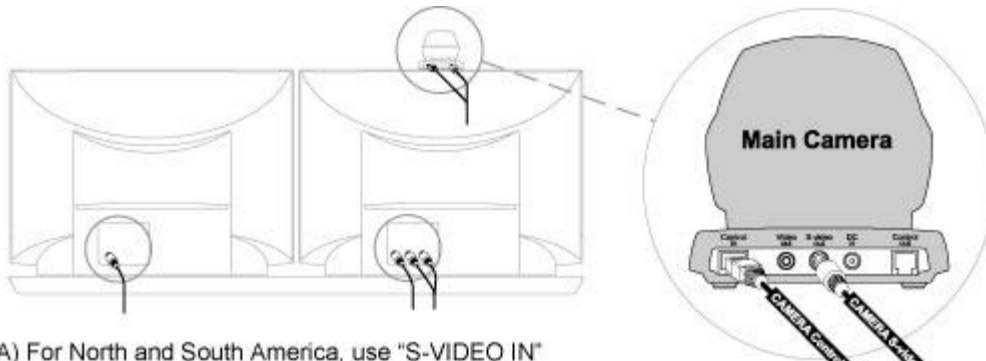

A) For North and South America, use "S-VIDEO IN"

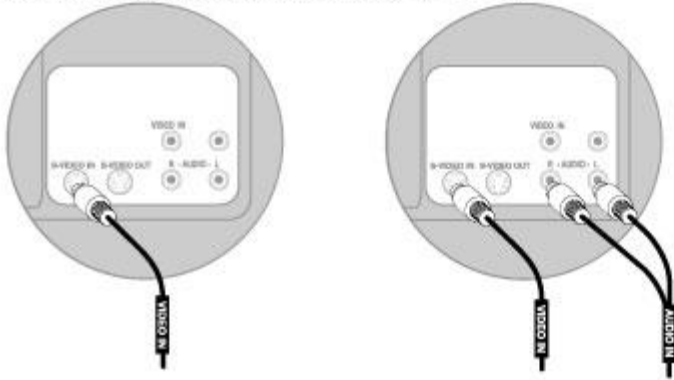

B) For the rest of the world, use "AV1"

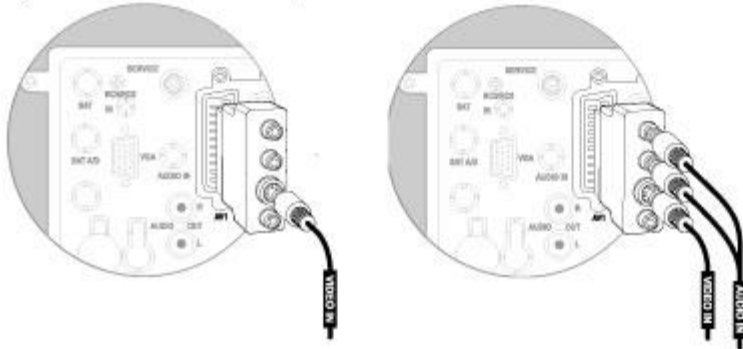

2.3 Monitor Configuration

Power on

Power on the monitor and use the monitor remote control to select the Audio/Video input used (refer to your monitor manual). If you are using S-video from the system, remember to select S-Video input to avoid a black and white picture.

Select Audio/Video input on monitor

Selection of Audio/Video input used is generally performed by pressing the 0/AV button on the TV remote control several times. Please refer to your monitor user manual for further information.

2.4 System Configuration

The system must be configured for each installation. Configuration settings can be made via the system menu.

Navigate through the menu system using the arrow keys and OK. Remember to press the Save button on the bottom of each menu to save your changes. Press Cancel (x) to return to the previous Menu. See next section for more information about how to use the menus and the remote control.

General configuration:

1. Open the General Settings menu

Press OK to open the Main Menu (if it is not already open).

Select Control Panel and then select Administrator Settings. Select General to open the General Settings menu.



2. Language

Press OK in the Language field and select the language you want to use from the list.

3. System Name

Enter a name in the System Name field using the number keys on the remote control, as you would do with a mobile or cellular phone.

4. Dual Monitor

If you are using two monitors, set Dual Monitor to On. If you are using one monitor, set Dual Monitor to Off.

5. Auto Answer, Max Call Length, Access code and Permissions

Leave Auto Answer, Max Call Length, Access code and Permissions unchanged if no special needs are required. See chapter 4.1 General Settings for more information.

6. Screen Settings

When using wide screen (16:9) monitors, set TV Monitor Format to Wide (16:9). TANDBERG also recommends setting Picture Layout to Picture outside Picture when using 16:9 monitors. Picture outside Picture provides a display layout optimized for wide screen monitors. The display layout may be changed at any time using the Layout button on the remote control.

7. Software Options

To activate MultiSite and/or Presenter and bandwidth, you must enter a new option key in the Software Options menu (see paperwork accompanying your system). For more information on these options, contact your TANDBERG representative.

8. Save changes

Remember to save any changes you make in a menu by selecting the Save button on the Menu line and pressing OK.

Network configuration:**1. Open the Network menu**

Open the Administrator Settings menu and choose Network.

**2. ISDN configuration**

Set Current Network to the network you want to use. Specify the settings for the selected network in the relevant menu. For details, follow the instructions in chapter 4.8.1 ISDN-BRI Settings. See also the examples:

- a. Appendix 1: Connecting the system to ISDN using NT1 network adapters
- b. Appendix 2: Connecting the system to the Switched 56 network

3. LAN configuration

In the Administrator Settings menu, choose Network and LAN Settings. Specify the necessary LAN settings according to the instructions from your LAN administrator. For details, follow the instructions in chapter 4.8.2 LAN Settings. If there is an H.323 Gatekeeper present on your LAN, see also chapter 4.8.2.2 H.323 Settings.

4. Save changes

Remember to save any changes you make in a menu by selecting the Save button on the Menu line and pressing OK.

3 General Use

Wake up the system

When the system is not in use, it is in standby mode and the screens are black. Wake up the system by picking up the remote control. An incoming call or pressing any key on the remote will also wake up the system.

If the system does not respond:

- Make sure that the system is switched on by using the On/Off switch located at the rear of the Codec (see figure below).
- Verify that your monitor is switched on. To switch the monitor on you normally push the power button on the front of the monitor (depending on monitor type).



3.1 The Welcome Screen

When the system is switched on, you will see the welcome screen. The welcome screen presents the Main Menu and displays your Main Camera image in the background (Main Camera is system default). Your dial in numbers and system name are displayed in the upper right corner. Your ISDN Number and IP Number are the numbers that your contacts need to place a video call to you.

The welcome screen also provides you with the most important system information:

- System Name
- Your ISDN Number
- Your IP Address/IP Number

It is possible to customize the text on the welcome screen. See chapter 4.2 Menu Settings for how to edit welcome text.



3.2 Using the Remote Control

The system is controlled with a remote control. Think of the remote control as a mobile phone with number keys and call keys. Use the arrow keys and OK to navigate the menu. The system's most commonly used functions are also accessible directly from the remote control.

The Infra Red (IR) sensor for the remote control is located in front of the WAVE II Camera. There is also a second IR-sensor located in the front of the Codec itself, which will be automatically enabled if the WAVE II Camera is not connected.

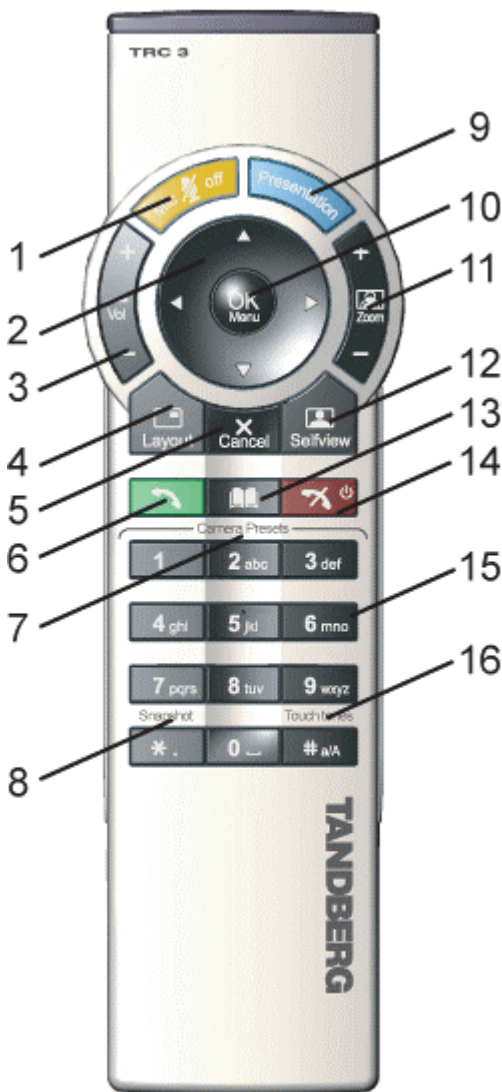

1. Mic Off turns your microphone on and off.
2. Arrow keys are used for navigation in the menu and for moving the camera when the menu is hidden.
3. Volume + and – adjusts the system volume.
4. The Layout key toggles between full screen and different display layouts.
5. Cancel takes you back one step in the menu system. Use Cancel to delete characters in an input field.
6. Press the Call key to place a call.
7. Camera presets define specific camera positions. Press and hold a number key for 1 second to save the current camera position to that number key. To activate a preset whilst in a call, simply press and release that number key.
8. Snapshot takes a snapshot of your video. (Only while you are in a call)
9. The Presentation key switches to a predefined presentation source.
10. Press OK/Menu to show the menu and to select menu items.
11. Use Zoom + and – to zoom the camera in and out.
12. Selfview displays your outgoing video. Press Selfview again to turn selfview off.
13. Store and recall your video contacts via the system Phone Book for easy placement of calls.
14. Use the red End Call key to end the current call. Pressing this key when not in a call will place the system in Standby mode.
15. Number/Letter keys function in the same manner as with a mobile or cellular phone.
16. Press Touch tones when you are in a call and need to dial extension numbers etc. (instead of presets).

3.2.1 Navigation



Arrow keys and OK

Navigate in the menu with arrow keys. The yellow selector on screen shows the selected item. Press OK to select.



Cancel key

In the main menu, pressing Cancel (X) will hide the menu. If the menu is hidden, bring it back with OK. In other menus, pressing Cancel (X) takes you one step back. In an input field, pressing Cancel (X) will delete characters/numbers to the left.



Back/Cancel button

The X button in the menu corresponds with the X key on the remote.

3.2.2 Selfview

Selfview shows your outgoing picture. Normally this is the picture of your self (main camera). Selfview is most useful for single monitor systems. On dual monitor systems you already have selfview on the dual monitor. In a normal conference, the far end side is displayed on main monitor. Pressing Selfview will result in near end on main monitor. Outside a call, selfview is already displayed on the screens. Pressing selfview will result in a black screen. Press selfview again to bring the picture back.

How to use Selfview:

1. Press Selfview once to see a full screen picture of yourself (your outgoing video).
2. Press Selfview again to turn selfview off and go back to normal.

3.2.3 Layout

The Layout button has two behaviors depending on the Picture Layout setting in Administrator Settings (see chapter 4.1.8 Screen Settings). It can provide either a Picture in Picture or a Picture outside Picture.

3.2.3.1 Picture in Picture

With Picture in Picture (PIP), Layout makes it possible to see an extra picture in a smaller view. Pressing Layout will bring up a picture in picture in the corner of the screen. Press Layout again to move it to the other corners of the screen and finally hide it. You can also hide it directly by pressing and holding Layout for 1 second. Picture in picture will always appear on the main monitor. Automatic PIP is the system's default setting. That means that you will automatically show Picture in Picture when it is suitable (see chapter 4.3 Presentation Settings).

How to use Layout with Picture in Picture:

1. Press Layout once to bring up a picture in picture.
2. Press Layout three more times to move it around in the corners of the screen.
3. The fourth time you press Layout, it will disappear.
4. Pressing and holding Layout for 1 second will hide the small picture directly from any position.

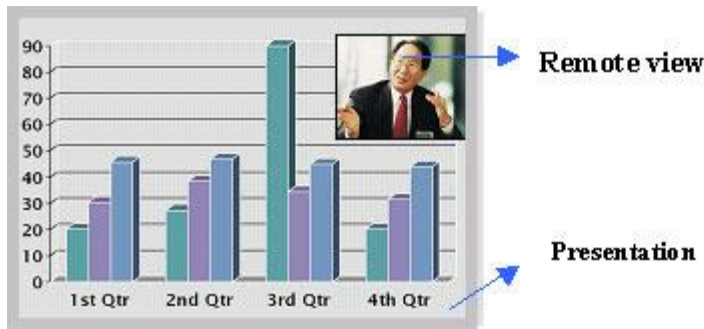

Example of PIP

3.2.3.2 Picture outside Picture

With Picture outside Picture (POP), pressing Layout will bring up compositions of the pictures that are optimized for wide screens. Press once to get an extra picture in a smaller view. Press twice to get side-by-side view. Press again to go back to full screen view. You can also go back to full screen directly by pressing and holding Layout for 1 second. It is recommended to use Picture outside Picture for wide screen monitor systems.

How to use Layout (Picture outside Picture):

1. Press Layout once to get the 1+3 layout. You see a big far end picture and a smaller picture of yourself in the upper right corner. If you use Duo Video, you see a big picture of the far end and small pictures of the far end and yourself.
2. Press Layout again to get the side-by-side layout (1+1). You see two equally big images of the far end and yourself.
3. The third time you press Layout you go back to normal full screen view.
4. Pressing and holding Layout for 1 second will bring you back to full screen anytime.

Note that if both TV monitor format and VGA format (in Administrator Settings - General - Screen Settings) is set to Normal, the system will skip the 1+3 layout, which is not beneficial for 4:3 monitors.

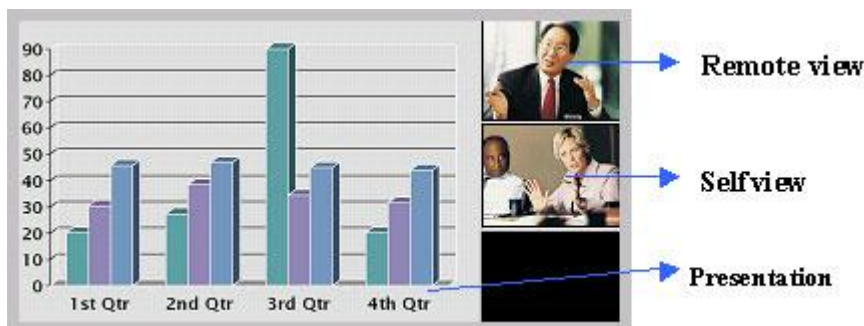

Example of POP

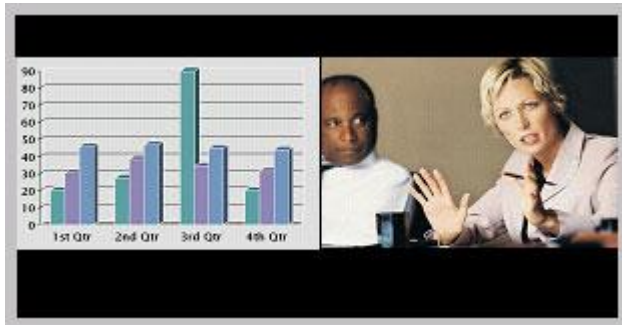

Example of Side by Side

3.2.4 Mic Off

To mute your microphone during a call, press Mic off. An on-screen indicator appears when the microphone is off. In a call, if audio is detected, the on-screen symbol will start to flash. Pressing Mic off one more time will activate the microphone again.

Mic off will mute microphone inputs, but will not mute audio from the AUX and VCR inputs.

Be aware that many calls are connected automatically with Mic off, because the Auto Answer settings are On+Mic off (see chapter 4.1.4 Auto Answer). The icon will start to flash when you start speaking. Remember to turn the microphone on before a meeting.

3.2.5 Volume + and -

Press the Volume key to adjust the volume level. An on-screen indicator will show the current level.

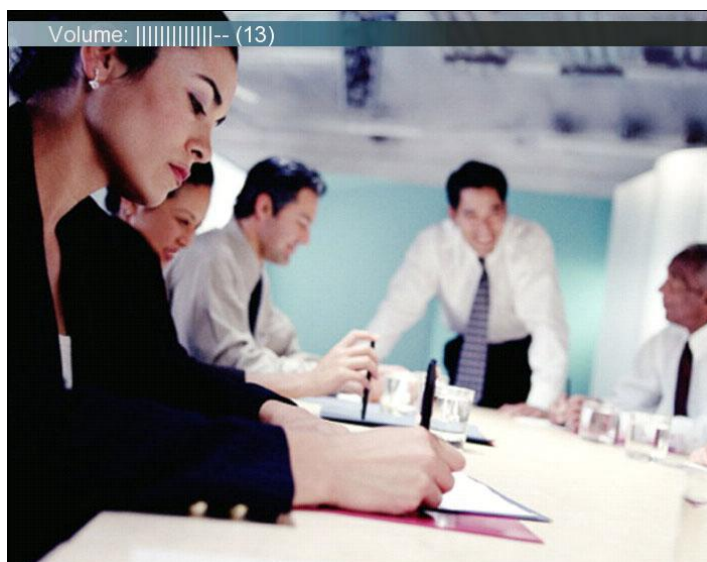

3.2.6 Number and Letter keys

Pressing a number key when you are outside a call will take you to the call menu. When you are in a call, the number keys are used for Camera Presets. Press a number and you go to the corresponding Camera Preset (see chapter 3.10.3 Camera Presets). However, when you are in an input field where numbers are required, the system automatically goes to number mode and you can dial numbers with the number keys as usual.

When you are in an input field where letters are required, the system automatically goes to letter mode. Writing letters works like on a mobile phone. Press the key that corresponds to your desired letter. Press the key as many times as you need to get the right letter. Change to lower or back to upper case letters with the a/A key, and space with the 0 _ key.

To write numbers in a text input field, press the button through all the letters. Press once more and the number will appear.

Example: How do I write "System 123" in the System Name input field (in General in Administrator Settings)?

Press the 7-key four times to get an "S".
Press the #-key once to switch between upper case and lower case letters.
Press the 9-key three times to get a "y".
Press the 7-key four times to get an "s".
Press the 8-key once to get a "t".
Press the 3-key twice to get an "e".
Press the 6-key once to get an "m".
Press the 0-key once to get space.
Press the 1-key three times to get a "1".
Press the 2-key four times to get a "2".
Press the 3-key four times to get a "3".

3.2.7 Touch Tones

Sometimes you need to dial extension numbers with the number keys when you are in a call. Pressing numbers will result in a camera preset. In these cases, press # to enable Touch tones. An indicator will tell that touch tones are enabled. Now you can enter your extension number with the number keys. Finish with OK to exit Touch tones mode.

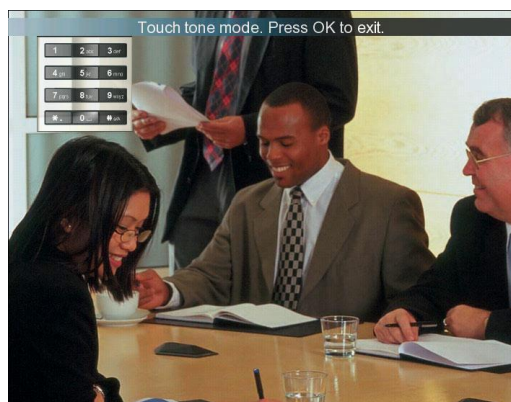

3.3 On Screen Indicators

The system has a number of icons signaling different settings:

**Volume Off**

This indicator is shown when the volume is turned off. Press Volume + to turn the volume back on.

**Microphone Off**

This indicator is shown when the microphone is turned off. The indicator will start to flash if audio is detected in the room during a call and the microphone is turned off. Press the Mic off button again to turn the microphone back on.

**Secure Conference, AES**

This double padlock indicator is shown when AES encryption (Secure Conference) is active.

**Secure Conference, DES**

This padlock indicator is shown when DES encryption (Secure Conference) is active.

**Not Secure Conference**

This open padlock indicator is shown during the initialization phase for encryption. During this period the call is not secure.

**Floor**

This indicator is shown when you are displayed in full screen in a multipoint conference.

3.4 Using the Menu



Main menu outside a call and in a call.



The menu is the Interface you will use to control the system. The main menu contains: Make a Call, Standby, Phone Book, Move Camera, Presentation, MultiSite Services and Control Panel. When you are in a call, Add another Call and End Call will be available via the green and red buttons. (See pictures below)

The menu automatically times out after 15 seconds (see chapter 4.2.1 Menu timeout). Press OK/Menu to bring it back. You can also hide the menu manually by pressing Cancel (X) in the main menu.

The main menu contains the following items:

- Make a Call/Add Another Call
- Standby/End Call
- Phone Book
- Move Camera
- Presentation
- MultiSite Services
- Control Panel

3.5 Make a Call

To make a call, choose Make a Call from the main menu. If you are already in a call, choose Add another Call from the main menu to call another participant (if your system has MultiSite capabilities). Pressing the green key on the remote has the same effect as pressing the green button in the menu. You can enter a number manually in the input field or select the book icon to select a contact from the phone book.

The TANDBERG system can make both video calls and telephone calls. For video calls, choose Place Video Call in the call menu. For telephone calls, choose Place Telephone Call. Call Settings specifies the quality of the call. In most cases you can leave call settings unchanged.

If your TANDBERG system has MultiSite capabilities, you can call several participants at the same time. Choose Add Video Call or Add Telephone Call in the call menu and more dial fields will appear.

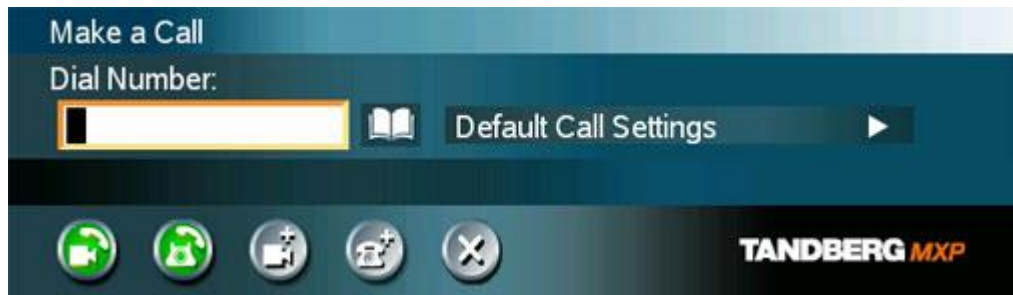

Choose among the buttons:

- Make Video Call
- Make Telephone Call
- Add Video Call/Add Telephone Call
- Call Settings

3.5.1 Video Call

It is very easy to make a Call. Think of a mobile phone; -Choose Make a Call, dial a video number or a telephone number and hit the green key.

How to make a video call:

1. Press the green key on the remote or choose Make a Call from the Main Menu to open the Call menu.
2. Dial a video number with the number keys (use a star as separator in IP addresses).
3. Press the green key on the remote or move the yellow selector down to the Place Video Call icon and press OK to start the video call.



3.5.2 Telephone Call

The TANDBERG system has great audio- as well as video performance. Use the system both as a videophone and a telephone!

How to make a telephone call:

1. Press the green key on the remote or choose Make a Call from the Main Menu to open the Call menu.
2. Dial a telephone number with the number keys.
3. Move the yellow selector down to the Place Telephone Call icon and press OK to start the telephone call.

When you dial a telephone number and press the green key on the remote, the system will in most cases automatically interpret the number as a telephone number and not a video number. The interpretation can sometimes take a little while. If you want to make a telephone call in a quicker way, it is recommended to use the Place Telephone Call button in the menu.

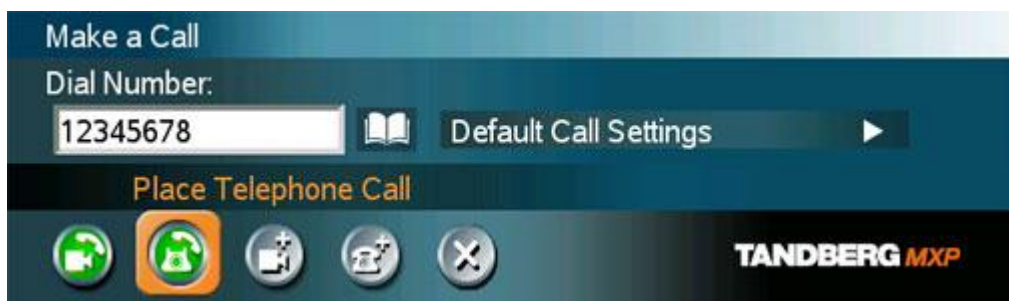

3.5.3 Add Call

(optional feature)

TANDBERG system's built-in MultiSite can handle 4 video calls and 3 telephone calls including yourself. With the Add Call buttons it is possible to connect to several participants simultaneously, avoiding dialing each participant one by one, which can be time consuming. Press Add Call to get the desired amount of participants to your MultiSite call.

How to use Add Call:

1. Press the green key on the remote or choose Make a Call from the Main Menu to open the Call Menu.

2. Choose Add Video Call or Add Telephone Call from the menu line. An extra number field appears. Press the Add button until you have the desired number of participants (press Cancel inside an empty input field to delete the field).
3. Dial Numbers with the number keys.
4. Press Make Video Call to start the videoconference. If you have a mixed conference with both video and telephone participants, press Make Video Call. Press the Make Telephone Call if you want to start a conference with telephones only.



3.5.4 Call Settings

The field on the right in the call menu displays Call Settings. Call Settings gives you the opportunity to specify Call Type, Network, Bandwidth and Restrict (56k).

How to use Call Settings:

1. Press Make a Call to open the Call menu
2. Move the selector to the Call Settings field on the right of the call menu and press OK.
3. Make desired changes to Call Type, Network, Bandwidth and Restrict (56k).
4. Press OK to save. The new call settings will be displayed in the Call settings field.



Call Type	Call Type can be set to Video Call (default) or Telephone Call. Using Video, the system will try to connect as a video call. Some network configurations will cause the fallback to a telephone call to fail. In these cases, you should set the call type to telephone and the call will be placed as a telephone type only. For MultiSite calls, Call Type enables you to specify both telephone calls and video calls in the same conference.
Network	<p>The Network alternatives are: Auto, ISDN and H.323 (LAN). The system will, by default, try to connect using Auto Network. That means that the system will automatically use the right network depending on the number you have dialed.</p> <p>If Auto is selected, the system will select a network based upon the following criteria:</p> <ul style="list-style-type: none"> ▪ If an IP-address (e.g. 10.12.34.56) is entered, H.323 (LAN) is selected. ▪ If the first digits in the number match those set in H.323 Prefix under H.323 Settings, LAN is selected. ▪ In other cases, ISDN (H.320) is selected. <p>If you need to ensure that you make an H.323 or ISDN call, specify this by choosing H.323 or ISDN. ISDN indicates ISDN-BRI, ISDN-PRI, Leased E1/T1 and External Networks. If a gatekeeper is present, you may place IP-calls using “telephone-style” numbers (an E.164 alias), according to the numbering plan implemented in the gatekeeper. The gatekeeper will then translate the dialed number into an IP-address (see chapter 4.8.2.2 H.323 Settings for more information about gatekeepers).</p>
Bandwidth	<p>Bandwidth decides the quality of the video picture. The system will, by default, connect using Auto Bandwidth. This means that the system will establish a connection using a proper bandwidth for your call. If a call is added or dropped during a meeting, the call will automatically maintain the optimal connection without interrupting the call in progress. This is called <i>downspeeding</i>. The system regulates the bandwidth according to how many calls that are in the conference.</p> <p>The typical bandwidths used for ISDN and IP calls are 384kbps and 768kbps respectively. When bandwidth is set to auto, the unit will default to 384kbps for ISDN calls and 768kbps for IP calls. When downspeeding is enabled, the system will automatically adjust to a lower speed if the receiver can not handle the default bandwidth. See table below for more information about the different bandwidths.</p>
Restrict (56k)	A restricted call is a call that uses 56kbps channels rather than the default unrestricted 64kbps channels. Some older networks (primarily in the USA) do not support 64kbps channels and require the use of restricted 56kbps calls. By default the system will dial an unrestricted call and downspeed to 56kbps if necessary. To force a restricted call, choose Restrict (56k) On. An indicator “(56k)” will be shown beside the number.
Use Set as Default	If you want to change the default Call Settings, make the desired changes to the Call Settings and Press Set as Default. Press OK to Save. These settings will now be the default settings for all future manually dialed calls.

Type of calls*

Auto: 384 kbps on ISDN/768 kbps on LAN
 Max: 512 kbps on ISDN-BRI
 2Mbps (1920 kbps, IP only)

1472 kbps = 23B, IP only
 1152 kbps = 18B, IP only
 768 kbps = 12B, IP only
 512 kbps = 8B
 384 kbps = 6B
 320 kbps = 5B
 256 kbps = 4B
 192 kbps = 3B
 128 kbps = 2B, Bonding/H.221
 64 kbps = 1B, H.221

*Some software versions and networks do not support all channel selections.

H.221 or 2x64 (2x56) Calling

Some older or low end video systems do not have the ability to make bonded ISDN calls. In these cases you may have to dial both ISDN numbers separately to call those systems. These types of calls are often referred to as H.221 calls, 2x64 calls, or 2x56 calls, as you are making 2 x 64 kbps or 2 x 56 kbps calls to the same system. To place this type of call, set bandwidth to 128 kbps and Network to ISDN. A field for 2nd number pops up in Call Settings. Enter the first number in the call menu and the second number in the Call Settings field. For 128 kbps calls that use bonding, ignore the second number field and just enter one number to be dialed.

Using sub-address / extension address / MCU password

Sub-address is used to address different systems on the same ISDN line and is primarily used in European Countries. TCS-4 is used to address different systems on a LAN, when dialing in via a gateway.

To specify an ISDN sub-address or its LAN equivalent extension address (TCS-4), add a star (*) after the number and then enter the sub-address/extension address.

Example:

12345678*10 (<number>* <Sub-address/extension address/MCU password>)

When calling to external MCU's requiring a password (TSC-1), this password can be added after the star (*). If no password is specified, a menu will prompt you to enter the password (after connecting to the MCU).

3.6 Answer an incoming Call

You can receive calls anytime, even when the system is in standby mode. But remember to switch the system on using the On/Off switch located at the rear of the system as described in chapter 3 General Use.

How to answer an incoming call:

1. To accept an incoming call, press OK or the green key on the remote control.
2. Press the red key on the remote control to reject the incoming call.
3. If you do not want any incoming calls, choose Do Not Disturb. If Do Not Disturb is on, the system will automatically reject all incoming calls. See Chapter 3.8.3 Do Not Disturb for further details.



If Auto Answer is set to On, an incoming call will connect automatically. You can set Auto Answer On, On + Mic Off or Off in Administrator Settings\General Settings, see chapter 4.1.4 Autoanswer.

3.7 End Call

The remote control works much like a mobile/cellular phone. Press End Call from the main menu or the red key on the remote control. In the End Call dialog box, press End Call again. Press Cancel (x) to continue the call.

How to end a call:

1. Press the red key on the remote control or End Call from the main menu.
2. Press the red key on the remote control again or OK to confirm that you want to end the call.

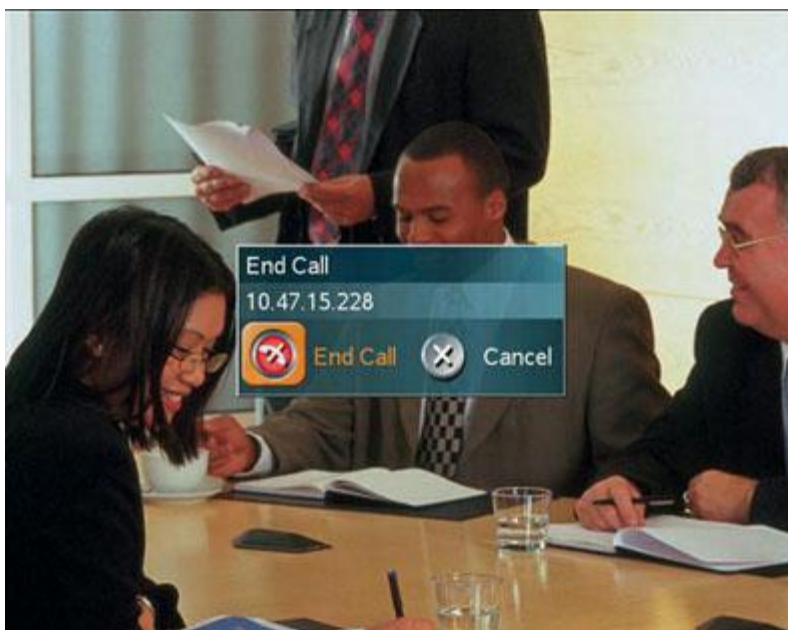

How to end a multipoint call:

1. Press the red key on the remote control or End Call from the main menu.
2. A list of participants appears allowing you to end each separate call. Select a participant and press OK or the red key.
3. Press End All Calls if you want to end the whole conference.

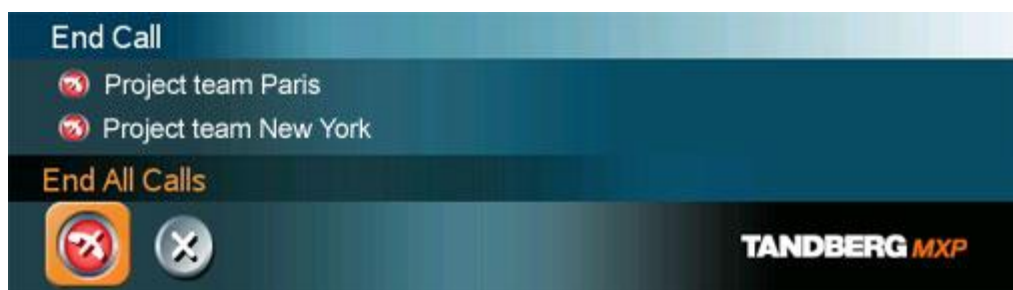

Note that switching off the monitor(s) will not end a call. To end a call you must press the red key.

3.8 Standby

The system will automatically go to Standby mode when it is not in use. You can also choose Standby from the main menu (outside a call) to put the system to standby. In standby mode, the screen(s) are black. It is however still possible to receive incoming calls.

The monitors should always remain powered on and the stand-by mode of the system should be used if the system is to be left idle.

Note! You will not turn your system to standby by switching off the monitors.

How to use standby mode:

1. Press the red key on the remote control or choose Standby from the main menu when you are outside a call.
2. Press the red key again or choose Standby Now from the Standby menu.
3. The screen(s) turns black.
4. To wake up the system again, pick up the remote control, or press any of its keys.

3.8.1 Delay Auto-Standby for 1 hour

Delay Standby for 1 hour postpones the automatic standby mode for 1 hour. Use Delay 1 hour if you want to prevent the system from going to standby automatically. This is useful if you want to use the monitors for a local presentation and prevent the system from automatically blanking out the monitors because the video system itself is idle.

3.8.2 Delay Auto-Standby for 3 hours

Delay Standby for 3 hours postpones the automatic standby mode for 3 hours.

3.8.3 Do Not Disturb

Do Not Disturb means that the system will not accept any incoming calls. The caller will hear a busy tone when calling this unit. An indicator will indicate when Do Not Disturb is active.

End Do Not Disturb by pressing any key on the remote control. The indicator will disappear.

3.9 Phone Book

The local Phone Book stores up to 200 contacts including the last numbers dialed. Using the Phone Book is time saving and makes sure you do not inadvertently call the wrong number.

The contacts are sorted alphabetically. Navigate the phone book with arrow keys or letter keys, searching on the first letter (like on a mobile/cellular phone). Press arrow to the left to select a button. You will see that the last selected contact will be marked. An arrow beside a contact indicates that this is a MultiSite. The first entry, Last Numbers Dialed, lists your latest calls. Press arrow key right to see the list.

How to make a call using the phone book:

1. Open the Phone Book from the main menu or press the Phone Book key on the remote.
2. Find your desired contact using the arrow keys or searching on the first letter with the letter keys.
3. Press the green call key on the remote or press arrow key left to select the Call Now icon. Press OK. Alternatively, press OK to select the contact. You will go to the Call menu, where you may edit the number or call settings before you place the call.
4. Wait for the call to connect.

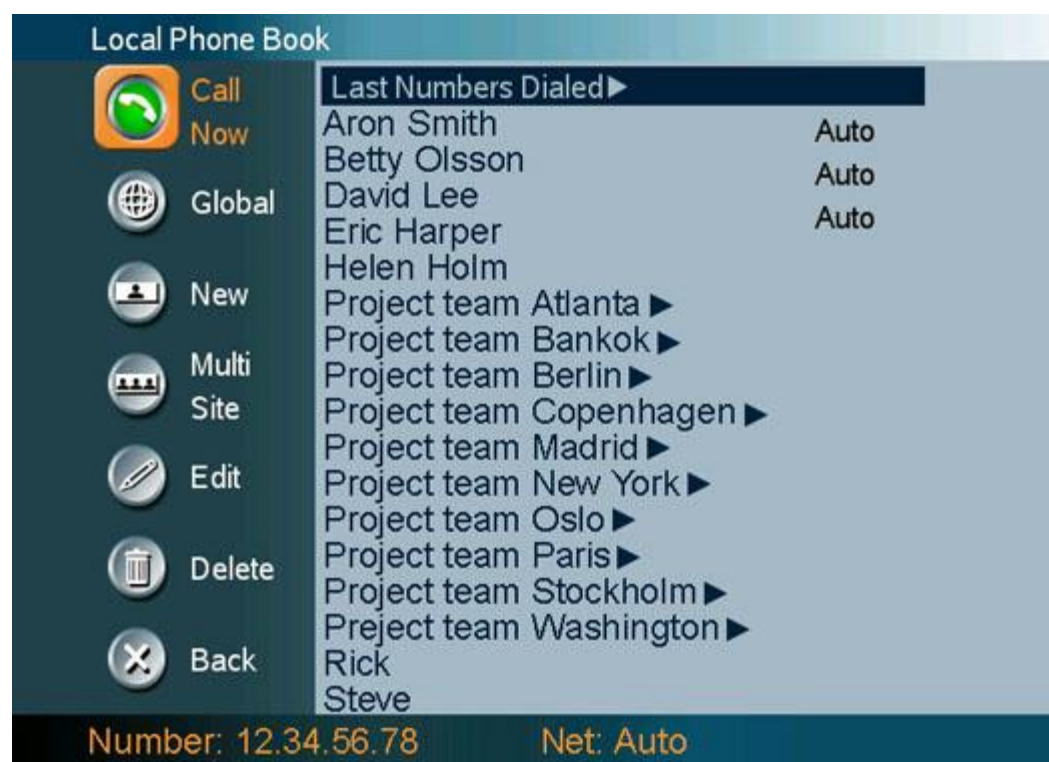

Note that the number of the selected contact is displayed at the bottom line.

3.9.1 Global Phone Book

If your system is connected to an external management system like the TANDBERG Management Suite (TMS), it is possible to use a central contact list from the management system. These contacts can not be changed locally by the system, only from the management system. If you need to modify a number before dialing it, you can do so by hitting ok after selecting the entry, and modifying the number before placing the call. The changes are not saved in the contact.

For contacts you use often, you may consider copying them from the Global Phone Book to your Local Phone Book. This makes them easier to find if your Global Phone Book is large, but the local copy would not be updated if the Global Phone Book contact is changed.

How to copy a contact from the Global Phone Book to the Local Phone Book:

1. Move the yellow selector down to the desired contact in the global phone book.
2. Press arrow key left, select the Copy to Local button and press OK.
3. The contact is copied to your local phone book.

3.9.2 New

Select the New button to make a new contact. You can store up to 200 contacts in your local phone book. To make a new contact, you must specify a Name and Number. Use the number and letter keys on the remote control (in the Name field you will automatically write letters, in the number field you will automatically write numbers). Call Type, Network, Bandwidth and Restrict (56k) are put to default if you don't make changes. Press OK to save.

For bandwidth 2x64 kbps or 2x56 kbps, two numbers are required. Two number fields appear and both numbers must be specified (see also Calling with two ISDN lines in chapter 3.5.4 Call Settings).



3.9.3 MultiSite

(optional feature)

It is possible to pre-define MultiSite meetings using the phone book. You can have up to 6 video participants (including yourself) and 5 telephone participants in a meeting. All sites will then be connected automatically instead of having to add sites one by one. You can store up to 50 MultiSites in the phone book. MultiSite entries consist of contacts that are already stored in the phone book. When making a new MultiSite entry, begin with saving all participants one by one.

How to make a MultiSite entry:

1. Open Phone Book from the menu or from the remote control. Choose MultiSite.
2. Enter a name.
3. Press Add Participants. Pick a contact from the list and press OK.
4. Repeat 3. until you have the desired selection of participants.
5. Press OK to save.



Bandwidth for a MultiSite entry

A MultiSite entry will add the bandwidths from all the participants and try to connect. If this bandwidth exceeds your systems maximum bandwidth, the system will downspeed and distribute the available bandwidth equally on the participants.

Example: In a multipoint entry there is one participant with bandwidth 256 kbps and one participant with bandwidth 384 kbps. You have 512 kbps as your maximum bandwidth.

The two participants' bandwidth exceeds your maximum bandwidth. The system will downspeed so that each participant connects with equal bandwidth $512 \text{ kbps} / 2 = 256 \text{ kbps}$

3.9.4 Edit

To edit a contact, highlight the contact and press arrow left. Press arrow key down to select the Edit button. In the edit window you can edit Name, Call Type, Number, Network, Bandwidth and Restrict (56k). Press OK to save.

When you edit a contact that is part of a MultiSite entry, the contact will be updated in the MultiSite entry automatically.



3.9.5 Delete

To delete a contact, highlight the contact and press arrow left. Press arrow key down to select the Delete button and press OK. Confirm by pressing OK again.

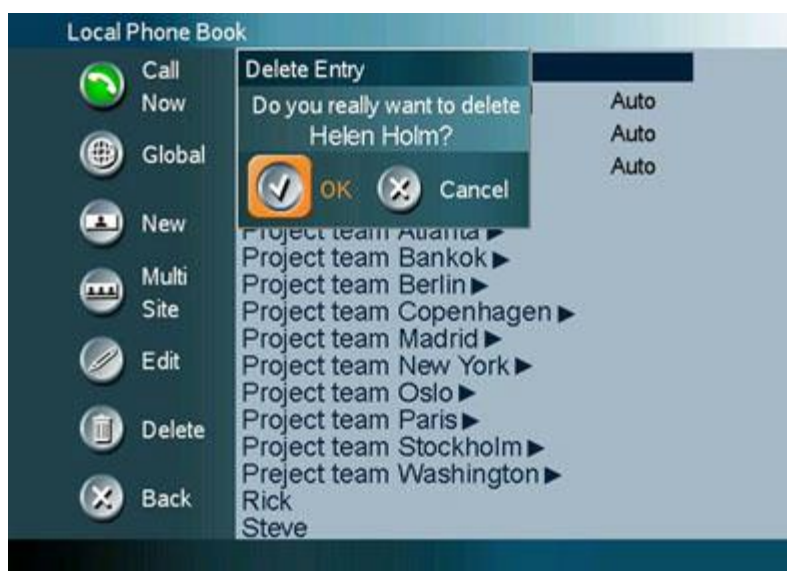

3.10 Move Camera

There are several ways to move the camera:

- Choose Move Camera from the main menu. Use the arrow keys to pan and tilt the camera. Press OK when done.
- When the menu is hidden, the arrow keys will work on the camera. Hide the menu with the Cancel (X) key and adjust the camera with the arrow keys.
- Use Camera Presets. Press a number and the camera will move to a predefined position (when you are in a call). See chapter 3.10.3 Camera Presets.
- Use Automatic Camera Tracking. See chapter 3.13.5 Automatic Camera Tracking.
- Use the TANDBERG tracker (see separate documentation).

3.10.1 Zoom

The zoom key on the remote control will zoom the picture in and out (+ and -).

3.10.2 Far End Camera Control

When you are in a call, you can also move the far end camera (if the far end side supports H.281, Far End Camera Control). Choose Move Camera from the Main Menu. A dialog box offers you the options: Near End and Far End. Near End means your own camera. Far End means the far end's camera. Choose Far End to move the Far End camera.

How to use Far End Camera Control:

1. Choose Move Camera from the Main Menu when you are in a call.
2. Choose Far End.
3. Move the far end camera with arrow keys and zoom.
4. Press OK when done to escape far end camera control mode.

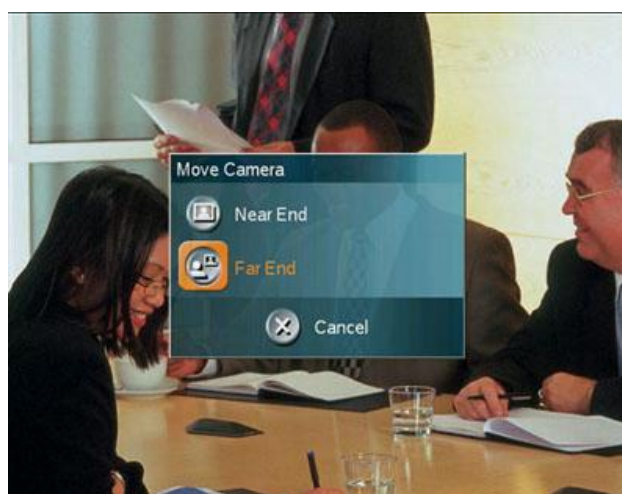

Example: You cannot see what the far end is writing on their whiteboard.

Choose Move Camera from the main menu. Choose Far End from the dialog box. Use Zoom and arrow keys to move the far end camera. Press OK when done to go back to normal.

See also 3.13.3 Far End Control for more about Far End Control functionality.

3.10.3 Camera Presets

Use Camera Presets to easily vary between specific camera positions. When you are in a call, presets are available directly on the number keys on the remote control. Press a number to activate a Camera Preset. You can save presets 1-9 presets by the corresponding number for 1 second. Note that Camera Presets does not work when you are in an input field (then you need the numbers for dialing). Camera Presets are also available from the Camera Presets menu under Control Panel.

Each Camera Preset is able to store:

- Main Camera position (pan, tilt, zoom).
- Video source.
- Audio source selection (see chapter 4.5 Audio for further details).

How to use Camera Presets:

1. When you are in a call, press a number on the remote control. The camera will move to the corresponding position (or video source).
2. Alternatively, open the Presets menu in Control Panel. Choose Display Presets and select a preset with arrow keys and OK.
3. Presets are deactivated when you move the camera manually with the arrow keys.

How to save a new Preset:

1. Position the camera in the desired position.
2. Press a number for 1 second to save the corresponding preset.
3. Alternatively, open the Presets menu in Control Panel. Choose Save New Preset. You can save 15 presets on numbers 0-14. Enter a number (0-14) and press Save. The new Preset will overwrite an existing preset.

Example: In your office you have a white board, your PC and a small meeting table. Use Presets to move between these camera positions.

Use Camera Presets to quickly and precisely change camera positions and video sources between these three targets. Position the camera to the white board and save it as preset 1 (save a preset by pressing the number key for 1 second). Press the Presentation key to open a PC presentation and save this as preset 2. Position the camera to meeting table and save it as preset 3. When you are in a video call, use the numbers 1, 2 and 3 to activate these presets.

Saving Presets for the TANDBERG Tracker: (see separate TANDBERG Tracker instructions included with the tracker):

1. Select which Camera Preset to be used on the TANDBERG Tracker.
2. Move the camera to the position you want to save on the tracker.
3. Save Camera Presets 10-14 from the Save Camera Preset menu (as described in 3 above). It is not possible to save presets 10-14 directly from the remote control.
4. Press the single button on the tracker to activate the Camera Preset.

3.11 Presentation

The Presentation Functionality in the system enables you to show PC, Document Camera, VCR, AUX and VNC in addition to your Main Camera. This is perfect for meetings where you would like to show a PowerPoint presentation for instance. You can even use arrow keys up and down on the remote control to activate Page Up/Down on the PC (this only applies when using VNC).

Use Presentation outside a call to make a local presentation for the people in your own meeting room. Use Presentation when you are in a call to make a presentation for the far end as well.

The quickest way to show a presentation is to use the presentation key on the remote control. The presentation key shows a predefined video source, PC is the default. It is possible to change the presentation source in Presentations Settings in the Administrator Settings menu. (See chapter 3.11.1 Presentation Key).

Choose Presentation from the main menu if you want to select a video source manually. The Presentation menu offers you all available video sources; Main Camera, PC, Document Camera, VCR, AUX and VNC. (See chapter 3.11.2 Presentation Menu).



3.11.1 Presentation Key

The quickest way to show a presentation is to use the presentation key on the remote control. The presentation key shows one predefined video source, PC is the default presentation source. It is possible to change default presentation source in Presentation Settings, see chapter 4.3 Presentation Settings for more information.

How to show and end a Presentation using the Presentation key:

1. Remember to connect your PC to the codec (see chapter 3.11.3 PC Presenter).
2. Press the Presentation key. PC is displayed in full screen.
3. Press the Presentation key again to end the presentation and go back to main camera.

3.11.2 Presentation Menu

The Presentation menu offers you all available video sources; Main Camera, PC, Document Camera, VCR, AUX and VNC. All these sources can be used as Main Video or Presentation (Duo Video). Press the Main Video button to change Main Video, press the Presentation button to choose Presentation Video.



How to change your main video source:

1. Choose Main Video from the Presentation menu.
2. In the Main Video dialog box, choose your desired video source and press OK.



How to show a PC presentation in addition to your main video (Duo Video):

1. Remember to connect your PC to the codec (see chapter 3.11.3 PC Presenter).
2. Choose Start Presentation from the presentation menu.
3. In the Presentation dialog box, choose a presentation source and press OK.

Note that Start Presentation is only available when you are in a call and the video systems support Duo Video or H.329.



How to stop a Presentation (Duo Video):

1. Choose Stop Presentation from the Presentation menu.
2. Press OK to stop the presentation.



3.11.3 PC Presenter (DVI/XGA Input)

(Optional feature)

Users often have their presentations on a laptop that is brought into the meeting room. Remember to connect your PC to the codec before you press the Presentation button. Note that the image will appear smoother on the system if your presentation is already displaying in full screen on your PC prior to connecting your PC to the video system.

Plugging a PC into the system is made extremely simple through the PC Presenter, avoiding the need for any additional hardware such as a projector, PC/Video converter or extra cables.

How to connect PC to the codec with the DVI/VGA cable:

1. Connect the VGA-DVI cable to the PC Presenter (PC DVI-I in) connector on the codec.
2. Connect the VGA-DVI cable to your PC (VGA Output).
3. When the PC is connected to the codec, hit the Presentation key to display the PC image on the system.



If no PC image is displayed on your monitor, make sure that your PC is set to activate your VGA output. On most laptop PCs you must press a special key combination to switch the PC image from the PC screen to the video screen.

Note that the DVI/VGA input is compliant with VESA Extended Display Identification Data (EDID) and will be able to reconfigure the PC's screen settings if it is currently configured to a VGA format that the system doesn't support (see 5.12 EDID)

VGA-formats supported on 'DVI-I in'. (VESA compliant)

SVGA	800X600	60,72,75,85 Hz
XGA	1024X768	60,70,75 Hz
SXGA	1280x1024	60Hz

3.11.4 PC Soft Presenter and VNC

(Optional feature)

PC SoftPresenter is used to display PC images on your system without using a VGA cable (PC Presenter). The system and your PC must be connected to the same LAN. In addition, VNC (Virtual Network Computing) server software must be installed on the PC. Free software can be downloaded from <http://www.realvnc.com>. Install the software by running the downloaded file.

How to configure the VNC Server software:

1. Select the following to setup VNC; Windows-Start\All Programs\Highlight RealVNC\Highlight VNC Server>Show User Properties
2. Select Accept Socket Connections.
3. Select Auto for Display Number. Display Number in the system must then have the value 0.
4. Enter a password in the Password-field. This must correspond with the VNC Settings on your system.

How to show PC using the PC Soft Presenter and VNC:

1. Start the VNC software on your PC.
2. To use VNC, you must configure VNC Settings. Open VNC Settings in the Presentation Settings menu in Administrator Settings.
3. Fill in the IP address of your PC, Display Number and Password. See chapter 4.3.9 VNC Settings for more information.
4. Press Save.
5. When you now choose VNC as video source in the Presentation menu, you will see your PC using VNC. VNC settings will go back to default when the system goes to standby.

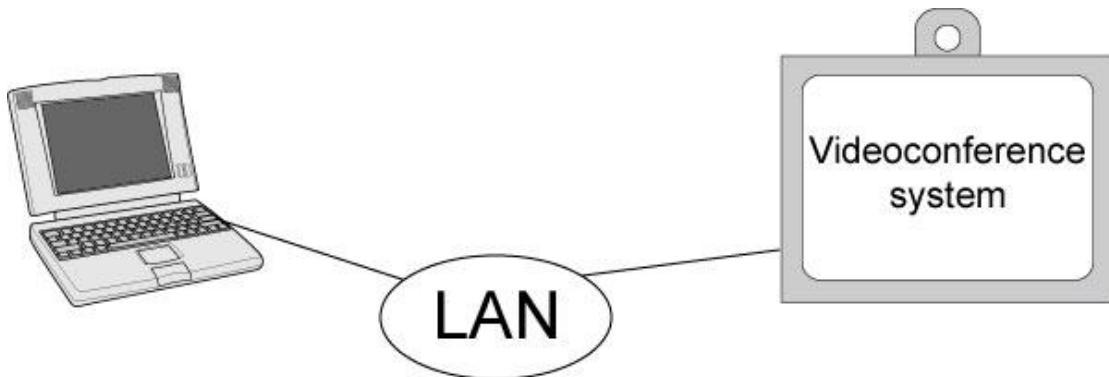

3.11.5 Duo Video TF/H.239

(Optional feature)

With Duo Video you have the opportunity to show two different live video streams simultaneously, main video and Duo Video. This is handy when showing a presentation. You see the live presentation and the live video of the presenter simultaneously. When you start a presentation, Duo Video starts automatically if both local and remote system supports Duo Video. If one of the systems does not support Duo Video, no Duo Video will be established and your presentation will be showed on your main video.

Example:

Start a meeting with main camera as video source. Press the presentation key on the remote control to start a PC presentation.

PC will appear as Duo Video in addition to main camera. End the Duo Video presentation by pressing presentation key again.

In Presentation Settings (see chapter 4.3 Presentation Settings), you can put Duo Video to Manual. That means that Duo Video will not start automatically.

Example:

Start a meeting with main camera as video source. Press the presentation key on the remote control to start a PC presentation.

A dialog box appears where you can choose to show PC as Duo Video or not. This is handy if you not always want to use Duo Video.

Duo Video and Bandwidth

Using Duo Video, the quality will automatically downspeed to the optimal bandwidth. This means that you need higher quality to allocate enough bandwidth for the two video streams. Duo Video borrows bandwidth from main video. When Duo Video is closed, the bandwidth is returned to the main video.

Controlling camera, changing video source and camera presets in a Duo Video call.

When selecting the Document Camera or PC, the system will automatically request floor when connected to a MCU conference as MultiSite host or connected to an external MCU.

The main monitor will display incoming video and the 2nd monitor will display outgoing video with Duo Video in full. Outgoing main video will be displayed in PIP. For a single monitor system, the Duo Video will be shown in full screen and the incoming video in PIP. Most Duo Video sources are not possible to control with move camera and presets. Move camera and presets will therefore work on the main camera also when you have Duo Video, with one exception. If you use a second camera (aux) as Duo Video, move camera and presets will work on Duo Video. If you want to control the main camera, press Move Camera from the main menu and choose Near End Camera.

3.11.6 Take New Snapshot

The system can take a snapshot of your live video. Snapshot is handy when you are in a call with a system that does not support Duo Video. Use Snapshot to show a snapshot of your presentation and continue the meeting with main camera.

How to use snapshot:

- You find Take New Snapshot in the Presentation menu. Press OK to take a snapshot.
- Snapshot is found on the Star key on the remote control. Press Star and you take a snapshot of the current video source (current video is default snapshot source). You can change snapshot source in Control Panel\Administrator Settings\Presentation Settings, see chapter 4.3 Presentation Settings. Note that snapshot does not work when you are in an input field in the menu (the star key is then used to write the star sign).

Note that Take New Snapshot is only available when you are in a call.

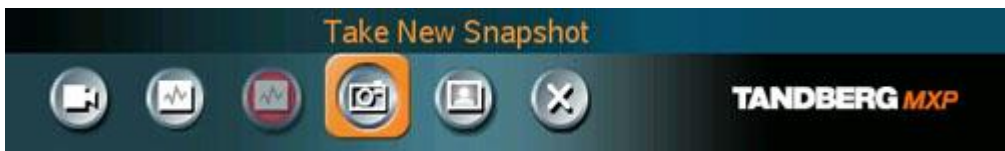

3.11.7 Display Snapshot

The system stores the last sent or received Snapshot. The snapshot is deleted automatically after the call.

How to display snapshot:

- To view a stored snapshot, choose Display Snapshot in the Presentation menu. Press the Display Snapshot button again to deselect it. When disconnecting the call, the stored snapshot will be erased.
- When receiving a snapshot, the snapshot is displayed in full screen. Press OK to escape from the snapshot. The last sent or received snapshot will be stored in the graphics memory.

Note that Display Snapshot is only available when you have a stored snapshot.

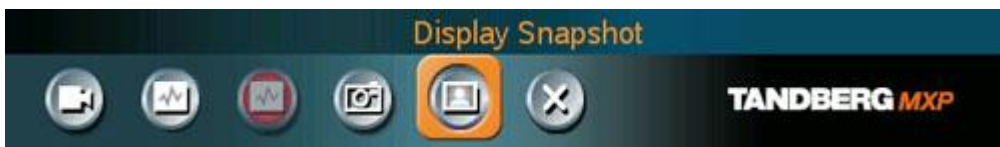

3.12 MultiSite Services

A Multipoint Control Unit (MCU) enables several sites to participate in the same conference. See chapter 3.5.3 Add Call for how to make a MultiSite call. In TANDBERG's embedded MCU, MultiSite, you can have a maximum of 4 video- and 3 telephone-participants including yourself (the host). The participants are tiled up on the screen and are on display simultaneously in a Split Screen. During a MCU conference, the status line will provide information about the conference.

You can make a multipoint conference in different ways. The MultiSite Services vary depending on how you make the call.

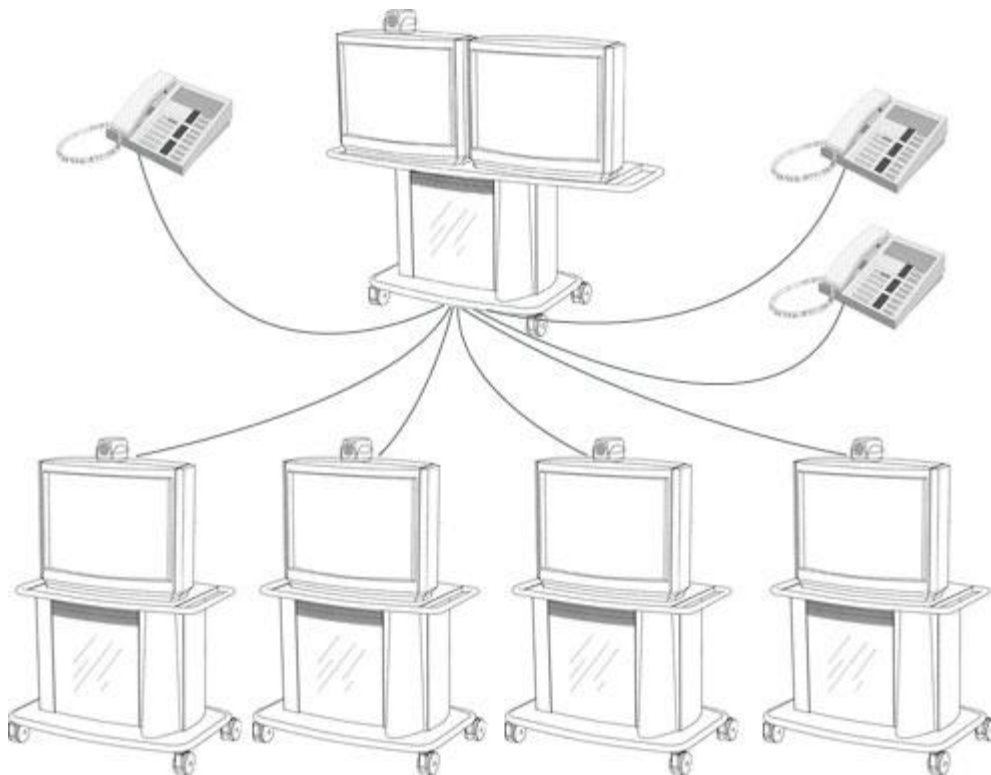

Using the system's internal MCU, MultiSite^{TF}

The system has an optional built-in MCU, which is called MultiSite. It supports up to 4 video calls and 3 telephone calls including yourself. The MultiSite supports both Split Screen and Voice Switched mode.

With MultiSite, you have the following services:

- Request/Release Floor
- Assign Floor To Participant/Release Floor From Participant
- Terminal Names
- Layout (Auto/4 Split/3+1 Split/Voice Switched)

Using an external MCU that supports Chair Control (H.243)

With an external MCU that supports H.243, you have the following services:

- Request/Release Floor

- View Participant/End View
- Chair Control

If you take Chair control, you get the following services:

- Release Chair
- Assign Floor To Participant/Release Floor From Participant
- Disconnect Participant
- Terminate Meeting

Using an external MCU that does not support Chair Control

With an external MCU that does not support H.243, you have the following services:

- Request/Release Floor
- Terminal Names

3.12.1 Request Floor and Release Floor

When requesting floor, your video will be broadcasted in full screen to all other participants in the conference. Request Floor is useful when you want to speak or display something in front of all participants. Therefore, floor will automatically be requested when taking a Snapshot or Selecting Document Camera or PC.

Release Floor when you are done and make the floor available for other participants in the conference. An indicator appears when you have floor and disappears when you release floor.

How to use Request and Release Floor:

1. Open the Main Menu by pressing OK.
2. Choose MultiSite Services and press OK.
3. Choose Request Floor and press OK. A Floor indicator will appear when you have floor.
4. When done, press the same button again, which now means Release Floor. The Floor indicator disappears.

3.12.2 MultiSite Layout

(Only supported by TANDBERG MultiSite)

With a TANDBERG MultiSite you can choose between the layouts: Auto Split, 4 Split, 3+1 Split and Voice Switched view. Auto Split displays all participants on the screen simultaneously. 4 Split displays the 4 last speaking Participants. 3+1 Split displays the speaking participant in a big picture and the 3 other participants in small pictures. Voice Switched mode displays the participant that is speaking in full screen. Switch between these picture modes using the MultiSite Layout menu.



Continuous Presence layout 4 split

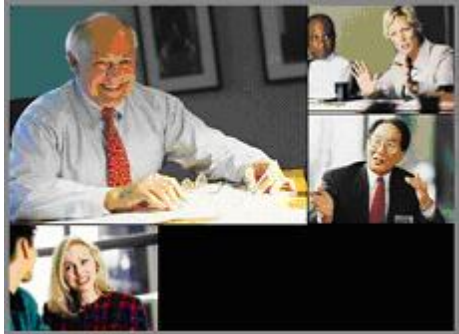

Advanced continuous Presence Layout (3+1)



Voice Switched mode

3.12.3 Terminal Names

Choose Terminal Names to see a list of the participants of the multipoint conference. Press Cancel to go back.

3.12.4 Chair Control

(Not supported by TANDBERG MCU or MultiSite)

As chairman, you have access to more MultiSite Services. Select Chair Control to assume the role of chairman of the conference. Select Release Chair to end the role as chairman. A Chair indicator appears when you have Chair and disappears when chair is released.

3.12.5 Assign Floor and Release Floor from Participant

Assign Floor allows the chairman to select which of the conference participants that is to be broadcasted to all other participants.

3.12.6 View Site and End View

(Not supported by TANDBERG MCU or MultiSite)

View Site allows you to view any participant in the conference regardless of whom having floor and chair. Choose End View to go back to normal.

3.12.7 Disconnect Participant

Disconnect Participant allows the chairman to disconnect any participant in the conference. In a multipoint call, this is equivalent to disconnecting a participant from the end call menu.

3.12.8 Terminate Meeting

Terminate Meeting allows the chairman to terminate the conference altogether. In a multipoint call, this is equivalent to pressing End All Calls from the end call menu.

3.12.9 More about MultiSite (embedded MCU)

(Optional Feature)

Calling in to a MultiSite

Any system can be part of a MultiSite conference by calling in to a MultiSite. The dial-in numbers to the MultiSite depends of the network that is used.

To dial in to the MultiSite on IP:

- Dial the IP Number or the IP Address of the system. All sites can dial the same number.

To dial in to the MultiSite on ISDN-PRI:

- Dial the ISDN number of the system. All sites can dial the same number.

To dial in to the MultiSite on ISDN-BRI:

- The MultiSite has specific numbers for each call that participates in the conference. To find the dial-in numbers for the MultiSite, choose Information from the main menu and open System Information from the bottom menu line.
- Site 2 must dial MultiSite Number 2.
- Site 3 must dial MultiSite Number 3.
- Site 4 must dial MultiSite Number 4.
- And so forth

Receiving calls to a MultiSite

When the MultiSite receives incoming calls you can accept or reject it. Pressing the green key is equivalent to pressing Accept. Pressing the red key is equivalent to pressing Reject.

End a MultiSite Call

Ending a MultiSite Call is not very different from ending a normal point-to-point call. Use the red key on the remote control or End Call from the main menu. The end call menu lists all the calls that participate in the conference. To end a single call, select the call, press OK or the red key on the remote control. To end all calls, press the End All Calls button in the menu.

Duo Video in MultiSite calls

In a MultiSite call, the MultiSite can transmit the Duo Video and/or H.329 to the other participants that support Duo Video and/or H.329. This means that any participant can send Duo Video and the MultiSite will transmit it to the other participants. The participants that do not support Duo Video or H.329 will only receive Main Video.

Bandwidth for MultiSite calls

If the MultiSite system does not have enough bandwidth to add another site, the system will automatically downspeed to allow an additional site to be added to the conference. Be aware of that Far End must support downspeeding and must have enough bandwidth. Downspeeding can be time consuming. In order to optimize connection time, use low bandwidth in the first call.

Example: The system has 512 kbps available and you want to connect 3 sites in addition to the host.

1. Begin the first call with Auto. As you add more participants with Auto Call Settings, bandwidths will downspeed. This is the simplest way to establish a MultiSite call, but downspeeding will lengthen the connection time.
2. To save time, specify 128 kbps for the calls. The system will end up with 4x128 kbps = 512 kbps.

The video calls in a conference do not have to use the same bandwidth. If you have enough bandwidth available, you can use 128 kbps on one call, while 384 kbps or any other bandwidth on another call in the same MultiSite conference.

MultiSite supports both Voice Switched and Split Screen mode (see chapter 3.12.2 MultiSite Layout for more about Layouts). The system has Auto Split as default picture mode.

Mix ISDN/LAN

A conference can consist of any combination of ISDN/IP sites.

MultiSite cascading

By connecting MultiSite systems together, it is possible to connect even more sites in a cascaded MultiSite (see example below). All connections can use any combination of ISDN/IP. The host can connect up to 5 other video systems with MultiSite functionality. The cascaded systems can connect to 4 other video sites. These systems will automatically run Voice Switched mode and transmit a full screen image to the host. In this case you get 20 participants in the cascaded MultiSite conference.

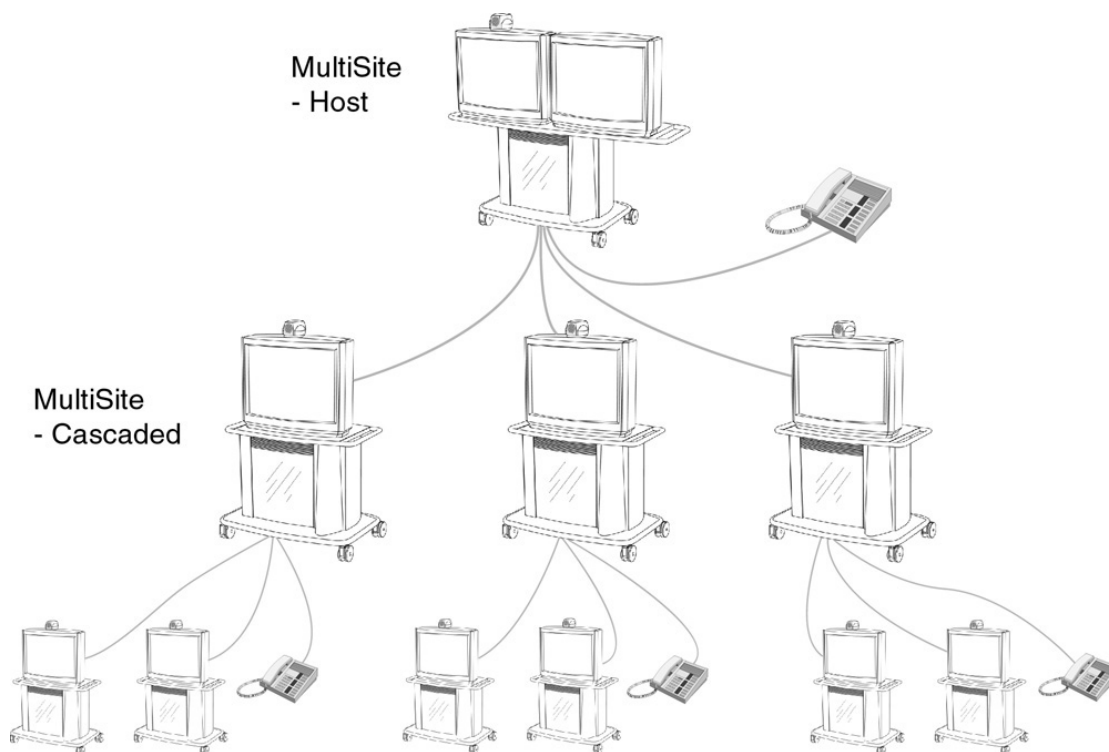

3.13 Control Panel



The Control Panel contains the features:

- User Guide
- Streaming
- Far End Control
- Camera Preset
- Camera Tracking
- Text Chat
- System Information
- Administrator Settings
- Restart

3.13.1 User Guide

The on screen user guide takes you through a quick step-by-step introduction to videoconferencing. It gives the user basic skills in how to use the system.



3.13.2 Streaming

Streaming lets you broadcast your meeting to participants on web. The web participants can listen to the meeting, see snapshots, but not participate themselves. Snapshots of current stream (if MultiSite), selfview, far end and DuoVideo streams are accessible via http. See Appendix 6 for descriptions of the possible snapshot files.

How to use Streaming:

1. Choose Streaming from the Control Panel to open the Streaming menu.
2. Press Start Streaming from the menu line.
3. Press Stop Streaming to end streaming. Streaming will also end when you disconnect the call.
4. Press Streaming Settings if you want to change streaming settings (see Streaming Settings below)

How to view streaming from a PC:

1. After streaming is started, an easy way to view the streamed audio/video is to start your Web browser and enter the IP-address of the streaming system.
2. After the Web page of the system is shown, click on Streaming. Alternatively, enter `http://<codec ip-address>/stream.sdp`

Streaming Settings

Address	Address is defined as the IP-address of a streaming client, streaming server or a multicast address. Giving an address in the range 224.0.0.1-239.255.255.255 will broadcast the stream to any host that has joined the specified multicast group. Specifying normal broadcast address 255.255.255.255 will broadcast to any members on the LAN.
Address Port	If several codec's are streaming to the same IP-address, different ports have to be used in order for the client to know which stream to receive. If the first codec streams on port 2240 and the second codec on port 2250, the client has to specify which port to listen to. Video is transmitted on the specified port; audio is transmitted on the port number 4 above the specified video port, in this case 2244 and 2254.
TTL/Router Hops	This is used for streaming data to limit how many routers the data should pass before it is rejected. If TTL is set to 2, data will not traverse more than 2 router hops.
Streaming Source	<ul style="list-style-type: none"> ▪ Auto: Enables streaming of both local and far end video. Selection of which site to be streamed is done using voice switching (the site that speaks is streamed). ▪ Local: Only the local video will be streamed. ▪ Remote: Only the far end video will be streamed. <p>Local and far end audio is always streamed.</p>

Allow Remote Start	<ul style="list-style-type: none"> ▪ On: Streaming can be started from external user interfaces like the Web-browser or Telnet session. ▪ Off: Streaming can only be started from the Video Conferencing System using the remote control, or by using the Data port. This will prevent activation of streaming using Web browser or Telnet sessions. See also Password section below
Announcements	<ul style="list-style-type: none"> ▪ On: The codec will announce to the network that it is streaming. This enables a streaming client (e.g. a PC) to connect to the codec's streaming session. Used by Cisco IP/TV. ▪ Off: No announcement packets will be transmitted.
Video Rate	Defines the Video streaming rate from the system. Range is 16 kbps - 320 kbps. In addition, audio (G.711) streaming rate is 64 kbps, providing a maximum streaming rate of 384 kbps.
Streaming Password	Set password so that only participants entering correct password will be able to view the streaming session. Entering a password will prevent unauthorized people from accessing the streaming session.

3.13.3 Far End Control

It is possible to get some control of the far end system. This means that you can control your conference partner's camera, video sources and presets. You can also request a snapshot from the far end side. Enabling Far End Control in the Control Panel will put the system in Far End mode and camera control, camera preset, presentation, and snapshot will work on the far end camera.

Far End Control only works if the far end side supports H.281 (Far End Camera Control). You can prevent others from controlling your system by setting Allow Far End Camera Control to Off in Control Panel\Administrator Setting\General\Permissions (chapter 4.1.7 Permissions).

How to use Far End control:

1. Open the Control Panel.
2. Enable Far End Control by selecting the Far End button in the Control Panel. A green circle indicates that the Far End button is activated.
3. Now you are in Far End mode and can use camera control, camera preset, presentation and snapshot for the far end.
4. To turn Far End control off, go to the control panel again and press Far End again. The green circle disappears.

Far End Camera Presets

Far End Camera Presets works just like your own camera presets. When Far End is on, use the number keys to activate far end camera presets. You are however not allowed to save far end camera presets.

Far End Presentation

Pressing the Presentation key or choosing a presentation from the presentation menu while Far End is on, will result in opening a far end presentation. Be aware of that the far end video sources may not correspond with the buttons in the presentation menu. If you press Document Camera, the far end side might have another video source on this input.

Request snapshot from the Far End

You can request a snapshot from the far end side. Put the system in Far End mode and press Snapshot on the remote control to take a snapshot of the current far end video (current is default snapshot source).

3.13.4 Camera Preset

In the Display menu you find Display Presets and Save Preset



Display Presets displays camera presets 0-9 in a menu. The disabled buttons represent camera presets that are not saved yet. Use arrow keys to select a camera preset.



Save Preset will take you to the save presets menu. Enter a number and you will save the current camera position. Note that you can save camera presets by pressing a number for 1 second. Use the Save Preset menu if you need to save presets 10-14 (see chapter 3.10.3 Camera Presets).

3.13.5 Camera Tracking

Through Camera Tracking and the use of two or three microphones, the camera can automatically position itself on the current speaker. Before using camera tracking, the camera positions used must be stored at Preset 7 (Mic1) and/or Preset 8 (Mic2).

How to use Camera Tracking:

1. Open the Control Panel.
2. Enable Camera Tracking by choosing Camera Tracking in the Control Panel. An indicator will appear as you enable Camera Tracking.
3. End Camera tracking by deselecting the button. Camera Tracking will also end if you activate a Camera Preset or move the camera manually with the arrow keys.

Example: You have placed Microphone 1 on the table. Where should you position the camera for Preset 7?

The camera position stored at Preset 7 must be related to Microphone 1. Therefore all participants who are located closest to Mic1 should be included in the Preset 7 camera position etc. When camera tracking is activated and a person close to Mic1 speaks, Preset 7 will be automatically selected.

When activating another video source (for instance document camera), camera tracking will be temporarily disabled until you re-select Main Camera or a Main Camera Preset.

The camera tracking speeds may be altered in the Video Settings menu in Administrator Settings, see chapter 4.6.1 Camera Tracking Mode for further details.

A Voice Detector makes the system more tolerant of noise and ensures the camera not to be moved by noise such as paper shuffling, etc.

Note that pressing Mic Off will temporarily disable camera tracking until you turn on the microphone again.

3.13.6 Text Chat

While in an ISDN or IP call to another system supporting Text Chat (T.140), select Text Chat from the Control Panel. Enter text in the displayed window.

How to use Text Chat:

1. Choose Text Chat from the Control Panel to open the Text Chat window.
2. Enter text with the number keys like on a mobile phone. The text is sent to the far end continuously letter by letter.
3. Press OK to end Text Chat and escape from the text chat window.

3.13.7 System Information

In System Information you find all information about the system.

The most useful information for users is listed first:

- System Name
- My ISDN Number
- My IP Number
- My IP Address
- MultiSite Number(s)
- Software Version
- Option Installed
- Serial No
- MAC address
- Ethernet Speed
- Network

In system information you also find:

- Call Status
- Channel Status
- View Administrator Settings

For more information, see chapter 4.9 Diagnostics.

3.13.8 Administrator Settings

Administrator Settings contains the configuration of the whole system. It is recommended to password protect Administrator Settings to prevent occasional users to make changes to the system. See Chapter 4 Administrator Settings for further details.

3.13.9 Restart

Restart the system by pressing the Restart button. You are prompted with a dialog box saying: Do you want to restart the system? Press OK to restart, press Cancel (X) to abort.

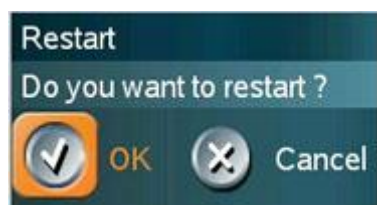

4 Administrator Settings



Administrator Settings contain all the settings of the system. Making changes to Administrator Settings will change the behavior of the system. It is recommended to password protect the access to Administrator Settings to prevent occasional users from making crucial changes to the system, see chapter 4.2.9 Administrator Password.

Administrator Settings contain:

- General Settings
- Menu Settings
- Presentation Settings
- Call Quality
- Audio
- Video
- Security
- Network
- Diagnostics

4.1 General Settings

When installing the system, go through the General Settings menu to ensure that you have the right settings for your system, see chapter 2.4 System Configuration.



General Settings contain:

- Language
- System Name
- Dual Monitor
- Autoanswer
- Max Call Length
- Global Phone Book Settings
- Permissions
- Screen Settings
- Software Options

4.1.1 Language

The system supports 12 different languages for its on-screen menus; English, German, French, Norwegian, Swedish, Italian, Spanish, Portuguese, Chinese Simplified, Chinese Traditional, Japanese and Russian. Select the preferred language and press OK to save.

4.1.2 System Name

System Name identifies the system:

- on the welcome page.
- during an MCU conference call.
- when using the Web-interface.
- when the codec is acting as an SNMP Agent.
- towards a DHCP server.
- as an H323 ID. Other systems can call in using this name instead of IP-number/IP-address.

System Name is blank by default. System name can be alphanumeric and up to 50 characters long. Follow the installation procedure to enter a System Name.

4.1.3 Dual Monitor

TANDBERG systems can be used with both one or two monitors. If you use two monitors, make sure that Dual Monitor is set to On.

On	Selfview, snapshots and Duo Video will be displayed on the second monitor.
Off	The second monitor shows selfview only.

4.1.4 Autoanswer

The auto answer setting decides whether an incoming call is put through automatically or manually.

On	The system will automatically answer all incoming calls.
On+MicOff	The system will automatically answer all incoming calls and switch the microphone off when the call is connected. Press Mic Off to switch the microphone on.
Off	You must manually answer all incoming calls by pressing OK or the Call key.

4.1.5 Max Call Length

This feature will automatically end both incoming and outgoing calls when the call time exceeds the specified Max Call Length. Max Call Length can have the following values: 0-999 (minutes), where 0 means off.

4.1.6 Global Phone Book Settings

Global

On	Global Phone Book is available in the menu.
Off	Global Phone Book is hidden from the menu and is unavailable for users.

IP address

Enter the IP address of the management system that provides the Phone Book.

Path

The Path indicates the function of the management system.

4.1.7 Permissions

Permissions contains settings for incoming MCU Calls, incoming telephone Calls, Far End Control and Fallback to Telephony.

Incoming MCU Calls

On	When you are in a call, the system will provide visual and audible indications of an incoming call and ask you to accept/reject the call.
Off	The system will not accept incoming calls when you are in a call.

Incoming Telephone Calls

On	The system will accept incoming telephone calls.
Off	The system will not accept incoming telephone calls. This is useful to prevent incoming calls from systems other than videoconferencing systems.

Far End Control

On	The far end will be able to: <ul style="list-style-type: none"> • Control your camera • Select your video sources • Activate your camera presets • Request snapshots
Off	The far end can access none of the four features above on the local system. You will however still be able to control the camera on the far end.

Fallback to Telephony

When dialing a number and the system fails to place a video call to the number dialed, the system will attempt to place a telephone call if Fallback to Telephony is enabled.

On	Enables fallback from video calls to telephone calls.
Off	Disables fallback.

Access Code

An access code will help you control the use of the system. All users must enter a code to identify themselves and the call will be charged on their account. Access Codes are handy for group systems where there are more users or divisions that share the costs of using the system. Access Code can be put to On and Off.

On	When making a call, an Access Code dialog box will be shown. The user must enter the correct password in order to put the call through.
Off	No password is necessary to make a call.

4.1.8 Screen Settings

Picture Layout(wide screen monitors only)

The Advanced Picture Layout is related to the Layout button on the remote control and it can be used at any time to change the screen layout. For wide screen systems POP mode is recommended. You will get optimized picture layouts for wide screen by pressing the Layout button on the remote.

Picture in Picture (PIP)	Pressing the Layout button on the remote will result in an extra picture in smaller view (Picture in Picture. Press the Layout button to move it and finally hide it.
Picture outside Picture	Pressing the Layout button on the remote will result in a smaller view placed outside the big picture. Press Layout once more to get emulated dual monitor view. Press Layout again to go back to normal full screen

(POP)

view.

Pressing the Layout button on the remote will result in one large image and one or two smaller pictures placed outside the big picture. Press Layout once more to get a side by side view. Press Layout again to go back to normal full screen view.

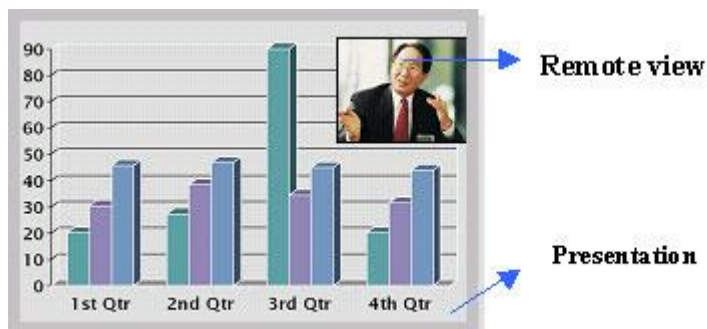

Example of Picture in Picture.

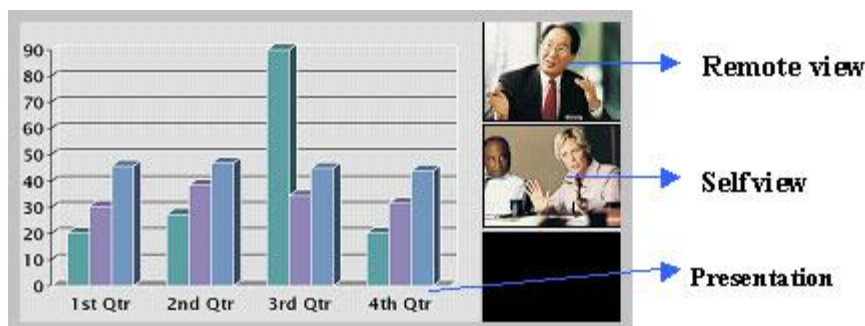

Example of Picture outside Picture (wide screen).

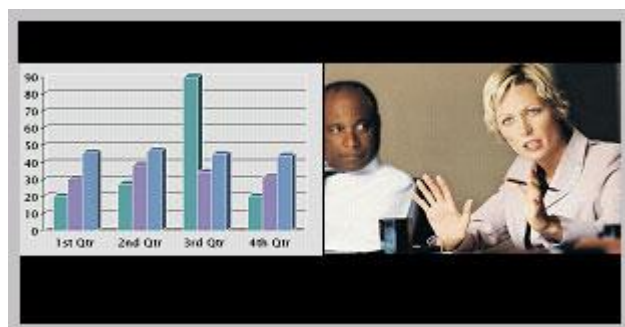

Example of Side by Side view (wide screen).

TV Monitor Format(wide screen monitors only)

To fully leverage your wide screen display, activate the Native 16:9 format by setting the TV Monitor Format to Wide. Note that you should only change this setting if your TV monitor is a wide screen (16:9) monitor or projector. All composite- and s-video output format will then be optimized for Wide Screen TV monitors.

Normal	Output format is optimized for Normal TV monitors (4:3)
Wide	Output format is optimized for Wide TV monitors (16:9)

VGA Monitor Format

To fully leverage your wide screen display, activate the Native 16:9 format by setting the VGA Monitor Format to Wide. Note that you should only change this setting if your VGA monitor is a wide screen (16:9) monitor or projector. The VGA and DVI output will then be optimized for Wide Screen VGA display.

Normal	Output format is optimized for Normal VGA monitors (4:3)
Wide	Output format is optimized for Wide VGA monitors (16:9)



Wide screen VGA or TV monitor in Normal (stretched) mode.



Wide screen VGA or TV monitor In Wide (native) mode.

VGA Out Mode

VGA Out Mode makes it possible to specify which signal to sent to the VGA/DVI output.

Main	Should be used if you want to use a VGA monitor as your main monitor.
Dual	Should be used if you want to use a VGA monitor as your dual monitor.

VGA Out Quality

The supported range of VGA formats will be optimized for the VGA display monitor based on the source image.

VGA Out Quality enables the user to change the preferred format for the DVI/VGA output. It is recommended to keep this setting in Auto unless your screen doesn't support some of the XGA or SVGA formats the system is using. Note that the VGA Out port support VESA Power Management.

Auto	VGA output format will be optimized dependant of the video source format, refresh and of the EDID information available. Supported formats are: SVGA (800x600) 75Hz SVGA (800x600) 90Hz XGA (1024x768) 60Hz XGA (1024x768) 75Hz
SVGA 800x600 72Hz	VGA output format is forced to SVGA format (800x600) 75Hz
XGA 1024x768 60Hz	VGA output format is forced to XGA format (1024x768) 60Hz

PC Picture Format (16:9 monitors only)

PC Picture Format setting only takes effect when TV or VGA Monitor Format is set to Wide. Use this setting to determine if you want your PC presentations to be shown stretched in full screen, or with correct aspect ratio using part of the widescreen display

Normal	VGA output will have 4:3 aspect ratio on wide screen monitor.
Wide	VGA output will utilize the wide screen monitor at full.

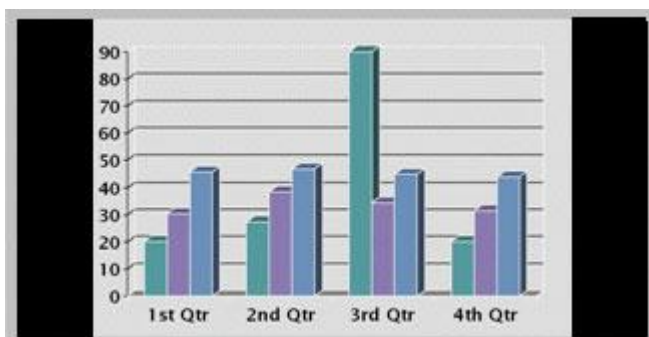

PC presentation shown in Normal (correct ratio) mode.

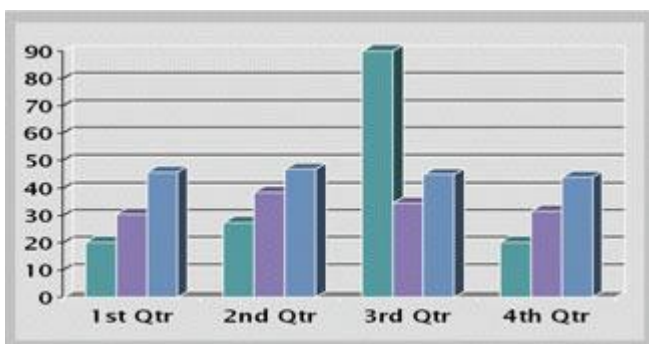

PC Presentation shown in Wide (stretched) mode.

4.1.9 Software Options

The system requires a valid option key to activate MultiSite and/or Presenter functionality. In order to activate additional bandwidth, you need to enter a bandwidth key. A restart of the system is required after entering a new option and/or bandwidth keys. If the key is invalid, the original key will be used.

The following options are available:

1. No option
2. Presenter
3. MultiSite + Presenter
4. Bandwidth options

4.2 Menu Settings



Menu Settings contain the settings:

- Menu Timeout In Call
- Welcome Menu
- Welcome Picture
- Logo
- Menu on TV
- Menu on PC
- Display Welcome Text
- Welcome Text
- Administrator Password

4.2.1 Menu Timeout In Call

Main menu appears on the bottom line of the screen. Set Menu Timeout In Call to On if you want the menu to time out automatically when you are in a call.

On	The menu will time out automatically after 15 seconds if there is no activity on the remote control. Menu timeout does only apply when you are in a call. Outside a call, the menu will not time out.
Off	The menu will not time out automatically. Press Cancel (X) to hide the main menu manually.

4.2.2 Welcome Menu

The Welcome Menu contains the Main Menu, System Status, your System Name and dial in numbers.

On	The Welcome Menu is shown when the system wakes up from standby mode.
Off	The Welcome Menu is not shown when the system wakes up from standby mode. Press the OK button to open the welcome menu.

4.2.3 Welcome Picture

The Welcome Picture is what you see in the background of the welcome menu.

Selfview	Selfview is shown in the background of the welcome menu. In most cases this means that main camera is displayed and you can see the video image of yourself.
Off	No picture is shown in the background of the welcome menu.

4.2.4 Logo

It is possible to upload a company logo to the system. For more information about how to upload a Logo, see Appendix 6. Put the Logo settings to On to display the logo.

On	Choose On if you want the company logo to appear in the background of the welcome menu.
Off	The logo is not displayed.

4.2.5 Menu on TV

The Menu on TV setting decides if the menu shall be displayed on the TV screen or not. For optimal layout of the menu, 'Menu on TV' should be Off if 'Menu on PC' is On and vice versa.

On	The menu is available on the TV screen.
Off	The menu is not available on the TV screen.

4.2.6 Menu on PC

The Menu on PC setting decides if the menu shall be displayed on the PC (VGA screen) screen or not. For optimal layout of the menu, 'Menu on TV' should be Off if 'Menu on PC' is On and vice versa.

On	The menu is available on the PC screen.
Off	The menu is not available on the PC screen.

4.2.7 Display Welcome Text

The welcome text displays your system name and dial in numbers by default. It is possible to hide this information by choosing Display Welcome Text Off.

On	Welcome text is displayed on the welcome menu.
Off	Welcome text is not displayed on the welcome menu.

4.2.8 Welcome Text

You can change the welcome text to any text you like, instead of the default text. Remember that Display Welcome Text must be On to be able to edit the welcome text.

4.2.9 Administrator Password

It is recommended to put an Administrator Password on the system. The Administrator Password can be maximum 5 digits long. The Administrator Password dialog box will pop up when you choose Administrator Settings from the Control Panel. This will prevent occasional users from going in to administrator settings. With an administrator password, you can ensure that your system will behave in the same way every time and that only dedicated people are allowed to make changes to the system.

On	The user must enter an Administrator Password to be able to enter Administrator Settings.
Off	Administrator Settings are available for all users of the system.

4.3 Presentation Settings

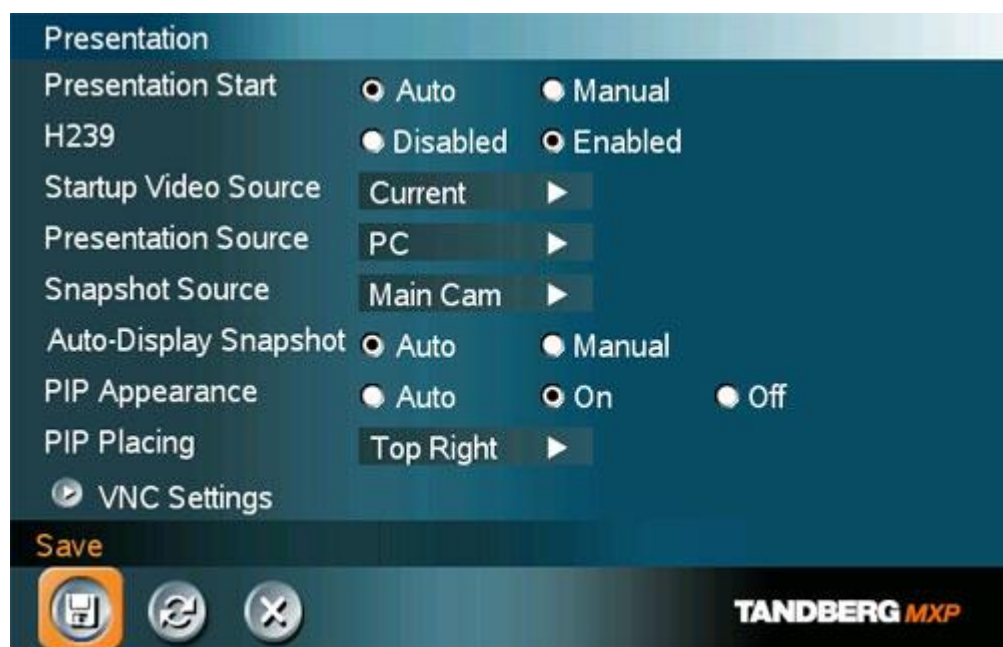

Presentation Settings contain:

- Presentation Start
- H.239
- Startup Video Source
- Presentation Source
- Snapshot Source
- Auto-Display Snapshot
- PIP Appearance
- PIP Placing
- VNC Settings

4.3.1 Presentation Start

If your system has Duo Video capabilities, you can show two video streams at the same time (see also chapter 3.11.5 Duo Video). Presentation Start is Auto by default. This means that you will start Duo Video (a second video stream) automatically when starting a presentation. Duo Video requires the Presenter Option and H.263 video. To check which options are installed, see the System Information menu in Control Panel.

Manual means that you manually choose if you want to start Duo Video or not every time you start a presentation.

Auto	Duo Video starts automatically when you start a presentation (in other words, when you choose a second video source). If your system or the far end system is not capable of Duo Video, you will not use Duo Video, but rather send the presentation source as your Main Video
-------------	--

Manual	When starting a presentation, a dialog box appears asking if you want to start Duo Video. In this way you can choose manually if you want to use Duo Video or not.
---------------	--

4.3.2 H.239

H.239 supports transmission of two video streams. It combines elements of Duo Video and People+Content. If H.239 is disabled you will still be able to start TANDBERG Duo Video.

Enabled:	Enables H.239
Disabled:	Disables H.239

4.3.3 Startup Video Source

The Startup Video Source is the video source on display when the system wakes up from standby mode. If you use Main Camera as start up source, the system will start with Main Camera every time the system wakes up from standby, regardless of what the previous user was using.

You can change Main Video Source to Main Camera, PC, Document Camera, VCR, AUX, VNC or Current. Choosing Current will result in the last used video source before the system went to standby.

4.3.4 Presentation Source

The Presentation Source is connected to the Presentation button on the remote. Pressing the Presentation button will put the Presentation Source on display. Presentation Source is PC by default. You can change the Presentation Source to any video source and none. Choosing none results in opening the Presentation menu when pressing the Presentation key.

4.3.5 Snapshot Source

When you take a Snapshot, you get a snapshot of the Snapshot Source. Current is the default Snapshot Source. This means that you take a snapshot of the video source that is currently active.

You can change the Snapshot Source to any video source. In this way you can program the snapshot key to apply only for PC for instance. Press Snapshot and you will take a PC snapshot regardless of what video source that is currently active.

4.3.6 Auto-Display Snapshot

Select Auto to automatically display a received snapshot. Turn Auto-Display Snapshot Manual if you wish not to have them displayed on the screen when they are sent or received. The snapshots will be sent and received, but not displayed. With Auto-Display Snapshot set for Manual, you must enter the Presentation menu to display a snapshot.

Auto	A sent or received snapshot will automatically be displayed on the screen.
Manual	A sent or received snapshot will not be displayed on the screen. To see the snapshot, choose Display Snapshot in the Presentation menu.

4.3.7 PIP Appearance

A Picture in Picture (PIP) is a smaller picture placed in one of the corners of the screen. The PIP enables you to see an extra picture in your video conference.

Auto	PIP Auto means that Picture In Picture will appear automatically when it is suitable. A picture in picture is nice when you use Duo Video and you need an extra window to see all the pictures. You can of course show or hide the PIP with the Layout button on the remote anytime.
On	PIP On means that a Picture in Picture will always be displayed.
Off	PIP Off means that PIP is not displayed automatically.

4.3.8 PIP Placing

PIP Placing lets you decide where the PIP shall appear. You can of course move the PIP with the Layout button on the remote anytime.

Top Right	PIP is placed in the Top Right corner.
Bottom Right	PIP is placed in the Bottom Right corner.
Bottom Left	PIP is placed in the Bottom Left corner.

Top Left	PIP is placed in the Top Left corner.

4.3.9 VNC Settings

VNC Settings is necessary when using a VNC presentation. See chapter 3.11.4 PC Soft Presenter and VNC for more about how to use VNC.

Address	The IP-address of the PC with the VNC software installed. To find the IP-address of the PC, place the mouse pointer on the VNC program icon in the lower right corner of the Windows taskbar. You can also select Command Prompt from the Startup-menu\Run and type cmd then enter. This will open a command window and from here. Type "ipconfig" and press enter.
Display Number	The display number for VNC is 0 and upwards. If you are using WinVNC, double-click on the icon on the taskbar to view WinVNC properties. This number should correspond with Display Number in this menu.
Password	Enter the same password as specified in WinVNC properties. The password will be shown as asterisk signs (*) the next time you enter the menu.

4.4 Call Quality



Call Quality contains the settings:

- Video Algorithm
- Audio Algorithm
- AAC-LD 128kbps
- Natural Video
- Video Quality
- Default Call Settings

4.4.1 Video Algorithm

The system will automatically select the best video algorithm based on the video source and the capabilities of the remote system. Use this menu to disable video algorithms in case you have interoperability issues calling other systems.

H.264	Bandwidth efficient video compression and decompression.
H.263	Normal video compression and decompression.
H.261	Legacy video compression and decompression. The system will always have H.261 enabled. Therefore it is impossible to uncheck H.261.

4.4.2 Audio Algorithm

The system will automatically select the best audio algorithm based on the call rate and the capabilities of the remote system. Use this menu to disable audio algorithms in case you want to remove “low quality” audio, or if you have interoperability issues calling other systems.

G.722	High quality audio (7 kHz at 48kbps, 56kbps or 64kbps)
G.728	Compressed normal quality audio (telephone quality, 3.1 kHz at 16kbps)
G.711	Normal quality audio (telephone quality 3.1kHz at 64kbps). This audio algorithm is mandatory for video conferencing equipment and is impossible to uncheck.
G.722.1	Compressed high quality audio (7 kHz at 24kbps and 32kbps).
AAC_LD	CD-quality audio, MPEG-4 Advanced Audio Coding Low Delay 20 kHz, stereo at 128kbps 20kHz, mono at 64kbps

Call Rate vs Audio algorithms selected

Modify/remove algorithms used by uncheck the different audio algorithms

Automatically preferred audio algorithms on call rates up to and including 192kbps

1. G.722.1 (24kbps or 32kbps)
2. G.728 (16kbps)
3. AAC-LD (56kbps or 64kbps)
4. G.722 (48kbps, 56kbps or 64kbps)
5. G.711 (48kbps, 56kbps or 64kbps)*
6. AAC-LD (48kbps or 128kbps)

Automatically preferred audio algorithms on call rates above 192kbps

1. AAC-LD (128)**
2. AAC-LD (64kbps or 56kbps)
3. G.722 (64kbps, 56kbps or 48kbps)
4. G.722.1 (32kbps or 24kbps)
5. G.728 (16kbps)
6. G.711 (64,56,48)*
7. AAC-LD (48)

* AAC-LD, G722 and G711 at 64kbps is used for audio in H323 (IP) calls only

** Dependant that the call rate is above the AAC-LD 128 treshold.

4.4.3 AAC-LD 128kbps (stereo audio)

Specify a call rate for 128kbps AAC-LD. From this call rate and above, "128kbps AAC-LD" is available. On lower call rates "64kbps AAC-LD" is available.

Stereo audio requires twice the bandwidth as mono CD-quality audio. Therefore we recommend to enable stereo audio on high call rates only. To enable stereo CD-quality audio you need to specify a call rate for when stereo automatically should be enabled. On lower call rates, mono CD-quality audio "64kbps AAC-LD" will be enabled.

4.4.4 Natural Video

Choosing Natural Video will enable 60 fields per second true interlaced picture for high motion video.

Auto:	Natural Video Auto will enable transmission of Natural Video from 768 kbps and above. Reception of Natural Video is in this case always enabled.
Off:	Natural Video Off will disable both transmission and reception of Natural Video.
Custom:	384 kbps and above to 1920 kbps and above

4.4.5 Video Quality

The different video sources need different Video Quality Settings. Main Camera, VCR, AUX and Split Screen have Motion as default. PC, Document Camera and VNC have Sharpness as default.

Motion:	Optimized for smooth motion video (CIF/SIF for low bandwidths, iCIF/iSIF for high bandwidths).
Sharpness:	Optimized for sharp video (4CIF/4SIF, VGA, SVGA, XGA).
Auto:	The system chooses the best of Motion or Sharpness depending on picture layout and bandwidth.

4.4.6 Default Call Settings

Default Call Settings are connected with Call Settings in the call menu. If you leave Call Settings unchanged when making a call, the system will use the Default Call Settings in the call. See chapter 3.5.4 Call Settings for more information.

In addition to the call Settings Call Type, Net, Bandwidth and Restrict (56k), you also find settings for H.320 Auto bandwidth and H.323 Auto bandwidth in Default Call Settings.

4.5 Audio



Audio contains the settings:

- Inputs
- Outputs
- Echo Control
- Stereo Settings
- Audio Leveling (AGC)
- Alert Tones and Volume

4.5.1 Inputs

Mic 1- 2 and Audio input 3-4

By default, all inputs are enabled. Just plug in an audio source and it is active. Audio inputs that are On will automatically be mixed. Unconnected inputs will automatically be muted. Select Off to prevent audio/noise from connected but unused inputs. The activated audio sources are stored on camera presets.

Mic 1 and 2 are intended for electret type microphones. The microphone inputs are balanced with 24V phantom power.

Audio input 3 (AUX) is intended for connection to external playback devices or to telephone add-on hybrids. As there is no acoustic echo canceller on this input it should not be connected to any microphones. The audio source connected to this input will be heard from the local speaker as well.

Audio input 4 (VCR) is intended for connection to a VCR or DVD player. It can also be connected to other external playback devices. As there is no acoustic echo canceller on this input it should not be connected to any microphones. The audio entering this input will be heard from the local speaker as well. If Auto is selected, the audio from the VCR will only be heard when VCR is selected as video source.

Mix Mode

Auto	The adjustment of each microphone signal is done automatically to obtain the best possible audio and minimize the background noise.
Fixed	Fixed will maintain a constant weighting of all microphones.

VCR Ducking

If VCR Ducking is activated, the VCR audio level will be attenuated if someone talks into the microphone or at the far end.

Level Settings

It is possible to adjust the audio input levels according to which external audio equipment is connected. The on-screen audio level indicator will make it easier to set the correct input level settings. The input level should be adjusted so that the average level reaches the preferred level marker. The audio inputs are adjustable in steps of 1.5 dB from 0 dB to 22.5 dB.

The default levels for Mic 1 and 2 are set for use with an Audio Technica AT871R or AT841R microphone in an average videoconferencing room. The gain can be adjusted correctly for a wide range of microphones.

A few examples of microphone levels are:

Audio Technica AT871R	+3dB (default)
Audio Technica AT851R	+7dB
TANDBERG Audio Science	+19.5dB

Audio inputs 4 and 5 are set to a default level which is adhered to by most manufacturers of audio-visual equipment and is a level at which most audio-visual equipment (CD-players, VCRs or DVDs) will work.

4.5.2 Outputs

Audio out 1 - 2

Audio out 1 is intended for connection to televisions or audio amplifiers.

Audio out 2 is intended for connection to a VCR or other recording equipment. The signal is a mix of audio from far end and local end (not from Audio in 4).

Note that audio out 2 never should be connected to a loudspeaker placed in the same room as the microphones connected to the system. This will cause “howling” and possible damage to the speaker system. If an output is Off, no audio will be sent to that output.

Out 1 Mode

If Out 1 Mode is set to Auto, the system will select analog or digital (SPDIF) mode dependent on the detected Audio Module. If a TANDBERG Digital NAM is detected, SPDIF mode will be selected, otherwise analog mode will be selected.

Setting the Out 1 Mode to either Analog or SPDIF will override the auto-detected mode.

Audio Module

Select Audio Module according to the type of Audio Module installed if this is not automatically detected. The Audio Module setting is only available if the audio module of the system is unidentified.

Level Settings

Adjust the audio output levels according to the parameters of the external audio equipment connected. These levels should only be adjusted when installing new audio equipment. The default settings are correct for the TANDBERG Digital Natural Audio module and for most consumer electronics devices (televisions, VCRs, etc.). The volume keys on the remote control adjust the level of output 1 (the speaker output). The volume control has no effect on other outputs.

4.5.3 Echo Control

Mic 1-2 and Audio 3

Each of the 2 microphone inputs and Audio input 3 has a separate acoustic echo canceller. One echo canceller per input provides more sophisticated control than having one common canceller for all microphones.

In addition to echo cancellation, the system has built-in noise reduction (NR). NR reduces constant background noise (e.g. noise from air-conditioning systems, cooling fans etc.). In addition, a high pass filter (Humfilter) reduces very low frequency noise.

On:	Echo control is normally set to On to prevent the far end from hearing their own audio. Once selected, echo cancellation is active at all times. The echo canceller continuously adjusts itself to the audio characteristics of the room and compensates for any changes it detects in the audio environment. If the changes in the audio conditions are very significant the echo canceller may take a second or two to re-adjust.
Off:	You can choose to switch off the echo canceller for the available audio sources. Echo Control should be switched Off if external echo cancellation or playback equipment is used.
On+NR:	Activates both Echo Control and Noise Reduction.

Note that it is your echo canceller that improves the audio quality experienced by the other site. When you hear an echo of your own audio it is most likely the far end's echo canceller that is malfunctioning.

Tips for improving the echo canceller performance:

- Place all microphones as far as possible from the loudspeaker. Minimum loudspeaker-microphone distance should be 2 meters.
- It is recommended to place the microphones between 1 and 2 meters away from the persons speaking. By using several microphones, the ratio distance loudspeaker-to-mic/mic-to-speaker can be increased. Increasing this ratio improves the echo canceller performance.
- Place all microphones as far as possible from noise sources.
- Reduce the volume setting. Ensure that the loudspeaker does not distort the audio.
- The echo canceller tries to estimate the echo path from the speaker system to the microphones. Moving objects change this path, therefore try to avoid moving objects. Be especially aware of large objects and objects placed close to either the microphone or the speaker system as these objects will cause severe changes to the echo path.
- Avoid putting paper sheets etc. on the microphone.
- Avoid moving the microphone or loudspeaker.
- In the presence of low frequency noise, enable the noise reduction (NR).

4.5.4 Stereo Settings

Stereo Input mode (stereo audio)

If stereo Input mode is activated, audio input 3 and 4 will behave as a stereo input pair. The VCR Ducking and AGC setting for audio input 4 will in this case apply to both audio input 3 and 4.

If Stereo Input Mode is off, Audio out 2 will be a mix of audio input 3, microphones and the far end (mono or left+right). If Stereo Input Mode is on, Audio out 2 will be a mix of the microphones and the far end (mono or left+right).

Note that you are able to receive stereo through Audio out 1 (S/PDIF) independent of this setting.

4.5.5 Audio Leveling (AGC)

On	Select On to allow automatic adjustments (Automatic Gain Control) of audio levels. When On, the AGC maintains the audio signal level at a fixed value by attenuating strong signals and amplifying weak signals. Very weak signals, i.e. noise alone, will not be amplified.
Off	Audio leveling is not activated.

Note that to ensure correct behavior of the AGC, it is crucial that the levels on the input connectors are adjusted correctly using the audio input level settings. The AGC will not compensate for severe maladjustment of input levels.

When applying a weak signal in the presence of strong background noise, the AGC might amplify the background noise as well as the signal. Therefore, in noisy environments, it is advisable to turn the AGC off.

Example:

In most conferences, the participants will speak at different levels, and be at different distances from the microphones. As a result, some of the participants would be harder to hear than others. The AGC corrects this problem by automatically increasing the microphone levels when “quiet” or “distant” people speak, and by decreasing the microphone levels when “louder” people speak.

4.5.6 Alert Tones and Volume

Video Call Alert Tone and Telephone Alert Tone

To help distinguish between incoming video calls and ordinary telephone calls, it is recommended to use different ringing tones for video calls and telephone calls.

Alert Volume

You may change the volume level for the selected ringing tone.

Alert Speaker

The system also has an internal, call-alerting speaker.

On	The internal speaker will warn you of an incoming call even though the monitor may not be switched on.
Off	The internal speaker is switched off.

Key Sound

On	There will be a sound indicator when pressing keys on the remote control.
Off	There will be no sound when pressing keys on the remote control.

4.6 Video



Video contains the settings:

- Camera Tracking Mode
- MCU Status Line
- Floor to Full Screen
- Web Snapshots
- MultiSite Picture Mode
- Picture Control
- Video Name

4.6.1 Camera Tracking Mode

Slow:	The system waits a while before zooming in on a single person speaking. Suitable when wide-angle images are preferred over close-up images.
Normal:	Should be used in regular meetings.
Fast:	The system quickly zooms in on a single person speaking. Suitable when close-ups are preferred over wide-angle images.

Note that the Camera Tracking Mode entry will not be available if not using the WAVE Camera.

4.6.2 MCU Status Line

On	The MultiSite/MCU/DuoVideo indicators will be displayed and provide information about the conference.
Off	The MultiSite/MCU/DuoVideo indicators will not be displayed.
Auto	The MultiSite/MCU/DuoVideo indicators will be displayed for a few seconds and then timed out. When grabbing the remote control, the indicators will be shown again.

4.6.3 Floor to Full Screen

When Floor to Full Screen is enabled, someone who request floor will be seen by all participants as full screen. When Floor to Full Screen is off, someone who requests floor in a multipoint conference using the 5+1 layout will be seen in the large square, rather than full screen.

On:	The participant that has floor is displayed in full screen regardless of what multipoint layout that is used.
Off:	The participant that has floor is displayed in the multipoint layout that is used.

4.6.4 Web Snapshots

The system is able to generate JPEG snapshots and provide them to the world outside by request (as 'http get' or via ftp). See Appendix 6 for descriptions of the possible snapshot files.

On:	Snapshots generation is enabled.
Off:	Snapshots generation is disabled.

Note that web snapshots are not generated if the conference is encrypted.

4.6.5 MultiSite Picture Mode

MultiSite Picture Mode decides the default layout of a multipoint call. Choose between the layouts: Auto Split, Voice Switched, 4 Split and 3 +1 Split. You can change the layout during a call using the layout option in Multipoint Services.

Auto Split	Auto Split displays all participants on the screen simultaneously. A multipoint call with 3 and 4 video participants is displayed with 4 Split. A multipoint call with 5 or 6 video participants is displayed with 5+1 Split.
Voice Switched	Voice Switched mode displays the participant that is speaking in full screen.
4 Split	4 Split displays the 4 last speaking Participants.
3+1 Split	3+1 Split displays the speaking participant in a big picture and the 3 other participants in small pictures.



Continuous Presence layout 4 split



Advanced continuous Presence Layout (3+1)



Voice Switched mode

4.6.6 Picture Control

Focus, Brightness and White balance are set for auto focus, auto brightness and auto white balance by default. If you need to set focus, brightness and white balance manually, go to Picture Control in Video Settings.

Focus

Auto	In Auto mode the focus is continuously updated. When moving the camera, the system will use auto focus for 5 seconds to set the right focus of the new camera position. After 5 seconds auto focus is turned off to prevent continuous focus adjustments of the camera.
Manual	Use the arrow keys to manually adjust the focus.

Brightness

Auto	In Auto mode the brightness is continuously updated.
Manual	Use the arrow keys to manually adjust the brightness.

White balance

Auto	In Auto mode the white balance is continuously updated.
Manual:	To update the white balance manually, select Manual and press OK. A white object should be held in front of the camera a few seconds before and after selecting Manual white balance.

4.6.7 Video Name

As a default, each video input is given the name: Main Cam, PC, Doc Cam, VCR, AUX and VNC. The video names cannot exceed eight characters. The names correspond to the video names in the Presentation Menu (Choose Presentation from the main menu and open the Main Video or Presentation Video pop up menu). If video names are changed, you will see the changed name appear in the Main Video and Presentation Video menus.

4.7 Security



Security contains the settings:

- Encryption
- Encryption Mode
- Passwords

4.7.1 Encryption

(Country specific)

Auto	<p>The system will try to set up calls using encryption.</p> <p>Point to point calls: If the far end system supports encryption (AES or DES), the call will be encrypted. If not, the call will proceed without encryption.</p> <p>MultiSite calls: In order to have encrypted MultiSite calls, all sites must support encryption. The padlock symbol will indicate encryption mode (AES or DES). If there is a mix of AES and DES encryption, only the symbol for DES encryption (single padlock) will be displayed.</p> <p>IP MultiSite calls: Sites supporting encryption will be encrypted and sites not supporting encryption will not be encrypted. The padlock symbol will be shown on the MultiSite if all sites support encryption. The padlock symbol will be shown on the site connected to the MultiSite if this connection to the MultiSite is encrypted.</p> <p>If the far end supports encryption, the systems will initiate encryption after the call is connected (an 'open padlock' symbol will be displayed). When encryption has been established, a 'closed padlock' symbol will be displayed.</p>
-------------	---

On	The system will only send and receive encrypted data. The call will not be established if not all participants support encryption.
Off	The system will not send or receive encrypted data.

Technical encryption information like encryption algorithm and encryption check code can be found in the Call Status menu.

4.7.2 Encryption Mode

Auto	The system will try to use the most secure encryption - AES, dependent on the capabilities of the other sites. If all the other sites do not support AES-encryption, DES encryption will be tried.
AES	The system will try to use AES with 128 bits encryption when setting up calls. If AES is not supported by the other site(s), no other type of encryption will be initiated.
DES	The system will always try to set up the call using DES with 56 bits encryption on ISDN and IP. If all other sites do not support DES, no other type of encryption will be initiated.

Both AES and DES Encryption are supported for mixed ISDN/IP calls. In addition AES -and DES Encrypted sites can be connected at the same time.

4.7.3 Passwords

Administrator Password, IP Access Password, Streaming Password, VNC Password and Access Code are duplicated from their respective menus. Using the Security menu gives you a quick way to change all passwords of the system.

4.8 Network



The network menu contain:

- ISDN-BRI Settings
- LAN Settings
- Network Profiles
- Data Port

4.8.1 ISDN-BRI Settings

To make sure your system will work properly using ISDN-BRI, make the following settings:

1. Set ISDN switch type
2. Enter ISDN line numbers (+ SPIDs if required)
3. Disable unused lines

Some software versions do not support 6 ISDN lines, therefore some of the Line Setup entries may be grayed out.

4.8.1.1 ISDN switch type

Select the type of ISDN network connected to your unit. Note that 1TR6 should only be used if you are operating the system behind a PABX.

4.8.1.2 Line setup

This menu allows you to program the numbers associated with your ISDN line. If you want to use this ISDN line, you need to set Enabled On and enter the numbers of your ISDN line. If some of the ISDN lines are not to be used, set Enabled Off. Line 1 should always be enabled. National ISDN and AT&T Custom ISDN might require SPID numbers associated with your ISDN numbers. If you have received two different SPID (Service Profile Identifier) numbers for each ISDN line from your network provider, you must program both.

<i>Example:</i>		
	Numbers	SPIDS
ISDN BRI 1:	67838498 67838498	016783849800 016783849810
ISDN BRI 2:	23478060 23478070	012347806000 012347807000
ISDN BRI 3:	23478420 23478430	012347842000 012347843000
ISDN BRI 4:	23478520 23478530	012347852000 012347853000

4.8.1.3 Advanced ISDN Settings

Sub address

Using a sub address enables you to connect up to eight ISDN terminals to the same ISDN telephone number and line. The terminals are addressed by using different sub addresses. To call a terminal with a sub address, separate the ISDN telephone number and the sub address with a '*'. Note that this service has limited access on some ISDN networks.

Example: 12345678*2 (up to four digit sub addresses are possible).

Validate Numbers / MSN (Multiple Subscriber Number)

The use of MSN (Multiple Subscriber Number) enables you to attach different ISDN terminals, with different numbers, to the same physical ISDN telephone line. If Validate Numbers is set to On only calls to those numbers specified in the Line Setup menus will be answered. This service can be ordered from your telephone company.

Parallel dial

On	Channels will be dialed and connected in parallel when setting up a BONDING call.
Off	Channels will be dialed one by one, which may increase the dialing time.

Send Own Numbers

On	The system will send its own numbers to the far end.
Off	The system will not send its own numbers to the far end, but please note that the network may still send your numbers to the far end.

Sending Complete

On	The system will send the ISDN message information element Sending Complete.
Off	The system will not send Sending Complete.

4.8.2 LAN Settings

LAN Settings contain:

- IP Settings
- H.323 Settings
- SNMP Settings

4.8.2.1 IP Settings

Remember to restart the system after making changes to IP Settings. Changes in IP Settings menu will not have any effect before the system is restarted.

IP-assignment

DHCP (Dynamic Host Configuration Protocol) can be selected when a DHCP server is present.

DHCP	IP-address, IP-subnet mask and Gateway are not used because the DHCP server assigns these parameters.
Static	The system's IP-address, IP-subnet mask and Gateway must be specified in the IP-address field.

IP-address

IP-address defines the network address of the codec. This address is only used in static mode. In DHCP-mode, the assigned IP-address can be found on the Welcome Menu.

IP-subnet mask

IP-subnet mask defines the type of network. This address is only used in static mode. Your LAN-administrator will provide the correct value for this field.

Gateway

When using DHCP, the default gateway will be set automatically. If the LAN utilizes static IP addresses, IP address, subnet mask, and default gateway must be specified by the LAN administrator.

Ethernet Speed

Auto	The codec will auto-detect the speed/duplex on the LAN.
10/Half	The codec will connect to the LAN using 10Mbps speed/Half Duplex.
10/Full	10 Mbps speed/Full Duplex.
100/Half	100 Mbps speed/Half Duplex.
100/Full	100 Mbps speed/Full Duplex.

IP Access Password

By setting an IP Access Password on the system, all access to the system using IP (Telnet, FTP and WEB) requires a password. The default IP Access Password is "TANDBERG".

4.8.2.2 H.323 Settings**4.8.2.2.1 E.164 alias**

This is the E.164 address of the system. The E.164 address is equivalent to a telephone number, sometimes combined with access codes. Valid characters are 0-9,* and #. When using a gatekeeper, the system will send a message to the gatekeeper containing both the E.164 address and the system name of the system. The system will not register with the gatekeeper if the E.164 alias is not set.

4.8.2.2.2 H.323 Call Setup

Direct	An IP-address must be used in order to make a H.323 call. The system will not use a gatekeeper or call manager
Gatekeeper	The system will use a gatekeeper to make a H.323 call (the system will still be able to place calls directly to an IP-address without using the gatekeeper).
Call Manager	The system will use a call manager to make a H.323 call (the system will still be able to place calls directly to an IP-address without using the call manager).

4.8.2.2.3 Gatekeeper Discovery

Auto	The system will automatically try to register on any available gatekeeper. If a gatekeeper responds to the request sent from the codec within 30 seconds this specific gatekeeper will be used. If no gatekeeper responds, the system will not use a gatekeeper for making H.323 calls and hence an IP-address must be specified manually.
-------------	--

Manual The system will use a specific gatekeeper identified by Gatekeeper IP-address.

4.8.2.2.4 Gatekeeper IP-address

This is the gatekeeper IP-address that is used if you specify H.323 Call Setup: Gatekeeper and Gatekeeper Discovery: Manual.

4.8.2.2.5 Call Manager Address

This is the call manager IP-address that is used if you specify H.323 Call Setup: Call Manager.

4.8.2.2.6 H.323 Prefix

When dialing a number prefixed with digits specified by H.323 Prefix, and with Net: Auto, an H.323 call will be placed.

Example:

H.323 Prefix is "555". Dialing "55582" with "Net:Auto" will select LAN.

4.8.2.2.7 Advanced H.323 Settings

The Advanced H.323 Settings only have an effect if they are supported by your IP infrastructure.

NAT

NAT, Network Address Translation, is used in small LAN's, often home offices, when a PC and a videoconferencing system is connected to a router with NAT support. NAT support in the videoconferencing system enables proper exchange of audio/video data when connected to an external videoconferencing system (when the IP traffic goes through an NAT router). When NAT is On, the NAT Server Address will be shown in the startup-menu: "My IP Address: 10.0.2.1 (NAT)".

NAT Address

This must be the external/global IP-address to the router with NAT support. Packets sent to the router will then be routed to the codec. In the router, the following ports must be routed to the codec's IP-address:

Port 1720
Port 5555-5560
Port 2326-2365

Please contact your TANDBERG representative for further information.

RSVP

Auto	Resource Reservation Protocol enables the systems to request the optimal amount of bandwidth for the duration of an IP videoconference.
Off	Resource Reservation Protocol is switched off.

QoS Type

Off	No QoS is used.
Diffserv	Diffserv QoS method is used. Please see below for details.
IP Precedence	IP Precedence QoS method is used. Please see below for details.

IP Precedence Video

Used to define which priority audio, video, data and signaling should have in the network. The higher the number, the higher the priority. The priority ranges from 0(off) - 7 for each type of packets.

Auto will provide the following priority:

Audio	4
Video	4
Data	3
Signaling	6

IP Type of Service (TOS) helps a router select a routing path when multiple paths are available.

Delay	Tells the router to minimize the delay.
Throughput	Tells the router to maximize the throughput.
Reliability	Tells the router to maximize the reliability.
Cost	Tells the router to minimize the cost.

IP Precedence Telephony

Used to define which priority audio should have in the network for telephone calls. The higher the number, the higher the priority. The priority ranges from 0(off) - 7 for each type of packets.

Auto will provide the following priority:

Audio	4
-------	---

Diffserv Video

Used to define which priority Audio, Video, Data and Signaling packets should have in an IP network. The priority ranges from 0 to 63 for each type of packets.

Diffserv Telephony

Used to define which priority Audio packets should have in an IP network for telephone calls. The priority ranges from 0 to 63 for each type of packets.

H.323 Ports

Static	When selecting static H.323 ports for TCP connections the ports 5555 or 5556 will be used for Q.931 and H.245 respectively.
Dynamic	The system will allocate which ports to use when opening a TCP connection. The reason for doing this is to avoid using the same ports for subsequent calls as some firewall consider this as a sign of attack.

4.8.2.3 SNMP Settings

SNMP Settings

SNMP Trap Host identifies the IP-address of the SNMP manager. SNMP (Simple Network Management Protocol) is used for monitoring and configuring of different entities in a network. The system's SNMP Agent responds to requests from SNMP Managers (a PC program etc.). SNMP traps are generated by the agent to inform the manager about important events.

Traps can be sent to multiple SNMP Trap Hosts. Enter the IP address of up to three SNMP managers. All traps will then be sent to the hosts listed.

SNMP Community names are used to authenticate SNMP requests. SNMP requests must have a 'password' in order to receive a response from the SNMP agent in the codec. Note that the SNMP Community name is case sensitive. The default password is "public".

4.8.3 Network Profiles

This menu consists of 6 network profiles; a prefix can be added for each profile. If you add a prefix to a profile, this prefix will automatically be added in front of the number being dialed.

Example:

0 is added as a Call Prefix to the 2nd profile, ISDN. If you enter 12345678 in the dial menu and select ISDN, the number dialed will be 012345678.

Using the three last profiles you can enter the name of a profile, prefix and network selection. This is useful if you have a fixed prefix for your service provider.

4.8.4 Data Port

The system provides two standard RS232 serial ports to allow a computer to be connected for data transfer and control purposes. Note that when connecting to a PC the connecting cable must be a straight through RS232 cable.

Baud Rate, Parity, Databits and Stopbits

If you wish to connect a PC to Data port 1, you must ensure that the PC and the system are identically configured. The available settings are:

Baud Rate	1200, 2400, 4800, 9600, 19200, 38400, 57600, 115200
Parity	None, Odd, Even
Databits	7, 8
Stopbits	1, 2

Mode

Data port 1 supports 3 different modes:

Data	Provides a transparent data channel. This channel can be used for many different purposes such as file transfer, application sharing and more. When using this mode, it is necessary to have a TANDBERG system at the far end.
Control	The control interface provided by the data port supports a subset of the Hayes command set as well as a comprehensive set of system specific commands. This mode maintains communication with the data port's command interpreter at all times. All features available from the hand-held remote control can be accessed through the data port.
Modem	Allows you to control the system externally via a PC as in Control Mode. Once a call is established, Data port 1 will automatically switch to Data mode. When the call disconnects, Data port 1 switches back to Control Mode.

4.9 Diagnostics

Diagnostics allows testing of individual system components and displays the current system settings.



Diagnostics contain:

- System Information
- Call Status
- Channel Status
- System Selftest
- View Administrator Settings
- Restore Default Settings
- IP Address Conflict Check

4.9.1 System Information

Select System Information to view system numbers, line status, software version and other useful information.

System Information contains:

System Name	Software Version	Network	Hardware Serial Number
My ISDN Number	Internal Test	Lines active	MAC address
My IP Number	Software	Lines not active	Ethernet Speed
My IP Address	Options installed		
MultiSite number 2			
MultiSite number 3			

4.9.2 Call Status

Comprehensive information about the call is available through the Call Status window. The menu has two columns, one for transmitted and one for received audio/video/data information. If Duo Video or MultiSite is used, pressing the UP/DOWN keys will show one page per connected site. Some of the information fields will vary dependent on if H.320 (ISDN calls) or H.323 (IP calls) are made.

4.9.3 Channel Status

Comprehensive information about the call progress is available through the Channel Status window. This window indicates the various stages each B-channel goes through whilst establishing a connection.

Status - BRI	Comments
Idle	the channel is idle
Calling	when calling — the network has acknowledged the call
Connected	when connection is established
Sync	when the channels are synchronized
Active	when all available channels are connected
Releasing	waiting for the network to confirm a release of the call
Released	when disconnected - the network has acknowledged the disconnection

Cause codes

The most common cause codes (for ISDN) are:

1	Unallocated (unassigned) number
2	No route to specified transit network (WAN)
16	Normal clearing
17	User busy
18	No user responding
21	Call rejected
28	Invalid number format (incomplete number)
29	Facility rejected
31	Normal, unspecified
34	No circuit/channel available
41	Temporary failure
58	Bearer capability not presently available
65	Bearer service not implemented
69	Requested facility not implemented
81	Invalid call reference value
88	Incompatible destination
100	Invalid information element contents
102	Recovery on timer expiry
127	Internetworking, unspecified
255	TANDBERG specific. undefined cause code

PRI Red Alarm

Red alarm or Loss of signal (LOS) means that there is no signal and thus no framing info received (this has same effect as pulling out the PRI cable).

PRI Yellow Alarm

Yellow alarm or Remote Alarm Indicator (RAI) means that the system is receiving framing info, but in this framing info the other side tells the system that it is not reading the system's transmitted framing info. Typically, this may be a broken connector in the TX part of the system PRI cable. This could also indicate weak or noisy signal in the TX part of the system PRI cable.

PRI Blue Alarm

Blue alarm means that network on the far side of the CSU is unavailable.

Example:

*The system is connected via a CSU (i.e. a NT 'Network Termination') as follows:
System–cableA–CSU–cableB–Network*

If a CSU loses framing/sync from the network (example: a bad cable B), it shall no longer send valid framing out on cable A towards the system. Instead it transmits "Blue Alarm". Seen from a system receiving blue alarm, this means that the network on the far side of the CSU is unavailable.

4.9.4 System Selftest

The system performs a check to determine internal hardware integrity. System Selftest is useful when you want to check if your network connection is active.

4.9.5 View Administrator Settings

This window displays all the system settings. Use the arrow key on the remote control to scroll through the list.

View Administrator Settings contain:

General Settings

- System Name
- Language
- Dual Monitor
- Auto answer
- Max Call Length
- Access Code
- Incoming MCU calls
- Incoming Telephone calls
- Far End Control
- Fallback to Telephony

Screen Settings	TV Monitor Format Picture Layout VGA Monitor Format VGA Out Quality PC Picture Format Allow VGA 50Hz
Software Options	Options Installed Hardware Serial Number Current Option Key
Menu Settings	Menu Timeout in Call Welcome Menu Welcome Picture Logo Display Welcome Text Welcome Text Administrator Password
Presentation Settings	Duo Video Mode Start up Video Source Presentation Source Snapshot Source Auto Display Snapshot PIP Appearance PIP Placing
VNC Settings	Address Display Number Call Quality Video Algorithm Audio Algorithm Interlaced
Video Quality	Main Camera PC (VGA) PC (VNC) Document Camera VCR AUX VNC Split Screen
Default Call Settings	Call Type Network Bandwidth Restrict (56k) Auto H320 Bandwidth Auto H323 Bandwidth
Audio Settings Inputs	Mic1 Mic2 Mic3 Audio4 Audio5 Audio6 Mix Mode
Outputs	Out1 Out2 (AUX) Out3 (VCR) Audio Module
Echo Control	Mic1 Mic2 Mic3

	Audio4
Audio Leveling (AGC)	Mic1-3, Audio4 Audio5 (AUX) Audio6 (VCR) Received Audio
Alert Tones & Volume	Video Call Alert Tone Telephone Alert Tone Alert Speaker Key Tones
Video Settings	Camera Tracking Mode MCU Status Line Web Snapshot MultiSite Picture Mode
Picture Control	Focus White balance Brightness
Video Name	Main Cam AUX Doc Cam VCR PC VGA VNC
Network Type	ISDN-BRI\PRI\Leased E1\T1\External H331 ISDN Switch Type ETSI (Euro ISDN),... Line1 Setup On Number1 Number2 SPID1 SPID2 Line2 Setup On Number1 Number2 SPID1 SPID2 Line3 Setup On Number1 Number2 SPID1 SPID2
Advanced ISDN Settings	Subaddress Validate Numbers (MSN) Parallel Dial Send Own Numbers Sending Complete
ISDN-PRI Settings	Number Range ISDN-PRI Switch Type
Channel Hunting	Max Channels Low Channel High Channel Search High, Low Line Settings: T1 Cable Length 1 T2 Cable Length 2 E1 CRC-4
Advanced ISDN PRI Settings	NSF Code Video

	NSF Code Telephone Call
Leased E1/T1 Settings	Call Control Network Interface Max Channels Start Channels T1 Line Coding Line Settings
External network configuration	Call Control RS66 RS449/V.35 Compatible
IP Settings	IP assignment IP address IP subnet mask Gateway Ethernet Speed
H.323 Settings	E.164 Alias Use Gatekeeper Gatekeeper IP H.323 Prefix
Advanced H.323 Settings	RSVP NAT NAT Address QoS
IP Precedence	Audio Video Data Signaling IP Type of Service (TOS)
Diffserv	Audio Video Data Signaling
SNMP Settings	SNMP Trap Host1 SNMP Trap Host2 SNMP Trap Host3 SNMP Community
Streaming Settings	Address Address Port TTL/Router Hops Streaming Source Allow Remote Start Announcements Video rate (kbps)
Network Profiles	Auto 2H.320 H.323 Network Profile 4 Network Profile 5 Network Profile 6
Security	Encryption Encryption mode
Data Port 1	Baud rate Parity Databits Stopbits Mode
Data Port 2	Baud rate

	Parity
	Databits
	Stopbits
	Mode

4.9.6 Restore Default Settings

Restore Default Settings will restore all administrator settings. Note that this will not affect your Call Directory information, Network Type, Line Setup numbers or your SPID numbers.

4.9.7 IP Address Conflict Check

The system will give a warning if there is an IP conflict. The user may initiate this check by selecting IP Address Conflict Check.

5 Peripheral Equipment

Using the optional peripheral devices outlined in this chapter and the many others available, you will be able to build your own applications for use with the system, thereby better integrating the system into your business environment. This chapter will explain how to connect peripheral equipment to your system. First of all however, we recommend you examine the figure below detailing the available connectors on the back of the system Codec.

Peripheral Equipment contain:

- Interfaces
- Document Camera
- Video Cassette Recorder (VCR)
- Telephone Add-On
- Additional Cameras
- Additional Microphones
- Web Interface
- Dual Monitor
- XGA Monitors and Projectors
- VESA Display Power Management
- Extended Display Identification

5.1 Interfaces

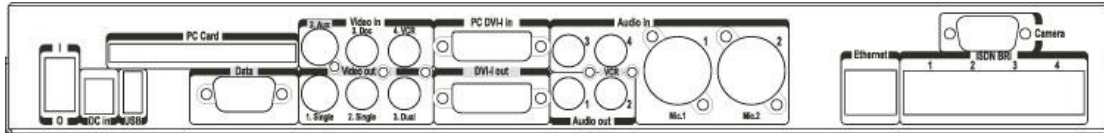

5 Video Inputs

- 1 video input used by the camera.
- 1 video input supporting S-Video through a Mini-DIN connector.
- 2 video inputs supporting composite signals through RCA connectors.
- 1 VGA/DVI-I (DVI = Digital Video Interface, I = Integrated Digital & Analog) input supporting resolutions VGA (640x480), SVGA (800x600), XGA (1024x768) and SXGA (1280x1024), analog or digital.

The system will automatically adapt to a PAL or NTSC input.

4 Video Outputs

- 1 S-Video output, Mini-DIN connector.
- 2 composite video outputs, RCA connectors.
- 1 VGA/DVI-I (DVI = Digital Video Interface, I = Integrated Digital & Analog) output supporting resolutions SVGA (800x600) and XGA (1024x768, analog or digital).

The first Mini-DIN connector and the first RCA connector provide main video (incoming/outgoing video and menus).

The other connector provide selfview/still image/Duo Video. The outputs are always active. The format of the output will be either PAL or NTSC depending on your country's standard video format.

The VGA/DVI output provides either main monitor video or second monitor video depending on menu configuration.

VGA formats supported on 'DVI-I out':

SVGA (800x600) 75 Hz

XGA (1024x768) 60 Hz

4 Audio Inputs

- 2 microphone inputs (balanced, 11V phantom powered) via XLR connectors.
- 2 audio inputs (line level) via RCA connectors.

All audio inputs are active by default. For further information, refer to section 'Audio Settings'.

2 Audio Outputs

- 1 output (line level) via RCA connector providing audio from far end in addition to dial tones. This output is used by the monitor. This output also supports S/PDIF.
- 1 VCR output (line level) via RCA connector providing a mixed signal between audio from the local side (except from the VCR input) and audio from the far end. This output is intended for connection to a VCR.

5.2 Document Camera

A document camera can be used for showing text, diagrams and a variety of graphical material as well as small three-dimensional objects.

How to use a document camera with your system:

1. Connect the document camera to the Doc Cam input on the system.
2. Open the Presentation menu from Main menu and choose Doc Cam.
3. You can also program the Presentation key on the remote to activate document camera. See chapter 3.11.1 Presentation Key for more information.

If you want to use S-Video from the document camera, you can connect the document camera to the AUX input on the system.



5.3 Video Cassette Recorder (VCR)

VCR/DVD - Playback

Mono

For playback, connect a cable between Video Out on the VCR and Video In (VCR) on the system. Connect a cable between Audio Out on the VCR and the Audio In (VCR) on the system. Choose VCR from the Presentation menu to activate the VCR input.

Make sure that Audio In (VCR) is On (see chapter 4.5 Audio). If audio from VCR is too low, this level can be adjusted in Audio Settings, Inputs, Level Settings. The audio from the VCR will be audible in the local speaker system.

The audio from the VCR and your microphone(s) will be mixed and sent to the far end. When a person talks on either local or far end, the VCR audio level will be reduced to make it easier to comment on a video recording when Audio Settings, Mix Mode: Auto.

Stereo

For stereo playback, connect:

- Video cable between Video Out on the VCR and Video In (VCR) on the system
- Audio cable between Audio Out (L) on the VCR/DVD and the Audio In 3(VCR L)
- Audio cable between Audio Out (R) on the VCR/DVD and Audio In4 (VCR R)
- Choose the VCR video source (see chapter 3.11.2 Presentation menu) to automatically activate the VCR audio and video input.

Make sure that:

- Stereo Input Mode is set to On (see chapter 4.5.4 Stereo Settings)
- 128 AAC-LD is enabled (see chapter 4.4.3 AAC-LD 128 kbps)
- AAC-LD is enabled (see chapter 4.4.2 Audio Algorithm)
- Audio In (VCR) is On (see chapter 4.5 Audio). If audio from VCR is too low, this level can be adjusted in Audio Settings, Inputs, Level Settings. The audio from the VCR will be audible in the local speaker system.
- To enable VCR/DVD ducking (reduce volume when speaking), check that Mix Mode under Audio Settings is set to Auto.

Note that the audio from the VCR/DVD and your microphone(s) will be mixed and sent to the far end. When a person talks on either local or far end, the VCR/DVD audio level will automatically be reduced to make it easier to comment on a video recording (when Audio Settings, Mix Mode: Auto).

VCR - Recording

When recording, the VCR will record the video as it appears on the main monitor, the local audio and the audio from the far end.

When recording a videoconference, connect a cable between Video Out 2 on the system and Video In on the VCR. Connect a cable between Audio Out 2 on the system and Audio In on the VCR.

5.4 Telephone Add-On

The system have a built in audio bridge* that can bring in Voice over IP (VoIP) telephony or normal telephone sites using ISDN. It can bridge upto 3 telephony sites in any mix.

In addition to using ISDN and IP for your telephone sites, there are possible to connect a telephone using normal POTS line** by

- Connect the audio out from the conference telephone to audio input 3 (AUX)
- Connect the audio input from the conference telephone to audio output 2, which provides a mixed signal between local and far end.

*optional MultiSite package available (not on TANDBERG 770)

** require a conference phone with external audio input and output

5.5 Additional Cameras

Extra fixed Cameras

You can connect extra fixed cameras to your system, for example, a whiteboard camera. Connect the video output of the additional camera to one of the available Video inputs on the system.

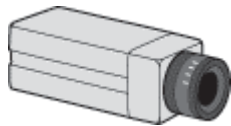

5.6 Additional Microphones

If your environment is such that you require more than one microphone for your room, e.g. you have a whiteboard at a distance from your table microphone; it is possible to connect additional microphones to your system. See Appendix 5 for more information.

If your environment is such that you require more microphones for your room, e.g. you have a whiteboard at a distance from your table microphones, it is possible to connect additional microphones to your system. You can connect two microphones to your system. The connectors are marked Mic1, Mic2. The connected microphones will by default be mixed.

When more than one microphone is connected, you have the option to use the Voice Activate Camera Tracking feature.

5.7 Web Interface

It is possible to access and maintain the system remotely via a local area network (LAN) using a standard Web-browser. Connect your system to a LAN with a Network cable.

How to configure your system for web interface:

1. Open Administrator Settings and choose Network\LAN Settings
2. Specify IP-assignment DHCP or Static. If DHCP is selected, no other settings are needed. If Static is selected, IP-address, IP-subnet mask and Gateway must be specified.
3. Start your Web-browser. In the address field type the IP-address of the system. Enter the password and the Web-page of the system will be shown. The default password is TANDBERG.
4. Restart the system. Choose Restart from the Control Panel.

Example:

IP-assignment:	Static
IP-address:	196.9.200.129
IP-subnet mask:	255.255.255.0
Gateway:	196.9.200.21

See chapter 4.8.2 LAN Settings for further information.

5.8 Dual Monitor

It is possible to install the system in a Dual Monitor configuration. The Dual Monitor can be used to show full screen selfview, still images and Duo Video.

To use the system in the Dual Monitor configuration:

1. Connect "Video Out 3" (composite video output) on the system to a video input on the dual monitor.
2. Set "Dual Monitor: On" in General Settings menu.

Alternatively you can use a PC monitor as your second monitor:

1. Connect "DVI-I out" on the system to your PC monitor.

5.9 XGA Monitors and Projectors

(Optional)

The system can be delivered with optional single or dual TV/XGA monitors. It can also be connected to any DVI/VGA/PAL or NTSC display.

Note that the unit supports VESA Display Power Management on the DVI/VGA output (see chapter 5.10 VESA Display Power Management) and can be used to put your VGA monitors/projectors to standby when the system goes into screensaver mode.`

5.10 VESA Display Power Management

Because of the tremendous amount of energy consumed by monitors when operating, the system will reduce power consumption and extend monitor lifecycle by suspend (switch off) monitors and projectors when the system goes into sleep/standby.

This apply for all VESA Display Power Management comlient displays that are connected to the VGA/DVI output of the system

Note that this requires the display device to comply with VESA display Power Management system.

5.11 Extended Display Identification Data (EDID)

Extended Display Identification Data (EDID) is a VESA standard data format that will allow the system to communicate its capabilities, including vendor information like the supported VGA-formats and frequency range limits to a PC connected to the XGA/DVI input.

This means that the PC always* will be able to output a valid VGA/DVI signal to the system with no manual reconfiguration of the PC screen settings.

*Need to comply with the VESA EDID standard

6 Appendix

Appendixes:

- Appendix 1: Connecting the system to ISDN using NT1 network adapters
- Appendix 2: Connecting the system to the Switched 56 network
- Appendix 3: Connecting the system to PRI/T1
- Appendix 4: Environmental considerations
- Appendix 5: Guidelines for setting up videoconferencing rooms
- Appendix 6: Using the file system
- Appendix 7: Security
- Appendix 8: Pinouts and Connectors
- Appendix 9: Cisco CallManager registration
- Appendix 10: Diagnostic Tools for IP
- Appendix 11: Declaration of Conformity

6.1 Appendix 1

Connecting the system to ISDN using NT1 network adapters

Connecting

Connect the first ISDN cable from ISDN 1 on the system to the S-interface on your first NT1 network adapter. Connect the other ISDN cables to the appropriate NT1 network adapters. Connect the U-interface of your NT1 adapter to the line provided from your network provider.

For convenience the NT1 adapters could be placed inside the cabinet. If needed, use the shorter ISDN cable (RJ45 connectors) delivered with the NT1 between the codec and the NT1 and the longer ISDN cable between the NT1 and the connector (RJ45) at the wall socket.

Configuring

The configuration of the system is performed in the same manner as described in ISDN BRI Settings.

The NT1 should be powered up and you should check that the network is active. Please check your NT1 User Manual.

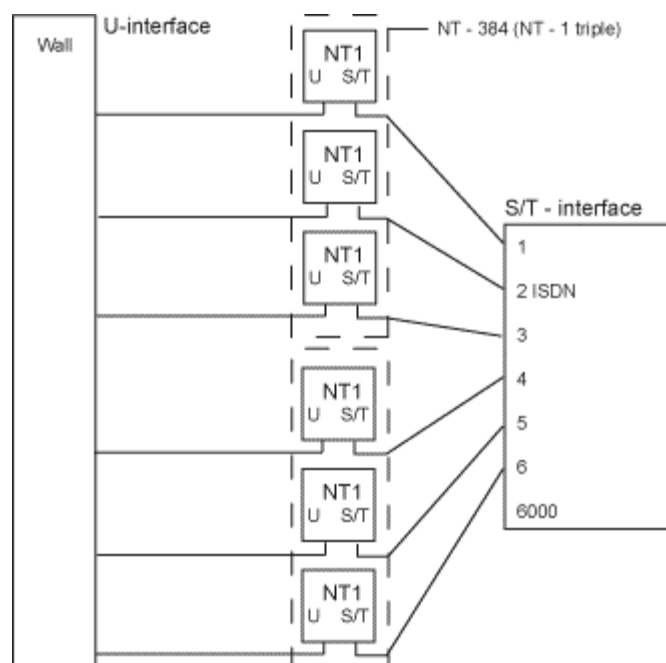

6.2 Appendix 2

Connecting the system to the Switched 56 network

Using Telesync TS-256 SW56/ISDN adapter

Connecting the system to the SW56 network using a Telesync Adapter is described below. There are different Telesync Adapters for different configurations of SW56 networks. The network types tested with the system are SW56 2Wire and 4Wire.

Connecting

Connect the system ISDN1 cable to the BRI S/T interface on the Telesync Adapter. Connect the two SW56 cables from the Telesync adapter Line 1 and Line 2 to the SW56 network.

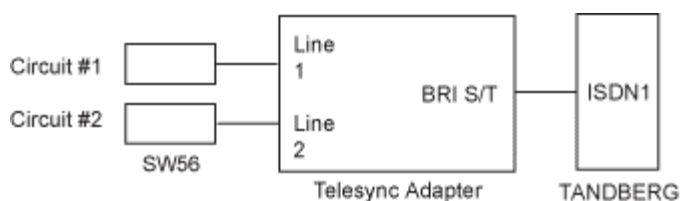

Configuration of the system

Select network type to National ISDN.

LINE 1 SETUP

NUMBER1: program with number from the first SW56 line
 NUMBER2: program with number from the second SW56 line
 SPID1: program with number from the first SW56 line
 SPID2: Leave blank

How to call

It is important to use Restrict (56k). Select Restrict (56k) in Call Settings in the Call menu (select the field next to the phone book button in the call menu). A second number field will appear when ISDN is selected for Net within Call Settings and you choose bandwidth 128 kbps. Enter the second number in the call settings menu.

6.3 Appendix 3

Connecting the system to PRI/T1

Using CSU adapter

Connecting the system to the ISDN network via the E1/T1-interface using an Adtran T1 ESF CSU ACE or equivalent CSU, will allow up to 1.54 Mbps connection. The E1/T1-interface must be connected to a CSU approved according to IEC 60950, UL 1950 or equivalent standard. The PRI-line will run the AT&T 4ESS, 5ESS and National ISDN protocols in addition to Euro ISDN (E1).

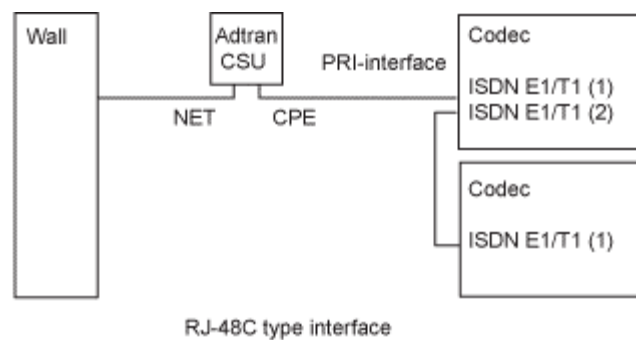

Connecting to Adtran T1 ESF CSU ACE

Connect the PRI cable from the system to the input marked CPE (Customer Provided Equipment) on the Adtran CSU (straight through category 5 cable is recommended). Connect to the network via the NET connector on the Adtran CSU. When two systems are cascaded, connect the second system to the E1/T1 port 2 on the first system using a T1 crossover cable.

Configuration of the system

Open the Administrator Settings Menu from the Control Panel and select Network. Choose Network Type: PRI and specify your PRI number, max. Channels, cable length (between system and CSU) and switch type.

Configuration of Adtran T1 ESF CSU ACE

- Enter 2)CONFIG menu using SCROLL and ENTER buttons.
- Enter 3)TERMINAL menu. Check 1)FORMAT:ESF, 2)CODE: B8ZS , 3)SET LBO: 0-133 (corresponding to Cable Length setting on the system).
- Go to main menu and enter 1)NETWORK menu. 7)SET LBO: 0.0 (according to information from Telco).
- Also, other network parameters should be set according to information from your Telco.

Note! Cascaded connection: Remember to program numbers and MSN. Otherwise, the first system will answer all calls.

6.4 Appendix 4

Environmental considerations

This section explains how to carry out basic adjustments and simple tests to ensure that you send and receive the best possible image and audio quality when using your system.

Iris control and lighting

By default the system camera will use an automatic iris to compensate for changes in lighting. In addition to this feature, you may further assist the system to maintain the best possible image quality by paying special attention to environmental lighting and background colors as described below. Remember the system will send live images of yourself *and* your immediate surroundings.

- Avoid direct sunlight on the subject matter i.e. yourself, the background or onto the camera lens as this will create harsh contrasts.
- If light levels are too low you may need to consider using artificial lighting. As described above, direct illumination of the subject matter and camera lens should be avoided.
- When using artificial lighting, daylight type lamps will produce the most effective results. Avoid colored lighting.
- Indirect light from shaded sources or reflected light from pale walls often produces excellent results.
- Avoid harsh side lighting or strong light from above. Strong sunlight from a window or skylight may put part or all of the subject matter in shadow or cause silhouetting.
- If you still have problems with the iris and lighting, manual adjustment of the camera parameters might help – see Video Settings menu.
- Dim scenes can also be improved by manually adjusting the camera brightness setting.

Background

The appearance of the picture background is very important but easily overlooked. It is important to remember that the camera also shows what is behind you when in a videoconference. To ensure a suitable background we recommend you consider the following:

- Use a neutrally colored background with a medium contrast and a soft texture, e.g. a plain curtain with no heavy patterns or strong colors that may adversely tint the whole scene.
- Avoid moving backgrounds such as curtains blowing in a draught, moving objects, or people walking behind as this may both reduce image quality and distract the attention of the calling party.
- Do not place the camera facing a doorway.

Loudspeaker volume

The audio system will use the Digital Natural Audio Module (DNAM). The volume of the audio system is controlled by the Volume Control keys on the system remote control.

6.5 Appendix 5

Guidelines for setting up videoconferencing rooms

The following are a set of guidelines to consider when either building a videoconferencing room, or using an existing room for videoconferencing.

Lighting:

- Low Contrast desired for light intensity. No dark spots.
- Intensity @ table 800 - 1400 Lux as measured with an Incident light meter.
- Block sunlight from entering room.

Seating Area (Table):

- Should allow all participants to see Monitors.
- Should allow camera to “see” all participants.
- Non-shiny non-patterned preferably light grey surface (if table used).

Walls:

- Color: Generally high contrast color desired. Light blue is commonly used.
- Acoustically reflective surfaces (such as glass or concrete) should be covered with curtains or sound treatment.

Audio:

- Noise Floor preferred less than 44dBC.
- Reverb Time 0,3 to 0,5 sec.

Ventilation:

- Keep in mind Noise Floor.
- Velocity = Noise. Therefore keep velocity of air low.

Room:

- Should be located away from noise.
- Should not have windows.
- Doors should be located off camera.

How to prepare a typical room for videoconferencing:

The diagram below shows a typical room designed to obtain the best results when using the system.

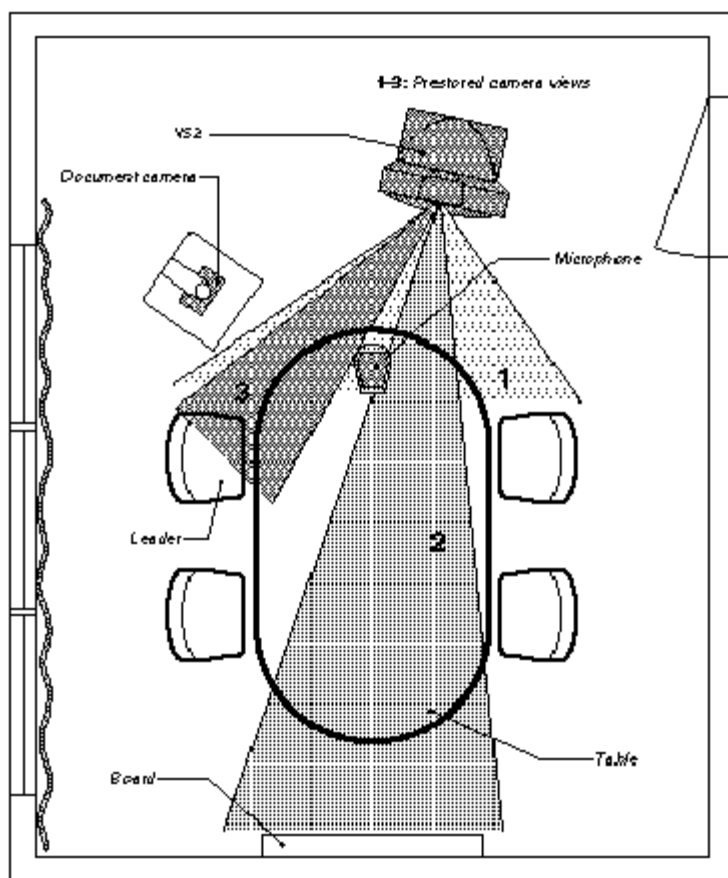

The microphone should be placed at the front of the table to ensure that all speech will be detected. The best position for the microphone is at least 2 meters (6.5 feet) in front of the system on a plain, flat table with at least 0.3 meters (12 inches) of table in front of the microphone.

The document camera should be close to the chair person or a designated controller of the document camera for ease of use (remember to arrange all the peripherals so that one participant can reach each of them to point, change the display, tape, and so forth).

The camera supports up to 15 pre-stored camera positions.

The illustration shows three possible camera positions; one for all the participants, one for the whiteboard and one for the main speaker. The remaining camera presets are then available for other peripheral equipment, for example a VCR.

Position the system in such a way as to avoid the possibility of somebody inadvertently walking into the camera's field of view when entering the room. Other than the conference participants, there should be no moving items in the sent image.

6.6 Appendix 6

Using the file system

It is possible to access a file system within the TANDBERG system by using ftp:

DOS-window:	ftp <IP-address of system>, or
Web-browser:	ftp:// <IP-address of system>

Description of the different files:

all.prm	all settings in the system (including directory)
dir.prm	directory entries (up to 200 entries)
event.log	logs fault situations etc.
sw.pkg	the system software
globdir.prm	file containing up to 400 entries. These entries can not be edited from the system, but can be edited as a text-file.

Files accessible only by 'ftp get /tmp/snapshots/xxx.jpg' or 'http://<IP-address of system>/tmp/snapshots/xxx.jpg':

main.jpg	Snapshot of current stream if MultiSite.
local.jpg	Snapshot of selfview.
farend.jpg	Snapshot of decoded stream if point-to-point.
duovideo.jpg	Snapshot of the encoded stream if transmitting DuoVideo, the decoded stream if receiving DuoVideo.

Description of the different folders

user	a folder to be used for custom logos etc.
remote	a folder used for software upgrade of the far end TANDBERG system.

What can be done by using the file system?

- upload of custom logos

Software upgrade

- Connect to the system you want to upgrade using ISDN.
- Copy the software file to a folder on your harddisk.
- Open a DOS-window and go to this folder.
- Type ftp <IP-address of your local system>).

- Enter password: <Release Key of far end system>
- Go to the remote folder, type "cd remote"
- Upload the software file, type put <s0xxxxxx.pkg>
- Wait until the following is shown:

```
226 Closing data connection.  
5437569 bytes sent in 808.01 seconds (6.73 Kbytes/sec)  
ftp>
```
- Restart the far end system.

The far end system should now be upgraded. For further information, please contact your TANDBERG representative.

Custom logos

- Go to the folder where your logo is located.
- Type "ftp <IP-address of your local system>".
- Go to the user folder, type "cd user".
- Upload the logo, type "put <startup.jpg>".

The new logo will be displayed the next time you restart your system. Logo max size: E2 and above: 704x480, B7 and above: 320x200, file-format: jpg. If the file is too large, no logo will be displayed.

6.7 Appendix 7

Security

The system has several features both to protect from unauthorized use and system access:

Access Code:

When Access Code is enabled, the user will be asked to enter an access code before he/she is able to make a call. The system will verify if the entered access code is valid by checking the code with the allowed codes listed in the access.txt file on the ftp-server in the system. If no access.txt file is uploaded to the system, registration of the code will be done without validation. E.g. you can enter whatever code you want and have access to the system.

The access.txt file is a plain text file with one line per access code as shown below:

```
1234
1250
A1
B2
ABC
```

To upload this file to the system, follow these steps:

- Open a DOS-window and go to the folder where the 'access.txt' file is located.
- Type ftp <IP-address of your local system>.
- User: press Enter or enter IP-password.
- Type "bin" and press Enter.
- Go to the user folder, type "cd user".
- Upload the 'access.txt' file, type 'put access.txt'.
- Exit from ftp, type "bye".

Administrator Password

Access to the administrator menu on the system unit can be controlled using password protection. You can set the Administrator Password in Menu Settings, in Security or from the dataport:

menupassword set <pin-code>. The pin-code should be maximum 5 - five digits. To erase the password, enter an empty pin-code.

Streaming password

By setting a streaming password in the streaming menu on the system, a password has to be entered on the streaming client to be able to see the videostream from the system.

IP Password

By setting an IP Access Password on the system, all access to the system using IP (Telnet, FTP and WEB) requires a password. This password can be enabled from telnet or dataport using the command: ippassword <ip-password>. The default IP password is "TANDBERG".

To remove this password, use the command: "ippassword ". From telnet, this is only possible by first entering the correct password.

Services

The different IP services on the system - FTP, Telnet, Telnet Challenge, HTTP, HTTPS, SNMP and H.323 can be disabled to prevent access to the system. By using the commands below, the services can be independently enabled/disabled:

```
services <telnet/telnet challenge/ftp/http/https/h323/remote-parameter/remote-software>  
<enable/disable>  
services <snmp> <read-only/enable/disable>  
services <telnetchallenge> <enable/disable> [port]
```

SNMP Security alert

This function will notify any Management Application (such as TMS - TANDBERG Management Suite) if anyone tries to perform Remote Management on the system using an illegal password. The Security alert that is sent to the Management Application will contain information about the IP address and the service (WEB, Telnet, FTP) being used for the attempt. If TMS is used, email notifications or alarms about the attempt can be sent to specified persons.

Encryption

All TANDBERG systems support both AES and DES encryption. By default this feature is enabled such that when connecting with any other video system or MCU, a TANDBERG system will attempt to establish a secure conference using AES or DES encryption. The TANDBERG system will attempt this for both IP and ISDN connections. Where a remote system or MCU supports encryption, the highest common encryption algorithm will be selected on a port-by-port basis.

The type and status of the encryption negotiated is indicated by padlock symbols and on-screen messages. Encryption on the TANDBERG systems is fully automatic, and provides clear security status indicators;

- An open padlock indicates that encryption is being initialized, but the conference is not yet encrypted.
- Single padlock indicates DES encryption.
- Double padlock indicates AES encryption.

In addition to on-screen indicators the Call Status menu provides two information fields regarding call encryption. The first field is the Encryption Code, which will identify either AES or DES. The second field is the Encryption Check Code and is comprised of an alphanumeric string. This string will be the same for systems on either side of an encrypted conference. If the Check Codes do not match, this would indicate that the call has been exposed to a Man In The Middle attack.

When a system with MultiSite functionality hosts a conference, the highest possible encryption algorithm will be negotiated on a site-by-site basis. MultiSite conferences can therefore support a mix of AES and DES encrypted endpoints in the same conference. A conference will only be as secure as its weakest link. Even though conference participants may have negotiated and are running AES encryption, if just one participant has negotiated DES encryption, the AES system will display the single padlock symbol to advise all users of the lowest encryption mechanism currently in effect.

All systems supporting DES encryption can upgrade to AES encryption. Please contact your TANDBERG representative for more information. The standards supporting the encryption mechanisms employed by TANDBERG are: AES, DES, H.233, H234 and H.235 (H235v3 & v2 for backwards compatibility) with extended Diffie Hellman key distribution via H.320, H.323 and Leased Line connections.

The TANDBERG AES implementation is validated as conforming to the Advanced Encryption Standard (AES) Algorithm, as specified in Federal Information Processing Standard Publication 197, *Advanced Encryption Standard*, by The National Institute of Standards and Technology (NIST).

6.8 Appendix 8

(Not for set top systems)

Pinouts and Connectors

WAVE II Camera:

8-PIN RJ (shielded modular jack):

This connector is used for the power and control signals to the main camera.

Pin-8	+12V (presence when connected in daisy chain)
Pin-7	GND
Pin-6	GND
Pin-5	RXD (in)
Pin-4	TXD (out)
Pin-3	+12V
Pin-2	GND
Pin-1	+ 12V

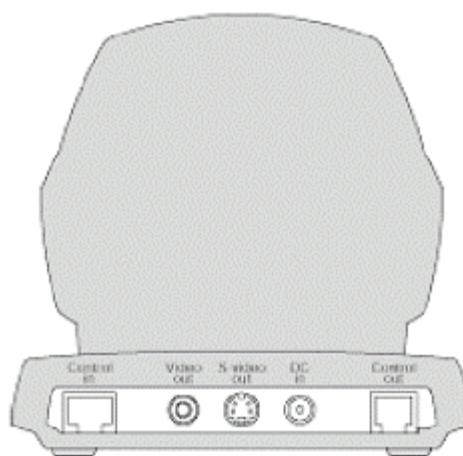

Standard Phono:

Used for composite video signal

Power:

2.0 mm DC power jack (+12V, 1A required)

Standard Mini Din:

Used for S-Video signal

6-PIN RJ (modular jack):

This connector is used when cascading cameras: Control (out) signal and external camera detection. Note: It does not provide power for cascaded camera.

Pin-6	GND
Pin-5	GND
Pin-4	RXD (in)
Pin-3	TXD (out)
Pin-2	Presence (+12V in daisy chain)
Pin-1	GND

Multiple Camera support:

The figure below is an example of how multiple cameras should be connected:

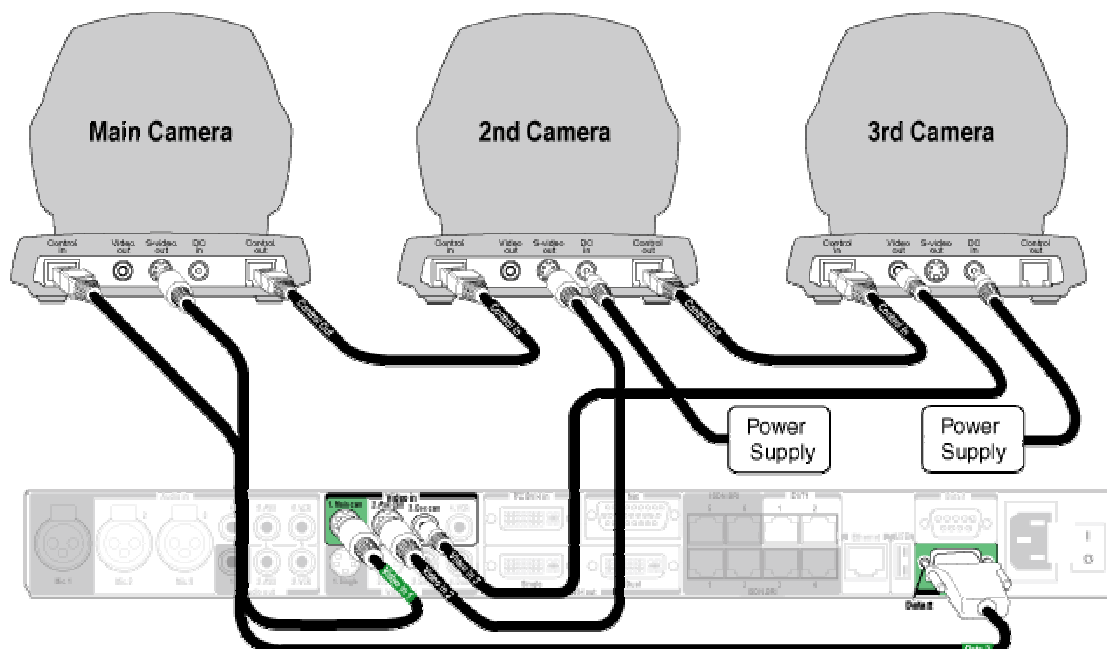

Ethernet:

To connect the system to a LAN, use the Ethernet cable provided by TANDBERG (or a standard Ethernet cable). If no LAN is available and the codec is connected directly to a computer, use a crossover cable.

The crossover cable specification is:

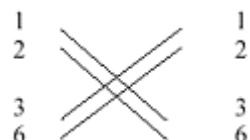

If such a connection is needed, the system and the PC must use 'static' TCP/IP settings because no DHCP server is controlling the small "LAN", which has been created between the computer and the system. When configuring a back-to-back connection between the PC and the system, make sure both static IP addresses exist on the same subnet.

BRI ISDN Interface:

To connect the system to BRI, use the ISDN cable provided by TANDBERG (or a standard BRI cable).

The pinout of the S/T interface is:

Pin-3	TX+
Pin-4	RX+
Pin-5	RX-
Pin-6	TX-

PRI ISDN Interface:

To connect the system to PRI, use the ISDN cable provided by TANDBERG (or a standard PRI cable).

The pinout of the E1/T1 interface is:

Pin-1	TIP RX
Pin-2	RING RX
Pin-4	RING TX
Pin-5	TIP TX

6.9 Appendix 9

Cisco CallManager registration

Configuring an H.323 client on the CallManager 4.0

The registration of a H.323 client in CallManager is supported on the CallManager (CCM) 4.0 software and forward.

1. To configure the CallManager with an H.323 client, log on to the administration web interface and go to the phone configuration page.
2. The Phone configuration page is located on: device (top menu) -> Add a New device -> Phone -> H.323 Client.
3. In the phone configuration page type the IP address of the TANDBERG system in the Device name field, select device pool and push the insert button.
4. A pop-up box will now appear on the screen and ask you if you would like to configure the directory number. Push the ok button.
5. You should now see the Directory Number Configuration WEB page. Enter the E.164/phone number of your TANDBERG system in the Directory number field, and in the "Forward and Pickup Settings" enter the time of "No Answer Ring Duration". The time selected has to have a value from 1 to 300 seconds.
6. Push the Add button to update the CallManager with the directory number settings.

You have now configured the CallManager with a H.323 client and should be able to register the TANDBERG system to it. When the TANDBERG system is registered to a CallManager, it will be possible to place and receive calls from this system to any other video and voice systems that are registered on the same CallManager.

6.10 Appendix 10

Diagnostic Tools for IP

To use these tools, will require using a PC and setting up a telnet session towards the system.

Q.931

To show Q.931 trace during a call you need to issue the command 'syslog on'. One can get traces for RAS, Q.931 and H.245 with this command. It is a complex trace and requires an extensive knowledge in H.323 signalling to be understood.

Ping

Ping is used to see if the system is able to reach a specific IP-address, using a mechanism in IP called ICMP. If the system is unable to register to its gatekeeper, or if it is unable to dial a specific endpoint, one can use ping to see if there is at least an IP-route to the gatekeeper or to the endpoint. In case you have problems, one would first ping the default gateway, then the gatekeeper, and then the other endpoint.

Traceroute

Traceroute does exactly that; it traces the route an IP-packet takes to reach its destination and displays all router hops. Traceroute is very useful for seeing exactly where there is a routing-problem in the IP-network, and for checking where transport-delay is introduced.

Layer 4 Ports used in H.323 calls

The layer 4 ports used by the system in a H.323 call can be defined as follows:

- Dynamic: The ports are allocated at random from 2048 to 65535.
- Static: Will use the predefined layer 4 ports listed in the tables below.

Point-to-point + Duo Video

Function	Port	Type
Gatekeeper Discovery (RAS)	1719	UDP
Q.931 Call Setup	1720	TCP
H.245	Range 5555—5556	TCP
Video	Range 2326—2341	UDP
Audio	Range 2326—2341	UDP
Data/FECC	Range 2326—2341	UDP

MultiSite + Duo Video

Function	Port	Type
Gatekeeper Discovery (RAS)	1719	UDP
Q.931 Call Setup	1720	TCP
H.245*	Range 5555—5560	TCP
Video	Range 2326—2406	UDP
Audio	Range 2326—2406	UDP
Data/FECC	Range 2326—2406	UDP

(*) Note: While using MultiSite, if a site is disconnected and reconnected without terminating the entire conference, the next site to be connected will have a H.245 port outside of the specified range. If this functionality is required through a firewall, the range of TCP ports can be extended past 5564. However, if a site is disconnected and reconnected, without ending the conference enough times one can quickly end up outside of this range again.

6.11 Appendix 11

Declaration of Conformity

Contact your TANDBERG representative for a Declaration of Conformity.

Glossary

#

199 AV1: External input for the TANDBERG/LOEWE monitor.

2nd monitor: The second monitor of your videoconferencing system. The second monitor is normally placed on the right side of the first monitor.

4CIF: 4 times CIF, 704x576 pixels

4SIF: 4 times SIF, 704x480 pixels

A

AACLD: Advanced Audio Coding Low Delay

Access code: Use Access code to password protect outgoing calls.

Accessories box: The cabinet contains the following: W.A.V.E. camera, table microphone, remote control and tracker and documentation.

Accessories drawer: See Accessories box

AES: Strong encryption. (Advanced Encryption Standard)

AGC: Automatic Gain Control. Maintains the audio signal level at a fixed value by attenuating strong signals and amplifying weak signals. Very weak signals, i.e. noise alone, will not be amplified.

Alert speaker: The internal speaker will warn you of an incoming call even though the monitor may not be switched on.

Audio call: Audio call equals a telephone call. You can make a call with the video system with audio only.

Audio input 4: Intended for connection to an external microphone amplifier or an external fixed mixer.

Audio input 5: Intended for connection to external playback devices or to telephone add-on hybrids.

Audio out 1: Intended for connection to TANDBERG Natural Audio, televisions or audio amplifiers.

Audio out 2: Intended for connection to audio recording equipment or to a telephone add-on hybrid.

Audio out 3: Intended for connection to a VCR or other recording equipment.

Auto-display snapshot: Sent and received snapshot will automatically appear on fullscreen display.

Auto answer: The system will automatically answer all incoming calls.

Automatic Duo Video: Duo Video Mode is put to Auto. When starting a presentation, Duo Video will start automatically (if possible).

B

Bandwidth: Decides the quality of the video call. High bandwidth gives high quality.

C

- Call control Data Triggered:** Uses TxData, RxData and clock signals only. Use Data Triggered when no handshake signal is available.
- Call control Leased Line:** Is a non-dialing protocol and should be used when two systems are connected in a point-to-point connection. Use Leased Line when the handshaking signals DTR and CD are available.
- Call control Manual:** Should be used when no handshake signals are available, and the external equipment requires a constantly connected line.
- Call control RS366 Dialing:** The only dialing protocol and would normally be used together with network clocking RS449/V35 Compatible when the external system uses RS2366 ports.
- Call status:** Comprehensive information about the call listing transmitted and received audio/video/data information.
- Camera tracking:** Voice Activated Camera Positioning - the camera will automatically view the current speaker.
- Camera tracking mode:** Voice Activated Camera Positioning - the camera will automatically view the current speaker.
- Chair control:** Enables one participant to control the meeting by selecting which of the conference participants that is to be broadcasted to the other participants.
- Channel Hunting:** Normally used in conjunction with PRI daisy-chaining with TANDBERG units in the daisy-chain.
- Channel status:** Comprehensive information about the call progress listing the numbers called, and if an error occurs a cause code is displayed.
- CIF:** Common Intermediate Format, 352x288 pixels
- Closed Captioning:** Text chat.
- Codec:** The Codec is the heart of the system. The main task for the Codec is the compression of outgoing video, audio and data, the transmission of this information to the far end, and the decompression of the incoming information.
- Continous Presence:** See Split Screen
- Control Panel:** The Control Panel is found in the main menu.
- CSU:** Channel Service Unit

D

- Daisy-chaining:** Use of several cameras in a video conference.
- Data mode:** (Dataport) Provides a transparent data channel. The channel can be used for many different purposes, such as file transfer, application sharing and more. This mode requires a TANDBERG system at the far end.
- Dataport:** The system provides two standard RS 232 data ports to allow a computer to be connected for data transfer and control purposes.
- Dataport 1:** Supports 3 different modes: Data mode, Control mode and Modem mode.
- Dataport 2:** Dedicated to the main camera and will not be available in standard configuration.
- DES:** Encryption. (Data Encryption Standard)
- DHCP:** Dynamic Host Configuration Protocol.
- Diagnostics:** Allows testing of individual system components and displays the current system settings.
- Digital ClarityTF:** Participants enjoy presentations of exceptionally high quality resolution video.

- Disconnect site:** As a Chairman, you get the option Disconnect site. Disconnect site allows you to disconnect any participant in the conference.
- Do Not Disturb:** When Do Not Disturb is active the system will not accept any incoming calls. The caller will hear a busy tone when calling the unit.
- Document Camera:** A document camera is an additional camera that is used for showing text, diagrams as well as physical objects.
- DownspeedingTF:** If channels are dropped during a videoconferencing session, the connection is automatically maintained without interruption.
- dual monitor:** The second monitor
- Dual monitor system:** A videoconference system with two monitors.
- Duo VideoTF:** Allows participants at the far end to simultaneously watch a presenter on one screen and a live presentation on the adjoining screen.

E

- E.164 Alias:** The E.164 address of the system. Equivalent to a telephone number, sometimes combined with access codes. The system will not register with the gatekeeper if the E164 alias is not set.
- E1:** Network type, 30 channels. Default for PAL versions.
- Echo canceller:** Continuously adjusts itself to the audio characteristics of the room and compensates for any changes it detects in the audio environment.
- Echo control:** When set to On the far end is prevented to hear their own audio.
- Encryption:** Use encryption to make a secure call. The system will try to make point-to-point calls using encryption. If the far end system supports encryption, the call will be encrypted. If not, the call will proceed without encryption. (Auto encryption). Set encryption to On if you don't want an unencrypted call to be established at all. Set encryption to Off if you don't want to use encryption.
- End view:** Stop viewing the site previously chosen with View Site, and return the view to the site that is currently On Air. Can be used by all conference participants.
- Ethernet Speed:** The speed (Mbps) on the connection from the system to the LAN.

F

- Fallback to telephony:** Enables fallback from video calls to telephony/speech calls.
- Far End:** In a video conference, Far End means the remote side of the conference. Far End Camera is your conferencepartner's camera. Opposite to Near End
- FECC:** Far End Camera Control. When activated it is possible to control the far end's camera, select video sources, activate presets and request still images.
- Floor:** In a multipoint call, use Request Floor to broadcast your picture to all other participants. This is handy when you are having presentations, for teachers etc.

G

- G.711:** Audio algorithm for normal quality audio (telephone quality, 3.1 kHz) The system will always have G.711 enabled.
- G.722:** Audio algorithm for high quality audio (7 kHz).
- G.722.1:** Audio algorithm for compressed high quality audio (7 kHz)
- G.728:** Audio algorithm for compressed normal quality audio (telephone quality, 3.1 kHz)

Gateway: The gateway enables sites on IP and sites on ISDN to participate in meetings with each other.

Global Phone Book: A phone book provided by TMS.

H

H.261: Video algorithm for legacy video compression and decompression. The system will always transmit H.261

H.263: Video algorithm for normal video compression and decompression

H.264: Video algorithm for bandwidth-efficient video compression and decompression

Humfilter: A highpass filter which reduces very low frequency noise.

I

iCIF: Interlaced CIF, 352x288 pixels, 50 fields per second

Incoming call: Someone calls in to your system

Incoming MCU Calls: If occupied in a call, the system will provide a visual/audio indication of an incoming call and ask to accept or reject the call.

IP address: Defines the network address of the system. This address is only used in static mode.

IP assignment: IP-address, IP-subnet mask and Gateway are assigned by the DHCP server.

IP assignment Static: The system's IP-address and IP-subnet mask must be specified in the IP-address field.

IP Precedence: Used to define which priority the system should have in the network. Higher numbers indicate higher priority.

IP subnet mask: Defines the type of network. This address is only used in static mode.

IP TOS: IP Type Of Service. Helps a router select a router path when multiple paths are available.

iSIF: Interlaced SIF, 352x240 pixels, 60 fields per second

L

Layout: Use the Layout key to change picture layout on the screen.

M

Main Camera: Your camera. Video input 1

Max call length: This feature will automatically end both incoming and outgoing calls when the call time exceeds the length specified.

Max channels: Indicates the maximum number of channels the system is allowed to use on the E1/T1 interface.

MCU: Multipoint Conference Unit.

MCU status line: Shows indicators for MultiSite, MCU and DuoVideo

MicOff: Microphone is switched off.

Mix mode: How to adjust the weighting of each microphone to obtain the best possible audio and minimize the background noise.

Modem mode: (Dataport) Supports external control of the system via a PC as in Control Mode. Once a call is established, Dataport 1 will automatically switch to Data mode. When the call disconnects, Dataport 1 switches back to Control Mode.

MSN: Multiple Subscriber Number. Possible to attach different ISDN terminals, with different numbers, to the same physical ISDN telephone line. The service can be ordered from the telephone company.

multipoint call: A call with more than two participants including yourself

MultiSite: The TANDBERG systems internal MCU. Built-in system which makes it possible to establish meetings with up to 5 video calls and 5 telephone calls.

MultiSite cascading: By connecting up to 4 MultiSite systems together to achieve a higher number of participants in a multipoint call.

N

NAT: Network Address Translation. NAT support in the videoconferencing system enables proper exchange of audio/video data when connected to an external videoconferencing system when the IP traffic goes through a NAT router. Used in small LANs, often home offices, when a PC and a videoconferencing system is connected to a router with NAT support.

NAT Address: The external/global IP-address to the router with NAT support. Packets sent to the router will then be routed to the system's IP address.

Natural Audio Module™: Designed to improve audio quality during a videoconference. It is mounted in the cabinet above the Codec and consists of an audio system optimized for speech.

Natural Presenter Package: Consists of Duo Video, Digital Clarity and PC Presenter.

Natural VideoTF: 60 fields per second true interlaced picture.

Near End: In a video conference, Near End means your own side of the conference. Near Camera is your own camera. Opposite to Far End

Network clocking: Specifies the number of physical external clock signals.

Network Interface: Indicates if the network is of type E1 or T1.

Network profiles: It is possible to define up to 6 network profiles, each consisting of name and call prefix, and 3 of them also include network selection.

Non Standard Facility: The network provider may require service selection in your ISDN configuration. Valid NSF codes are from 1 to 31. 0 will disable NSF service codes.

NR: Noise Reduction. Reduces constant background noise (e.g. noise from air-conditioning systems, cooling fans, etc.).

NSF: Non Standard Facility.

NTSC: National Television System Committee. Video standard corresponding to 4SIF. Primary used in USA, Japan and other countries.

O

Option Key: Required by the system to activate optional features such as MultiSite and Presenter.

P

PAL: Phase Alternation by Line. Video standard corresponding to 4CIF. Primary used in Europe, Middle East and Asia

Parallel dial: Channels will be dialed and connected in parallel when setting up a bonding call.

PC PresenterTF: An easily accessible PC connection plug. When connected the PC image is displayed on the monitor.

PC SoftPresenterTF: Shows PC images via the LAN connection.

PIP: Picture-In-Picture

point-to-point call: A call with two participants including your self

POP: Picture Outside Picture. POP is a picture layout mode that is optimized for wide screens: Fullscreen, 1+3 layout and emulated dual monitor layout.

Presentation: Presentation means to show another video source. Use the Presentation Key for a predefined presentation source. Use the presentation menu to choose among all available video sources.

Presentation source: The videosource that is on display when you press the Presentation Key on the remote control

Presets: Predefined camera positions (and video sources)

Q

QCIF: Quarter CIF, 176x144 pixels

QSIF: Quarter SIF, 176x120 pixels

R

Release Floor: To end the request floor function.

release floor to site: Allows the chairman to release the floor.

Remote: Short for Remote Control

Request Floor: The MCU will broadcast the video in full screen to all other participants in the conference. If the MCU conference has a chairman, a request will be sent to the chairman.

Restart: Restarts the system.

Restore defaults: Restores system settings to the factory defaults.

Restricted call: A call to a 56 kbps network. By default the system will dial an unrestricted call (a call to a 64 kbps network) and downspeed to 56 kbps if necessary.

S

S-VHS: S-video

S-video: The standard camera uses one of the S-video inputs in the codec.

Selfview: Outgoing video. In most cases, the image of your self.

Side-by-Side: Side-by-side view means that two pictures are displayed side by side each other on the screen. You will see two equally sized pictures.

SIF: Standard Input Format, 352x240 pixels

SNMP: Simple Network Management Protocol.

SNMP Community: SNMP Community names are used to authenticate SNMP requests. SNMP requests must have a password in order to receive a response from the SNMP agent in the system. The SNMP Community name is case sensitive.

SNMP Trap Host: Identifies the IP-address of the SNMP manager.

- SNMP traps:** Generated by the agent to inform the manager about important events.
- SoftMux:** Ensures high reliability and includes the unique Downspeeding feature. It also makes it possible to dial to another videoconferencing equipment, phones and mobile phones in a uniform way, and provides an on-screen, real-time feedback on the progress of a call.
- Split Screen:** All the participants in a MultiSite conference are displayed on the screen. (Former Continuous Presence)
- Start Channel:** Indicates the first E1/T1 channel the system is allowed to use. The setting might be used when if the E1/T1 line is shared with other equipment.
- Start up video source:** The video source that is on display when the system wakes up from standby mode.
- Status Format:** Provides call quality feedback on the status line.
- Streaming:** Allows broadcasting of audio/video via an IP network.
- Streaming Address:** Defined as the IP-address of a streaming client, streaming server or a multicast address.
- Streaming Address Port:** If several codecs are streaming to the same IP-address, different ports have to be used in order for the client to know which stream to receive.
- Streaming Allow remote Start:** Streaming can be started from the Videoconferencing system using the remote control, by using the Dataport, or from external user interfaces like the Web-browser or Telnet session.
- Streaming Announcements:** The system will announce to the network that it is streaming. This enables a streaming client (e.g. a PC) to connect to the system's streaming session. Used by Cisco IP/TV.
- Streaming Password:** Prevents unauthorized access to the streaming functionality.
- Streaming Source:** Select between local video and/or far end video to be streamed. Local and far end audio is always streamed.
- Streaming TTL/Router Hops:** Used for streaming data to limit how many routers the data should pass before it is rejected.
- Streaming Video Rate:** Defines the Video streaming rate from the system.
- SVGA:** Super VGA. (800x600)
- SXGA:** Super eXtended Graphics Array (1280x1024)
- System information:** Lists system numbers, line status, software version and other useful information.
- System name:** Identifies a videoconferencing system

T

- T1:** Network type, 24 channels. Default for NTSC versions.
- T1 Line Coding:** Indicates how the signals on the line should be coded. If parts of the systems use restricted coding, this should be selected.
- Take chair:** Request chairmanship of the conference. If no one else is chairman, the request is granted.
- TCS-4:** Used to address different systems on a LAN when dialing in via a gateway.
- Terminal Names:** Lists the site numbers or name (if supported) of other sites connected in the conference.
- Terminate meeting:** The chairman can terminate the conference, i.e. all participants are disconnected.

TMS: TANDBERG Management Suite

Touch Tones: To dial extension numbers ect. during a call, use touch tones in order to get tones instead of preset on the number keys.

Tracker: The tracker is a small infrared remote control device made to steer the camera to any desired location within the room.

TSC-1: TCS-1 is used for H243 password on H320 MCU's

V

VCR: Video Cassette Recorder

VGA: Video Graphics Array. (640 x 480)

VGA Out Quality: Changes the resolution of the VGA signal available in the VGA Out connector at the rear of the codec.

View administrator settings: Displays all the system settings in a read only format.

View site: View any participant in the conference other than the participant currently On Air. Can be used by all conference participants.

VNC: Virtual Network Computing.

Voice Switched: The active site will be displayed in full screen during a MultiSite conference.

W

WAVE Camera: Wide Angle View Camera - delivers the widest angle of view in the industry.

Welcome menu: The welcome menu displays the main menu when you are outside a call.

X

XGA: eXtended Graphics Array (1024 x 768)

Index

A		
Access Code.....	62	
Add Another Call.....	26	
Administrator Password.....	70	
Alert Tones and Volume	84	
Allowance	62	
Answer an incoming Call	29	
Assign Floor to Participant.....	49	
Audi Algorithm	76	
Audio		
Inputs	80	
Outputs.....	81	
Auto answer.....	61	
Automatic Camera Tracking.....	56	
C		
Call Settings.....	27	
Call Status	99	
Camera Tracking Mode	85	
Codec	6	
D		
Default Call Settings	78	
Display	56	
Do Not Disturb	32	
Document camera	107	
Dual Monitor	61, 113	
Duo Video	44	
E		
Echo Control.....	82	
Encryption.....	89	
End Call	30	
Extra cameras.....	110	
F		
Far End Camera Control	38	
Far End Control	55	
G		
G.728	78	
Group Layout	48	
H		
H.323 Settings	94	
I		
Indicators	23	
Interfaces	106	
IP Address Conflict Check.....	105	
IP Settings	93	
L		
Language.....	60	
Layout	19	
Letter keys	21	
Logo.....	69	
M		
Max Call Length.....	61	
MCU.....	50	
MCU Status Line.....	85	
Menu timeout in call.....	68	
Microphone.....	6	
MultiSite	50	
MultiSite (Built-in).....	50	
N		
Natural Video	78	
Network Profiles.....	97	
Number keys.....	21	
P		
PC Presenter	43	
PC Soft Presenter.....	44	
PC SoftPresenter	44	
Phone Book		
Delete	37	
Edit	36	
Global	34	
MultiSite.....	35	
Picture Control	88	
Postpone 1 hour.....	32	
Postpone 3 hours.....	32	
Presentation		
Presentation Key.....	41	
Presentation Menu	41	
Presets	39	
R		
Release Chair	50	
Release Floor.....	48	
Release Floor from Participant	49	
Remote control		
batteries.....	6	
Request Floor	48	
Restart	58	
Restore defaults.....	105	
S		
Screen Settings.....	63	
Selfview.....	19	
Snapshot.....	45	
Software Options	66	
Stereo I/O mode.....	83	
System configuration	13	
System Name	60	
T		
Take Chair	50	
Telephone Add-On.....	109	
Telephone Call.....	26	
Terminate Meeting.....	50	
Text Chat	57	
U		
User Guide.....	53	
V		
Video Algorithm.....	76	
Video Call.....	25	
Video cassette recorder (VCR).....	108	
Video Name	88	
Video Quality.....	78	
View Administrator Settings.....	101	
View Site	50	

Volume + and -	21	Welcome Picture	69
W		Welcome Screen.....	16
WAVE-camera	6	Welcome text	70
Web Snapshots	86	Z	
Welcome menu.....	16, 68	Zoom	38