

SONY®

4-132-058-11(1)

Digital Still Camera Instruction Manual

DSC-HX1

Before operating the unit, please read this manual thoroughly, and retain it for future reference.



Getting started

Shooting/viewing
images

Using shooting
functions

Using viewing
functions

Deleting images

Connecting to other
devices

Changing camera
settings

© 2009 Sony Corporation

GB

Cyber-shot

Owner's Record

The model and serial numbers are located on the bottom. Record the serial number in the space provided below. Refer to these numbers whenever you call upon your Sony dealer regarding this product.

Model No. DSC-HX1

Serial No. _____

WARNING

To reduce fire or shock hazard, do not expose the unit to rain or moisture.

IMPORTANT SAFETY INSTRUCTIONS

**-SAVE THESE
INSTRUCTIONS**

DANGER

**TO REDUCE THE RISK OF
FIRE OR ELECTRIC
SHOCK, CAREFULLY
FOLLOW THESE
INSTRUCTIONS**

If the shape of the plug does not fit the power outlet, use an attachment plug adaptor of the proper configuration for the power outlet.

CAUTION

Battery pack

If the battery pack is mishandled, the battery pack can burst, cause a fire or even chemical burns. Observe the following cautions.

- Do not disassemble.
- Do not crush and do not expose the battery pack to any shock or force such as hammering, dropping or stepping on it.
- Do not short circuit and do not allow metal objects to come into contact with the battery terminals.
- Do not expose to high temperature above 60 °C (140 °F) such as in direct sunlight or in a car parked in the sun.
- Do not incinerate or dispose of in fire.
- Do not handle damaged or leaking lithium ion batteries.
- Be sure to charge the battery pack using a genuine Sony battery charger or a device that can charge the battery pack.
- Keep the battery pack out of the reach of small children.
- Keep the battery pack dry.

- Replace only with the same or equivalent type recommended by Sony.
- Dispose of used battery packs promptly as described in the instructions.

Battery charger

Even if the CHARGE lamp is not lit, the battery charger is not disconnected from the AC power source (mains) as long as it is connected to the wall outlet (wall socket). If some trouble occurs while using the battery charger, immediately shut off the power by disconnecting the plug from the wall outlet (wall socket).

For Customers in the U.S.A. and Canada

RECYCLING LITHIUM-ION BATTERIES

Lithium-Ion batteries are recyclable.

You can help preserve our environment by returning your used rechargeable batteries to the collection and recycling location nearest you.



For more information regarding recycling of rechargeable batteries, call toll free 1-800-822-8837, or visit <http://www.rbric.org/>

Caution: Do not handle damaged or leaking Lithium-Ion batteries.

Battery pack

This device complies with Part 15 of the FCC Rules. Operation is subject to the following two conditions: (1) This device may not cause harmful interference, and (2) this device must accept any interference received, including interference that may cause undesired operation.

This Class B digital apparatus complies with Canadian ICES-003.

For Customers in the U.S.A.

UL is an internationally recognized safety organization.

This product has received UL Listing.

If you have any questions about this product, you may call:

Sony Customer Information Center
1-800-222-SONY (7669)

The number below is for the FCC related matters only.

Regulatory Information

Declaration of Conformity

Trade Name: SONY

Model No.: DSC-HX1

Responsible Party: Sony Electronics Inc.

Address: 16530 Via Esprillo,
San Diego, CA 92127U.S.A.

Telephone No.: 858-942-2230

This device complies with Part 15 of the FCC Rules. Operation is subject to the following two conditions: (1) This device may not cause harmful interference, and (2) this device must accept any interference received, including interference that may cause undesired operation.

CAUTION

You are cautioned that any changes or modifications not expressly approved in this manual could void your authority to operate this equipment.

Note:

This equipment has been tested and found to comply with the limits for a Class B digital device, pursuant to Part 15 of the FCC Rules. These limits are designed to provide reasonable protection against harmful interference in a residential installation. This equipment generates, uses, and can radiate radio frequency energy and, if not installed and used in accordance with the instructions, may cause harmful interference to radio communications. However, there is no guarantee that interference will not occur in a particular installation. If this equipment does cause harmful interference to radio or television reception, which can be determined by turning the equipment off and on, the user is encouraged to try to correct the interference by one or more of the following measures:

- Reorient or relocate the receiving antenna.
- Increase the separation between the equipment and receiver.
- Connect the equipment into an outlet on a circuit different from that to which the receiver is connected.
- Consult the dealer or an experienced radio/TV technician for help.

The supplied interface cable must be used with the equipment in order to comply with the limits for a digital device pursuant to Subpart B of Part 15 of FCC Rules.

For Customers in Europe

Notice for the customers in the countries applying EU Directives

The manufacturer of this product is Sony Corporation, 1-7-1 Konan Minato-ku Tokyo, 108-0075 Japan. The Authorized Representative for EMC and product safety is Sony Deutschland GmbH, Hedelfinger Strasse 61, 70327 Stuttgart, Germany. For any service or guarantee matters please refer to the addresses given in separate service or guarantee documents.

This product has been tested and found compliant with the limits set out in the EMC Directive for using connection cables shorter than 3 meters (9.8 feet).

Attention

The electromagnetic fields at the specific frequencies may influence the picture and sound of this unit.

Notice

If static electricity or electromagnetism causes data transfer to discontinue midway (fail), restart the application or disconnect and connect the communication cable (USB, etc.) again.

Disposal of Old Electrical & Electronic Equipment (Applicable in the European Union and other European countries with separate collection systems)



This symbol on the product or on its packaging indicates that this product shall not be treated as household waste. Instead it shall be handed over to the applicable collection point for the recycling of electrical and electronic equipment. By ensuring this product is disposed of correctly, you will help prevent potential negative consequences for the environment and human health, which could otherwise be caused by inappropriate waste handling of this product. The recycling of materials will help to conserve natural resources. For more detailed information about recycling of this product, please contact your local Civic Office, your household waste disposal service or the shop where you purchased the product.

Disposal of waste batteries (applicable in the European Union and other European countries with separate collection systems)



This symbol on the battery or on the packaging indicates that the battery provided with this product shall not be treated as household waste. By ensuring these batteries are disposed of correctly, you will help prevent potentially negative consequences for the environment and human health which could otherwise be caused by inappropriate waste handling of the battery. The recycling of the materials will help to conserve natural resources.

In case of products that for safety, performance or data integrity reasons require a permanent connection with an incorporated battery, this battery should be replaced by qualified service staff only. To ensure that the battery will be treated properly, hand over the product at end-of-life to the applicable collection point for the recycling of electrical and electronic equipment.

For all other batteries, please view the section on how to remove the battery from the product safely.

Hand the battery over to the applicable collection point for the recycling of waste batteries.

For more detailed information about recycling of this product or battery, please contact your local Civic Office, your household waste disposal service or the shop where you purchased the product.

Notice for customers in the United Kingdom

A moulded plug complying with BS 1363 is fitted to this equipment for your safety and convenience.

Should the fuse in the plug supplied need to be replaced, a fuse of the same rating as the supplied one and approved by ASTA or BSI to BS 1362, (i.e., marked with an ⚡ or ⚡ mark) must be used.

If the plug supplied with this equipment has a detachable fuse cover, be sure to attach the fuse cover after you change the fuse. Never use the plug without the fuse cover. If you should lose the fuse cover, please contact your nearest Sony service station.

Table of contents

Notes on using the camera	8
---------------------------------	---

Getting started 10

Checking the accessories supplied	10
Identifying parts	11
Charging the battery pack	13
Inserting the battery pack/a “Memory Stick Duo” media (sold separately)	15
Setting the clock	18

Shooting/viewing images 20

Shooting images	20
Viewing images	21

Using shooting functions 22

Displaying minimum indicators (Easy Shooting)	22
Detecting smiles and shooting automatically (Smile Shutter)	23
Detecting the shooting conditions automatically (Scene Recognition) ...	24
Selecting the focus method	26
Focusing on the face of the subject (Face Detection)	27
Shooting close-ups (Macro)	28
Using the self-timer	28
Selecting a flash mode	29
Changing the screen display	30
Selecting the image size to match the usage	31
Shooting with Program Auto	33
Shooting moving subjects with different effects (Shutter Speed Priority Shooting)	34
Adjusting background blur, and shooting (Aperture Priority Shooting)	35
Shooting with a desired exposure (Manual Exposure Shooting)	36
Shooting with reduced blur	37
Shooting panoramic images	38
Shooting continuously (High-speed burst shooting/Exposure bracket)	40
Using the Shooting mode that matches the scene (Scene Selection)	42
Shooting movies	44

Using viewing functions	46
Viewing an enlarged image (Playback zoom).....	46
Searching for an image (Image Index)	46
Selecting the display format (View Mode).....	47
<hr/>	
Deleting images	48
Deleting images	48
<hr/>	
Connecting to other devices	49
Viewing images on a TV	49
Printing still images	50
Using the camera with a computer	52
<hr/>	
Changing camera settings	56
Changing the operation sounds	56
Setting the custom button	57
Using the MENU items	58
Using the  (Settings) items	62
<hr/>	
Others	65
Learning more about the camera ("Cyber-shot Handbook")	65
List of icons displayed on the screen.....	66
Troubleshooting.....	69
Precautions.....	72
Specifications	73

Notes on using the camera

Internal memory and “Memory Stick Duo” media back up

Do not turn off the camera, remove the battery pack, or remove the “Memory Stick Duo” media while the access lamp is lit. Otherwise, the internal memory data or “Memory Stick Duo” media may be damaged. Be sure to make a backup copy to protect your data.

On management files

When you insert a “Memory Stick Duo” media without a management file into the camera and turn on the power, part of the “Memory Stick Duo” media capacity is used to automatically create a management file. It may take some time until you can perform the next operation.

Notes on recording/playback

- Before you start recording, make a trial recording to make sure that the camera is working correctly.
- The camera is neither dust-proof, nor splash-proof, nor water-proof. Read “Precautions” (page 72) before operating the camera.
- Avoid exposing the camera to water. If water enters inside the camera, a malfunction may occur. In some cases, the camera cannot be repaired.
- Do not aim the camera at the sun or other bright light. It may cause the malfunction of the camera.
- Do not use the camera near a location that generates strong radio waves or emits radiation. Otherwise, the camera may not properly record or play back images.
- Using the camera in sandy or dusty locations may cause malfunctions.
- If moisture condensation occurs, remove it before using the camera (page 72).
- Do not shake or strike the camera. It may cause a malfunction and you may not be able to record images. Furthermore, the recording media may become unusable or image data may be damaged.
- Clean the flash surface before use. The heat of flash emission may cause dirt on the flash surface to become discolored or to stick to the flash surface, resulting in insufficient light emission.

Notes on the LCD screen, the LCD finder and lens

- The LCD screen is manufactured using extremely high-precision technology so over 99.99% of the pixels are operational for effective use. However, some tiny black and/or bright dots (white, red, blue or green) may appear on the LCD screen. These dots are a normal result of the manufacturing process, and do not affect the recording.
- When the battery level becomes low, the lens might stop moving. Insert a charged battery pack and turn on the camera again.
- Do not hold the camera by taking hold of the LCD screen.



On camera's temperature

Your camera and battery may get warm due to continuous use, but it is not a malfunction.

On the overheat protection

Depending on the camera and battery temperature, you may be unable to record movies or the power may turn off automatically to protect the camera. A message will be displayed on the LCD screen before the power turns off or you can no longer record movies.

On image data compatibility

- The camera conforms with DCF (Design rule for Camera File system) universal standard established by JEITA (Japan Electronics and Information Technology Industries Association).
- Sony does not guarantee that the camera will play back images recorded or edited with other equipment, or that other equipment will play back images recorded with the camera.

If you cannot record/play back images, perform [Initialize]

If you repeat recording/deleting images for a long time, fragmentation of data occurs on the media. Images cannot be saved or recorded. In such a case, save your images on some type of external media first, and then perform [Initialize] in **☑** (Main Settings) (page 63).

Note when playing movies on other devices

This camera utilizes MPEG-4 AVC/H.264 Main Profile to record movies. Therefore, movies recorded using this camera cannot be played on devices that do not support MPEG-4 AVC/H.264.

Warning on copyright

Television programs, films, videotapes, and other materials may be copyrighted. Unauthorized recording of such materials may be contrary to the provisions of the copyright laws.

No compensation for damaged content or recording failure

Sony cannot compensate for failure to record or loss or damage of recorded content due to a malfunction of the camera or recording media, etc.

Checking the accessories supplied

- Battery charger BC-VH1 (1)

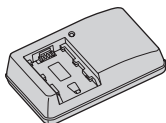

- Power cord (mains lead) (1)
(not supplied in the USA and Canada)



- Rechargeable battery pack NP-FH50 (1)

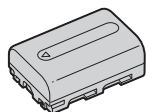

- USB, A/V cable for multi-use terminal (1)

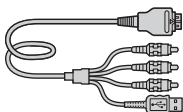

- HDMI adaptor (1)



- Shoulder strap (1)

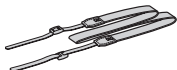

- Lens cap (1)/Lens cap strap (1)

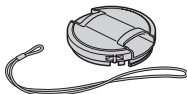

- CD-ROM (1)
 - Cyber-shot application software
 - “Cyber-shot Handbook”
 - “Cyber-shot Step-up Guide”
- Instruction Manual (this manual) (1)

Using the shoulder strap

Attach the shoulder strap and lens cap strap to prevent the camera from being dropped and damaged.

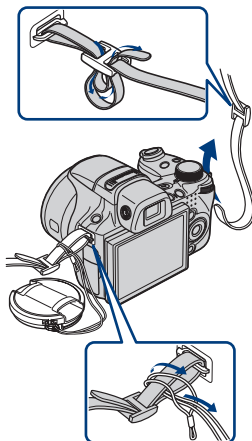

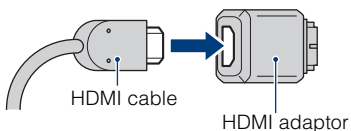

About HDMI adaptor

When you connect the camera to the TV with an HDMI cable, attach the HDMI adaptor (supplied) to the HDMI cable (sold separately) and connect it to the multi connector of the camera.

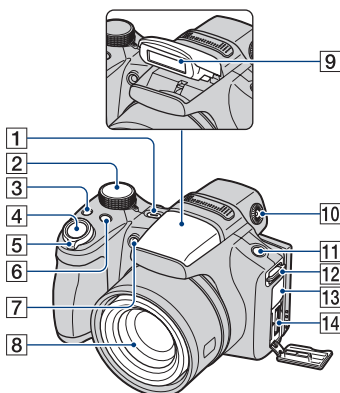

Identifying parts



- 1** ON/OFF (Power) button
- 2** Mode dial
- 3** /BRK (Burst/Bracket) button
- 4** Shutter button
- 5** For shooting: W/T (Zoom) lever
For viewing:  (Index) lever/Q (Playback zoom) lever
- 6** FOCUS button
- 7** Self-timer lamp/Smile Shutter lamp/
AF illuminator
- 8** Lens
- 9** Flash
- 10** Finder adjustment dial
 - You can choose to shoot using the finder with the FINDER/LCD button. Adjust the finder adjustment dial to your eyesight so that the image appears clearly within the finder.
 - Face the camera toward the brighter area for easier adjustment.
- 11** FINDER/LCD button
 - Switch the finder or LCD screen to view for shooting.
- 12** Hook for shoulder strap

- 13** DC IN jack/DC IN jack cover
 - You cannot charge the battery pack by connecting your camera to the AC Adaptor (sold separately). Use the battery charger to charge the battery pack.
- 14** Multi connector

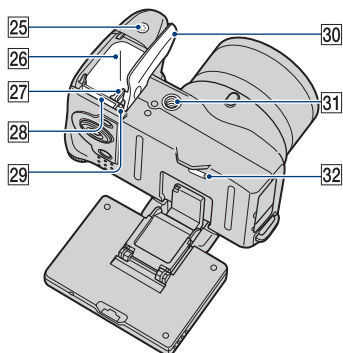
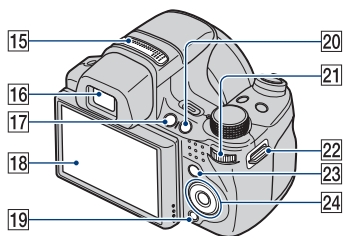

15 Stereo microphone

16 Finder

17  (Playback) button

18 LCD screen

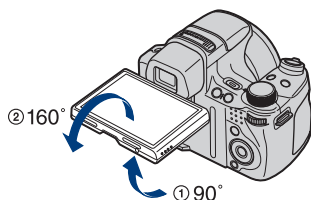

- You can adjust the angle of the LCD screen 90 degrees towards ① or 160 degrees towards ②. Forcing the LCD screen to move over the range of movement may cause malfunction.

19  (Delete) button

20  (Custom) button

21 Jog dial

Press



Turn



22 Hook for shoulder strap

23 MENU button

24 Control button

Menu on: 
Menu off: DISP/ 

25 Speaker

26 Battery insert slot

27 Battery eject lever

28 “Memory Stick Duo” media slot

29 Access lamp

30 Battery/“Memory Stick Duo” media cover

31 Tripod receptacle

- Use a tripod with a screw less than 5.5 mm (7/32 inches) long. Otherwise, you cannot firmly secure the camera, and damage to the camera may occur.

32 RESET button

Charging the battery pack

1 Insert the battery pack into the battery charger.

- You can charge the battery even when it is partially charged.



Battery pack

2 Connect the battery charger to the wall outlet (wall socket).

If you continue charging the battery pack for about one more hour after the CHARGE lamp turns off, the charge will last slightly longer (Full charge).

CHARGE lamp

Lit: Charging

Off: Charging finished (Normal charge)

For customers in the USA and Canada

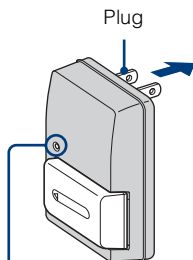

CHARGE lamp

For customers in countries/regions other than the USA and Canada

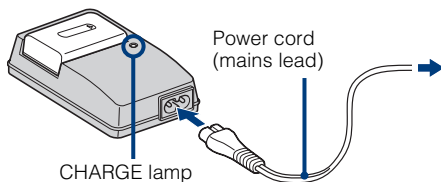

CHARGE lamp

3 When charging is finished, disconnect the battery charger.

Charging time

Full charge time	Normal charge time
Approx. 256 min.	Approx. 205 min.

Notes

- The table above shows the time required to charge a fully depleted battery pack at a temperature of 25 °C (77 °F). Charging may take longer depending on conditions of use and circumstances.
- Connect the battery charger to the nearest wall outlet (wall socket).
- When charging is finished, disconnect the power cord (mains lead) from the wall outlet (wall socket), and remove the battery pack from the battery charger.
- Be sure to use the battery pack or the battery charger of the genuine Sony brand.

Battery life and number of images you can record/view

		Battery life (min.)	No. of Images
Shooting still images	LCD screen	Approx. 195	Approx. 390
	Finder	Approx. 200	Approx. 400
Viewing still images		Approx. 370	Approx. 7400

The measurement method is based on the CIPA standard. (CIPA: Camera & Imaging Products Association)

Note

- The battery life and the number of still images may vary depending on the camera settings.



Using the camera abroad

You can use the camera, the battery charger (supplied), and the AC Adaptor (sold separately) in any country or region where the power supply is within 100 V to 240 V AC, 50 Hz/60 Hz.

Do not use an electronic transformer (travel converter). This may cause a malfunction.

Inserting the battery pack/a “Memory Stick Duo” media (sold separately)

1 Open the cover.

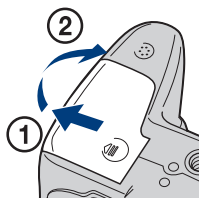

2 Insert the “Memory Stick Duo” media (sold separately).

With the terminal side facing the lens, insert the “Memory Stick Duo” media until it clicks into place.

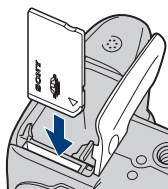

3 Insert the battery pack.

Insert the battery with the ▲ mark downward while pressing the battery eject lever in the direction of the arrow.

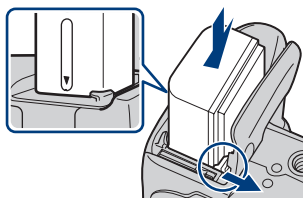

4 Close the cover.

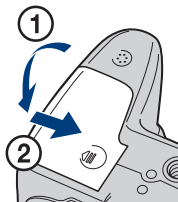

“Memory Stick” media that you can use

“Memory Stick Duo” media



You can also use a “Memory Stick PRO Duo” media or “Memory Stick PRO-HG Duo” media with the camera.

For recording movies with [1440×1080(Fine)], it is recommended that you use a “Memory Stick PRO Duo” media of 512 MB or larger marked with:

- MEMORY STICK PRO DUO (“Memory Stick PRO Duo” media)*
- MEMORY STICK PRO-HG DUO (“Memory Stick PRO-HG Duo” media)

* You can use “Memory Stick PRO Duo” media whether Mark2 is indicated or not.

For details on the number of images/time that can be recorded, see pages 32, 45. Other types of “Memory Stick” media or memory card are not compatible with the camera.

“Memory Stick” media

You cannot use a “Memory Stick” media with the camera.



To remove the “Memory Stick Duo” media

Access lamp

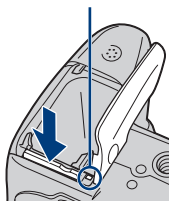



Make sure that the access lamp is not lit, then push the “Memory Stick Duo” media in once.

Note

- Never remove the “Memory Stick Duo” media/battery pack when the access lamp is lit. This may cause damage to data in the “Memory Stick Duo” media/internal memory.

When there is no “Memory Stick Duo” media inserted

Images are stored in the camera’s internal memory (approximately 11 MB).

To copy images from the internal memory to a “Memory Stick Duo” media, insert the “Memory Stick Duo” media in the camera, then select MENU →  (Settings) →  (“Memory Stick” Tool) → [Copy].

To remove the battery pack

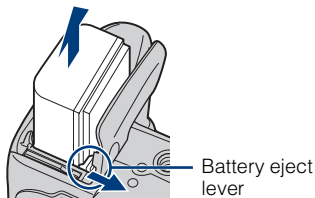

Slide the battery eject lever. Be sure not to drop the battery pack.



■ Checking the remaining battery charge

A remaining charge indicator appears on the upper left of the LCD screen.

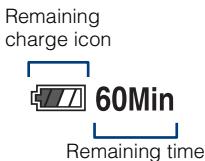

Notes

- It takes about one minute until the correct remaining charge indicator appears.
- The remaining charge indicator may not be correct under certain circumstances.
- Battery capacity decreases over time and through repeated use. When the operating time per charge decreases markedly, the battery pack needs to be replaced. Purchase a new battery pack.
- If the camera is running on and you do not operate the camera for about three minutes, the camera turns off automatically (Auto power-off function).

Setting the clock

1 Press the ON/OFF (Power) button.

The camera is turned on.

- It may take time for the power to turn on and allow operation.

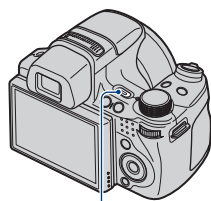

ON/OFF (Power) button

2 Select a setting item with ▲/▼ on the control button, then press ●.

Date & Time Format: Select the date and time display format.

Daylight Savings: Select Daylight Savings On/Off.

Date & Time: Sets the date and time.

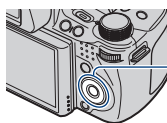

Control button

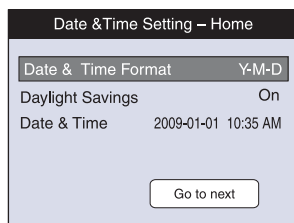

3 Set the numeric value and desired settings with ▲/▼/◀/▶, then press ●.

- Midnight is indicated as 12:00 AM, and noon as 12:00 PM.

4 Select [Go to next], then press ●.

5 Select your desired area with ◀/▶ on the control button, then press ●.

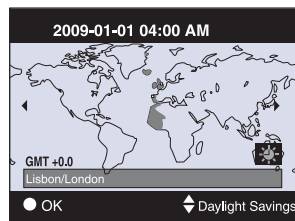

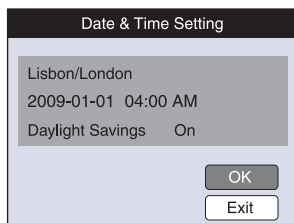

6 Select [OK], then press ●.



Note

- The camera does not have a feature for superimposing dates on images. By using “PMB” in the CD-ROM (supplied), you can print or save images with the date.

Setting the date and time again

Press the MENU button, then select  (Settings) →  (Clock Settings) (page 64).

Shooting images

- 1 Set the mode dial to  (Intelligent Auto Adjustment), then press ON/OFF (Power) button.

To shoot movies, set the mode dial to  (Movie Mode) (page 44).

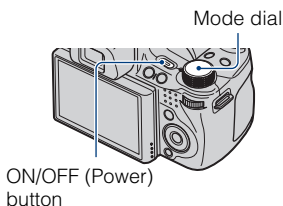

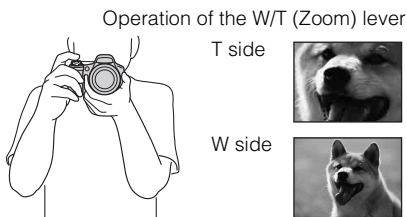

- 2 Hold the camera steady as illustrated.

- Turn the W/T (Zoom) lever to the T side to zoom in, and turn it to the W side to return.
- Turn the W/T (Zoom) lever slightly to zoom slowly, and more to zoom quickly.



- 3 Press the shutter button halfway down to focus.

 is displayed to indicate that SteadyShot is working. When the image is in focus, a beep sounds and the  indicator lights.

- The shortest shooting distance is approximately 1 cm (13/32 inches) (W)/150 cm (4 feet 11 1/8 inches) (T) (from the lens).

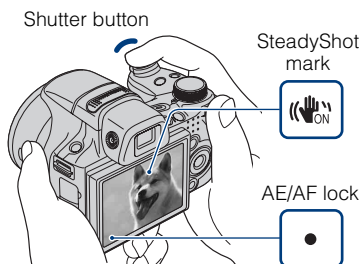

- 4 Press the shutter button fully down.

The image is shot.

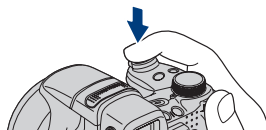

Viewing images

1 Press the (Playback) button.

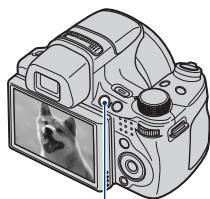

The last image shot is displayed.

- When images on the “Memory Stick Duo” media recorded with other cameras cannot be played back on this camera, view the images in [Folder View] (page 47).





 (Playback) button

■ Selecting next/previous image

Select an image with  (next)/ (previous) on the control button. You can also select an image with the jog dial.

■ Deleting an image

- ① Press  (Delete) button.
- ② Select [This Image] with  on the control button, then press .

■ Returning to shooting images

Press the shutter button halfway down.

■ Turning off the camera

Press ON/OFF (Power) button.

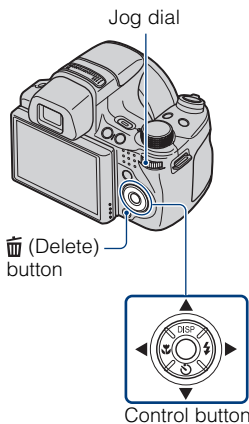



Displaying minimum indicators (Easy Shooting)

This mode uses the minimum number of settings. The text size increases and indicators become easier to see.

- 1 Set the mode dial to **EASY** (Easy Shooting).



Action	How to change
Self-Timer	Press  on the control button → Select [Self-Timer 10sec] or [Self-Timer Off].
Image Size	Press MENU → Select [Large] or [Small] from [Image Size].
Flash	Press  on the control button → Select [Flash Auto] or [Flash Off]/ Press MENU → [Flash] → Select [Auto] or [Off].



On Easy Viewing mode

When you press the  (Playback) button with the mode dial set to **EASY** (Easy Shooting), the playback screen text becomes larger and easier to see. In addition, the functions that can be used are limited.

 (Delete) button: You can delete the currently displayed image.

Select [OK] → .

MENU button: You can delete the currently displayed image with [Delete Single Image], delete all images in a folder with [Delete All Images].

Detecting smiles and shooting automatically (Smile Shutter)

1 Press the C (Custom) button.

- If the Smile Shutter screen does not appear, set [Smile Shutter] with [Custom Button] in  (Settings).

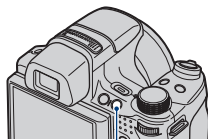

C (Custom) button

2 Wait detecting a smile.

- When the smile level exceeds the ◀ point on the indicator, the camera shoots images automatically. When you press the C (Custom) button again, Smile Shutter ends.
- If you press the shutter button during Smile Shutter, the camera shoots the image, then returns to Smile Shutter mode.

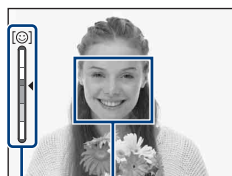

Face Detection frame

Smile Detection Sensitivity indicator



Hints for better capturing of smiles

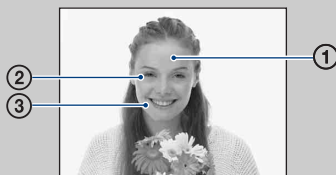









- ① Do not cover the eyes with the bangs.
- ② Try to orient the face in front of the camera and be as level as possible. The detection rate is higher when the eyes are narrowed.
- ③ Give a clear smile with an open mouth. The smile is easier to detect when the teeth are showing.

Detecting the shooting conditions automatically (Scene Recognition)

- 1 Set the mode dial to  (Intelligent Auto Adjustment).



- 2 Aim the camera at the subject.

When the camera recognizes a scene, a Scene Recognition icon, , , , , , ,  or  is displayed on the LCD screen.



Scene Recognition icon

- 3 Press the shutter button halfway down to focus on the subject, then shoot images.



Shooting two images with different settings and selecting the one you like

Press the MENU button, then select (Scene Recognition) → (Advanced) with ▲/▼/◀/▶ on the control button.

When the camera recognizes a difficult-to-shoot scene ((Twilight), (Twilight Portrait), (Twilight using a tripod), (Backlight), (Backlight Portrait)), it changes the settings as follows and shoots two images with different effects.

	First shot	Second shot
	Shot in Slow Synchro mode	Shot with the sensitivity increased to reduce blur
	Shot in Slow Synchro mode using the face most illuminated by the flash as the reference	Shot with the sensitivity increased using the face most illuminated by the flash as the reference to reduce blur
	Shot in Slow Synchro mode	Shot with a slower shutter speed and the sensitivity not increased
	Shot using the flash	Shot with the background brightness and contrast adjusted (DRO plus)
	Shot using the face most illuminated by the flash as the reference	Shot with the face and background brightness and contrast adjusted (DRO plus)

When shooting with Scene Recognition set to [Advanced], the camera automatically takes two shots when (Portrait) is recognized. An image without closed eyes is automatically selected, displayed, and recorded.

Selecting the focus method

1 Press the FOCUS button.

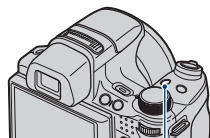

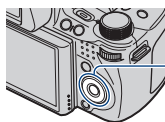

FOCUS button

2 Select the desired mode with ▲/▼/◀/▶ on the control button → ●.



 **(Multi AF):** Focuses on a subject in all range of the finder frame automatically.

 **(Center AF):** Focuses on a subject in the center of the finder frame automatically.

 **(Flexible Spot AF):** Move the AF range finder frame to the desired spot and focuses on it.

 **(Semi Manual):** Automatically and quickly focuses on the area around a set distance.

 **(Manual Focus):** Allows you to focus on the subject manually.



Selecting Flexible Spot AF, Semi Manual or Manual Focus

You can determine the focus position with the control button. You can also adjust the rough position by using the jog dial.



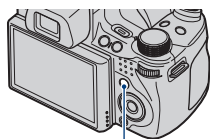

Focusing on the face of the subject (Face Detection)

The camera detects the face of the subject and focuses on it. You can select which subject takes priority when focusing.

1 Press the MENU button.



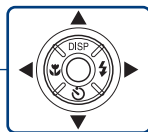
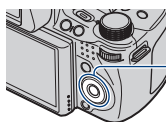

MENU button

2 Select  (Face Detection) with /// on the control button → desired mode → ●.



 (Off): Does not use Face Detection.

 (Auto): Automatically selects and focuses on a priority face.

 (Child Priority): Detects and shoots with priority on a child's face.

 (Adult Priority): Detects and shoots with priority on an adult's face.



Note

- You can select [Face Detection] only when the focus mode is set to [Multi AF] or the metering mode is set to [Multi].







Registering the priority face (Selected-face Memory)



- Press ● on the control button during Face Detection. The leftmost face is registered as the priority face, and the frame changes to an orange-colored .
- Each time you press ●, the priority face moves one face to the right. Press ● repeatedly until the orange frame () is on the face you want to register.
- To cancel the face registration (Off), move the orange frame to the rightmost face, then press ● again.

Shooting close-ups (Macro)

You can shoot beautiful close-up images of small subjects such as insects or flowers.

- 1 Press  (Macro) on the control button, then select the desired mode with   .



 **(Auto):** This camera adjusts the focus automatically from distant subjects to close-up.

Normally, put the camera in this mode.

 **(Macro On):** This camera adjusts the focus with priority on close-up subjects. Set Macro On when shooting close subjects.

Note



- Macro mode is fixed to [Auto] when the camera is in Intelligent Auto Adjustment mode or Movie Mode.

Using the self-timer

- 1 Press  (Self-Timer) on the control button, then select the desired mode with   .



 **(Self-Timer Off):** Not using the self-timer.

 **(Self-Timer 10sec):** Shooting starts after a 10-second delay. Use this setting if you want to include yourself in the image. To cancel, press  again.

 **(Self-Timer 2sec):** Shooting starts after a two-second delay. This is to prevent blurring due to unsteadiness when the shutter button is pressed.

- 2 Press the shutter button.

The self-timer lamp flashes and a beep sounds until the shutter operates.

Selecting a flash mode

- 1 Press **⚡** (Flash) on the control button, then select the desired mode with **◀/▶ → ●**.

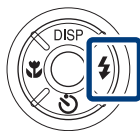

⚡AUTO (Flash Auto): Flashes when there is insufficient light or backlight.

⚡ (Flash On): Flash always operates.

⚡SL (Slow Synchro (Flash On)): Flash always operates. The shutter speed is slow in a dark place to clearly shoot the background that is out of flash light.

⚡/ (Flash Off): Flash does not operate.

Notes

- [Flash On] and [Slow Synchro (Flash On)] are not available when the camera is in Intelligent Auto Adjustment mode.
- You cannot use the flash during burst or bracket shooting.

Changing the screen display

- 1 Press DISP (screen display) on the control button, then select the desired mode with ▲/▼.



 **(Bright + Image Only):** Sets screen brighter and displays only images.

 **(Bright + Histogram):** Sets screen brighter and displays a graph of the image brightness.

 **(Bright):** Sets screen brighter and displays the information.

 **(Normal):** Sets screen to standard brightness and displays the information.



Histogram and brightness settings

A histogram is a graph showing the brightness of an image. The graph display indicates a bright image when skewed to the right side, and a dark image when skewed to the left side.

If you view images in bright outside light, adjust the screen brightness up. However, the battery power may decrease faster under such condition.

Selecting the image size to match the usage

The image size determines the size of the image file that is recorded when you take a image.

The larger the image size, the more detail will be reproduced when the image is printed on large-format paper. The smaller the image size, the more images can be recorded. Select the image size that matches the way you will view your images.

1 Press the MENU button.

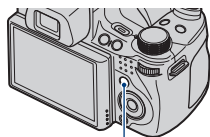

MENU button

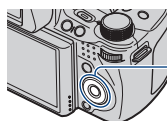

2 Select $\frac{4:3}{9M}$ (Image Size) with $\blacktriangle/\blacktriangledown/\blacktriangleleft/\blacktriangleright$ on the control button \rightarrow desired size $\rightarrow \bullet$.



When shooting still images

Image size	Usage guidelines	No. of images	Printing
$\frac{4:3}{9M}$ (3456×2592)	For prints up to A3+ size		Fine
$\frac{4:3}{5M}$ (2592×1944)	For prints up to A4 size		Rough
$\frac{4:3}{3M}$ (2048×1536)	For prints up to L/2L size		
$\frac{4:3}{VGA}$ (640×480)	For e-mail attachments	More	Rough
$\frac{3:2}{8M}$ (3456×2304)	3:2 aspect ratio as in photo prints and postcards	Less	Fine
$\frac{16:9}{6M}$ (3456×1944)	For viewing on a high-definition TV	Less	Fine
$\frac{16:9}{2M}$ (1920×1080)		More	Rough

When shooting the Sweep Panorama images

 (Standard) (Vertical direction: 3424×1920) (Horizontal direction: 4912×1080)	Shoot the Sweep Panorama images using standard size.
 (Wide) (Vertical direction: 4912×1920) (Horizontal direction: 7152×1080)	Shoot the Sweep Panorama images using wide size.

Note

- When you print images recorded with 16:9 aspect ratio, both edges may be cut off.

Number of still images that can be recorded

(Units: Images)

Capacity Size	Internal memory	"Memory Stick Duo" media formatted with this camera						
	Approx. 11 MB	256 MB	512 MB	1 GB	2 GB	4 GB	8 GB	16 GB
9M	2	51	108	221	448	885	1787	3634
5M	3	68	143	293	595	1174	2372	4821
3M	7	144	301	617	1253	2472	4991	10140
VGA	70	1383	2897	5924	12030	23730	47910	97390
3:2(8M)	2	51	107	219	445	879	1774	3607
16:9(6M)	2	51	107	219	445	879	1774	3607
16:9(2M)	11	230	482	987	2005	3955	7986	16230
Panorama Wide (horizontal)	3	60	127	259	527	1040	2101	4271
Panorama Standard (horizontal)	3	73	154	315	640	1262	2548	5180
Panorama Wide (vertical)	2	49	104	213	432	853	1723	3503
Panorama Standard (vertical)	2	52	108	222	452	892	1801	3661

Notes

- The number of still images may vary depending on the shooting conditions and the recording media.
- When the number of remaining shootable images is greater than 9,999, the ">9999" indicator appears.
- When an image shot with other cameras is played back on this camera, the image may not appear in the actual image size.

Shooting with Program Auto

Allows you to shoot with the exposure adjusted automatically (both the shutter speed and the aperture (F value)). Also you can select various settings using the menu.

- 1 Set the mode dial to **P** (Program Auto).



- 2 Press the shutter button.

■ Shooting with program shift

You can change the aperture (F value) and shutter speed combination while keeping the exposure fixed.

- ① Press the jog dial.
- ② Turn the jog dial.
“P” on the screen changes to “P*” and the shooting mode changes to program shift.
- ③ Turn the jog dial to select the aperture (F value) and shutter speed combination.
- ④ Press the shutter button.
To cancel program shift, turn the jog dial to return the indication to “P”.

Shooting moving subjects with different effects (Shutter Speed Priority Shooting)

You can shoot still images after adjusting the shutter speed manually.

- 1 Set the mode dial to **S** (Shutter Speed Priority Shooting).



- 2 Press the jog dial.

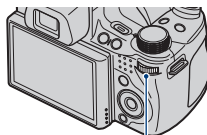

Jog dial

- 3 Turn the jog dial to select the shutter speed value.

You can select a shutter speed from 1/4000 to 30 seconds.
You can set the EV or ISO setting with the jog dial.

- 4 Press the shutter button.

Note

- The flash is set to [Flash On] or [Flash Off].



About the shutter speed



When you set the shutter speed faster, moving objects such as running people, cars or splashing water, etc., appear stopped.



When you set the shutter speed slower, the traces of moving objects such as a river current or golf swing, etc., appear. You can shoot more natural live action images.

Adjusting background blur, and shooting (Aperture Priority Shooting)

You can manually adjust the amount of light that passes through the lens.

- 1 Set the mode dial to **A** (Aperture Priority Shooting).



- 2 Press the jog dial.

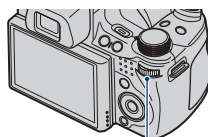

Jog dial

- 3 Turn the jog dial to select the aperture (F value).

You can select an aperture (F value) from F2.8 to F8.0.

The shutter speed is automatically adjusted from 1/2000 to 8 seconds.

You can set the EV or ISO setting with the jog dial.

- 4 Press the shutter button.

Note

- The flash is set to [Flash On], [Slow Synchro (Flash On)] or [Flash Off].



About the aperture



The lower the aperture (F value), the wider the hole that lets light pass through. The depth of focus decrease, and everything except objects within a narrow range of distance will be out of focus. This is good for portraits, etc.



The higher the aperture (F value), the smaller the hole that lets light pass through. Both objects relatively close and far away from the lens will appear sharp. This is good for landscapes, etc.

Shooting with a desired exposure (Manual Exposure Shooting)

You can shoot still images at a desired exposure after adjusting the shutter speed and aperture (F value) manually.

The camera maintains the setting even when the power is turned off. Once you set a value, you can reproduce the same exposure by simply setting the mode dial to **M** (Manual Exposure Shooting).

- 1 Set the mode dial to **M** (Manual Exposure Shooting).



- 2 Press the jog dial to select an item you desired to set.

Each time you press the jog dial, the selectable items change.

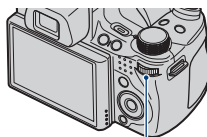

Jog dial

- 3 Turn the jog dial to set the value.

- 4 Press the shutter button.

Note

- The flash is set to [Flash On] or [Flash Off].

Shooting with reduced blur

A series of high-speed burst shots are taken with one full press of the shutter button, and image processing is applied to reduce subject blur and noise.

1 Set the mode dial to (Hand-held Twilight) or (Anti Motion Blur).

Select  (Hand-held Twilight) when you shoot night scene without a tripod.

Select  (Anti Motion Blur) when you shoot in a room.

2 Press the shutter button.

Notes

- The shutter sound beeps 6 times and an image is recorded.
- Reducing blur is less effective in the following situations:
 - Images with erratic movement
 - The main object is too close from the camera
 - Image with a repeating pattern such as sky, sandy beach or lawn
 - Image with constant change such as waves or water falls

Shooting panoramic images

Shoots multiple images and allows you to create a panoramic image from composed images while you pan the camera. You can create both up and down, and right and left panoramic images.

- 1 Set the mode dial to  (Sweep Panorama).



- 2 Hold the camera at the position where you can see the LCD screen clearly.

Press the MENU button for changing [Shooting Direction] or [Image Size] (page 58).

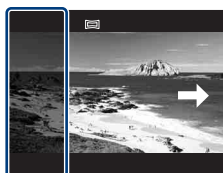

This part will not be taken.

- 3 Fully press the shutter button.

- 4 Pan the camera following the indication on the screen.

When a guidance bar reaches to the end, the shooting stops and panoramic images are recorded.



Guidance bar

Notes

- If you cannot pan the camera across the entire subject within the given time, a gray area occurs in the composed image. If this happens, move the camera fast to record a full panoramic image.
- Since several images are stitched together, the stitched part will not be recorded smoothly.
- You cannot create panoramic images in the following situations:
 - You pan the camera too fast or too slow
 - There is too much camera shake
 - You pan the camera in a different direction from the setting
- Under low light conditions, panoramic images may be blurred.



Tips for shooting a panoramic image

Horizontal direction

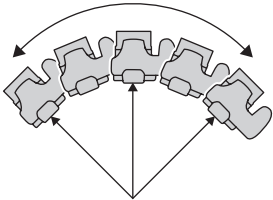

Vertical direction

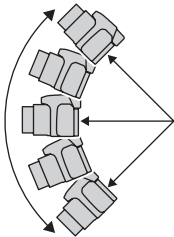

- Pan the camera in an arc with a constant velocity.
- Pan the camera in the same direction as the indications on the LCD screen. If the camera shakes while the panning, the joint may not be recorded smoothly.
- Pan the camera keeping the radius of the arc as short as possible.
- Determine the scene and press the shutter button halfway, so that you can lock the exposure and white balance.
- When the whole angle of panoramic shooting and the locked angle are extremely different in brightness, color and focus, the shooting will not be successful. If this happens, change lock angle and shoot again.
- Sweep Panorama is not suitable for the following situations:
 - Objects are moving
 - Objects are too close to the camera
 - Image with a repeating pattern such as sky, sandy beach, or lawn
 - Image with constant change such as waves or water falls
- Under lights that flicker such as fluorescent light, the brightness or color of the combined image is not always the same.



Playing back for panoramic images

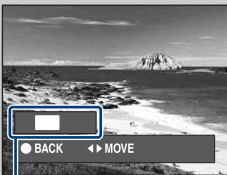

Shows the displayed area of the whole panoramic image.

- You can scroll panoramic images by pressing ● on the control button while panoramic images are played back.
- Press ◀▶ to scroll images to the horizontal position.
- Press ▲▼ to scroll images to the vertical position.



- Panoramic images are played back with the supplied software “PMB.”

Shooting continuously (High-speed burst shooting/Exposure bracket)

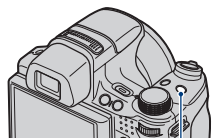



- 1 Press the /BRK (Burst/Bracket) button.

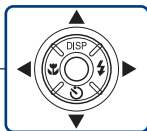
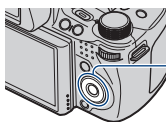

/BRK (Burst/Bracket) button

- 2 Select a shooting mode with /  on the control button, and press .



-  **(Normal)**: Shoots a single image.
-  **(Burst(High))**: Shoots up to 10 images per second in succession.
-  **(Burst(Mid))**: Shoots up to 5 images per second in succession.
-  **(Burst(Low))**: Shoots up to 2 images per second in succession.
- BRK (Bracket)**: Shoots 3 images with different exposure.

- 3 Press the shutter button.

Note

- The number of shots taken in one second may decrease because some shooting settings make the shutter speed slow.



About the recording of High-speed burst shooting images

After shooting High-speed burst images, the shot images are displayed in frames on the LCD screen. When all the images are fitted in the frames, recording completes.

You can stop the recording by selecting [OK] with  on the control button.

When stopped, the image displayed in index and images in the image processing are recorded.



Playing back grouped burst images

Burst shots are recorded in a group and you can play them back automatically.

Display Main Image Only



When a face is detected in burst images, a most suitable image is displayed as a main image. When a face is not detected, the first image will become a main image. The main image can be changed.

Display All



The burst images can be displayed in a list.

- ① Press **●** on the control button.
Burst groups are displayed as thumbnail images.
- ② Select images with **◀/▶**.
Display or hide the index with **▼**, and press **●** to go back to single playback.

- [Date View] and [Event View] can group burst images.

Using the Shooting mode that matches the scene (Scene Selection)

- 1 Set the mode dial to SCN (Scene Selection).

A list of Scene Selection modes is displayed.



- 2 Select the desired mode with ▲/▼/◀/▶ on the control button → ●.

If you want to switch to another scene, press the MENU button.

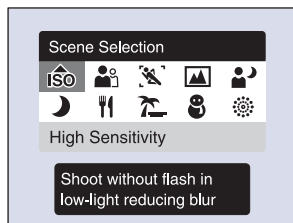

ISO (High Sensitivity): Shoots images without a flash even in low lighting.



Portrait: Shoots with backgrounds blur away, and the subject is sharpened.



Advanced Sports Shooting: Shoots subjects with fast movements such as sports.



Landscape: Shoots with the focus on a distant subject.



Twilight Portrait: Shoots sharp images of people in a dark place without losing the nighttime atmosphere.



Twilight: Shoots night scenes without losing the nighttime atmosphere.



Gourmet: Shoots food arrangements in delicious color.



Beach: Shoots seaside or lakeside scenes with the blueness of the water captured more vividly.



Snow: Shoots snow scenes in white more clearly.



Fireworks: Shoots fireworks in all their splendor.







Note

- The flash does not operate in some modes.

Image size

The larger the image size, the higher the image quality. The higher the amount of data used per second (average bit rate), the smoother the playback image.

Movie image size	Average bit rate	Usage guidelines
 1440×1080(Fine)	12 Mbps	Shoot highest quality movie for display on HDTV (1080)
 1440×1080(Standard)	7 Mbps	Shoot standard quality movie for display on HDTV (1080)
 1280×720	6 Mbps	Shoot standard quality movie for display on HDTV (720)
 VGA	3 Mbps	Shoot at an image size suitable for WEB upload

Maximum recording time

The table below shows the approximate maximum recording times. These are the total times for all movie files. Continuous shooting is possible for approximately 29 minutes.



(Units: hour : minute : second)

Capacity Size	Internal memory	"Memory Stick Duo" media formatted with this camera						
	Approx. 11 MB	256 MB	512 MB	1 GB	2 GB	4 GB	8 GB	16 GB
1440×1080(Fine)	–	–	0:05:00	0:10:20	0:21:10	0:41:50	1:24:50	2:52:30
1440×1080(Standard)	–	0:03:50	0:08:20	0:17:20	0:35:40	1:10:30	2:22:20	4:49:40
1280×720	–	0:04:40	0:09:50	0:20:20	0:41:30	1:22:10	2:46:10	5:38:00
VGA	0:00:10	0:08:40	0:18:20	0:37:40	1:16:50	2:31:50	5:07:00	10:24:10

Notes

- The recording time may vary depending on the shooting conditions and the recording media.
- The continuous shooting time differs according to the shooting conditions (temperature, etc.). The value above is based on screen brightness set to [Normal].
- Movies with the size set to [1440×1080(Fine)], [1440×1080(Standard)] or [1280×720] can only be recorded on a "Memory Stick PRO Duo" media.
- The size of a movie file is limited to approx. 2 GB. During recording, movie recording stops before reaching 29 minutes when the file size of the movie reaches approx. 2 GB.

Viewing an enlarged image (Playback zoom)

- 1 Press the  (Playback) button to display an image, then turn the  (Playback zoom) lever to the T side.

The image is enlarged twice the previous size, at the center of the image.

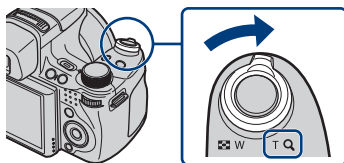

- 2 Adjust the zoom scale and position.



 (Playback zoom) lever: Zooms in by turning to the T side. Zooms out by turning to the W side.

 on the control button: Adjusts the position.



Shows the displayed area of the whole image

Searching for an image (Image Index)

- 1 Press the  (Playback) button to display an image, then turn the  (Index) lever to the W side.

- Turn  (Index) lever again to display an index screen with even more images.

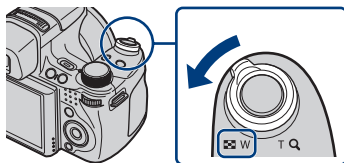

- 2 Select an image with  on the control button.

- To return to the single-image screen, press .

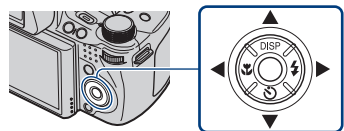





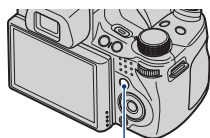

Selecting the display format (View Mode)

Allows you to select the display format for viewing multiple images when using “Memory Stick Duo” media.

- 1 Press the  (Playback) button to display an image, then press the MENU button.



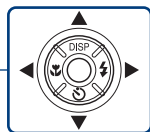
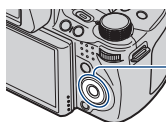

MENU button

- 2 Select  (View Mode) with /// on the control button → desired mode → .



 **(Date View):** Displays images by the date.

 **(Event View):** Analyzes the dates shots and frequency, automatically organizes the images into groups and displays them.

 **(Favorites):** Displays images registered as Favorites.

 **(Folder View):** Displays and organizes images by folders.

Note



- When you cannot play back images recorded with other cameras, view the images in [Folder View].

Deleting images

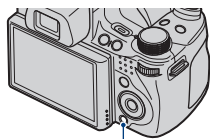
- 1 Press  (Playback) button to display an image, then press  (Delete) button.



 (Delete) button

- 2 Press / on the control button to select the desired setting.

All in Date Range: You can delete all images in the displayed date range.

According to the View Mode, this item will be [All in This Folder], [All in Event], [All In This Group] or [All Except Main Image].

Multiple Images: You can select and delete multiple images. Select the images, press , and then press the MENU button to delete.

This Image: You can delete the currently displayed image.





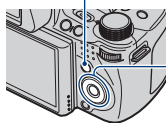





Exit: Cancels the deletion.

MENU button



Deleting all images (Format)

You can delete all data stored on “Memory Stick Duo” media or the internal memory. If a “Memory Stick Duo” media is inserted, all data stored on the “Memory Stick Duo” media are deleted. If no “Memory Stick Duo” media is inserted, all data stored in the internal memory are deleted. Formatting permanently deletes all data, including protected images, and the data cannot be recovered.

- ① Press the MENU button.
- ② Select  (Settings) with  on the control button, and press .
- ③ Select  (“Memory Stick” Tool) or  (Internal Memory Tool) with , , ,  [Format] → .
- ④ Select [OK] and press .

Viewing images on a TV

- 1 Connect the camera to the TV with the cable for multi-use terminal (supplied).

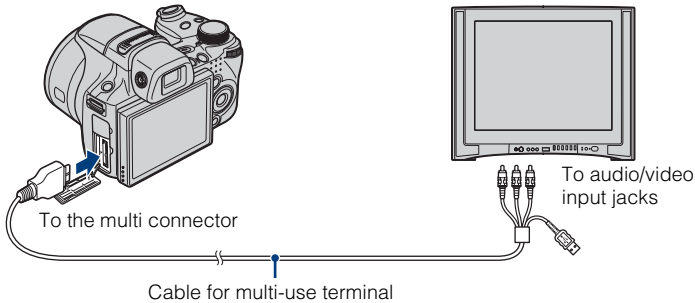

Note



- The Video Out setting is set to NTSC mode at the factory to let you enjoy optimum movie image quality. When images do not appear or appear jittery on your TV, you may be using a PAL-only TV. Try switching the Video Out setting to PAL (page 63).





Viewing images on an HD (High Definition) TV

You can view images recorded on the camera by connecting the camera to an HD (High Definition) TV with an HDMI cable (sold separately) or an HD Output Adaptor Cable (sold separately).

When you use the HDMI cable:

- Press MENU →  (Settings) →  (Main Settings) → [HDMI Resolution] → [Auto] or [1080i].
- Use an HDMI cable with the HDMI logo mark.

When you use the HD Output Adaptor Cable:

- Press MENU →  (Settings) →  (Main Settings) → [COMPONENT] → [HD(1080i)].
- Use a Type2d-compliant HD Output Adaptor Cable.

Printing still images

If you have a PictBridge compliant printer, you can print images by the following procedure.

First, set the camera to enable USB connection between the camera and the printer.

1 Connect the camera to the printer with the cable for multi-use terminal (supplied).

2 Turn on the printer.

After the connection is made, the  indicator appears on the LCD screen.

3 Press MENU →  (Print) with ▲/▼/◀/▶ on the control button → desired mode → ●.

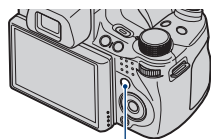

MENU button

 (This Image): Print the currently displayed image.

 (Multiple Images): Press ◀/▶ to display the image, then ●.

4 Select the desired setting item, then [OK] → ●.

The image is printed.



Notes

- If it was impossible to connect to the printer, be sure to set [USB Connect] under  (Main Settings) to [PictBridge].
- Panoramic images may not be printed depending on the printer.



Printing at a shop

You cannot print images stored in the internal memory at a print shop directly from the camera. Copy the images to a “Memory Stick Duo” media, then take the “Memory Stick Duo” media to the print shop.

How to copy: Press MENU →  (Settings) →  (“Memory Stick” Tool) → [Copy] → [OK].

For details, consult your photo printing service shop.



Superimposing dates on images

This camera does not include a function for superimposing a date on an image. The reason for this is to prevent the date from being duplicated during printing.

Printing at a shop:

You can ask that images be printed with a date superimposed. For details, consult with a photo printing service shop.

Printing at home:

Connect to a PictBridge-compliant printer, and press the MENU button, then set [Print] → [Date] to [Date] or [Day&Time].

Superimposing dates on images using PMB:

With the supplied “PMB” software installed on a PC (page 53), you can directly superimpose the date on an image. However, note that when images with a superimposed date are printed, the date may be duplicated depending on print settings. For details on “PMB,” see the “PMB Guide” (page 54).

Using the camera with a computer

■ Using “PMB (Picture Motion Browser)”

You can enjoy the recorded images more than ever by taking advantage of the software, and “PMB” is included on a CD-ROM (supplied).

There are more functions, in addition to those listed below, for enjoying your images. For details, see the “PMB Guide” (page 54).

Import to computer



Media service

Uploading the image to the media service.

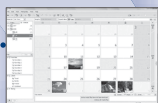

Calendar

Viewing images in a calendar.



Print

Printing images with date stamps.

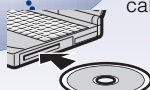

CD/DVD

Creating a data disc using a CD burner drive or DVD burner drive.

Export to camera



Exporting images to a “Memory Stick Duo” media and viewing them.

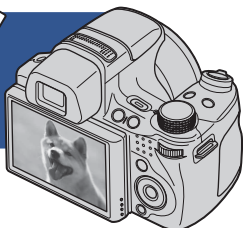

Note

- “PMB” is not compatible with Macintosh computers.

■ Stage 1: Installing the “PMB” (supplied)

You can install the software (supplied) using the following procedure. When you install “PMB,” “Music Transfer” is also installed.

- Log on as Administrator.

1 Check your computer environment.

Recommended environment for using “PMB” and “Music Transfer”

OS (pre-installed): Microsoft Windows XP*¹ SP3/Windows Vista*² SP1

CPU: For playing/editing still images: Intel Pentium III 800 MHz or faster

For playing/editing the High Definition movies:

[1440×1080(Fine)]: Intel Core Duo 2.0 GHz or faster/ Intel Core 2 Duo 1.66 GHz or faster

[1440×1080(Standard)]: Intel Pentium D 2.8 GHz or faster/ Intel Core Duo 1.66 GHz or faster/ Intel Core 2 Duo 1.20 GHz or faster

Memory: 512 MB or more (For playing/editing the High Definition movies: 1 GB or more)

Hard Disk (Disk space required for installation): Approximately 500 MB

Display: Screen resolution: 1,024 × 768 dots or more

Video memory: 32 MB or more (Recommended: 64 MB or more)

*¹ 64-bit editions and Starter (Edition) are not supported.

*² Starter (Edition) is not supported.

2 Turn on your computer, and insert the CD-ROM (supplied) into the CD-ROM drive.

The installation menu screen appears.

3 Click [Install].

The “Choose Setup Language” screen appears.



4 Follow the instructions on the screen to complete the installation.

5 Remove the CD-ROM after the installation is complete.



■ Stage 2: Importing images to your computer using “PMB”

1 Insert a fully charged battery pack to the camera, then press the  (Playback) button.

2 Connect the camera to your computer.

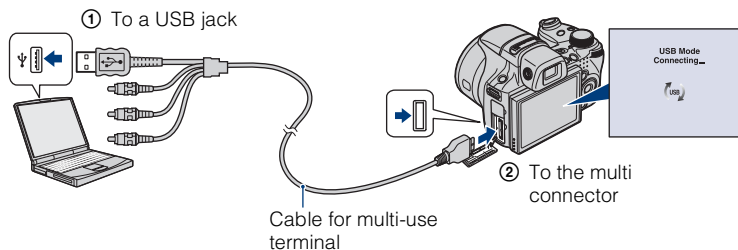
“Connecting...” appears on the screen of the camera.



-  is displayed on the screen during the communication session. Do not operate the computer while the indicator is displayed. When the indicator changes to , you can start using the computer again.

3 Click the [Import] button.

For details, see the “PMB Guide.”

■ Stage 3: Viewing “PMB Guide”

1 Double-click the  (PMB Guide) icon on the desktop.

- To access the “PMB Guide” from the start menu: Click [Start] → [All Programs] → [Sony Picture Utility] → [Help] → [PMB Guide].

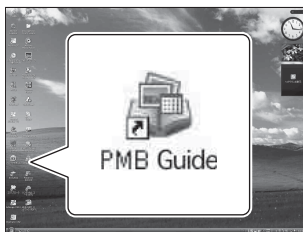

Notes

- Do not disconnect the cable for multi-use terminal from the camera while the camera is operating or while “Accessing...” appears on the screen of the camera. Doing so may corrupt the data.
- When using a battery with little remaining charge, you may not be able to transfer the data or the data may be corrupted. Using the AC Adaptor (sold separately) is recommended.

■ Using the camera with your Macintosh computer

You can copy images to your Macintosh computer. However, “PMB” is not compatible. When images are exported to “Memory Stick Duo” media, view them in [Folder View]. You can install “Music Transfer” on your Macintosh computer.

Recommended computer environment

The following environment is recommended for a computer connected to the camera.

Recommended environment for importing images

OS (pre-installed): Mac OS 9.1/9.2/ Mac OS X (v10.1 to v10.5)

USB jack: Provided as standard

Recommended environment for using “Music Transfer”

OS (pre-installed): Mac OS X (v10.3 to v10.5)

Memory: 64 MB or more (128 MB or more is recommended)

Hard Disk (Disk space required for installation): Approximately 50 MB



Changing the operation sounds

You can set the sound produced when you operate the camera.

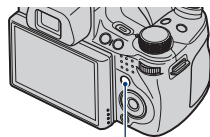
- 1 Press the MENU button.



MENU button

- 2 Select  (Settings) with  on the control button, then press .

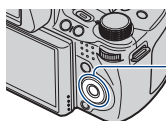

- 3 Select  (Main Settings) with , , , or  on the control button, then press [Beep] → desired mode → .

Shutter: Turns on the shutter sound when you press the shutter button.

High/Low: Turns on the beep/shutter sound when you press the control/shutter button. If you want to lower the volume, select [Low].

Off: Turns off the beep/shutter sound.

Setting the custom button

You can set the commonly-used function selecting from Smile Shutter, White Balance or Metering Mode to the custom button and set easily when shooting. The default setting for the custom button is [Smile Shutter].

1 Press the MENU button.

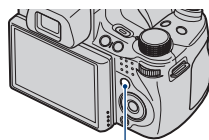

MENU button

2 Select  (Settings) with ▼ on the control button, then press ●.

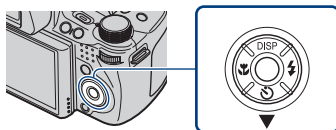

3 Select  (Shooting Settings) with ▲/▼/◀/▶ → [Custom Button] → desired mode → ●.

Smile Shutter: Shoots using the Smile Shutter (default setting).

White Balance: Displays the White Balance setting screen.



Metering Mode: Displays the Metering Mode setting screen.

Note

- Custom Button is fixed to [Smile Shutter] in **EASY** (Easy Shooting) and Demo Mode.

Using the MENU items

Displays available functions for easy setting when the camera is in shooting or playback mode. Only the items that are available for each mode are displayed on the screen.

Select  (Settings) →  [Main Settings] → [Initialize] to initialize the settings to the default setting.

- 1 Press the MENU button to display the menu screen.

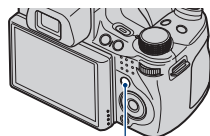

MENU button

- 2 Select the desired menu item with ▲/▼/◀/▶ on the control button. During playback, confirm by pressing ●.

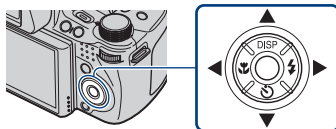

- 3 Press the MENU button to turn off the menu screen.











MENU in shooting mode

Item	Description
Movie shooting mode	Changes the setting according to the selected scene when shooting movies. (Auto/ High Sensitivity)
Shooting Direction	Sets the direction of moving the camera. (Right/ Left/ Up/ Down)
Image Size	Sets the image size. (4:3 9M / 4:3 5M / 4:3 3M / VGA / 3:2 8M / 16:9 6M / 16:9 2M) (Standard/ Wide) (1080 FINE 1440×1080(Fine)/ 1080 STD 1440×1080(Standard)/ 720 1280×720/ VGA)
White Balance	Adjusts color tones according to the surrounding light conditions. (AUTO Auto/ Daylight/ Cloudy/ Fluorescent Light 1, Fluorescent Light 2, Fluorescent Light 3/ Incandescent/ Flash/ One Push/ SET One Push Set)
Metering Mode	Sets which part of the subject to measure to determine the exposure. (Multi/ Center/ Spot)
Bracket Set	Sets the shooting with Bracket. (±0.3 EXP±0.3/ ±0.7 EXP±0.7/ ±1.0 EXP±1.0/ BRK White Balance/ BRK Color Mode)
Scene Recognition	Automatically detects the shooting conditions and then takes the shot. (SCN Auto/ SCN+ Advanced)
Smile Detection Sensitivity	Sets the level of sensitivity to detect smile. (Big Smile/ Normal Smile/ Slight Smile)
Face Detection	Selects the priority subject for adjusting the focus when using Face Detection. (OFF Off/ AUTO Auto/ Child Priority/ Adult Priority)
Flash Level	Adjusts the amount of flash light. (-2.0EV to +2.0EV)
Anti Blink	Sets Anti Blink function. (AUTO Auto/ OFF Off)
Red Eye Reduction	Sets to reduce the red-eye phenomenon. (Red Eye Reduction Auto/ ON On/ OFF Off)
DRO	Optimizes the brightness and contrast. (OFF Off/ DRO standard/ DRO Plus)
Noise Reduction	Adjusts the image resolution and the noise balance. (NR ₋ -/ NR _{STD} Standard/ NR ₊ +)
Color Mode	Changes the vividness of the image or adds special effects. (Normal/ Vivid/ Real/ Sepia/ B & W)

Item	Description
Color Filter	Adds color effects as if you use a color filter. (Off/ Red/ Green/ Blue/ Warm/ Cool)
Color Saturation	Adjusts the brightness of the image. (-/ Standard/ +)
Contrast	Adjusts the contrast of the image. (-/ Standard/ +)
Sharpness	Adjusts the sharpness of the image. (-/ Standard/ +)
SteadyShot	Selects the anti-blur mode. (Shooting/ Continuous/ Off)
(Settings)	Changes the camera settings.

MENU in viewing mode

Item	Description
(Slideshow)	Plays back images in succession along with effects and music. (Continuous Playback/ Slideshow with music)
(Date List)	Selects the playback date list.
(Event List)	Selects the event group to be played back.
(View Mode)	Switches the View Mode. (Date View/ Event View/ Favorites/ Folder View)
(Filter by Faces)	Plays back images filtered to meet certain conditions. (Off/ All people/ Children/ Infants/ Smiles)
(Change Main Image)	Set the burst images to display on the screen.
(Add / Remove Favorites)	Adds images to Favorites or removes images from Favorites. (This Image/ Multiple Images/ Add All in Date Range*/ Remove All in Date Range*) * The displayed text differs according to each View Mode.
(Display Burst Group)	Select how to display the burst images on the screen. (Display Main Image Only/ Display All)
(Retouch)	Retouches still images. (Trimming/ Red Eye Correction/ Unsharp masking/ Soft Focus/ Partial Color/ Fisheye Lens/ Cross Filter/ Radial Blur/ Retro/ Happy Faces)
(Multi-Purpose Resize)	Changes the image size according to usage. (HDTV/ Blog/E-mail)
(Delete)	Deletes images. (This Image/ Multiple Images/ All in Date Range*) * The displayed text differs according to each View Mode.

Item	Description
 (Protect)	Prevents accidental erasure. ( This Image/  Multiple Images)
DPOF	Adds a Print order mark to the image you want to print in a “Memory Stick Duo” media. ( This Image/  Multiple Images)
 (Print)	Prints images using a PictBridge compliant printer. ( This Image/  Multiple Images)
 (Rotate)	Rotates a still image.
 (Select Folder)	Selects the folder for viewing images.
 (Settings)	Changes settings other than shooting settings.

Using the (Settings) items



You can change the default settings of the camera.

 (Shooting Settings) are displayed only when settings have been entered from shooting mode.

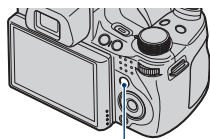
- 1 Press the MENU button to display the menu screen.





MENU button

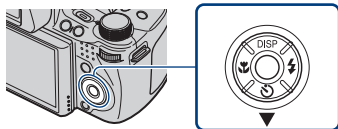

- 2 Select  (Settings) with  on the control button, and confirm by pressing .



- 3 Select the desired item with , , , or  on the control button, then press .

- 4 Press the MENU button to turn off the setting screen.

Category	Item	Description
 (Shooting Settings)	AF Illuminator	The AF illuminator supplies fill light to focus more easily on a subject in dark surroundings.
	Grid Line	Sets whether or not to display the grid lines on the screen.
	Digital Zoom	Selects the digital zoom mode.
	Conversion Lens	Sets for achieving appropriate focus when attaching a conversion lens.
	Flash Sync.	Selects the timing to flash.
	Auto Orientation	When the camera is rotated to shoot a portrait (vertical) image, the camera records its position change and displays the image in the portrait position.
	Auto Review	Displays the recorded image on the screen for approximately two seconds immediately after shooting a still image.
	Expanded Focus	Displays the center part of the image double while using the Manual Focus.
	Custom Button	Sets the desired function to the custom button.
 (Main Settings)	Beep	Selects or turns off the sound produced when you operate the camera.
	Language Setting	Selects the language to be used in menu items, warnings and messages.
	Function Guide	Selects whether or not to display the function guide when you operate the camera.
	Initialize	Initializes settings to their default settings.
	Demo Mode	Sets whether to view a demonstration of the Smile Shutter and Scene Recognition.
	HDMI Resolution	Sets the resolution to be output to a TV when the camera is connected to a High Definition TV.
	CTRL FOR HDMI	Enables you to operate the camera using the TV remote controller when your camera is connected to a "BRAVIA" Sync compatible TV.
	COMPONENT	Selects the video signal output type according to the TV connected.
	Video Out	Sets the video signal output according to the TV color system of the connected video equipment.
	Wide Zoom Display	Plays back still images at a 4:3 or 3:2 aspect ratio as a 16:9 aspect ratio on HD (High Definition) TV.
	USB Connect	Selects the USB mode when connecting the camera to a computer or a PictBridge-compliant printer using the cable for multi-use terminal.
	Download Music	Changes music files using "Music Transfer".
	Format Music	Deletes all background music files stored in the camera.

Category	Item	Description
 ("Memory Stick" Tool)	Format	Formats the "Memory Stick Duo" media.
	Create REC.Folder	Creates a folder in "Memory Stick Duo" media for recording images.
	Change REC.Folder	Changes the folder currently used for recording images.
	Delete REC.Folder	Deletes folders in "Memory Stick Duo" media.
	Copy	Copies all images in the internal memory to "Memory Stick Duo" media.
	File Number	Selects the method used to assign file numbers to images.
 (Internal Memory Tool)	Format	Formats the internal memory.
	File Number	Selects the method used to assign file numbers to images.
 (Clock Settings)	Area Setting	Adjusts the time to the local time of the selected area.
	Date & Time Setting	Sets the date and time.

Learning more about the camera (“Cyber-shot Handbook”)

“Cyber-shot Handbook”, which explains how to use the camera in detail, is included on the CD-ROM (supplied). Refer to it for in-depth instructions on the many functions of the camera.

- You need Adobe Reader to read “Cyber-shot Handbook”. If it is not installed on your computer, you can download it from web page: <http://www.adobe.com/>

■ For Windows users

1 Turn on your computer, and insert the CD-ROM (supplied) into the CD-ROM drive.

2 Click “Cyber-shot Handbook”.
“Cyber-shot Step-up Guide”, which contains information on accessories for the camera, is installed at the same time.



3 Start “Cyber-shot Handbook” from the shortcut on the desktop.

■ For Macintosh users

1 Turn on your computer, and insert the CD-ROM (supplied) into the CD-ROM drive.

2 Select the [Handbook] folder and copy “Handbook.pdf” stored in the [GB] folder to your computer.

3 After copying is complete, double-click “Handbook.pdf.”

List of icons displayed on the screen

Icons are displayed on the screen to indicate the camera status.

You can change the screen display using DISP (screen display) on the control button (page 30).

When shooting still images

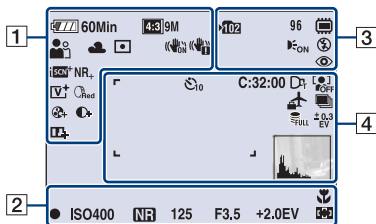

- The icons are limited in **EASY** (Easy Shooting) mode.

When shooting movies

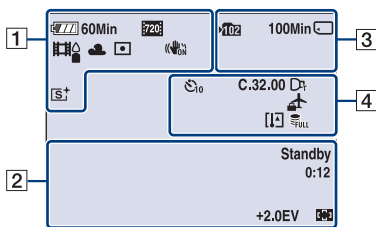

When playing back

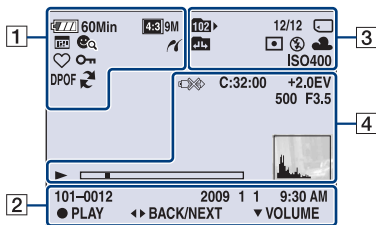

1

Display	Indication
60Min	Battery remaining
	Low battery warning
4:3 9M 4:3 5M 4:3 3M 4:3 VGA 3:2 6M 16:9 6M 16:9 2M 1080 FINE 1080i STD 720i VGA: STD WIDE	Image Size
ISO, Person, Handheld, Anti Motion Blur, Sweep Panorama, Sun, Moon, Twilight, Anti Motion Blur, Sweep Panorama	Scene Selection
i P S A M Handheld, Anti Motion Blur, Sweep Panorama	Mode dial (Intelligent Auto Adjustment, Program Auto, Shutter Speed Priority Shooting, Aperture Priority Shooting, Manual Exposure Shooting, Hand-held Twilight, Anti Motion Blur, Sweep Panorama)
	Movie shooting mode
	White Balance
	Metering Mode
	SteadyShot
	Vibration warning
i SCN+	Scene Recognition
	Scene Recognition icon
D-R D-R Plus	DRO
NR_ NR+	Noise Reduction
Red Green Blue Warm Cool	Color Filter

Display	Indication
	Color Saturation
	Contrast
	Sharpness
	Smile Detection Sensitivity indicator
	Zoom scaling
	Color Mode
	PictBridge connecting
	View Mode
	Display Burst Group
	Main image in the burst group
	Filter by Faces
	Favorites
	Protect
DPOF	Print order (DPOF)
	PMB export
Qx2.0	Playback zoom

2

Display	Indication
	AE/AF lock
ISO400	ISO number
NR	NR slow shutter
125	Shutter speed
F3.5	Aperture value
+2.0EV	Exposure value
	AF range finder frame indicator
	Macro
REC Standby	Recording a movie/Standby a movie
0:12	Recording time (m:s)
101-0012	Folder-file number
2009 1 1 9:30 AM	Recorded date/time of the playback image
	Function guide for playing image
	Function guide for playing image
	Selecting images
	Adjusting volume
	Semi Manual
	Manual Focus
	Manual Focus bar

3

Display	Indication
	Recording folder
	Playback folder
96	Number of recordable images
12/12	Image number/Number of images recorded in selected folder
100Min	Recordable time
	Recording/Playback Media ("Memory Stick Duo" media, internal memory)
	Changing folder
	AF Illuminator
	Red Eye Reduction
	Metering Mode
	Flash mode
	Flash charging
	White Balance
ISO400	ISO number

4

Display	Indication
	Self-Timer
C:32:00	Self-diagnosis display
	Destination
	Overheating warning
	Conversion Lens
	Face Detection
	Burst/Bracket
BRK	Management file full
	Management file full
	Bracket Set
	AF range finder frame
	Spot metering cross hair
+2.0EV	Exposure value
500	Shutter speed
F3.5	Aperture value
	PictBridge connecting
	Playback
	Playback bar
35° 37' 32" N 139° 44' 31" E	Latitude and Longitude display
	Histogram • appears when histogram display is disabled.
	Volume

Troubleshooting

If you experience trouble with the camera, try the following solutions.

1 Check the items below, and refer to “Cyber-shot Handbook” (PDF).

If a code such as “C/E:□□:□□” appears on the screen, refer to “Cyber-shot Handbook.”

2 Remove the battery pack, wait for about one minute, re-insert the battery pack, then turn on the power.

3 Press the RESET button using a fine-tipped object, and turn on the power (page 12).

If you do the operation above, the date and time setting is cleared.

4 Consult your Sony dealer or local authorized Sony service facility.

On repairing cameras with internal memory or Music files function included, data in the camera may be checked on minimum necessity to verify and improve the malfunction symptoms. Sony will not copy or save any of those data.

Battery pack and power

Cannot insert the battery pack.

- Insert the battery pack correctly by pushing the battery eject lever (page 15).

Cannot turn on the camera.

- After inserting the battery pack into the camera, it may take a few moments for the camera to power up.
- Insert the battery pack correctly (page 15).
- The battery pack is discharged. Insert a charged battery pack (page 13).
- The battery pack is dead. Replace it with a new one.
- Use a recommended battery pack.

The power turns off suddenly.

- Depending on the camera and battery temperature, the power may turn off automatically to protect the camera. In this case, a message is displayed on the LCD screen before the power turns off.
- If you do not operate the camera for about three minutes while the power is on, the camera turns off automatically to prevent wearing down the battery pack. Turn on the camera again (page 18).
- The battery pack is dead. Replace it with a new one.

The remaining charge indicator is incorrect.

- The battery charge will quickly get used up and the actual remaining battery charge will be lower than the indicator in the following cases:
 - When you use the camera in an extremely hot or cold location.
 - When you use the flash and zoom frequently.
 - When you repeatedly turn the power on and off.
 - When you set the screen brightness higher using DISP (screen display) settings.
- A discrepancy arose between the remaining charge indicator and the actual remaining battery charge. Fully discharge the battery pack once, then charge it to correct the indication.
- The battery pack is discharged. Insert the charged battery pack (page 13).
- The battery pack is dead. Replace it with a new one.

Cannot charge the battery pack while it is inside the camera.



- You cannot charge the battery pack using the AC Adaptor (sold separately). Use the battery charger (supplied) to charge the battery.

The CHARGE lamp flashes while charging the battery.

- Remove and reinsert the battery pack, making sure it is installed correctly.
- The temperature may be inappropriate for charging. Try charging the battery pack again within the proper charging temperature range (10 °C to 30 °C (50 °F to 86 °F)).

Shooting still images/movies

Cannot record images.

- Check the free capacity of the internal memory or “Memory Stick Duo” media (pages 32, 45). If it is full, do one of the following:
 - Delete unnecessary images (page 48).
 - Change the “Memory Stick Duo” media.
- You cannot record images while charging the flash.
- When shooting a still image, set the mode dial to other than  (Movie Mode).
- Set the mode dial to  (Movie Mode) when shooting movies.
- You can record movies with an image size of [1440×1080(Fine)], [1440×1080(Standard)] or [1280×720] on “Memory Stick PRO Duo” media. When using recording media other than “Memory Stick PRO Duo” media, set the movie image size to [VGA].
- The camera is in Smile Shutter demonstration mode. Set [Demo Mode] to [Off].

Cannot create panoramic images.

- Pan the camera as the guidance bar with a constant velocity. You cannot create panoramic images in the following situations:
 - Pan the camera too fast or too slow.
 - Pan the camera in the different direction from the setting.
- If there is too much camera shake during panning, the shooting stops. Hold the camera firmly.

Cannot play back images.

- Press the  (Playback) button (page 21).
- The folder/file name has been changed on your computer.
- No guarantees are made for playing back, on this camera, files containing images which were processed on a computer or images which were shot using other cameras.
- The camera is in USB mode. Delete the USB connection.
- You may not be able to play back some images stored on the “Memory Stick Duo” media shot using other cameras. Play such images in Folder View (page 47).
- This is caused by copying images on your computer to the “Memory Stick Duo” media without using the “PMB.” Play such images in Folder View (page 47).

Precautions

Do not use/store the camera in the following places

- In an extremely hot, cold or humid place
In places such as in a car parked in the sun, the camera body may become deformed and this may cause a malfunction.
- Under direct sunlight or near a heater
The camera body may become discolored or deformed, and this may cause a malfunction.
- In a location subject to rocking vibration
- Near strong magnetic place
- In sandy or dusty places
Be careful not to let sand or dust get into the camera. This may cause the camera to malfunction, and in some cases this malfunction cannot be repaired.

On cleaning

Cleaning the LCD screen

Wipe the screen surface with an LCD cleaning kit (sold separately) to remove fingerprints, dust, etc.

Cleaning the lens

Wipe the lens with a soft cloth to remove fingerprints, dust, etc.

Cleaning the camera surface

Clean the camera surface with a soft cloth slightly moistened with water, then wipe the surface with a dry cloth. To prevent damage to the finish or casing:

- Do not expose the camera to chemical products such as thinner, benzine, alcohol, disposable cloths, insect repellent, sunscreen or insecticide.
- Do not touch the camera with any of the above on your hand.
- Do not leave the camera in contact with rubber or vinyl for a long time.

On operating temperatures

Your camera is designed for use under the temperatures between 0 °C and 40 °C (32 °F and 104 °F). Shooting in extremely cold or hot places that exceed this range is not recommended.

On moisture condensation

If the camera is brought directly from a cold to a warm location, moisture may condense inside or outside the camera. This moisture condensation may cause a malfunction of the camera.

If moisture condensation occurs

Turn off the camera and wait about an hour for the moisture to evaporate. Note that if you attempt to shoot with moisture remaining inside the lens, you will be unable to record clear images.

On the internal rechargeable backup battery

This camera has an internal rechargeable battery for maintaining the date and time and other settings regardless of whether the power is on or off.

This rechargeable battery is continually charged as long as you are using the camera. However, if you use the camera for only short periods, it discharges gradually, and if you do not use the camera at all for about one month it becomes completely discharged. In this case, be sure to charge this rechargeable battery before using the camera.

However, even if this rechargeable battery is not charged, you can still use the camera, but the date and time will not be indicated.

Charging method of the internal rechargeable backup battery

Insert charged battery pack in the camera, and then leave the camera for 24 hours or more with the power off.

Specifications

Camera

[System]

Image device: 7.63 mm (1/2.4 type) Exmor CMOS sensor

Total pixel number of camera:

Approx. 10.3 Megapixels

Effective pixel number of camera:

Approx. 9.1 Megapixels

Lens: G-series 20x zoom lens

f = 5.0 mm – 100.0 mm (28 mm – 560 mm (35 mm film equivalent))

F2.8 (W) – F5.2 (T)

Shooting movies (16:9): 31 mm – 620 mm

Shooting movies (4:3): 38 mm – 760 mm

Exposure control: Automatic exposure, Shutter speed priority, Aperture priority, Manual exposure, Scene selection (10 modes)

White balance: Automatic, Daylight, Cloudy, Fluorescent 1,2,3, Incandescent, Flash, One push

File format (DCF compliant):

Still images: JPEG (DCF Ver. 2.0, Exif Ver. 2.21, MPF Baseline) compliant, DPOF compatible

Movies: MPEG-4 AVC/H.264 compliant (stereo)

Recording media: Internal Memory

(approx. 11 MB), “Memory Stick Duo” media

Flash: Flash range (ISO sensitivity

(Recommended Exposure Index) set to Auto):

Approx. 0.3 m to 9.2 m (11 7/8 inches to

30 feet 2 1/4 inches) (W)/

approx. 1.5 m to 5.1 m (4 feet 11 1/8 inches to

16 feet 8 7/8 inches) (T)

Viewfinder: Electric view finder (color)

[Input and Output connectors]

Multi use terminal Type2d: (AV-out(SD/HD Component)/HDMI/USB)

Video output

Audio output (stereo)

HDMI output

USB communication

USB communication:

Hi-Speed USB (USB 2.0 compliant)

[LCD screen]

LCD panel: 7.5 cm (3.0 type) TFT drive

Total number of dots: 230 400 (960 × 240) dots

[Finder]

Panel: 0.5 cm (0.2 type)

Total number of dots:

Approx. 201 000 dots equivalent

[Power, general]

Power: Rechargeable battery pack

NP-FH50, 6.8 V

Power consumption (during shooting, LCD screen on): 1.2 W

Operating temperature: 0 °C to 40 °C (32 °F to 104 °F)

Storage temperature: –20 °C to +60 °C (–4 °F to +140 °F)

Dimensions:

114.5 × 82.8 × 91.8 mm (4 5/8 × 3 3/8 × 3 5/8 inches) (W/H/D, excluding protrusions)

Mass (including NP-FH50 battery pack and

“Memory Stick Duo” media):

Approx. 504 g (11b 1.8 oz)

Microphone: Stereo

Speaker: Monaural

Exif Print: Compatible

PRINT Image Matching III: Compatible

PictBridge: Compatible

BC-VH1 battery charger

Power requirements: AC 100 V to 240 V,
50 Hz/60 Hz, 4 W

Output voltage: DC 8.4 V, 0.28 A

Operating temperature: 0 °C to 40 °C (32 °F to
104 °F)

Storage temperature: -20 °C to +60 °C (-4 °F to
+140 °F)

Dimensions: Approx. 60 × 25 × 95 mm
(2 3/8 × 1 × 3 3/4 inches) (W/H/D)

Mass: Approx. 75 g (2.6 oz)

Rechargeable battery pack NP-FH50

Used battery: Lithium-ion battery

Maximum voltage: DC 8.4 V

Nominal voltage: DC 6.8 V

Maximum charge current: 1.75 A

Maximum charge voltage: DC 8.4 V

Capacity:

typical: 6.1 Wh (900 mAh)

minimum: 5.9 Wh (870 mAh)

Design and specifications are subject to
change without notice.

Trademarks

- The following marks are trademarks of Sony Corporation.
Cyber-shot, “Cyber-shot,” “Memory Stick,” , “Memory Stick PRO,” **MEMORY STICK PRO**, “Memory Stick Duo,” **MEMORY STICK DUO**, “Memory Stick PRO Duo,” **MEMORY STICK PRO DUO**, “Memory Stick PRO-HG Duo,” **MEMORY STICK PRO-HG DUO**, “Memory Stick Micro,” “MagicGate,” **MAGICGATE**, “BRAVIA,” “PhotoTV HD,” “Info LITHIUM”
- HDMI, the HDMI logo and High-Definition Multimedia Interface are trademarks or registered trademarks of HDMI Licensing LLC.
- Microsoft, Windows, DirectX and Windows Vista are either registered trademarks or trademarks of Microsoft Corporation in the United States and/or other countries.
- Macintosh and Mac OS are trademarks or registered trademarks of Apple Inc.
- Intel, MMX, and Pentium are trademarks or registered trademarks of Intel Corporation.
- Adobe and Reader are either trademarks or registered trademarks of Adobe Systems Incorporated in the United States and/or other countries.
- In addition, system and product names used in this manual are, in general, trademarks or registered trademarks of their respective developers or manufacturers. However, the TM or ® marks are not used in all cases in this manual.



Others

75^{GB}

Additional information on this product and answers to frequently asked questions can be found at our Customer Support Website.

<http://www.sony.net/>



Printed on 70% or more recycled paper using VOC (Volatile Organic Compound)-free vegetable oil based ink.

Printed in Japan



4 132058 110