



## Nailer/Stapler Operation Manual

<b>Specifications</b>					
<b>MODEL NO.</b>	<b>NF2502X4</b>	<b>SNC1002X4</b>	<b>NB2002X4</b>	<b>NB1252X4</b>	<b>NBSNC2X4</b>
<b>Max. P.S.I.</b>	120	120	120	120	120
<b>Operating Pressure Range</b>	70-120	70-120	70-120	70-120	57-110
<b>Air Inlet</b>	1/4" NPT	1/4" NPT	1/4" NPT	1/4" NPT	1/4" NPT
<b>Weight</b>	4.66	2.3	2.6	2.55	3.3
<b>Height</b>	10.25	7.5	8.1	7.75	9.68
<b>Length</b>	11.75	11.3	9	9.75	9.72
<b>Width</b>	3	2.25	2	2.25	2.44
<b>Type of Fastener</b>	Finish Nail 16 Gauge	Narrow Crown Staple 18 Gauge	Brad Nail 18 Gauge	Brad Nail 18 Gauge	Brad Nail 18 Gauge/ Narrow Crown Staple 18 Gauge 1/2" - 1 1/2"
<b>Fastener Lengths</b>	See page 17	See page 18	See Page 19	See page 20	See page 21
<b>Fastener Capacity</b>	110 pcs.	150 pcs.	110	110 pcs.	100 pcs.

**This manual contains information that is important for you to know and understand. This information relates to protecting YOUR SAFETY and PREVENTING EQUIPMENT PROBLEMS. PLEASE READ THIS MANUAL.**

# TABLE OF CONTENTS

	<i>Page</i>
Tool Specifications .....	Front Cover
Table of Contents .....	2
Limited Warranty .....	3
Safety Guidelines & Warning Chart .....	4
Lubrication and Maintenance .....	7
Recommended Hook-up .....	9
Contact Trip Safety Mechanism .....	9
A. Operating A Contact Trip Tool	
B. Checking The Operation Of Contact Trip Safety Mechanism	
Loading The Tool .....	10
Operating the Tool .....	12
Clearing A Jam From The Tool .....	13
Trouble Shooting Guide .....	15
NF2502X4 .....	17
SNC1002X4 .....	18
NB2002X4 .....	19
NB1252X4 .....	20
NBSNC2X4 .....	21
Repair Kits Available .....	22
Toll-Free 800 Number .....	Back Cover

## **LIMITED WARRANTY ONE YEAR FROM DATE OF PURCHASE**

*All merchandise manufactured by DeVilbiss Air Power Company/ExCell Manufacturing is warranted to be free of defects in workmanship and material which occur during the first year from the date of purchase by the original purchaser (initial user). Products covered under this warranty include: air compressors, \*air tools, accessories, service parts, pressure washers, and generators used in consumer applications (i.e., personal residential household usage only).*

*Air compressors, \*air tools, accessories, service parts, pressure washers, and generators used in commercial applications (income producing) are covered by a 90 day warranty.*

*DeVilbiss Air Power/ExCell Manufacturing will repair or replace, at DeVilbiss/ExCell's option, products or components which have failed within the warranty period. Repair or replacement, and service calls on 60 and 80 gallon air compressors, will be handled by Authorized Warranty Service Centers and will be scheduled and serviced according to the normal work flow and business hours at the service center location, and depending on the availability of replacement parts.*

*All decisions of DeVilbiss Air Power Company/ExCell Manufacturing with regard to this policy shall be final.*

*This warranty gives you specific legal rights, and you may also have other rights which vary from state to state.*

### **RESPONSIBILITY OF ORIGINAL PURCHASER (Initial User):**



- Retain original cash register sales receipt as proof of purchase for warranty work.
- Use reasonable care in the operation and maintenance of the product as described in the Owners Manual(s).
- Deliver or ship the product to the nearest DeVilbiss Air Power/ExCell Manufacturing Authorized Warranty Service Center. Freight costs, if any, must be paid by the purchaser.
- Air compressors with 60 and 80 gallon tanks only will be inspected at the site of installation. Contact the nearest Authorized Warranty Service Center, that provides on-site service calls, for service call arrangement.
- If the purchaser does not receive satisfactory results from the Authorized Warranty Service Center, the purchaser should contact DeVilbiss Air Power Company/ExCell Manufacturing.

### **THIS WARRANTY DOES NOT COVER:**

- Merchandise sold as reconditioned, floor models and/or display models. Any damaged or incomplete equipment sold "as is".
- Merchandise used as "rental" equipment.
- Merchandise that has become inoperative because of ordinary wear, misuse, freeze damage, use of improper chemicals, negligence, accident, improper and/or unauthorized repair or alterations including failure to operate the product in accordance with the instructions provided in the Owners Manual (s) supplied with the product. \*Air Tools: O-Rings and driver blades are considered ordinary wear parts, therefore, they are warranted for a period of 45 days from the date of purchase.
- An air compressor that pumps air more than 50% during a one hour period is considered misuse because the air compressor is undersized for the required air demand. Maximum compressor pumping time per hour is 30 minutes.
- Merchandise sold by DeVilbiss Air Power/ExCell Manufacturing which has been manufactured by and identified as the product of another company. The product manufacturer's warranty will apply.
- Repair and transportation costs of merchandise determined not to be defective.
- Cost associated with assembly, required oil, adjustments or other installation and start-up cost.
- ANY INCIDENTAL, INDIRECT OR CONSEQUENTIAL LOSS, DAMAGE, OR EXPENSE THAT MAY RESULT FROM ANY DEFECT, FAILURE OR MALFUNCTION OF THE PRODUCT.** Some states do not allow the exclusion or limitation of incidental or consequential damages, so the above limitation or exclusion may not apply to you.
- IMPLIED WARRANTIES, INCLUDING THOSE OF MERCHANTABILITY AND FITNESS FOR A PARTICULAR PURPOSE, ARE LIMITED TO ONE YEAR FROM THE DATE OF ORIGINAL PURCHASE.** Some states do not allow limitations on how long an implied warranty lasts, so the above limitations may not apply to you.



## SAFETY GUIDELINES - DEFINITIONS

<p>This manual contains information that is important for you to know and understand. This information relates to protecting <b>YOUR SAFETY</b> and <b>PREVENTING EQUIPMENT PROBLEMS</b>. To help you recognize this information, we use symbols to the right. Please read the manual and pay attention to these sections.</p>		<p>Information for preventing damage to equipment.</p>
	<p>URGENT SAFETY INFORMATION - A HAZARD THAT WILL CAUSE SERIOUS INJURY OR LOSS OF LIFE.</p>	
		
	<p>IMPORTANT SAFETY INFORMATION - A HAZARD THAT MIGHT CAUSE SERIOUS INJURY OR LOSS OF LIFE.</p>	<p>Information that you should pay special attention to.</p>

## IMPORTANT SAFETY INSTRUCTIONS

• **SAVE THESE INSTRUCTIONS** •

### ⚠ WARNING





IMPROPER OPERATION OR MAINTENANCE OF THIS PRODUCT COULD RESULT IN SERIOUS INJURY AND PROPERTY DAMAGE. READ AND UNDERSTAND ALL WARNINGS AND OPERATING INSTRUCTIONS BEFORE USING THIS EQUIPMENT.

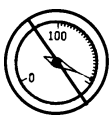

### ⚠ DANGER

**Risk of explosion.**

HAZARD TO LOOK FOR	WHAT COULD HAPPEN	HOW TO PREVENT IT
<p><i>Compressed Gas</i></p> 	<p>Oxygen will react with oil in tool causing an explosion. Flammable gases will ignite from sparking and cause the tool to explode, resulting in serious injury or death.</p>	<p>Do not use any type of flammable gases or oxygen as a power source for the tool.</p> <p>Use only filtered, lubricated, regulated compressed air .</p>
<p><i>Excessive Operating Pressure</i></p> 	<p><b>THE TOOL COULD EXPLODE</b> resulting in serious injury or death.</p>	<p>Operate tool with clean dry air, regulated to no more than the maximum P.S.I. See specification label on tool for the maximum P.S.I.</p>
<p><i>Unsuitable Cleaning Solvents</i></p> 	<p>Flammable vapors in the tool will ignite by a spark and could cause the tool to explode!</p>	<p>Never use gasoline or other flammable liquids to clean the tool.</p>



**⚠ WARNING**

**Risk of head injury.**







HAZARD TO LOOK FOR	WHAT COULD HAPPEN	HOW TO PREVENT IT
<i>Injury to eyes, head and hearing</i>	Metal fragments, fasteners, or other material could be projected against head or into eyes resulting in serious injury or property damage. Continued exposure to an operating tool can result in permanent hearing damage.	Always wear ANSI approved Z87 safety glasses, Z89.1 head protection and S3.19 hearing protection.



**⚠ WARNING**

**Risk of puncture injury.**





HAZARD TO LOOK FOR	WHAT COULD HAPPEN	HOW TO PREVENT IT
<p><i>Injury to eyes, head and hearing</i></p>  	<p>A fastener could accidentally be driven if the contact trip safety mechanism is not working resulting in serious injury or property damage.</p> <p>If the contact trip bumps something or someone while holding the tool with the trigger depressed, serious injury or property damage could occur.</p> <p>Improper handling can result in damage to the contact trip safety mechanism resulting in unsafe operation.</p>	<p>Do not remove, modify or bypass contact safety device.</p> <p>Do not use the tool if any shields or guards are removed or altered.</p> <p>Always check contact trip safety mechanism of the tool before each use.</p> <p>Never carry the tool by the hose or pull the hose to move the tool or a compressor. Keep hoses away from heat, oil and sharp edges. Replace any damaged, weak or worn hoses.</p>
 	<p>Accidental discharge of a fastener can occur, resulting in serious injury or property damage.</p>	<p>Hold tool by the handle and keep trigger and contact trip safety mechanism from contacting objects or parts of the body when connecting or disconnecting air supply.</p> <p>Disconnect air hose before loading fasteners, removing a jammed fasteners.</p>



**⚠ WARNING**

**Risk from flying objects.**



HAZARD TO LOOK FOR	WHAT COULD HAPPEN	HOW TO PREVENT IT
<p><i>Injury to self or others in the work area.</i></p>  	<p>Fasteners could ricochet or be propelled causing serious injury or property damage.</p> <p>When working along edges or next to voids in work surface, the contact trip safety mechanism could be depressed and allow the tool to discharge a fastener into the air or through thin work materials resulting in serious injury or property damage.</p>	<p>Pay attention to others in the work area to assure that they are protected from possible accidental discharge of fastener, or projected fragments of work material, fasteners, etc.</p> <p>Provide ANSI approved Z87 safety glasses, Z89.1 head protection, and S3.19 hearing protection to self and others in the work area.</p> <p>Never point discharge of tool at self or others.</p> <p>Do not pull trigger unless tool contact safety device is against work surface.</p> <p>Never attempt to drive fasteners into hard surfaces such as steel, concrete, or tile.</p> <p>Take care to avoid driving a fastener on top of another fastener.</p> <p>Before operating tool, be certain that work surfaces are strong enough and thick enough to contain entire fastener.</p> <p>Position tool carefully so that fasteners will be delivered to the proper location.</p>

## LUBRICATION AND MAINTENANCE

**⚠ CAUTION**



Do not store the tool in cold weather. Frost or ice can form on the operating valves or mechanisms and the tool may not operate correctly.

**⚠ CAUTION**



In cold weather operation (near or below freezing), DO NOT USE a permanent antifreeze such as ethylene glycol for a cold weather lubricant. This type of antifreeze will damage o-rings and seals of the tool.

**NOTE**

**Proper lubrication is the owner's responsibility.** Failure to lubricate the tool properly will dramatically shorten the life of the tool and void your warranty.

**⚠ CAUTION**

**Your tool requires lubrication before you use it for the first time and before and after each additional use.** If an Oiler is used, manual lubrication through the air inlet is not required on a daily basis. Lubrication prevents wear and prevents rust from forming.

1. Disconnect the air supply from the tool before manually lubricating.

2. Turn the tool so the air inlet is facing up and put **one drop** of DeVilbiss AC230 Air Tool Oil, high speed spindle oil, such as Unocal RX22, or 3-in-1 oil into the air inlet. DO NOT USE detergent oil or additives. Operate the tool briefly after adding oil. (See Figure 1)

**DO NOT OVER LUBRICATE AIR TOOL.**

3. Wipe off excessive oil at the exhaust.

**NOTE**

Many air tool users find it convenient to use an **Oiler** to help provide oil circulation through tool. An **Oiler** also increases the efficiency and useful life of the tool. An oiler is recommended for tools that receive heavy or constant use. Check oil level in the oiler daily. (See Figure 2)

Many air tool users find it convenient to use a **Filter** to remove liquid and solid impurities which can rust or "gum up" internal parts of the tool. A **Filter** also increases the efficiency and useful life of the tool. Drain water from the filter periodically. (See Figure 3)

**Figure 1**

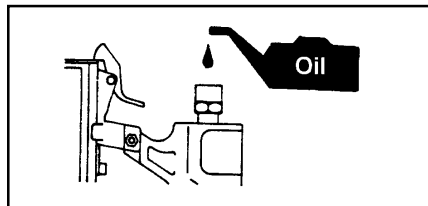

**Figure 2**

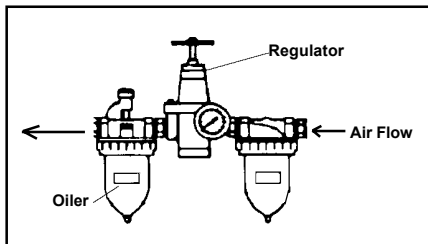

**Figure 3**

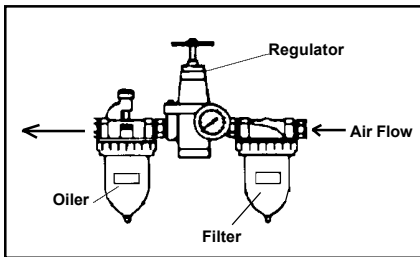

**NOTE**  
Excessive oil will damage o-rings and seal of tool. If in-line oiler is used, manual lubrication through the air inlet is not required on a daily basis.

**⚠ DANGER**

Do not use any type of flammable gases or oxygen as a power source for the tool. Use filtered, lubricated, regulated compressed air only. Use of compressed gas instead of compressed air may cause the tool to explode and cause death or serious personal injury.

**⚠ WARNING**

Do not use a check valve or any other fittings which will allow air to remain in the tool. Serious personal injury or property damage could occur.

**⚠ WARNING**

Use a **Pressure Regulator** on your compressor with an operating pressure of 0-125 PSI. A **Pressure Regulator** is required to control the operating pressure of your tool. Refer to the label on your nailer/stapler for the maximum P.S.I.

Always connect the Female Quick Coupler to the air hose. **Never** connect the Female Quick Coupler to the tool.

**⚠ WARNING**

Never carry the tool by the hose or pull the hose to move the tool or a compressor. Keep hoses away from heat, oil, and sharp edges. Replace any damaged, weak or worn hoses.

The air compressor must be able to maintain a minimum of 65 PSI when the tool is being used. An **inadequate** air supply can cause a loss of power or inconsistent operation.

**NOTE**

For better performance, install a **3/8" Quick Connector (1/4" NPT threads)** with an inside diameter of .315 (8 mm) on your Tool and a **3/8" Quick Coupler on the air hose**. A minimum of 3/8" I.D. air hose with a rated working pressure of 150 PSI or above should be used.



## RECOMMENDED HOOK-UP

The following illustration shows the proper hook-up which will help prolong the life of the Tool.

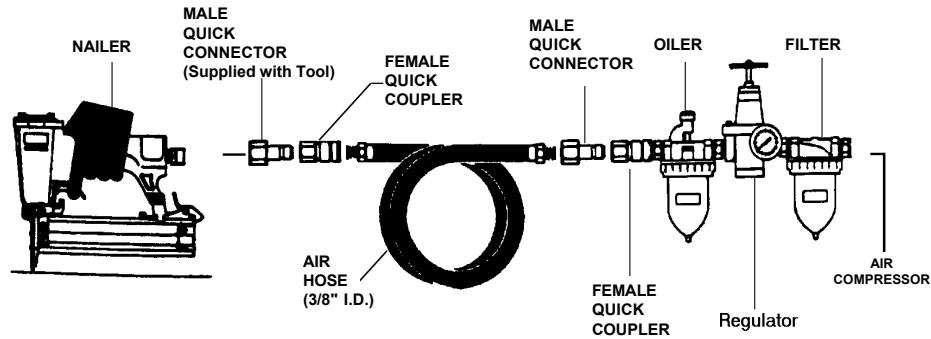

## CONTACT TRIP SAFETY MECHANISM

### 2X4 CONTRACTOR SERIES

#### **⚠ DANGER**



Never keep the trigger pulled on contact trip tools when carrying or holding the tool. Death or a serious puncture wound could occur if the contact trip bumps something or someone.

#### **⚠ WARNING**



Keep your hands and body away from the fastener discharge area of the tool. Serious personal injury or property damage could occur.

#### **⚠ CAUTION**

Do not hold the tool against the work surface with extra force. Allow the tool to drive the fastener.

#### **⚠ WARNING**

Do not use the contact trip mechanism as a means of discharging a fastener because:

1. It could result in personal injury
2. It could result in an accidental release of a fastener.
3. It may cause damage to the mechanism.
4. It could result in improper placement of fastener in work piece.

### CONTACT TRIP SAFETY MECHANISM

Your Nailer/Stapler is a contact trip operated tool. When the operator depresses the contact trip safety mechanism against the work surface and then pulls the trigger, a fastener will be driven.

### OPERATING A CONTACT TRIP TOOL:

1. Requires finger to be off the trigger and the nose of the Tool to be placed on the work surface.
2. The contact trip safety mechanism is then depressed against the work surface and the trigger pulled to drive a fastener.
3. The trigger is released after each fastener is driven.
4. Move the tool to the next desired fastener location and repeat the procedure above.

### CHECKING THE OPERATION OF CONTACT TRIP SAFETY MECHANISM

**⚠ CAUTION**

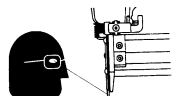

Check the operation of the contact trip safety mechanism often. Do not use the tool if the contact trip safety mechanism is not working correctly.

1. Disconnect the air supply from the tool.
2. Remove all fasteners from the magazine.

**⚠ WARNING**



Make sure not to pull the trigger or depress the contact trip safety mechanism when connecting the tool to an air compressor. Serious personal injury or property damage can occur if the tool cycles.

3. Make sure the trigger and contact trip safety mechanism move up and down without any sticking or binding.
4. Reconnect air supply to the tool.
5. Depress the contact trip safety mechanism against the work surface without pulling the trigger. The tool must not cycle. Do not use the tool if a cycle occurs.
6. Hold the tool clear of the work surface. The contact trip safety mechanism should return to its original down position. Pull the trigger. The tool **must not** cycle. **Do not** use the tool if a cycle occurs.
7. Depress the contact trip safety mechanism against the work surface. Pull the trigger. The tool **must** cycle.

## LOADING THE TOOL

**⚠ WARNING**

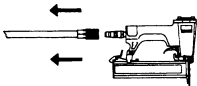

Disconnect tool from air supply before adjusting, clearing jams, servicing, relocating or during non-operation. Failure to do so could result in serious injury or property damage.

**⚠ WARNING**



Never place your hand or any part of your body in the fastener discharge area of the tool when air supply is connected to the tool. Serious personal injury may occur.

**NOTE**

Use DeVilbiss Air Power fasteners or equivalent for proper performance of tool. See page 17-20 for fastener information.

**WARNING**



Handle the tool carefully. Respect the tool as a working implement and always assume the tool contains fasteners:

- a. Never use the tool as a toy and engage in horseplay.
- b. Never aim or point the tool at anyone. The tool may contain fasteners.
- c. Always keep people and animals at a safe distance from the work area in case of accidental discharge of fasteners.
- d. Never pull the trigger unless the nose of the tool is **against** the work surface.
- e. Do not pull the trigger or depress the contact trip when loading the tool.

**Loading the Tool**

1. Disconnect air hose.
2. Pull feeder back into "locked" position.



3. Insert a stick of fasteners into the magazine. Make sure the pointed ends of the fasteners are loaded with the points downward. Also make sure fasteners are not dirty or damaged. Use DeVilbiss fasteners or equivalent for proper fastener performance.

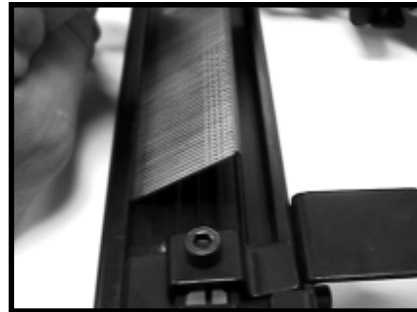

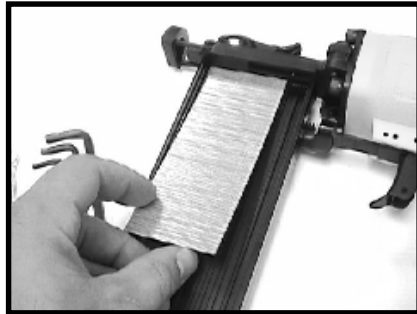
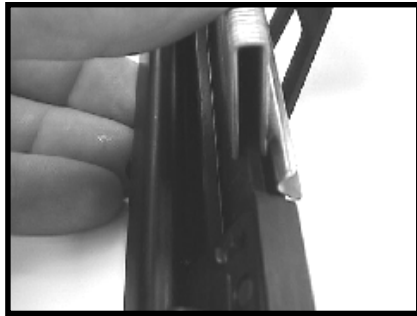

4. Push release button (if equipped) and slide feeder shoe forward.

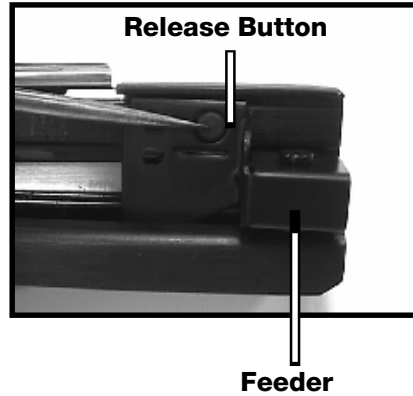

## OPERATING THE TOOL

**READ THIS MANUAL AND UNDERSTAND ALL SAFETY WARNINGS AND INSTRUCTIONS BEFORE OPERATING TOOL.**

### ⚠ WARNING



Protect your eyes and ears. Wear Z87 safety glasses with side shields. Wear hearing protection. Employers and users are responsible for ensuring the user or anyone near the tool uses the prescribed safety equipment.

1. Add **one drop** of DeVilbiss AC230 Air Tool Oil, high speed spindle oil, such as Unocal RX22, or 3-in1 oil into the air inlet.
2. Connect the Tool to the air supply.
3. Regulate the air pressure to obtain a minimum of 75 PSI at the tool.
4. Set air pressure regulator to 75 PSI and test for proper fastener penetration by driving fasteners into a sample piece of

### ⚠ WARNING

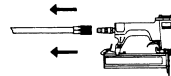

Disconnect tool from air compressor before adjusting, clearing jams, servicing, relocating and during non-operation. Failure to do so could result in serious injury or property damage.

### NOTE

Check and replace any damaged or worn components on the tool. The safety warning labels on the tool must also be replaced if they are not legible.

wood. If the fasteners do not achieve the desired penetration, adjust the air pressure to a lower or higher setting until the desired penetration is achieved. Do not exceed the maximum operating PSI at the tool.

**NOTE: When loaded with Brad Nails, the NBSNC2x4 will leave a 1/4 inch indentation. Tilting the tool to the left 10° will eliminate the indentation.**

## CLEARING A JAM FROM THE TOOL

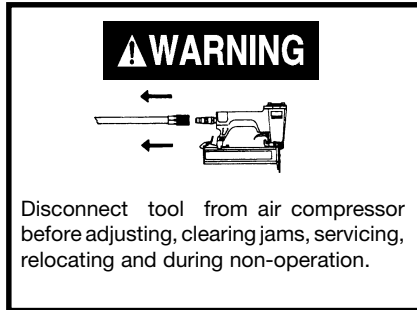

### FASTENER JAMMED IN FASTENER DISCHARGE AREA:

1. Disconnect tool from air hose.
2. **NF2502X4, NB1252X4, NB2002X4, NBSNC2X4**  
Release the magazine latch to open the magazine.



### SNC1002x4

Pull feeder shoe back into "locked" position.

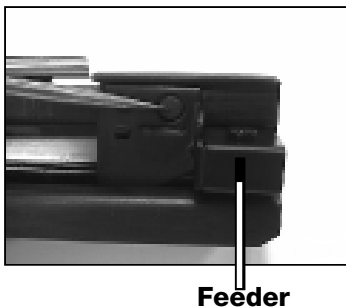

3. Remove fasteners from magazine.
4. **NF2502X4, SNC1002X4, NB2002X4, and NB1252X4**

Lift nose cover latch to unlatch and remove driver guide cover.

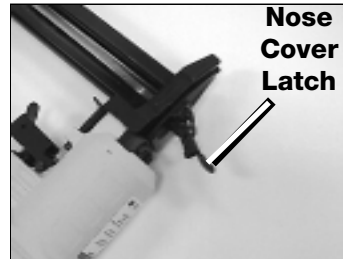

### NBSNC2x4

Loosen the screws on the driver guide cover and then remove the driver guide cover.



5. Using pliers remove fasteners.



6. **NF2502X4, NB1252X4, NB2002X4, and SNC1002X4**

Replace nose cover and latch into place.

### NBSNC2X4

Replace nose cover.

7. Reload fasteners into magazine. Refer to Loading the Tool section in this manual.

**FASTENER JAM INSIDE MAGAZINE:**

1. Disconnect tool from air hose.
2. **NF2502X4, NB1252X4, NB2002X4, NBSNC2X4**  
Release the magazine latch to open the magazine.



**SNC1002x4**

Pull feeder shoe back into "locked" position.

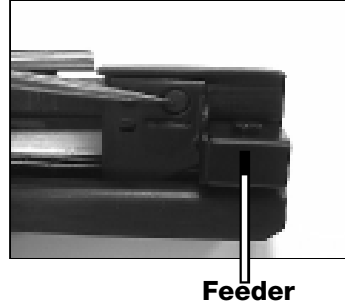

3. Remove jammed fasteners.
4. Reload fasteners into magazine. Refer to Loading the Tool section in this manual.

# TROUBLESHOOTING GUIDE

## ⚠ WARNING

Stop using the Tool immediately if any of the following occur.

Serious personal injury could occur.

Warranty repairs or replacements **must** be performed by a DeVilbiss Air Power  
**Authorized Service Center Only.**

PROBLEM	CAUSE	SOLUTION
<i>Air leaking at trigger valve area.</i>	Seals in trigger valve housing are damaged.	Seals must be replaced & operation of Contact trip must be checked. On the NBSNC2x4 contact <b>*AWSC</b> for correct part. All other nailers purchase <b>Trigger Repair Kit.</b>
<i>Air leaking through the exhaust deflector.</i>	Broken /worn head valve spring. Broken /worn head valve seals.	Spring needs to be replaced. On the NBSNC2x4 contact <b>*AWSC</b> for correct part. All other nailers purchase <b>Top Repair Kit.</b>  Seals must be replaced. Purchase <b>Top Repair Kit on all nailers.</b>
<i>Tool fails to drive fastener.</i>	Worn or damaged driver guide.  Damaged feed pawl.  Worn feed pawl spring.  Damaged feed pawl pin.  Inadequate air flow or pressure to Tool.  Worn seal on piston or lack of lubrication.  Damaged seal on trigger valve.  Air leaks.  Cap seal leaking.	Driver guide needs to be replaced. Purchase <b>Driver Blade Kit</b>  Replace feed pawl. Contact a <b>*AWSC</b>  Replace feed pawl spring. Contact a <b>*AWSC</b>  Replace feed pawl pin. Contact a <b>*AWSC</b>  Verify air flow or pressure to tool.  Replace or lubricate seal. Purchase <b>Bottom Repair Kit</b>  Replace seal. Purchase <b>Trigger Repair Kit</b>  Screws and fittings need to be tightened.  Replace seal. Purchase <b>Top Repair Kit</b>
<i>Tool runs slow or has loss of power.</i>	Tool not lubricated sufficiently.  Inadequate air flow or pressure to tool.  Worn seal on piston.  Broken spring in cylinder cap.  Worn head valve seals.	Tools needs to be lubricated.  Verify air flow or pressure to tool.  Replace seal. Purchase <b>Bottom Repair Kit</b>  Spring needs to be replaced. On the NBSNC2x4 contact <b>*AWSC</b> for correct part. All other nailers purchase <b>Top Repair Kit.</b>  Replace seals. Contact a <b>*AWSC</b>

## TROUBLESHOOTING GUIDE (cont'd)

PROBLEM	CAUSE	SOLUTION
<i>Fasteners are jammed in tool.</i>	Worn/damaged feed pawl.	Replace feed pawl. Contact an <b>*AWSC</b>
	Worn/damaged feed pawl spring.	Replace feed pawl spring.
	Fasteners are not correct size.	Fasteners recommended for tool must be used.
	Fasteners are bent.	Replace with undamaged fasteners.
	Nail height setting incorrect.	Set platform to correct height.
<i>Nailer/Stapler misfires or sinks two nails/staples at the same time.</i>	Air pressure regulated too high.	Adjust air pressure to the correct PSI for that particular model nailer/stapler.
	Trigger action faulty.	Repair trigger action. Purchase a <b>Trigger Repair Kit</b>
<i>Air leak near top of tool.</i>	Loose exhaust cover screws.	Tighten screws.
	O-rings failed on head valve.	Install head valve piston set. Contact an <b>*AWSC</b>
<i>Sluggish operation.</i>	O-rings blown on head valve.	Install head valve piston set. Contact an <b>*AWSC</b>
	Loose driver guide screws.	Tighten screws.
<i>Air leak near bottom of tool.</i>	Bumper or piston o-rings worn.	Replace bumper or piston assembly. Purchase a <b>Bottom Repair Kit</b>
<i>Tool does nothing.</i>	Air supply inadequate.	Check PSI and CFM.
	O-rings failed on head valve piston set.	Install head valve piston set. Contact an <b>*AWSC</b>
<i>Poor driver blade return.</i>	Dirty cylinder.	Disassemble and clean cylinder.
	Worn Bumper.	Replace bumper. Purchase <b>Bottom Repair Kit</b>
	O-rings worn in piston assembly.	Replace piston assembly. On the NBSNC2x4 contact an <b>*AWSC</b> for correct part. All other nailers purchase <b>Bottom Repair Kit</b> .
<i>Weak Drive.</i>	Inadequate air supply.	Check PSI and CFM.
	Worn piston assembly.	Replace piston assembly. On the NBSNC2x4 contact <b>*AWSC</b> for correct part. All other nailers purchase <b>Bottom Repair Kit</b> .
<i>NBSNC2X4 leaving a 1/4" indentation.</i>	Driver blade width is 1/4" making it possible to use staples and brad nails in the same tool	Tilting the tool to the left 10° will eliminate the indentation.

**\*AWSC – Authorized Warranty Service Center: see back page for details**



# NF2502X4

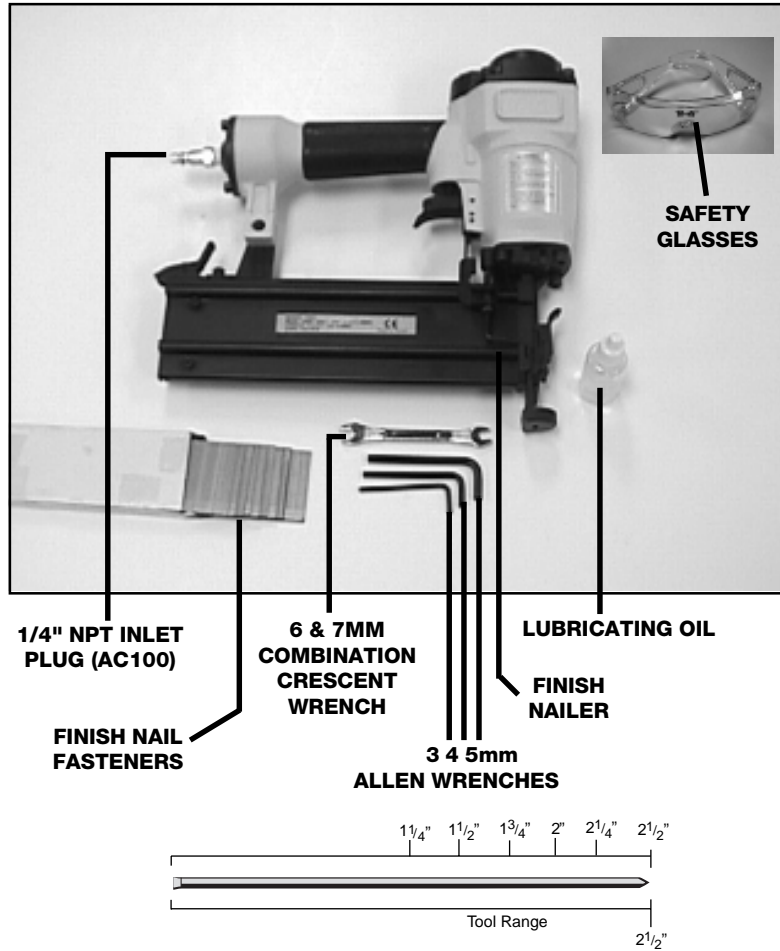

Tool	2X4 Part Number	Description	Qty per Box	Steel Driver Series Comparable Part
NF2502X4	NFF12525	1-1/4" Finish	2500	7T32
	NFF15025	1-1/2" Finish	2500	7T38
	NFF17525	1-3/4" Finish	2500	7T45
	NFF20025	2" Finish	2500	7T50
	NFF22525	2-1/4" Finish	2500	
	NFF25025	2-1/2" Finish	2500	

## SNC1002X4

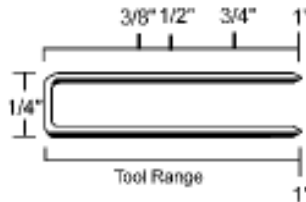
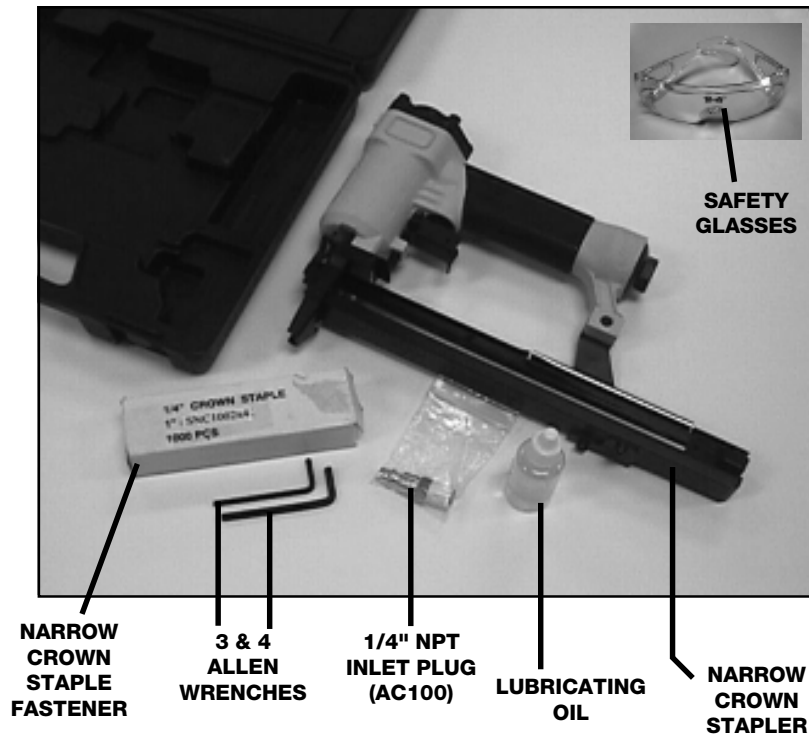

Tool	2X4 Part Number	Description	Qty per Box	Steel Driver Series Comparable Part
SNC1002X4	SNCF06350	5/8" Staple	5000	2L16
	SNCF07550	3/4" Staple	5000	2L19
	SNCF10050	1" Staple	5000	2L25

# NB2002X4

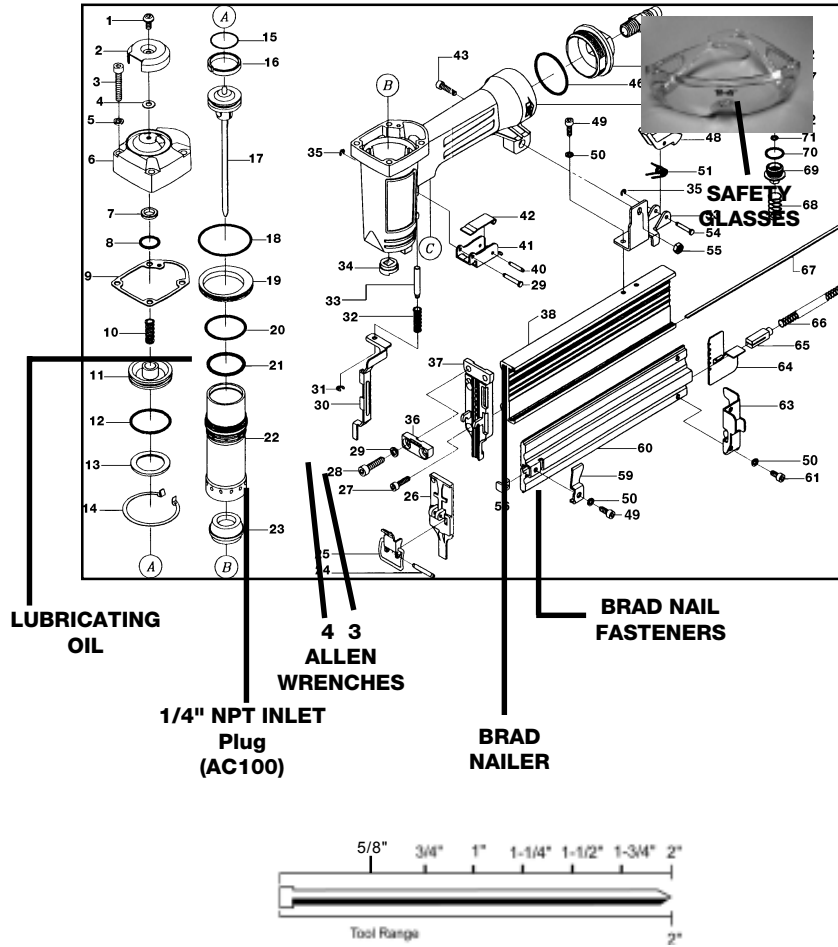

Tool	2X4 Part Number	Description	Qty per Box	Steel Driver Series Comparable Part
NB2002X4	NBF07550	3/4" Brad	5000	4F20
	NBF10050	1" Brad	5000	4F25
	NBF12550	1-1/4" Brad	5000	4F32
	NBF15050	1-1/2" Brad	5000	
	NBF17550	1-3/4" Brad	5000	
	NBF20050	2" Brad	5000	

## NB1252X4

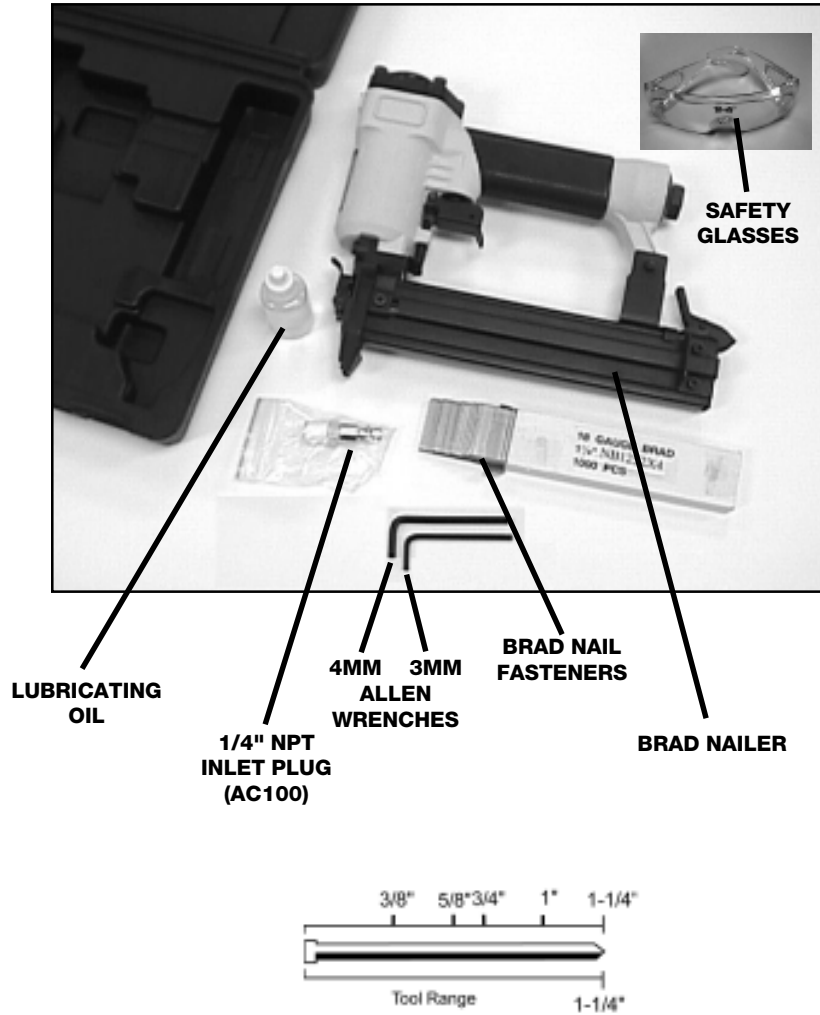

Tool	2X4 Part Number	Description	Qty per Box	Steel Driver Series Comparable Part
NB1252X4	NBF06350	5/8" Brad	5000	4F16
	NBF07550	3/4" Brad	5000	4F20
	NBF10050	1" Brad	5000	4F25
	NBF12550	1-1/4" Brad	5000	4F32

# NBSNC2X4

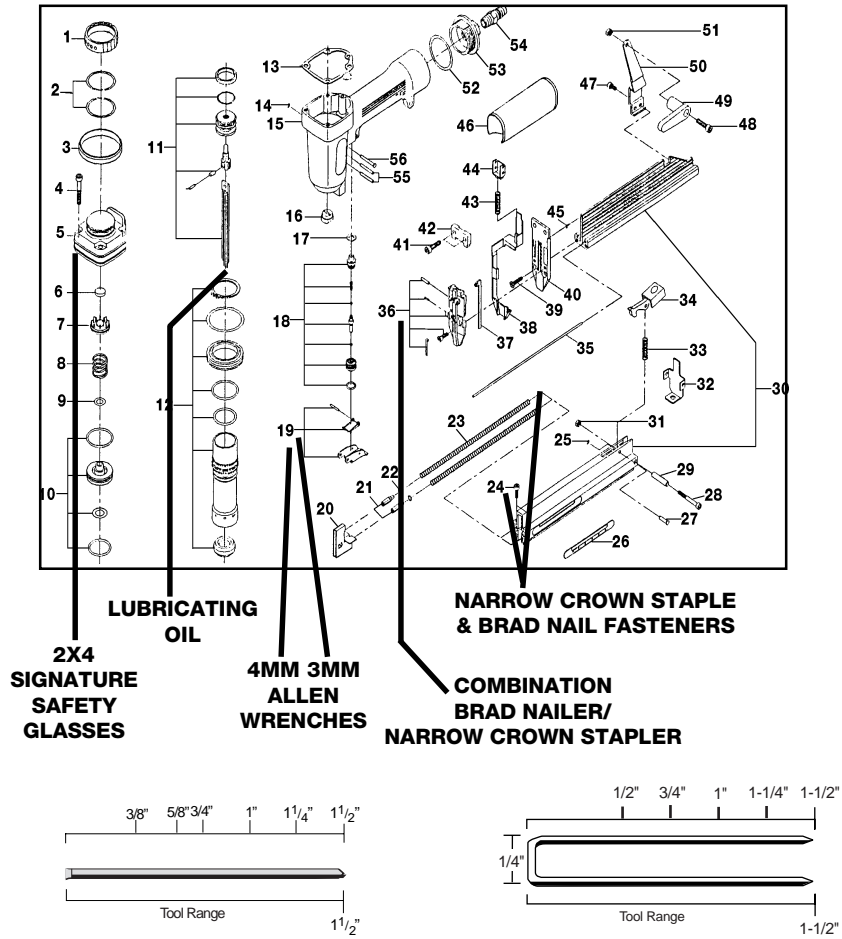

Tool	2X4 Part Number	Description	Qty per Box	Steel Driver Series Comparable Part
NBSNC2X4	SNCF06350	5/8" Staple	5000	2L16
	SNCF07550	3/4" Staple	5000	2L19
	SNCF10050	1" Staple	5000	2L25
	SNCF12550	1-1/4" Staple	5000	
	SNCF15050	1-1/2" Staple	5000	
	NBF06350	5/8" Brad	5000	4F16
	NBF07550	3/4" Brad	5000	4F20
	NBF10050	1" Brad	5000	4F25
	NBF12550	1-1/4" Brad	5000	4F32
	NBF15050	1-1/2" Brad	5000	

## REPAIR KITS AVAILABLE

### NF2502X4

K-0521 Top Repair Kit

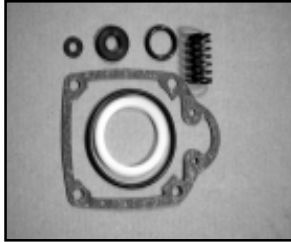

K-1664 Driver Blade Kit

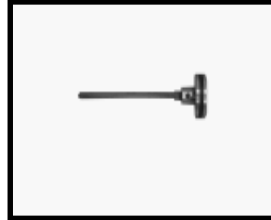

K-0522 Bottom Repair Kit



K-0523 Trigger Repair Kit

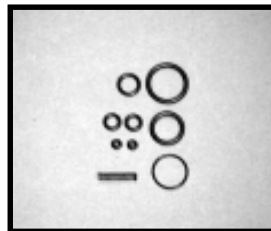

### SNC1002X4 and NB1252X4

K-0525 Top Repair Kit



K-9025 Driver Blade Kit for SNC1002x4

K-1832 Drive Blade Kit for NB1252x4

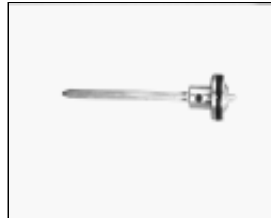

K-0526 Bottom Repair Kit

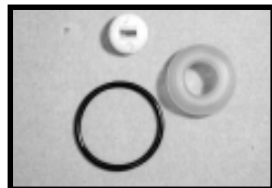

K-0527 Trigger Repair Kit

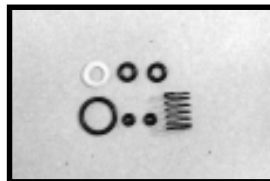

## REPAIR KITS AVAILABLE

### NB2002X4

K-0517 Top Repair Kit



K-1850 Driver Blade Kit



K-0518 Bottom Repair Kit



K-0519 Trigger Repair Kit

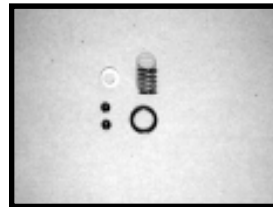

### NBSNC2X4

B340-06 Top Repair Kit

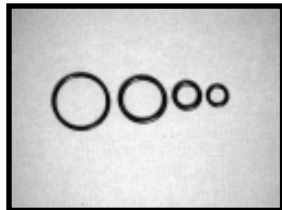

BN2B-10 Driver Blade Kit



B232-23 Bottom Repair Kit



B251-02 Trigger Repair Kit

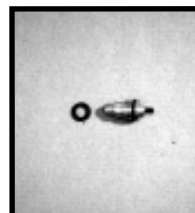



## Nailer/Stapler Operation Manual

Call our **Toll Free Number 1-800-888-2468, Ext 2, then 1**, to obtain the location of the nearest Authorized Service Center for ordering repair parts and for warranty repairs.

When ordering repair parts from your local Authorized Service Center, always give the following information:

- Model number of your product
- Part number and description of the item you wish to purchase

### WARRANTY

This product is covered by the DeVilbiss one year limited warranty. The warranty can be found on page 3 or is available upon request.

*Retain the original sales receipts  
as proof of purchase for warranty  
repair work.*

*Attach sales receipt here.*