

DENON

STEREO CASSETTE TAPE DECK

DRW-585

OPERATING INSTRUCTIONS

MODE D'EMPLOI

INSTRUCCIONES DE OPERACION

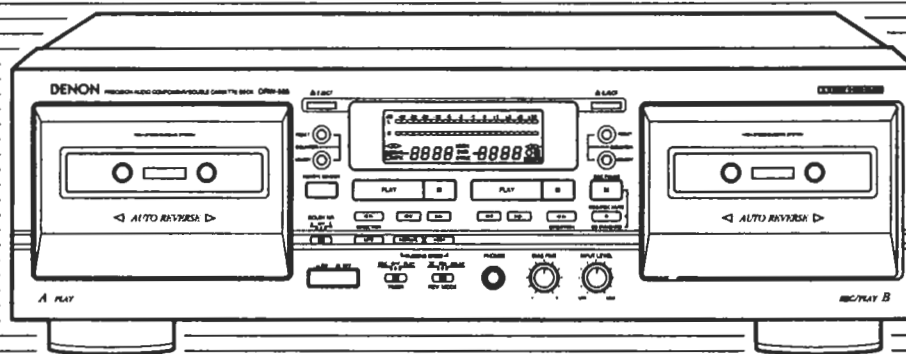

FOR ENGLISH READERS PAGE 5 ~ PAGE 16
POUR LES LECTEURS FRANCAIS PAGE 17 ~ PAGE 28
PARA LECTORES DE ESPAÑOL PAGINA 29 ~ PAGINA 37

IMPORTANT TO SAFETY

WARNING:

TO PREVENT FIRE OR SHOCK HAZARD, DO NOT EXPOSE THIS APPLIANCE TO RAIN OR MOISTURE.

CAUTION:

- Handle the power supply cord carefully**
Do not damage or deform the power supply cord. If it is damaged or deformed, it may cause electric shock or malfunction when used. When removing it from wall outlet, be sure to remove by holding the plug attachment and not by pulling the cord.
- Do not open the top cover**
In order to prevent electric shock, do not open the top cover. If problems occur, contact your DENON DEALER.
- Do not place anything inside**
Do not place metal objects or spill liquid inside the cassette tape deck. Electric shock or malfunction may result.

Please, record and retain the Model name and serial number of your set shown on the rating label.

Model No. DRW-585

Serial No. _____



CAUTION
RISK OF ELECTRIC SHOCK
DO NOT OPEN



CAUTION: TO REDUCE THE RISK OF ELECTRIC SHOCK, DO NOT REMOVE COVER (OR BACK). NO USER SERVICEABLE PARTS INSIDE. REFER SERVICING TO QUALIFIED SERVICE PERSONNEL.



The lightning flash with arrowhead symbol within an equilateral triangle is intended to alert the user of the presence of uninsulated "dangerous voltage" within the product's enclosure that may be of sufficient magnitude to constitute a risk of electric shock to persons.



The exclamation point within an equilateral triangle is intended to alert the user of the presence of important operating and maintenance (servicing) instruction in the literature accompanying the appliance.

• FOR U.S.A. & CANADA MODEL ONLY

CAUTION

TO PREVENT ELECTRIC SHOCK DO NOT USE THIS (POLARIZED) PLUG WITH AN EXTENSION CORD, RECEPTACLE OR OTHER OUTLET UNLESS THE BLADES CAN BE FULLY INSERTED TO PREVENT BLADE EXPOSURE.

• POUR LES MODELES AMERICAINS ET CANADIENS UNIQUEMENT

ATTENTION

POUR PREVENIR LES CHOCS ELECTRIQUES NE PAS UTILISER CETTE FICHE POLARISEE AVEC UN PROLONGATEUR UNE PRISE DE COURANT OU UNE AUTRE SORTIE DE COURANT, SAUF SI LES LAMES PEUVENT ETRE INSEREES A FOND SANS EN LAISSER AUCUNE PARTIE A DECOUVERT.

This device complies with Part 15 of the FCC Rules. Operation is subject to the following two conditions: (1) This device may not cause harmful interference, and (2) this device must accept any interference received, including interference that may cause undesired operation.

This Class B digital apparatus meets all requirements of the Canadian Interference-Causing Equipment Regulations.

Cet appareil numérique de la classe B respecte toutes les exigences du Règlement sur le matériel brouilleur du Canada.

SAFETY INSTRUCTIONS

1. Read Instructions – All the safety and operating instructions should be read before the appliance is operated.
2. Retain Instructions – The safety and operating instructions should be retained for future reference.
3. Heed Warnings – All warnings on the appliance and in the operating instructions should be adhered to.
4. Follow Instructions – All operating and use instructions should be followed.
5. Water and Moisture – The appliance should not be used near water – for example, near a bathtub, washbowl, kitchen sink, laundry tub, in a wet basement, or near a swimming pool, and the like.
6. Carts and Stands – The appliance should be used only with a cart or stand that is recommended by the manufacturer.



- 6A. An appliance and cart combination should be moved with care. Quick stops, excessive force, and uneven surfaces may cause the appliance and cart combination to overturn.
7. Wall or Ceiling Mounting – The appliance should be mounted to a wall or ceiling only as recommended by the manufacturer.
8. Ventilation – The appliance should be situated so that its location or position does not interfere with its proper ventilation. For example, the appliance should not be situated on a bed, sofa, rug, or similar surface that may block the ventilation openings; or, placed in a built-in installation, such as a bookcase or cabinet that may impede the flow of air through the ventilation openings.
9. Heat – The appliance should be situated away from heat sources such as radiators, heat registers, stoves, or other appliances (including amplifiers) that produce heat.
10. Power Sources – The appliance should be connected to a power supply only of the type described in the operating instructions or as marked on the appliance.
11. Grounding or Polarization – Precautions should be taken so that the grounding or polarization means of an appliance is not defeated.

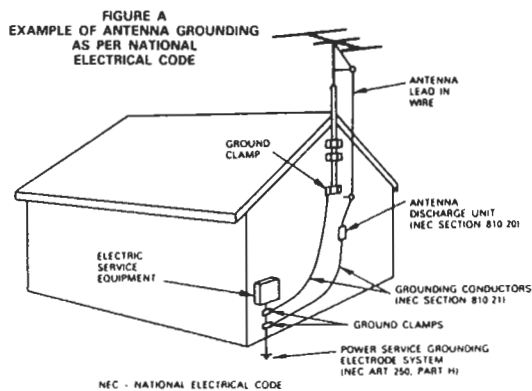

12. Power-Cord Protection – Power-supply cords should be routed so that they are not likely to be walked on or pinched by items placed upon or against them, paying particular attention to cords at plugs, convenience receptacles, and the point where they exit from the appliance.
14. Cleaning – The appliance should be cleaned only as recommended by the manufacturer.
15. Power Lines – An outdoor antenna should be located away from power lines.
16. Outdoor Antenna Grounding – If an outside antenna is connected to the receiver, be sure the antenna system is grounded so as to provide some protection against voltage surges and built-up static charges. Article 810 of the National Electrical Code, ANSI/NFPA 70, provides information with regard to proper grounding of the mast and supporting structure, grounding of the lead-in wire to an antenna-discharge unit, size of grounding conductors, location of antenna-discharge unit, connection to grounding electrodes, and requirements for the grounding electrode. See Figure A.
17. Nonuse Periods – The power cord of the appliance should be unplugged from the outlet when left unused for a long period of time.
18. Object and Liquid Entry – Care should be taken so that objects do not fall and liquids are not spilled into the enclosure through openings.
19. Damage Requiring Service – The appliance should be serviced by qualified service personnel when:
 - A. The power-supply cord or the plug has been damaged; or
 - B. Objects have fallen, or liquid has been spilled into the appliance; or
 - C. The appliance has been exposed to rain; or
 - D. The appliance does not appear to operate normally or exhibits a marked change in performance; or
 - E. The appliance has been dropped, or the enclosure damaged.
20. Servicing – The user should not attempt to service the appliance beyond that described in the operating instructions. All other servicing should be referred to qualified service personnel.

NOTE ON USE / OBSERVATIONS RELATIVES A L'UTILISATION / NOTAS SOBRE EL USO

 <ul style="list-style-type: none"> ● Avoid high temperatures Allow for sufficient heat dispersion when installed on a rack. ● Eviter des températures élevées Tenir compte d'une dispersion de chaleur suffisante lors de l'installation sur une étagère. ● Evite altas temperaturas Permite la suficiente dispersión del calor cuando está instalado en la consola. 	 <ul style="list-style-type: none"> ● Keep the set free from moisture, water, and dust. ● Protéger l'appareil contre l'humidité, l'eau et la poussière. ● Mantenga el equipo libre de humedad, agua y polvo. 	 <ul style="list-style-type: none"> ● Do not let foreign objects in the set. ● Ne pas laisser des objets étrangers dans l'appareil. ● No deje objetos extraños dentro del equipo.
 <ul style="list-style-type: none"> ● Handle the power cord carefully. Hold the plug when unplugging the cord. ● Manipuler le cordon d'alimentation avec précaution. Tenir la prise lors du débranchement du cordon. ● Maneje el cordón de energía con cuidado. Sostenga el enchufe cuando desconecte el cordón de energía. 	 <ul style="list-style-type: none"> ● Unplug the power cord when not using the set for long periods of time. ● Débrancher le cordon d'alimentation lorsque l'appareil n'est pas utilisé pendant de longues périodes. ● Desconecte el cordón de energía cuando no utilice el equipo por mucho tiempo. 	 <ul style="list-style-type: none"> ● Do not let insecticides, benzene, and thinner come in contact with the set. ● Ne pas mettre en contact des insecticides, du benzène et un diluant avec l'appareil. ● No permita el contacto de insecticidas, gasolina y diluyentes con el equipo.
 <ul style="list-style-type: none"> ● Handle the power cord carefully. Hold the plug when unplugging the cord. ● Manipuler le cordon d'alimentation avec précaution. Tenir la prise lors du débranchement du cordon. ● Maneje el cordón de energía con cuidado. Sostenga el enchufe cuando desconecte el cordón de energía. 	<p>*(For sets with ventilation holes)</p> <ul style="list-style-type: none"> ● Do not obstruct the ventilation holes. ● Ne pas obstruer les trous d'aération. ● No obstruya los orificios de ventilación. 	 <ul style="list-style-type: none"> ● Never disassemble or modify the set in any way. ● Ne jamais démonter ou modifier l'appareil d'une manière ou d'une autre. ● Nunca desarme o modifique el equipo de ninguna manera.

Thank you very much for purchasing the DENON component stereo cassette tape deck.
 DENON proudly presents this advanced tape deck to audiophiles and music lovers as a further proof of DENON's non-compromising pursuit of the ultimate in sound quality. The high quality performance and easy operation are certain to provide you with many hours of outstanding listening pleasure.

— TABLE OF CONTENTS —

FEATURES 5
 CONNECTION 5
 NAMES AND FUNCTION OF PARTS 6, 7
 CASSETTE TAPES 7
 AUTOMATIC TAPE SELECTION 8
 PLAYBACK 8
 RELAY PLAY 9
 MUSIC SEARCH SYSTEM 9
 RECORDING 10
 PROPER RECORDING LEVEL 11
 RECORDING BIAS ADJUSTMENT 11
 REC/REC MUTE AND REC PAUSE BUTTON 11
 DIMMER ADJUSTMENT 11
 DUBBING 12
 SYNCHRONIZED RECORDING FUNCTION 12, 13
 TAPE COUNTER AND MEMORY STOP 13
 TIMER RECORDING/PLAYBACK 14
 DOLBY B AND C NOISE REDUCTION SYSTEM 14
 DOLBY HX-PRO HEADROOM EXTENSION SYSTEM 15
 MAINTENANCE 15
 TROUBLESHOOTING 16
 SPECIFICATIONS 16

Please check to make sure the following items are included with the main unit in the carton:

- (1) Operating Instructions 1
- (2) Connection Cords 2
- (3) Mini-Plug Cable 1

FEATURES

- Computer Controlled Mechanism
- Dual Power Supply
- Dolby HX-Pro Headroom Extension System
- Dolby B & C Noise Reduction Systems
- Manual Bias Adjustment Control
- Dual Computing Tape Counter with 4-Digit Readout and Memory Stop
- Music Search System
- FL Peak Level Meters
- Auto Tape Selector
- 2-Speed Dubbing
- Relay Playback
- Synchronized Recording
- Timer Play and Timer Recording
- Optional Remote Controllable
- Tape Lighting

CONNECTION

- Leave your entire system (including this cassette deck) turned off until all connections between the deck and other components have been completed.

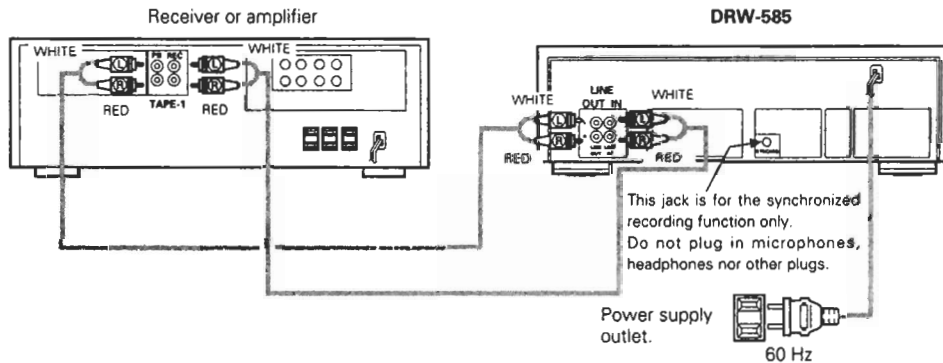

- **Connecting the Deck to an Amplifier**
 - Before connecting the deck to your amplifier, please review your amplifier's instruction manual.
 - Use the white plugs for the left channel and red plugs for the right channel.
- **Tape Dubbing**
 - Many stereo amplifiers and receivers have tape dubbing circuitry so that tape duplication can be performed between two or more tape decks. Review your amplifier's instruction manual for a full explanation of this mode of operation.
- **Connecting Headphones**
 To listen through headphones, plug your headphones into the PHONES jack.

- **Installation Precautions**
 If the deck is placed near an amplifier, TV or tuner, noise (induced hum) or beat interference may result, especially during FM or AM reception. If this occurs, place the deck further away from other components or reorient its position.

Caution
 A mechanical sound is heard the first time the power switch is set to "ON" after the power cord is plugged into an outlet. This is the sound of the cassette mechanism being set to the proper operating state, and is normal.
 (When using an AC outlet on a receiver or amplifier, used an "UNSWITCHED" outlet.)

NAMES AND FUNCTIONS OF PARTS

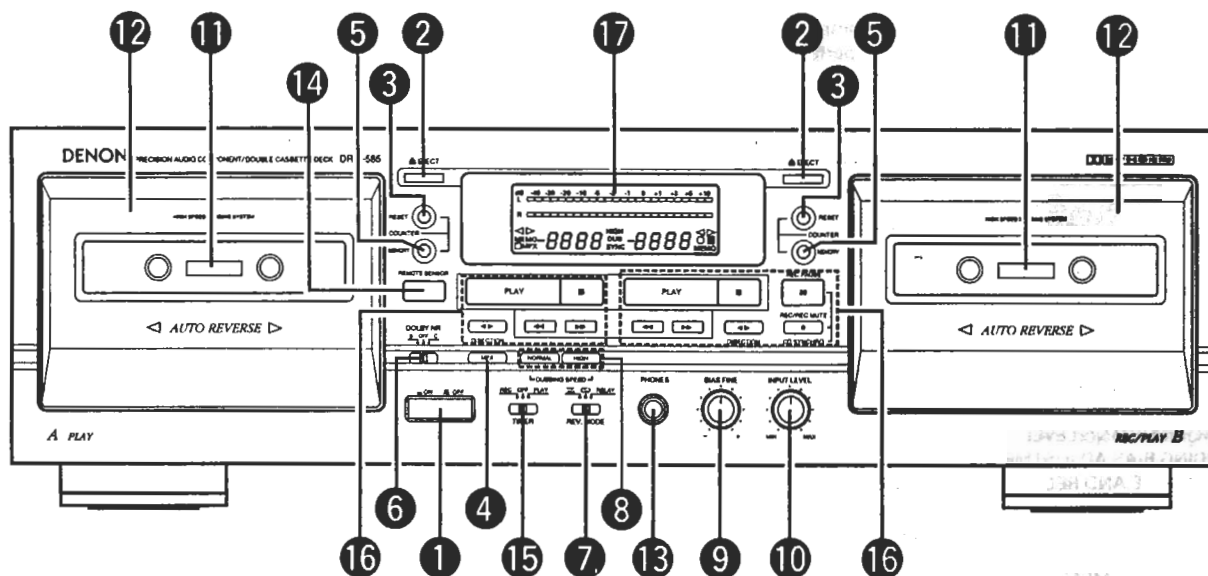

- 1 Power Operation Switch**
 Press once to turn the power to deck on, and once more to turn the power off.
 The deck remains in a stand-by (non-operative) mode for approximately 2 seconds after it is switched on.
- 2 Eject Button (▲)**
 Press this button to open the cassette compartment cover. When the tape is running, press the STOP (■) button first to stop tape transport, then press the Eject button.
- 3 Counter Reset Button (COUNTER RESET)**
 Press this button to reset the tape counter to zero.
- 4 MPX Filter Button (MPX)**
 The MPX FILTER button should be used to prevent interference with the Dolby NR circuit when making Dolby NR encoded recordings of FM stereo programs.
 When making Dolby NR encoded recordings from any program source other than FM stereo, leave this button in the "OFF" position.
- 5 Counter Memory Button (MEMORY)**
 When this button is pressed during forward tape travel (▷), fast rewinding (◀◀) will stop automatically at the tape counter position "0000".
 When this button is pressed during reverse tape travel (◁), fast forwarding (▶▶) will stop automatically at the tape counter position "0000". See page 13.
- 6 Dolby NR Switch (DOLBY NR)**
 To record or playback tapes with Dolby B or C-type noise reduction, set this switch to "B" or "C". Turn it "OFF" when not using the Dolby NR system.
- 7 Reverse Mode Switch (REV. MODE)**
 Select the type of tape transport. The reverse mode can be set to ← (one side), ↻ (continuous playback), RELAY (relay playback).
- 8 Dubbing Speed Buttons (DUBBING SPEED)**
 Pressing the NORMAL button starts regular speed dubbing from deck A to deck B. Press the HIGH button to perform dubbing at double speed. See page 12.
- 9 Bias Fine Control (BIAS FINE)**
 (For Normal, CrO₂ and Metal tape)
 Use this control to fine-adjust the bias. Standard bias is obtained at the center click-stop position. See page 11.
- 10 Input Level Control (INPUT LEVEL)**
 This knob adjusts the recording input level. It affects the level in both channels. See page 10.
- 11 Tape Lighting**
 The tape lighting makes it possible to clearly check the amount of tape remaining.
- 12 Cassette Compartment Cover**
 If the cover is not closed completely, the tape transport buttons will remain inoperative.
- 13 Headphone Jack (PHONES)**
 For private music enjoyment without disturbing others, or for monitoring a recording, a headphone set may be connected to this jack. Use a headphone with an impedance rating of 8 to 1200 Ω/ohms.
- 14 Remote Sensor (REMOTE SENSOR)**
 With DRW-585 the remote control unit is not included.
 Each of "PLAY, FF, REW, STOP, REC PAUSE and REC/REC MUTE" functions can be remote controlled with wireless handset of the receiver (DRA Series receivers). For details refer to the DRA Series operating instructions.
NOTE:
 Note that only the A deck can be operated with remote control units which have no A/B selector button.
- 15 Timer Switch (TIMER)**
 This switch is provided for use with an optional audio timer for unattended recording or morning alarm playback.
 For non-timer operation, this switch should be set in the "OFF" position. See page 14.

Caution: Whenever the power switch is in the OFF state, the apparatus is still connected on AC line voltage. Please be sure to unplug the cord when you leave home for, say, a vacation.

16 Tape Transport Buttons

PLAY	Play Button	Press to playback tape.
■	Stop Button	Press to stop the tape in any mode.
◀◀	Fast Rewind Button	Press for fast rewind.
▶▶	Fast Forward Button	Press for fast forwarding.
● REC/REC MUTE (Deck B only)	Rec/Rec Mute Button	Press the REC/REC MUTE (●) button and PLAY button simultaneously to start recording. If only the REC/REC MUTE (●) button is pressed, the deck enters the Recording Pause mode. Pressing this button in the Recording Pause mode will start Auto Rec Mute, and a 5-second silent space is recorded onto the tape. See page 11.
⏸ REC PAUSE (Deck B only)	Rec Pause Button	Press this button to enter the recording pause mode from the recording or recording mute mode. This button can only be used during recording. See page 11.
◀▶	Direction Button	Changes the tape transport direction from forward "▶" to reverse "◀", and vice versa.

17 Display

Indicators with an encircled number light up when the corresponding button is pressed.

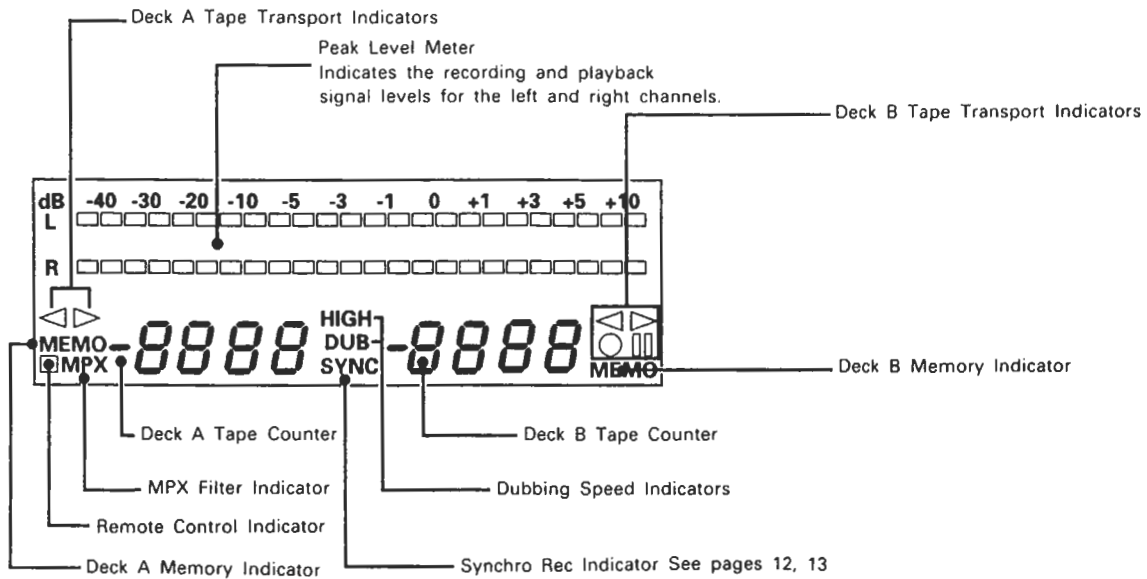

CASSETTE TAPES

■ Handling Precautions

- C-120 Cassettes
C-120 cassette tapes are not recommended as they use a very thin tape base which may become tangled around the capstan or pinch roller.
- Tape Slack
Before putting a tape into the deck, take up any slack with a pencil or your finger tip. This precaution prevents the tape from becoming entangled around the capstan or pinch roller.

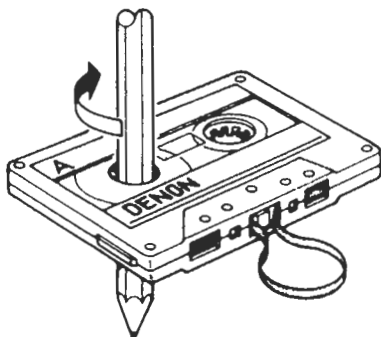

■ Storage Precautions

- Do not store cassette tapes in a place where they will be subject to:
 - Extremely high temperature or excessive moisture
 - Excessive dust
 - Direct sunlight
 - Magnetic fields (near TV sets or speakers)
- To eliminate tape slack, store your cassettes in cassette cases with hub stops

■ Accidental Erasure Prevention

- All cassettes have erasure prevention tabs for each side. To protect valuable recordings from accidental or inadvertent erasure, remove the tab for the appropriate side with a screwdriver or another tool.
- To record on a tape whose erasure prevention tabs have been removed, cover the tab holes with adhesive tape.



Erasure prevention tab for side A

Erasure prevention tab for side B

AUTOMATIC TAPE SELECTION

This Stereo Cassette Deck contains an automatic tape selector which automatically selects the optimum bias and equalization for the tape in use. This is accomplished by detection of the tape type detection holes in the cassette housing.

- If a tape without tape type detection holes is used, the deck will be set for normal tapes.

Detection holes for metal tape

Detection holes for chrome tape

PLAYBACK

- The operations described below apply to deck A and deck B alike.
- Switch on your amplifier or receiver.
- Set the Tape Monitor switch on your amplifier or receiver to the TAPE position.
- The numbers in the illustration below depict the order in which operation steps are carried out.

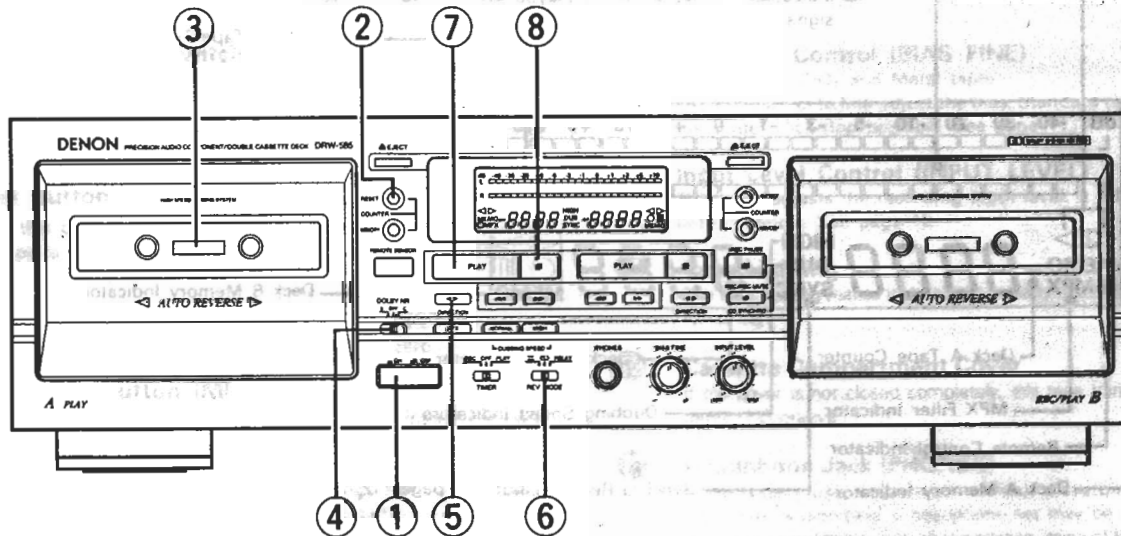

- 1 Press the POWER switch to the ON () position.
- 2 Press the EJECT () button to open the cassette compartment cover.
- 3 Load the cassette tape and close the cassette compartment cover.
- 4 When listening to a tape that has been recorded with Dolby noise reduction, set the DOLBY NR switch to match the system used at the time of recording.

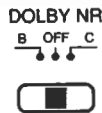

- 5 Press the Direction () button to select the direction of tape transport.

Transport Direction	Indicator
Forward	
Reverse	

- 6 Select the type of tape transport with the REVERSE MODE switch.



Mode	Switch position
To listen to one side only	
To listen to repeat playback of both sides	
To listen to continuous play back of both sides and both decks	RELAY

- 7 Press the PLAY button to begin playback.
- 8 Press the stop () button to stop the playback.
 - In the continuous playback mode (REVERSE MODE set to), playback of both tape sides will be repeated 5 times and then stop automatically.
 - If different types of Dolby noise reduction are used for record and playback, playback response will be adversely effected.
 - When power is turned off during tape transport, it may not be possible to remove the cassette by pressing the EJECT () button. In this case, turn on power again before you press the EJECT () button.

■ **RELAY PLAY (continuous playback of the tapes in deck A and deck B)**

- Load a cassette tape into deck A and B, and set the Dolby NR button correctly.

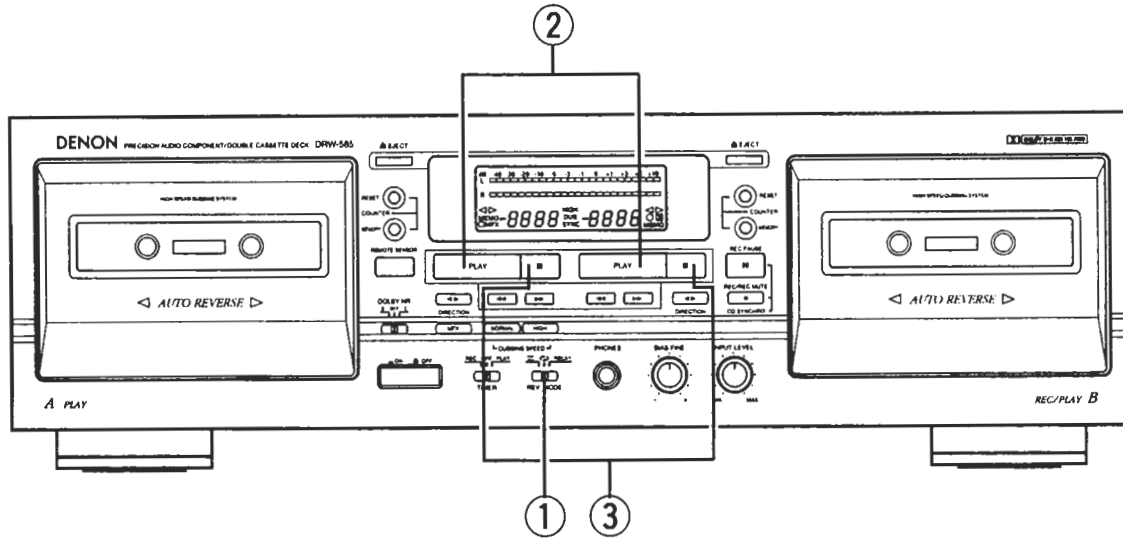

- ① REVERSE MODE set to "RELAY".
- ② Press the PLAY button of the deck you first wish to listen to.
- ③ To stop relay play, press the stop (■) button of the deck currently playing the tape.
 - Relay play will play decks A and B in succession for 5 cycles, upon which playback stops. When playback starts from deck B, when switching to deck A, the first deck A playback cycle will be counted as the second cycle. The completion of 5 cycles will always be at the opposite side of the tape in deck B.

■ **MUSIC SEARCH SYSTEM**

The music search system detects blank sections (lasting for at least 4 seconds) between selections in order to locate the beginning of selections in the forward or reverse direction.

1. To advance from the current selection to the beginning of the next selection (CUE):
 Press the PLAY button, keep it pressed in, and press the Fast Forward (▶▶) button when the tape is travelling in the forward (▷) direction. Press the PLAY button, keep it pressed in, and press the Rewind (◀◀) button when the tape is travelling in the reverse (◁) direction. The tape transport indicator flashes. The deck will skip the rest of the current selection and automatically resume play from the beginning of the next selection.
2. To repeat playback from the beginning of the current selection (REVIEW):
 Press the PLAY button, keep it pressed in, and press the Rewind (◀◀) button when the tape is travelling in the forward (▷) direction. Press the PLAY button, keep it pressed in, and press the Fast Forward (▶▶) button when the tape is travelling in the reverse (◁) direction. The tape transport indicator flashes. The deck will rewind the tape to the beginning of the current selection and automatically resume play from that point. This is very convenient for repeating playback of the current selection.

Notes on Music Search Operation:

The search functions operates by detecting comparatively long, blank sections approximately 4 to 5 seconds long, in between recorded selections. Therefore, the system may not operate normally in the following cases:

- Recordings with discontinuous speech or conversation.
- Recordings with long periods of pianissimo (softly played music).
- Recordings with long silences.
- Blank sections with a high level of noise.
- Blank sections shorter than 4 seconds.
- If noise-emitting appliances, such as electric razors, drills, refrigerators, etc., are operated nearby.
- REV close to the beginning of the program or CUE close to the ending.

RECORDING (DECK B only)

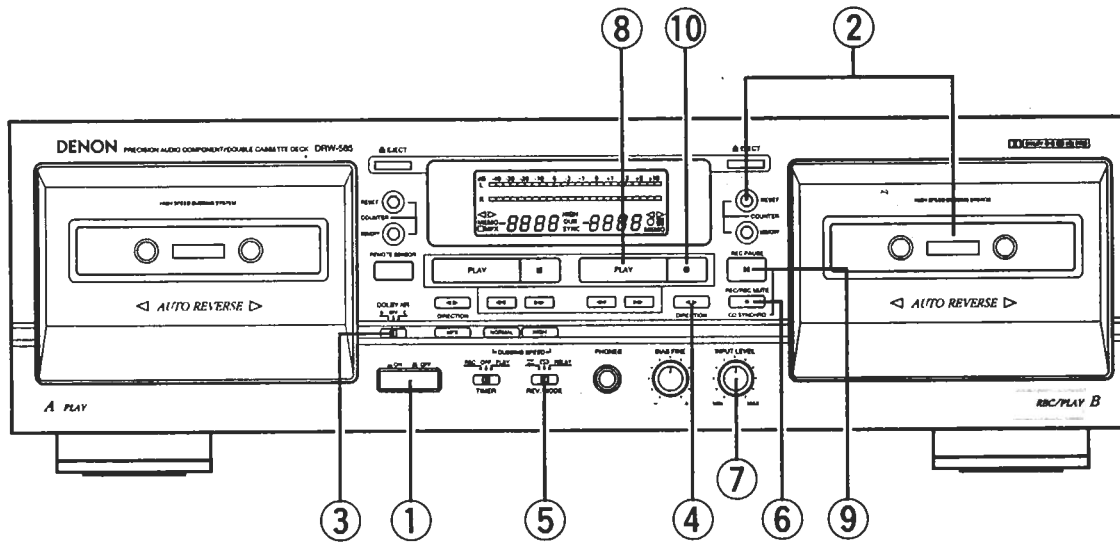

- Switch on your amplifier or receiver and the source component.
- Set the Tape Monitor switch on your amplifier or receiver to the SOURCE position.



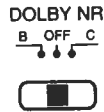





- 1 Press the POWER switch to the ON () position.
- 2 Load the cassette tape.
(Check that the erasure prevention tabs of the cassette housing have not been broken off.)
- 3 Move the DOLBY NR switch and select the Dolby NR type that suits the recording.





- 4 Press the Direction () button to select the direction of tape transport.
- 5 Select the type of tape transport with the REVERSE MODE switch.

Mode	Switch position
To record on only one side	
To continuously record on both sides	 or RELAY

- 6 Press the REC/REC MUTE () button to set the recording pause mode. The  indicator will light up.
- 7 Adjust the recording level with the INPUT LEVEL control while watching the Peak Level Meter
- 8 Press the PLAY button to start the recording. The PLAY ( or ) and the  indicator will light during recording.
- 9 To pause the recording, press the REC PAUSE () button. Press the PLAY button to resume recording.
- 10 To stop recording, press the stop () button.

Caution:

- Be careful not to erase important recordings by mistake. Inadvertent start of recording will happen in the following cases:
 1. If the PLAY button is pressed while the  indicator lights, recording starts.
 2. If the PLAY and REC/REC MUTE () button are pressed at the same time, recording starts.
 The best way to avoid accidental erasure is to break off the two erasure prevention tabs on the cassette housing.

■ PROPER RECORDING LEVEL

A too high recording level can saturate the tape and cause distortion. On the other hand, if the recording level is set too low, soft passages will be marked by residual noise. A proper recording level is the single most important factor for making well balanced recordings.

Guideline for maximum recording level

TYPE I (Normal)	0 dB level on peaks
TYPE II (CrO ₂)	+1 dB level on peaks
TYPE IV (Metal)	+3 dB level on peaks

Note: The optimum recording level differs depending on the program source and the type of tape used.

■ RECORDING BIAS ADJUSTMENT

For best recording results, monitoring during recording and comparing different recordings using your own judgement are essential. The DENON cassette deck is equipped with a BIAS FINE control to assist you in setting the proper bias for different types and brands of tape. At the center stop-click position, the deck is set to the reference bias level for Normal, CrO₂ and Metal tape. If the resulting recording in this position has too much or too little high frequency content, adjusting the BIAS FINE control can be useful to achieve better results.

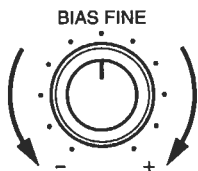

If the high frequencies (treble sounds) are to be boosted, turn the BIAS FINE control counter-clockwise to decrease the bias current. Turn the control clockwise to increase bias current.

By the use of this control, you can record tapes with a frequency response that will perfectly match your listening taste.

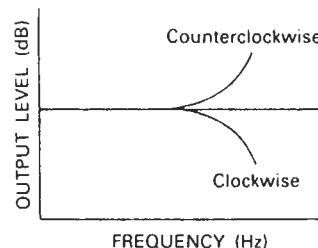

■ REC/REC MUTE AND REC PAUSE Button

1. To record a 5-second blank section during recording:
Press the REC/REC MUTE (●) button. A 5-second blank will be recorded and the deck will enter the recording standby mode.
2. To record a 5-second blank section during the recording standby mode:
Press the REC/REC MUTE (●) button from the recording standby mode. A 5 second blank will be recorded and the deck will enter the recording standby mode again.
3. To cancel recording of blank space:
Press the REC PAUSE (||) button. Blank space recording will be cancelled and the deck enters the recording standby mode.
4. To extend the blank section with another 5 seconds or more:
Simply press the REC/REC MUTE (●) button and the blank section will be increased with another 5 seconds.

■ DIMMER ADJUSTMENT

With the DRW-585, the brightness of the display can be adjusted in seven steps.

To make the display brighter, press the B deck's fast forward (▶▶) button while holding in the B deck's STOP button.

To make the display dimmer, press the fast rewind (◀◀) button while holding in the STOP button.

The display is initially set to the maximum brightness.



DUBBING (from deck A to deck B)

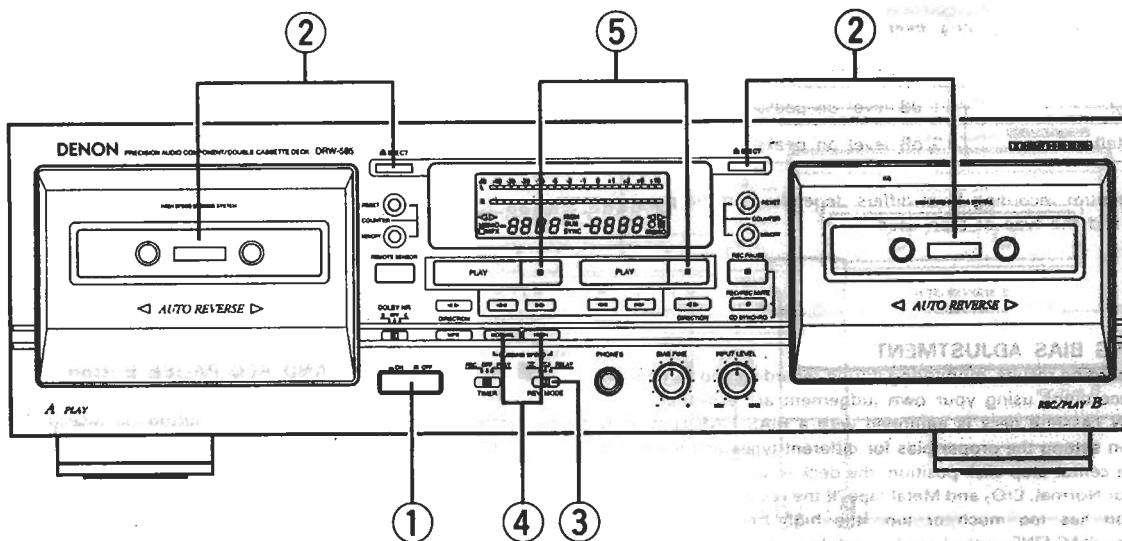

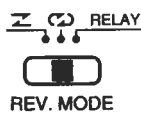

- Switch on the amplifier or receiver.
- Set the Tape Monitor switch on your amplifier or receiver to the TAPE position.



- ① Press the POWER switch to the ON () position.
- ② Load the cassette tape to be played in deck A and the one to be recorded in deck B.
- ③ Select the type of tape transport with the REVERSE MODE switch.



Reverse mode	Operation
	Dubbing is performed only for one side. The decks stop when either deck A or B reaches the end of the tape.
	The tape direction is reversed on each deck when they reach the end of the tape. (This is convenient for dubbing to a tape with a different length.)
RELAY	During dubbing of the side facing you, the deck that first reaches the end of the tape will stand by until the other deck reaches the end of the tape, then both decks will reverse the tape direction together. (Depending on the manufacturer, the length of tapes having the same recording time may differ somewhat. Setting this mode permits the arrangement of the beginning portion of the opposite side of the tape.)

- ④ To begin normal speed dubbing, press the DUBBING SPEED NORMAL button. The DUB indicator will light at this time. To high speed dubbing, press the DUBBING SPEED HIGH button. The HIGH indicator will light at this time.
- ⑤ To stop dubbing, press the stop () button of deck A or deck B.
 - When deck A is in the playback mode and deck B is in the stop condition, setting deck B to the recording pause mode will engage the normal speed dubbing pause mode. Dubbing is then started by pressing the PLAY button.
 - When dubbing, the recording level and the Dolby NR recording will be the same as those of the playback tape, regardless of the positions of the INPUT LEVEL control and the DOLBY NR button.
 - When listening to the playback sound during normal speed dubbing, the DOLBY NR switch remains off even if it is pressed.
 - The playback sound cannot be heard during high speed dubbing.
 - Operation using the REC/REC MUTE () and REC PAUSE () buttons of deck B is permitted during normal speed dubbing.
 - Buttons other than the stop () button cannot be used during high speed dubbing.

SYNCHRONIZED RECORDING FUNCTION

- Convenient synchronized recording can be performed when used in combination with a DENON CD player equipped for the synchronized recording function.
- SYNCHRO Jack Connection Connect the SYNCHRO Jack with a DENON CD player which is equipped with a SYNCHRO jack, then make a synchronized recording. Use the connection cord supplied with this cassette deck
- Switch on your amplifier or receiver and the CD player.
- Set the tape Monitor switch on your amplifier or receiver to the source position.

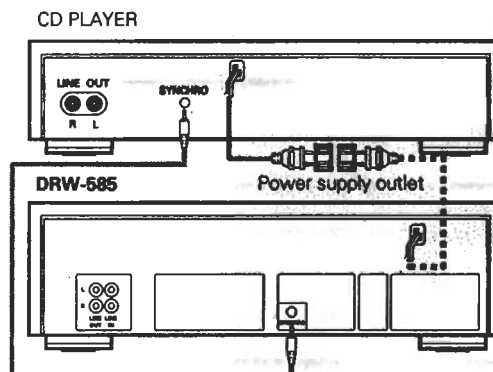

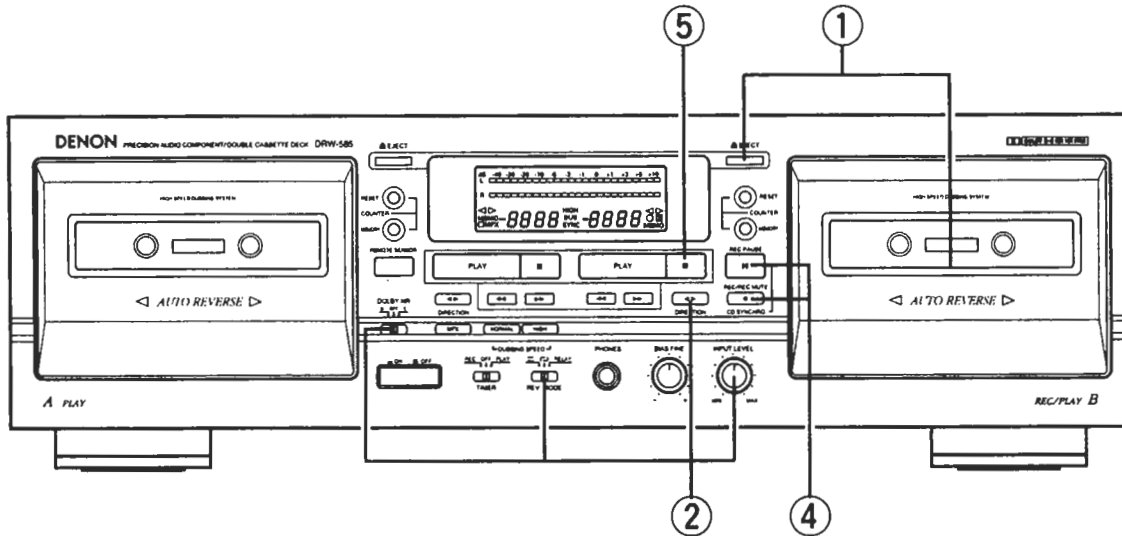

- ① Load the tape onto which you want to record into deck B, the disc you want to record into the CD player.
- ② Following the recording instructions on page 10, set the Dolby NR mode, the direction, the reverse mode and the input level.
- ③ Set the CD player to the stop or pause mode.
- ④ Press the REC/REC MUTE (●) button and REC PAUSE (||) button simultaneously. The cassette deck and CD player are automatically set to the synchronized recording mode. The "SYNC" indicator lights on the cassette deck and the synchronized recording mode is indicated on the CD player.
(For details, refer to the CD player's operating instructions.)
- ⑤ To stop synchronized recording, press the stop button on deck B and stop button on CD.
The synchronized recording mode is cancelled for both the cassette deck and CD player.
- ⑥ To stop synchronized recording temporarily, press the stop button on the CD player. A 5-second blank space is created on the tape, after which the recording pause mode is set. The "SYNC" indicator flashes. To resume synchronized recording, press the PLAY button on the CD player.

Note:

- If synchronized recording is started when the CD player is in a mode other than the stop or pause mode or when no disc is set, the "SYNC" indicator on the cassette deck flashes and the recording pause mode is set until synchronized recording is possible on the CD player.
- In the synchronized recording mode, only the STOP button on deck B will function.

Caution:

- Do not set the cassette deck to the synchronized recording mode when the CD player is in the play mode. Also, do not turn off the power of the cassette deck or the CD player during synchronized recording. Doing so can result in malfunction.
- During the editing operation, when using the editing functions on the CD player, be sure to select a tape with a sufficiently long recording time.
For the CD player's editing functions, refer to the CD player's operating instructions.

TAPE COUNTER AND MEMORY STOP

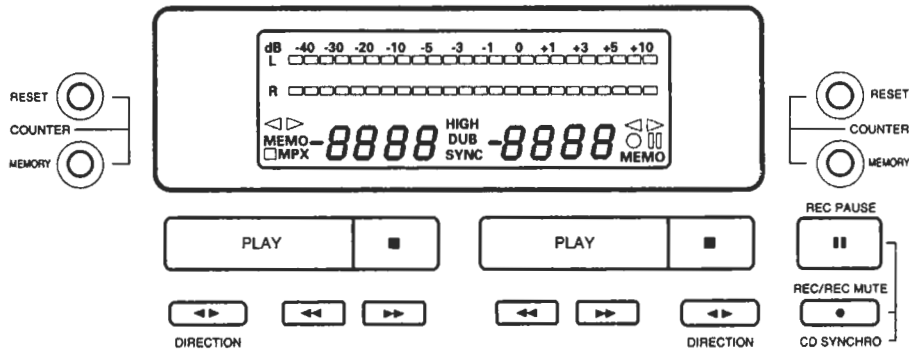

1) Operation of the Tape Counter

- (1) Press the RESET button to reset the counter to "0000".
- (2) By using the PLAY, FF, or REW functions, the reading of the counter will change to indicate index position.
 - During recording and playback operations, the counter is useful for noting the location of existing programs or positions where recording is to be started.
 - The reading of this counter does not correspond with that of any other deck.
- (3) deck A and deck B have the memory of their own counter.

2) MEMORY STOP Operation

- (1) During recording or playback, the Memory Stop feature can be used to locate a particular point on the tape. Press the COUNTER RESET button at the desired point.
- (2) Then Press the COUNTER MEMORY button, the MEMO indicator lights.

- (3) When the Rewind (◀) button is pressed during forward tape travel (▶), or the Fast Forward (▶▶) button is pressed during reverse tape travel (◀), the tape is rapidly rewound (or advanced) until the counter indication of "0000" is reached.
 - The Memory Stop feature will rewind or forward the tape to within -5 counts in the forward (▶) direction (from "0000" to "-0005") and to within +5 counts in the reverse (◀) direction (from "0000" to "0005"). After this, several seconds are required for corrective operations.
 - The Memory Stop function operates independently in both directions for deck A and deck B.

Caution:

If the memory stop operation is performed after repeated fast-forwarding or rewinding, the tape may not stop at the proper position.

TIMER RECORDING / PLAYBACK

Timer recording/playback can be made using any audio timer available on the market.

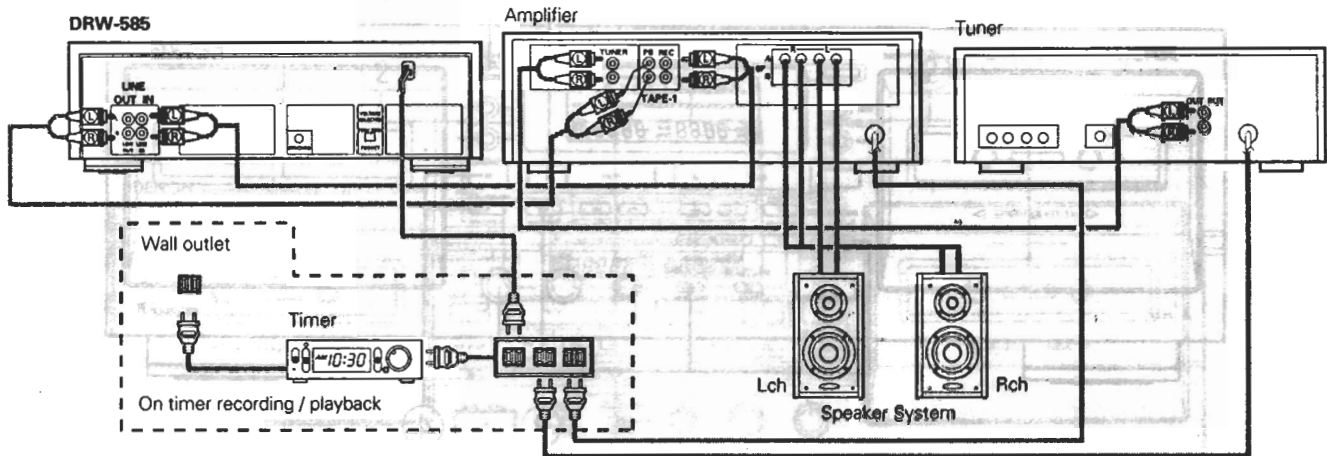

● Timer recording procedure

1. Make sure the connections are correct, especially the power supply connections.
2. Turn "on" the power switch of each appliance.
3. Tune the desired station on the tuner.
4. Load the tape for recording. (Make sure the erase prevention tab is not broken off; if it is, cover the hole with plastic tape).
5. Set the Dolby NR switch to the appropriate position.
6. Make sure the monitor switch to the SOURCE position.
7. Adjust the recording input level.
8. Set the starting position of the tape.
9. Set the timer switch (TIMER) to the "REC" side.



10. Set the audio timer to the desired time. The audio timer will turn the power supply on at the desired time.

* With the above procedures, timer controlled recording can be made. When the preset time comes, the power is supplied and the FM broadcast can be recorded.

● Timer playback procedure

1. Make sure the connections are correct, especially the power supply connections.
2. Turn "on" the power switch of each appliance.
3. Load the pre-recorded tape to be played back.
4. Set the Dolby NR switches to the appropriate positions.
5. Set the monitor switch of the Amplifier to the TAPE position.
6. Press the PLAY (▶) button and playback the tape; adjust the playback level.
7. Set the timer switch (TIMER) to the "PLAY" side.



8. Set the audio timer to the desired time. The audio timer will turn the power supply on at the desired time.

* With the above procedures, timer playback can be accomplished. When the preset time comes, the power is supplied and playback will start.

Note:

- Please read the operating instructions for the timer before use.
- If the timer recording or playback is not desired, be sure to switch the timer switch (TIMER) to "OFF".
- When using timers that allow several "on/off" operations, timer start functioning can continue an unlimited number of times until the tape in the machine is finished.

DOLBY B AND C NOISE REDUCTION SYSTEM

- The Dolby noise reduction system substantially reduces the tape background noise (hiss) inherent in the cassette medium. Dolby B NR is most widely in use. However Dolby C NR is a much more recent development and represents significant improvements over Dolby B NR.
- Tape background noise consists primarily of high frequency information, which is particularly annoying during soft passages. The Dolby NR system increases the level of low volume mid- and high-frequency signals during recording and reduces the level of these signals by an identical amount during playback. As a result, the playback signal is identical to the original source, but the level of background noise generated by the tape is greatly reduced.

- The operating principle of Dolby C NR is similar to that of Dolby B NR except for the encoding/decoding response curves. The noise reduction effect obtained with Dolby C NR is up to 20 dB, compared to 10 dB with Dolby B NR. In addition, Dolby C NR uses an anti-saturation network and spectral skewing circuitry for a significant improvement in the dynamic range of the mid- to high-frequencies.

DOLBY HX-PRO HEADROOM EXTENSION SYSTEM

This deck is equipped with the Dolby HX-PRO headroom extension system. Since the system functions automatically during recording, no switching operation or adjustment is required. The system is effective with any type of Normal, CrO₂ and Metal tape.

The Dolby HX-PRO headroom extension system functions during recording to raise the saturation level in the treble range. Therefore, most of the treble range components distorted or lost during recording on conventional cassette decks are more faithfully recorded on the new DENON cassette deck.

Features of the Dolby HX-PRO Headroom Extension System

- (1) Performance of Normal and CrO₂ tapes can be improved to very close of that offered by Metal tape.
- (2) The dynamics in the treble range are improved significantly.
- (3) Since no decoding is necessary during playback, the improved sound can be enjoyed on any type of tape deck, including portable players and car audio systems.
- (4) The system functions whether the Dolby B/C NR system is engaged or not.

MAINTENANCE

■ Head Cleaning

After long usage, tape coating or dust may adhere to the heads, causing deterioration of sound. Therefore, the parts depicted in the illustration should be cleaned regularly. Use a cotton swab moistened with a tape head cleaning solution (such as alcohol).

Note:

1. Some cleaning cassettes on the market have strong abrasive effects and may scratch the heads. Always use cotton swabs instead of cleaning cassettes.
2. Since the use of metal tape is apt to collect more dust on the heads, the heads should be cleaned more often to enjoy the best possible sound.

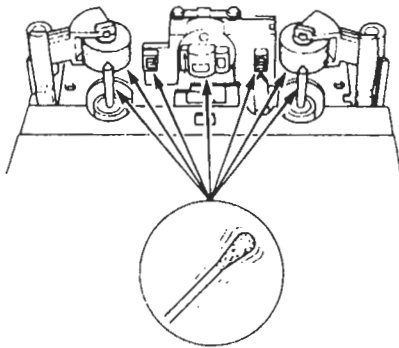

■ Cleaning the Pinch Rollers and Capstans

If the pinch rollers or capstans accumulate dust, tape transport may become unstable, as a result from slippage, during recording or playback. The tape can also be damaged if it gets entangled in the capstan.

Clean these parts with a cotton swab or a soft cloth moistened with a tape head cleaning solution (such as alcohol).

■ Demagnetizing the Heads

The heads will become magnetized after long usage or if strongly magnetized objects are brought near them. The result is a generation of noise, loss of the high frequency range, and in extreme cases erasure of treble components on pre-recorded tapes in combination with added noise.

Thus, the heads should be demagnetized at regular intervals. (Head demagnetizers are separately available from your dealer.)

■ How to Demagnetize the Tape Heads

1. Turn off the power.
2. Turn on the demagnetizer while it is at least 30 cm away from the heads. Bring the demagnetizer near the heads and slowly move it in small circles four or five times in front of each head, making sure you do not touch them.
3. Slowly move the demagnetizer away and turn it off when it is at least 30 cm away from the heads.

TROUBLESHOOTING

Check the following before you draw the conclusion that your Stereo Cassette Deck is malfunctioning.

1. Are all the connections correct?
2. Are all system components being operated correctly in accordance with the operating instructions?
3. Are the speakers and amplifier/receiver functioning correctly?

If the tape deck still does not function properly, check the symptom against the list below. If the symptom does not correspond to the check list, please contact your DENON dealer.

Problem	Cause	Remedy
Tape does not run	<ul style="list-style-type: none"> • Power cord is disconnected. • Tape is loose. • Cassette is not loaded properly. • Defective cassette. 	<ul style="list-style-type: none"> • Check power cord. • Tighten tape with a pencil, etc. • Load cassette properly. • Replace cassette.
Tape is not recorded when REC/REC MUTE (●) button is pressed.	<ul style="list-style-type: none"> • No cassette is loaded. • Erase prevention tabs are broken off. 	<ul style="list-style-type: none"> • Load cassette. • Cover holes with adhesive tape.
Sound is warbled and distorted.	<ul style="list-style-type: none"> • Heads, capstan or pinch roller are dirty. • Tape is wound too tight. • Recording input level is too high. • Tape is worn out and has "drop-outs". 	<ul style="list-style-type: none"> • Clean them. • Fast forward or rewind to loosen tape winding. • Adjust recording input level. • Replace tape.
Excessive noise	<ul style="list-style-type: none"> • Tape is worn. • Heads, capstan or pinch roller are dirty. • Heads are magnetized. • Recording input level is too low. 	<ul style="list-style-type: none"> • Replace them. • Clean them. • Demagnetize heads. • Adjust recording input level.
High frequency range (treble) is emphasized.	<ul style="list-style-type: none"> • Dolby NR switch is set improperly. 	<ul style="list-style-type: none"> • Set Dolby NR Switch properly.
High frequency range (treble) is lost.	<ul style="list-style-type: none"> • Heads are dirty. • Tape is worn. 	<ul style="list-style-type: none"> • Clean them. • Replace tape.
The cassette tape cannot be removed.	<ul style="list-style-type: none"> • If the POWER switch is turned off either during recording or playback and the unit is stopped, there may be cases when the cassette cannot be removed, even if the EJECT (▲) button is pressed. 	<ul style="list-style-type: none"> • Turn the POWER switch ON (—) again, and then press the STOP (■) button. • Now, press the EJECT (▲) button to remove the cassette tape.

SPECIFICATIONS

Type	Vertical tape loading; 4-track 2-channel stereo double cassette deck	Input LINE	80 mV (-20 dBm) input level at maximum
Heads	Play back head x 1 recording/playback head x 1 Erase head (Double-gap ferrite) x 1	Output LINE	Input impedance: 50 kΩ /kohms unbalanced 775 mV (0 dB) output level at maximum (with 47 kΩ /kohms load, recorded level of 200 pwb/mm)
Motors	DC servo motor x 2	PHONES	1.2 mW output level at maximum (optimum load impedance: 8 Ω /ohms ~ 1.2 kΩ /kohms)
Tape Speed	4.8 cm/sec.	Power Supply	60 Hz, voltage is shown on rating label
Fast Forward, Rewind Time	Approx. 110 sec. with a C-60 cassette	Power Consumption	16 W
Recording Bias	Approx 105 kHz	Dimensions	434 (W) x 135 (H) x 263 (D) mm (17-3/32" x 0-00/00" x 00-00/00")
Overall S/N Ratio (at 3% THD level)	Dolby C NR on: more than 74 dB (CCIR/ARM)	Weight	4.0 kg (00 lbs)
Overall Frequency Response	20 ~ 17,000 Hz ±3 dB (at -20 dB, Metal tape)		
Channel Separation	More than 40 dB (at 1 kHz)		
Wow & Flutter	0.08% WRMS, ±0.14% w. peak		

* Above specifications and design are subject to change without prior notice.

Dolby noise reduction and HX Pro headroom extension manufactured under license from Dolby Laboratories Licensing Corporation. HX Pro originated by Bang & Olufsen.

"DOLBY", the double-D symbol  and "HX PRO" are trademarks of Dolby Laboratories Licensing Corporation.

NIPPON COLUMBIA CO., LTD.

14-14, AKASAKA 4-CHOME, MINATO-KU, TOKYO 107-8011, JAPAN

Telephone: (03) 3584-8111

Cable: NIPPON COLUMBIA TOKYO Telex: JAPANOLA J22591