

WIRING DIAGRAM

CPT4-800 • CPT4-1200 • CPT4-1400 • CPT4-1700

2Channel mode

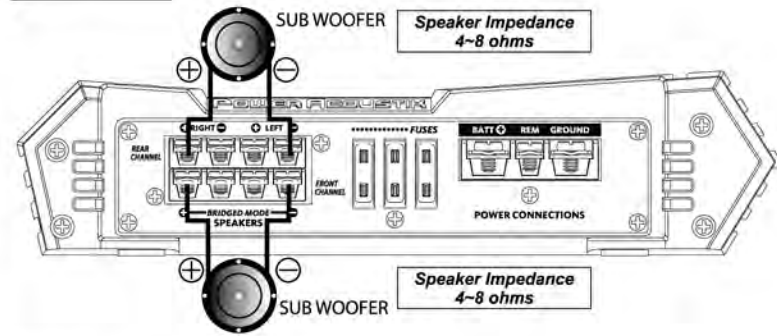

Tri mode

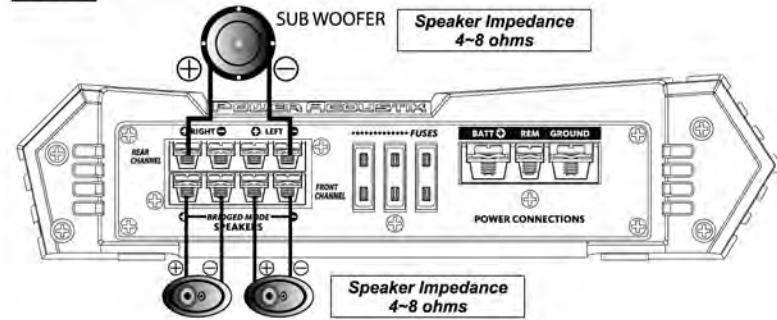

Stereo mode

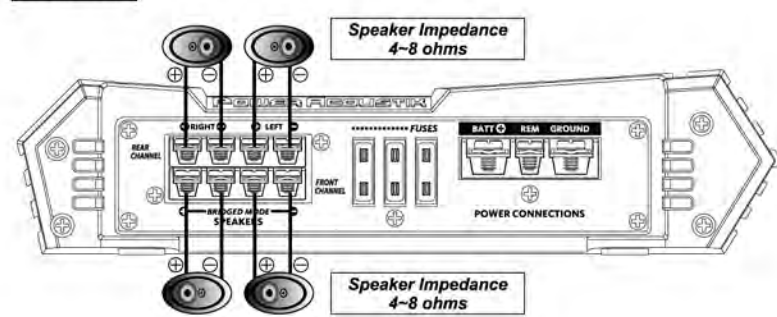

TURNING ON THE AMPLIFIER

The amplifier automatically turns on a few seconds after you turn your vehicle's ignition switch to ACC or ON or turn on your auto sound system, depending on how you wired the system. The POWER Indicator on the top of the amplifier lights when the amplifier is on.
Important: Your amplifier requires 30 amps or more of power from your vehicle's battery during operation. To protect your battery from discharging, do not operate the amplifier unless your vehicle is running.

ADJUSTING THE AUDIO LEVEL

For the best performance, you must set GAIN(MIN/MAX) on the side of the amplifier to adjust the level of the audio signals that enter the amplifier.

1. Use a screwdriver to turn GAIN(MIN/MAX) fully counterclockwise to MIN.
2. Turn the auto sound system's volume control to about one third of its full range.
3. Adjust GAIN(MIN/MAX) to a comfortable listening level.
4. Turn up the auto sound system's volume control until the sound begins to distort. Then immediately turn the volume down to a point just before where the distortion began.

Caution: Never turn up the auto sound system's volume control more than needed to adjust the audio level, more than two thirds of its maximum volume.
5. Adjust GAIN(MIN/MAX) until the sound is at the maximum level you want the amplifier to produce.
6. Adjust the auto sound system's volume control to a comfortable listening level.

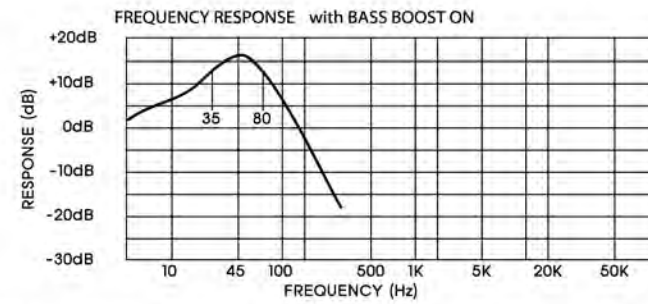

NOTE: Raising the Bass Frequency allows higher frequencies to reach the bass speakers centered around 45Hz. This "BUMP" can have a dramatic effect on the bass system's apparent volume. Use caution! When adjusting this control as serious subwoofer damage may result from overpowering or overexcursion.

TROUBLE SHOOTING

SYMPTOMS	CHECK	REMEDY
NO SOUND	Is the power LED illuminated? (NO)	Check all fuses to amplifier. Be sure Turn-on lead is connected. Check signal leads. Check gain control. Check Tuner/Deck volume level. Clean contacts on fuse holders.
	Is the Diagnostic LED illuminated? (YES)	Check for speaker short or amplifier overheating.
AMP NOT SWITCHING ON	No power to power wire	Repair power wire or connections.
	No power to remote wire with receiver on	Check connections to radio.
	Burnt or broken fuse	Replace fuse
NO SOUND, ON ONE CHANNEL	Check Speaker Leads	Inspect for short circuit or an open connection.
	Check Audio Leads	Reverse Left and Right RCA inputs to determine if the problem is occurring before the amp.
AMP TURNING OFF MEDIUM/HIGH VOLUME	Check Speaker load impedance	Be sure proper speaker load impedance recommendations are observed. (If you use an ohmmeter to check speaker resistance, please remember that DC resistance and AC impedance may not be the same.)
PROTECTION LAMP ON	Shut down	Turn radio down. Wait for AMP to cool.
	Speaker wires shorted	Separate speaker wires and insulate.

WARNING

Investigate the layout of your automobile through before drilling or cutting any holes. Take care when you work near the gas tanks, lines, or hydraulic lines, and electrical wiring. Don't use power amplifier without securely mounting it. Attach this system securely to the automobile to prevent damage, particularly in the event of an accident. Don't mount this system so that the wire connections are unprotected or are subject to pinching or damage from nearby objects. The +12V DC power wire must be fused at the battery positive terminal connection. Before making or breaking power connections at this system power terminals, disconnect the +12V wire at the battery end. Confirm your radio/cassette player and/or other equip is turned off while connecting the input jacks and speaker terminals. If you need to replace the power fuse, replace it only with a fuse identical to that supplied with the system. Using a fuse of different type or rating may result in damage to this system which isn't covered by the warranty.



POWER ACOUSTIK



Owner's Manual

4 Channel Amplifier (2ohm stable stereo)

- CPT4-800
- CPT4-1200
- CPT4-1400
- CPT4-1700

INTRODUCTION

INTRODUCTION

Thank you for purchasing **POWER ACOUSTIK** amplifier.

It is a state-of-the-art product carefully designed and manufactured for vehicle use and has been thoroughly tested to ensure consistent reliable performance.

POWER ACOUSTIK Amplifiers provide high-performance sound reinforcement for your mobile audio equipment. Its versatility enables compatibility with Frequency Dividing Crossovers, and other audio processors in a customized system. The Multimode bridging capabilities allow flexibility in hosting several different speaker configurations.

To achieve optimum performance & longevity, it is highly recommended that you read and apply the advice in this Owners Manual before beginning installation.



FEATURE

FEATURES

CPT4-800 • CPT4-1200 • CPT4-1400 • CPT4-1700

- Amplifier type : Class-AB 20hm stable stereo
- Tri-mode capable
- Channel Design : 3, 4 or 2 Channel
- Power Supply Design : Full MOSFET DC-DC PWM Power Supply
- Current Protection : 4 way protection
- Adjustable Gain Control : 0.25V ~ 6V
- Crossover : Adjustable Low-pass (Rear Channel)
- Crossover : Adjustable High-pass (Front Channel)
- Crossover : Switchable selected Bass boost (Rear Channel)
- RCA Input : Ni Plated RCA input Connections
- 4 Gauge Power & Ground Connections

1

SPECIFICATION

SPECIFICATIONS

MODEL	CHANNEL	RMS@4Ωrms	RMS@2Ωrms	Bridged @4Ωrms	Max. Power	DIMENSIONS (L) x (W) x (H)	FUSE
CPT4-800	4	80W x 4CH	100W x 4CH	200W x 2CH	800Watt	13" x 9.8" x 2.3"	30A
CPT4-1200	4	100W x 4CH	125W x 4CH	250W x 2CH	1200Watt	14" x 9.8" x 2.3"	20A x 2
CPT4-1400	4	120W x 4CH	150W x 4CH	300W x 2CH	1400Watt	15" x 9.8" x 2.3"	20A x 2
CPT4-1700	4	150W x 4CH	190W x 4CH	380W x 2CH	1700Watt	17" x 9.8" x 2.3"	30A x 2

CONTROLS & FUNCTIONS

CONTROLS & FUNCTIONS

CPT4-800 • CPT4-1200 • CPT4-1400 • CPT4-1700

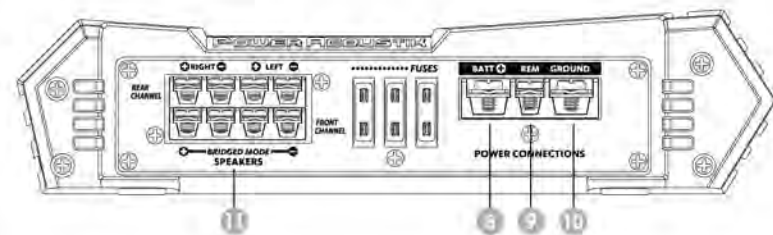
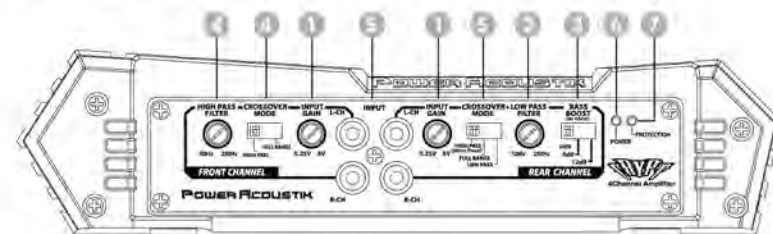

2

CONTROLS & FUNCTIONS

CONTROLS & FUNCTIONS

1. Input Level Adjustment



This control adjusts the amplifier's input sensitivity. Input sensitivity is variable from 250 Millivolts to 6 volts. Clockwise increases sensitivity. Counterclockwise decreases sensitivity. The amplifier can be driven to full power with a wide range of signal levels. A lower signal level will require increased sensitivity for full power. A higher signal level will require decreased sensitivity. Avoid setting sensitivity lower than necessary as this would introduce unwanted distortion.

2. Variable cross-over (low pass only)



It built-in 12dB/octave butter worth filter with a cross-over point variable 50Hz to 250Hz.

3. Bass boost Control (Tri-mode)



These can select tri mode by switch conveniently. The first mode 45Hz 6 dB.

4. High Pass Filter Control



Variable High Pass Filter (50Hz - 250Hz)
For use as a dedicated mid high range channel, set Filter Switch to "HIGH PASS".
The Input Circuit filters out all Frequencies Below 50Hz ... 250Hz.

5. Low Level Input & OUT RCA Jacks



In case of channel changes connecting, Sound can be sounded strange.

6. Power LED Indicator (Green)



Power : This Green LED will illuminate when the amplifier is turned "ON".
If it fails to illuminate, check the power connections to the amplifier and fuses.

3

7. Protection LED Indicator (Red)



Protection : The amplifier protection circuitry will disable the amplifier ; if input overload, short circuit or extremely high temperature conditions are detected. When the protection mode is in operation, the LED Indicator on the side panel will be illuminated, indicating the amplifier has gone into a self-preservation mode.

If you observe that the Protection LED is lit, please check the system carefully to determine what has caused the protection circuit to engage. The amplifier can be reset by turning the remote power off and then on again. If the amplifier shuts down due to a thermal overload condition, please allow it is cool down before restarting. If the amplifier shuts down because of an input overload or short circuit, be sure to repair these conditions before attempting to power up the amplifier again.

8. B+ Terminal (Battery positive)

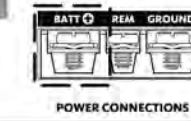

Due to the power requirements of the Amplifier, this connection should be made directly to the positive(+) terminal of battery. For safety measure, install an in-line fuse holder (not included) as close to the battery positive(+) terminal as possible with an amperage rating : not to exceed total value of fuses on AMP.

9. Remote Power ON

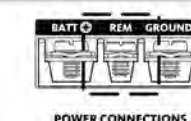

In between the power and ground is remote turn on terminal. This terminal must be connected to a switched +12Voltage source. You need to use at least 18gauge to connect remote turn on.

10. B-Terminal (Chassis ground)

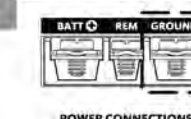

To avoid unwanted ignition noise caused by ground loops, it is essential that the Amplifier be grounded to a clean, bare, metal surface of the vehicles chassis.
Note : GROUND WIRE SHOULD NOT BE EXTENDED MORE THAN 3FT (1METER) IN SOME CASES !

11. Speaker Terminals

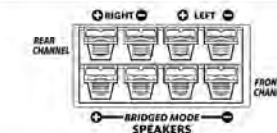

The heavy duty, nickel-plated clamp wire connectors (+ and -) Will accommodate at least 12 gauge to spade or ring style connectors.

4

PLANNING & MOUNTING YOUR SYSTEM

PLANNING & MOUNTING YOUR SYSTEM

The mounting position of your Amplifier will have a great effect on its ability to dissipate the heat generated during normal operation. Under normal conditions, the heatsink will dissipate sufficient heat to avoid thermal shutdown. However please do not install the amplifier in a wooden box or similar device, as this will prevent heat dissipation into the atmosphere.

Temperatures in car trunks have been measured as high as (155°F) in the summer time. Since the thermal shut down point for the amplifier is (158°F) it is easy to see that it must be mounted for maximum cooling capability. To achieve maximum advantage of convection air flow in an enclosed trunk, mount the amplifier in a horizontal position.

Cooling requirements are considerably relaxed when mounting inside the passenger compartment since the driver will not often allow temperatures to reach a critical point. Floor mounting under the seat is usually satisfactory as long as there is at least 1 inch of clearance (2.54cm) above the Amplifier's fins for ventilation.

- Select a suitable location that is convenient for mounting, is accessible for wiring, and has ample room for air circulation and cooling.
- Use the amplifier as a template to mark the mounting holes. Remove the Amplifier and drill holes. Use extreme caution, inspect underneath surface before drilling!
- Secure the Amplifier using the screws provided.

Self-Tapping Screw (4x20)

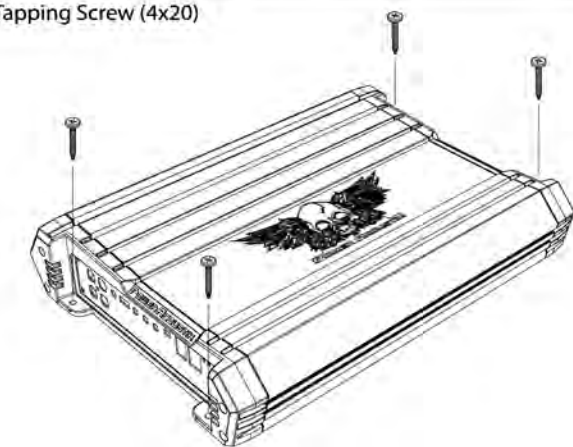

5