

# Digital Audio Receiver Accessory Kit

## Installation Guide

### OWNER'S RECORD

The model number is located on the bottom and serial number also on the bottom. Record the serial number in the space provide below. Refer to these numbers whenever you call upon your Sony dealer regarding this product.

Model No. \_\_\_\_\_

Serial No. \_\_\_\_\_

*DRN-XM01C2/DRN-XM01R2/  
DRN-XM01H2/  
DRN-XM01CK2/  
DRN-XM01HK2*



Sony Corporation ©2002 Printed in Japan

For customers in the USA  
Please register this product on line at <http://www.sony.com/productregistration>.  
Proper registration will enable us to send you periodic mailings about new products, services, and other important announcements. Registering your product will also allow us to contact you in the unlikely event that the product needs adjustment or modification. Thank you.

### For DRN-XM01H2/XM01HK2 Customers

#### WARNING

To prevent fire or shock hazard, do not expose the unit to rain or moisture.

You are cautioned that any changes or modifications not expressly approved in this manual could void your authority to operate this equipment.

#### INFORMATION

This equipment has been tested and found to comply with the limits for a Class B digital device, pursuant to Part 15 of the FCC Rules. These limits are designed to provide reasonable protection against harmful interference in a residential installation. This equipment generates, uses, and can radiate radio frequency energy and, if not installed and used in accordance with the instructions, may cause harmful interference to radio communications. However, there is no guarantee that interference will not occur in a particular installation. If this equipment does cause harmful interference to radio or television reception, which can be determined by turning the equipment off and on, the user is encouraged to try to correct the interference by one or more of the following measures:

- Reorient or relocate the receiving antenna.
- Increase the separation between the equipment and receiver.
- Connect the equipment into an outlet on a circuit different from that to which the receiver is connected.
- Consult the dealer or an experienced radio/TV technician for help.

This device complies with Part 15 of the FCC Rules. Operation is subject to the following two conditions: (1) This device may not cause harmful interference, and (2) This device must accept any interference received, including interference that may cause undesired operation.

### For All Models

#### Caution

- Do not operate the unit in a way that might divert your attention from driving safely. As a driver, you alone are responsible for safely operating your vehicle in accordance with traffic safety laws at all times.
- Do not install the unit where it may obstruct your view through the windshield or your view of your vehicle's indicator displays.
- Do not install the unit where it may hinder the function of safety devices such as an air-bag. Doing so may prevent the air-bag from functioning properly in the event of an accident.
- The installation and use suggestions contained in this manual are subject to any restrictions or limitations that may be imposed by applicable law— purchaser should check applicable law for any restrictions or limitations before installing and/or operating this product.
- Failure to follow these safety instructions and warnings may result in a serious accident.

## Parts for Installation and Connection

### for DRN-XM01C2

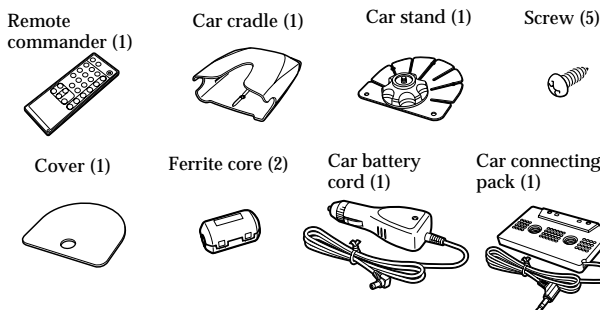

### for DRN-XM01R2

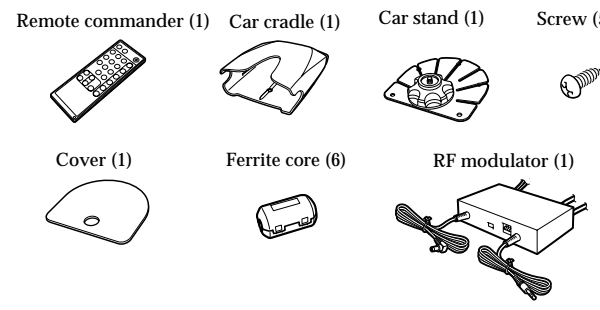

### for DRN-XM01CK2

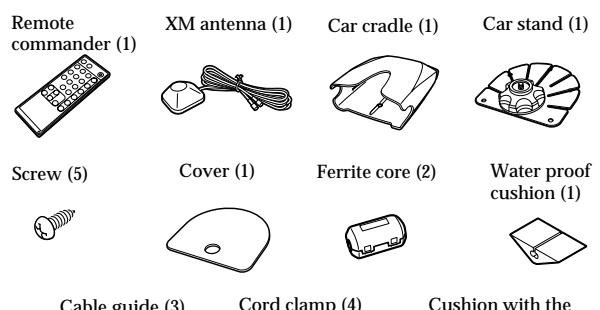

### for DRN-XM01H2/XM01HK2

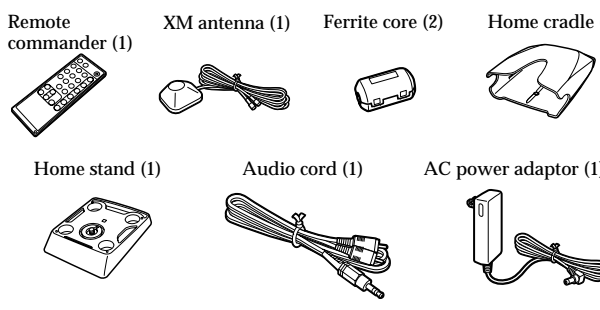

### For DRN-XM01C2/XM01CK2/XM01R2

## Installing the Cradle in your Car

Install the cradle with the supplied car stand.

- 1 Choose the mounting position, then shape the base of the stand to match the mounting surface.

Note  
Bend the base gently so there are no gaps between the base and the mounting surface.

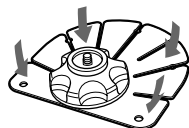

- 2 Clean the mounting surface well.

- 3 Peel off the protective film from the base of the stand and attach the base to the mounting surface. Make sure the base attaches to the mounting surface completely.

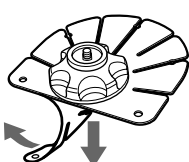

#### Notes

- The double-sided tape will not stick firmly if the mounting surface temperature is lower than 20°C (68°F). Use a hairdryer, etc. to warm up the mounting surface before mounting.
- Consider the mounting position carefully beforehand. If you change the position after mounting the double-sided tape will weaken.
- When removing the stand, preheat the mounting surface with a hairdryer then slowly pull up to remove, or use a commercially available solvent to remove the seal.

- 4 Fix the stand with the supplied screws.

Note  
Before drilling holes in the mounting surface, make sure there is nothing behind the mounting surface.



- 5 Remove the knob.

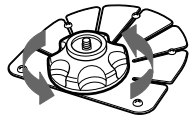

- 6 Attach the supplied cover over the base of the stand as shown below.

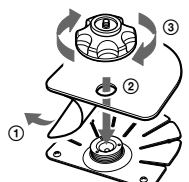

- 7 Attach the cradle to the stand.

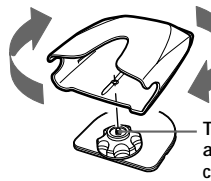

To the stand receptacle at the bottom of the cradle

- 8 Adjust the angle.

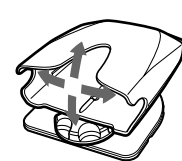

You can also adjust the angle after installing the main unit into the cradle.

#### Notes

- Do not install the unit in a location where it may be subjected to extremely high or low temperatures as the cabinet may become deformed or damaged. After parking your car, the temperature inside the car may raise considerably. Therefore, cover the cradle and the main unit with a white cloth or remove it from the cradle to avoid the direct sunlight.
- Do not install the cradle, the main unit and RF modulator in the following places:
  - Underneath the driver's seat: There may be a danger of the unit getting lodged under the brake pedal.
  - On the door or ceiling: There may be a danger of the unit falling down or obscuring the driver's view while driving.

### For All Models

## Affixing the ferrite cores

You must affix the cores (supplied with the model you purchased) in order to comply with Part 15 of the FCC Rules.

Wind the cord around the ferrite core once or twice, and then fasten the catch. Make sure that each ferrite core should be attached to the appropriate position as shown in the diagram below.

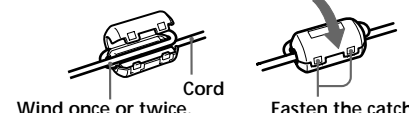

### Affixing the ferrite core to the RF modulator

Wind the cord around the RFC-8 ferrite core once, then fasten the catch.

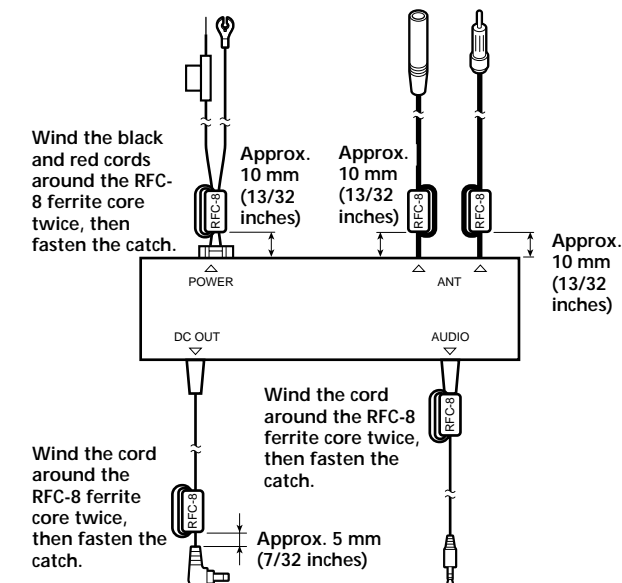

### Affixing the ferrite core to the XM antenna

Wind the cord around the RFC-8 ferrite core once, then fasten the catch.

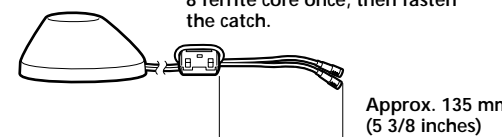

### Affixing the ferrite core to the AC power adaptor (AC-E60A)

Wind the cord around the RFC-8 ferrite core twice, then fasten the catch.

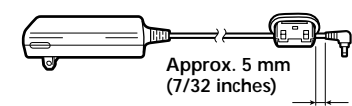

### Affixing the ferrite core to the car battery cord (DCC-E260)

Wind the cord around the RFC-8 ferrite core twice, then fasten the catch.

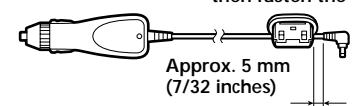

### For DRN-XM01CK2

## Installing the XM Antenna to your Car

The bottom surface of the XM antenna is made of a magnet. Install the antenna horizontally in a location where the radio wave from the satellite is not interrupted by the body of the car (E.g., roof or trunk lid).

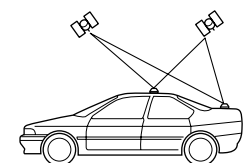

#### Notes on installing the antenna to your car

- Place the antenna on a flat surface as far away as possible from the edges of the trunk lid or the rear window.
- Before mounting the antenna, be sure to attach the supplied seal to the body of the car where the antenna will be mounted, then mount the antenna gently so that it does not damage the body of the car.
- Do not leave the cord slacked outside of the car.
- Use the cord clamp when fixing the cord, if required.
- When removing the antenna, do not pull it by the cord. This may cause the cord to come off the antenna due to the powerful magnet.
- The antenna cord is charged with the XM signal and the power supply to the antenna. When wiring the antenna, be careful not to pinch the cord in the moving parts of the car. The damaged cable may cause a malfunction of the antenna and the main unit.
- When washing the car in an automatic car wash, remove the antenna. Otherwise, it may damage the body of the car.

### Installing the antenna to an aluminum or plastic body

The antenna cannot be installed on an aluminum or plastic body with the magnet. In this case, use the supplied seal.

#### Painting the antenna

The antenna can be painted according to the body color of the car, however, do not use paint that contains metal powder. This may cause deterioration or inability of reception. Do not disassemble the antenna when painting.

#### Placement of the car antenna

Place the antenna on a flat and even surface on your car roof. The angle from the ground to the satellite should be about 20 - 60 degrees. If you place the antenna on the trunk lid, make sure your car roof does not block the satellite signal. Depending on where you live, you may be able to receive radio waves that are retransmitted by ground repeaters.

## Installing the Antenna on the Roof (recommended)

#### Figure of the top

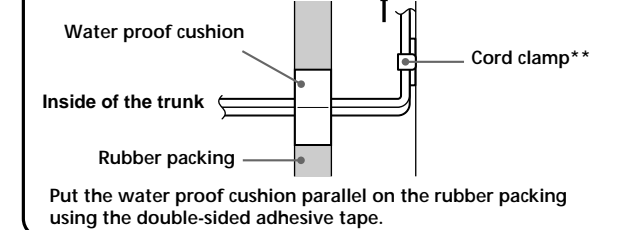

Put the water proof cushion parallel on the rubber packing using the double-sided adhesive tape.

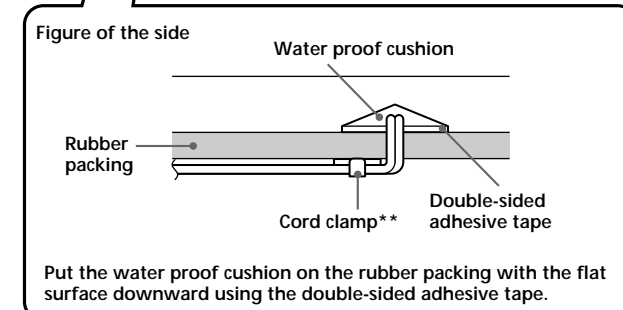
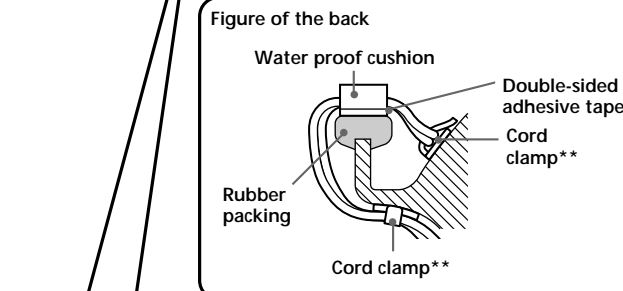
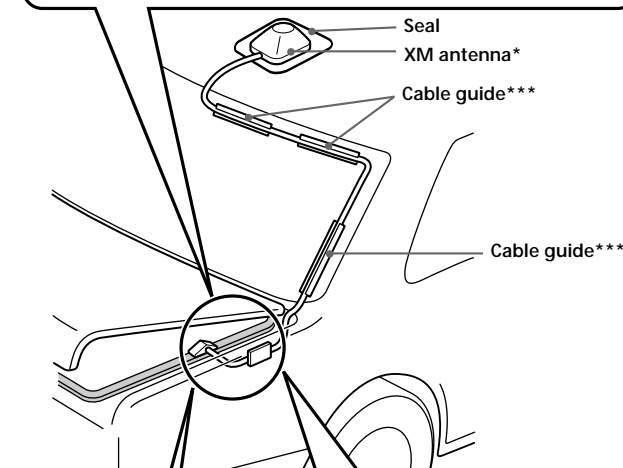

- \* Be sure to install the antenna firmly on a flat surface. Do not install on the corner of the roof.
- \*\* Be sure to install the cord clamp in a lower position where the water proof cushion is mounted. Otherwise, it will cause a water leak into the trunk.
- Clean the mounting surface before installing the cord clamp.
- Leave the installed cord clamp for 24 hours before installing the cord. Otherwise, the cord clamp may come off due to weak attachment.
- To install the cord, insert it into the cord clamp, then press the top of the cord clamp downward so that the cord is securely installed inside the cord clamp.
- \*\*\* Cut the cable guide, if required.
- It is difficult to attach the cable guide to a body or window which has fluorine resin coating.

## Leading the antenna cord into the car through the space between the door and body

When installing the antenna on the roof, you can also lead the antenna cord into the car through the space between door and body.

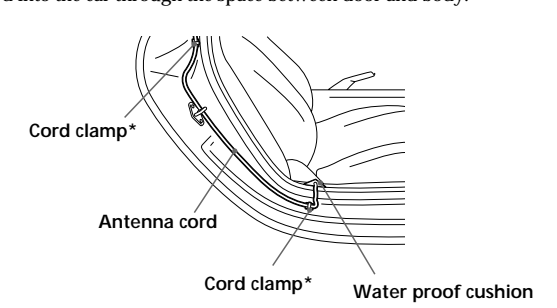

- \* Clean the mounting surface before installing the cord clamp.
- Leave the installed cord clamp for 24 hours before installing the cord. Otherwise, the cord clamp may come off due to weak attachment.
- To install the cord, insert it into the cord clamp, then press the top of the cord clamp downward so that the cord is securely installed inside the cord clamp.

## Mounting the Antenna with the Supplied Seal and Cushion with the Double-sided Adhesive Tape

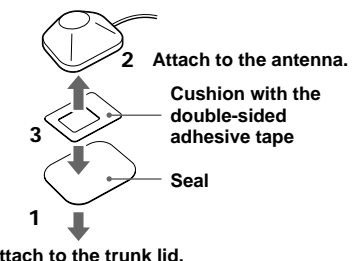

Note  
When removing the seal, preheat the mounting surface with a hairdryer then pull up slowly to remove, or use a commercially available solvent to remove the seal.

### Installing the Antenna on the Trunk Lid

- 1 Mount the antenna on the trunk lid. Clean the mounting surface before mounting.

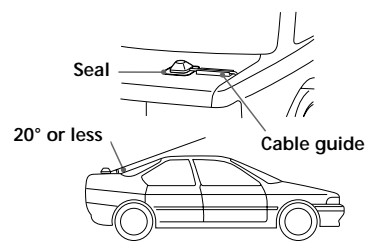

- 2 Mount the water proof cushion on the right or left side of the trunk lid. To prevent rain water leakage inside the car along the cord, mount the water proof cushion above the rubber packing when the trunk lid is closed.

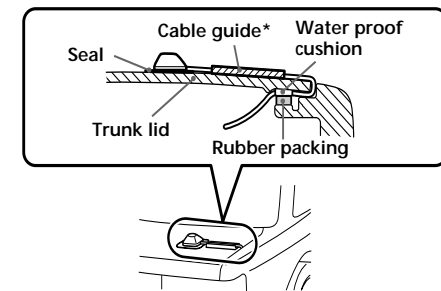

- \* Cut the cable guide, if required.
- It is difficult to attach the cable guide to a body or window which has fluorine resin coating.

<http://www.sony.net/>

LIMITED WARRANTY  
(Portable Audio)  
FOB 30\$以上

## Connecting the Unit to the Cigarette Lighter Socket

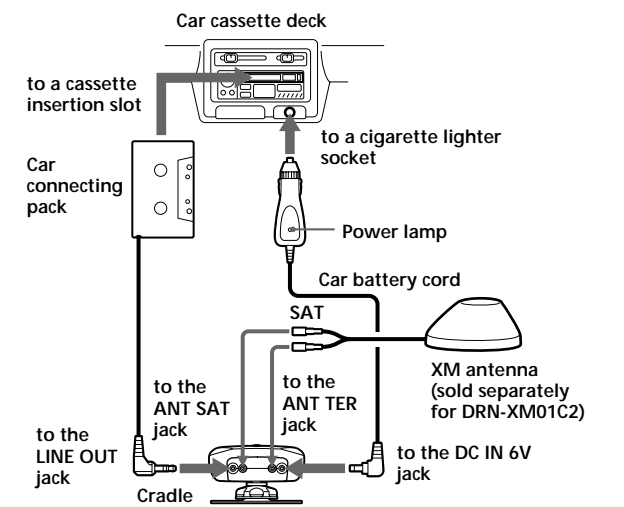

When the electric power is supplied to the car battery cord, the power lamp lights up.

- Notes**
- Route the cords so that they will not interfere with your driving.
  - Take care not to accidentally insert a portion of the car connecting pack cord into the cassette insertion slot. This may cause the cord to break or damage the car cassette deck.
  - To disconnect the cord from your audio equipment, pull it out by grasping the plug. Never pull it by the cord.
  - If the inside of the cigarette lighter socket is dirty with cigarette ash, the cigarette lighter plug may be heated due to abnormal contact. Be sure to clean the inside of the cigarette lighter socket before inserting the plug.
  - After using the receiver, eject the car connecting pack from the car cassette deck and disconnect the car battery cord from the receiver and the cigarette lighter socket.
  - Do not use the receiver when the car's engine is not running.

## Using the Car Connecting Pack

- Turn down the volume of the car cassette deck.
- Set the tape selector to the normal (TYPE I) position, and the DOLBY NR, REPEAT, or BLANK SKIP switch to the OFF position if such are equipped.
- Insert the car connecting pack into the cassette insertion slot.
- Start playback on the car cassette deck.
- Adjust the volume.

If no sound is heard or the car connecting pack is removed, change the playback direction on the car cassette deck.

**To Remove the Car Connecting Pack**  
Press the (eject) button of the car cassette deck.

**Note**  
You cannot use this car connecting pack with certain car cassette decks.

## Fuse Replacement

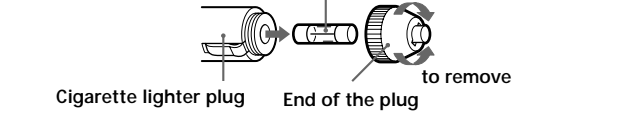

- Pull the cigarette lighter plug out of the cigarette lighter socket.
- Detach the end of the plug by turning it counterclockwise.
- Replace the fuse with a new one.
- Reattach the end of the plug by turning it clockwise firmly.

- Notes**
- When replacing the fuse, be sure to use one with the correct amperage, as stated on the fuse case. (1 A, 125 V, 20 mm)
  - Do not use a piece of wire instead of a fuse.
  - If the replaced fuse blows again, consult your dealer.

## Connecting the Unit to your Car with a RF Modulator

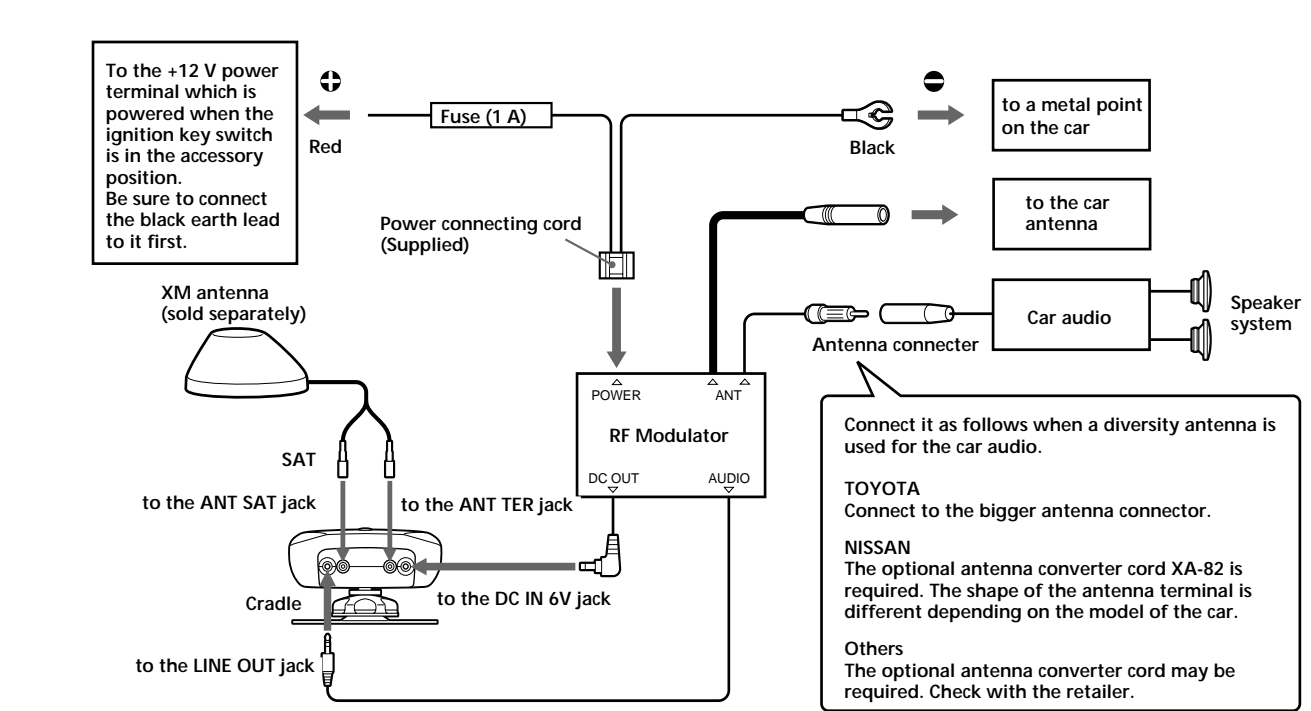

## Fuse Replacement

If the fuse blows, check the power connection and replace the fuse. If the fuse blows again after replacement, there may be an internal malfunction.

## Setting the POWER SELECT Switch

This RF modulator supplies power to the receiver and detects the on/off state by monitoring the load of the power. When the receiver is turned on, the RF modulator automatically cuts off the antenna line and directly outputs the sound of the receiver to the car audio with the selected FM frequency. This prevents the sound from disturbing the FM broadcast signal. When the receiver is turned off, the antenna line is connected to the car audio. Besides, you can set the RF modulator to always cut off the antenna line and output the XM radio sound to the car audio, in this case, you cannot hear the normal FM broadcast.

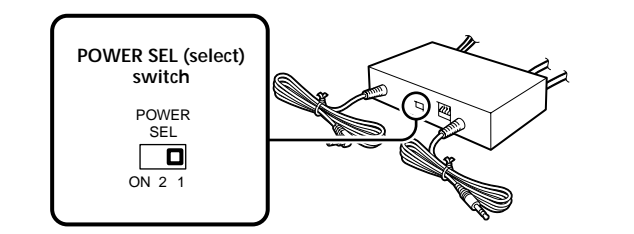

- Normal use (detecting more than 100 mA load)
  - Not used (detecting more than 50 mA load)
- ON : Not used (cutting off the antenna line)

## Changing the Transmitting Frequency

This unit changes the signal of the XM satellite radio broadcast into an FM frequency and outputs the sound through an FM tuner. There may be interference noise while playing the receiver, when the frequency selected for the receiver is used for transmitting the actual FM broadcast. In such a case, change the transmitting frequency on the unit. The factory-set is 87.9 MHz.

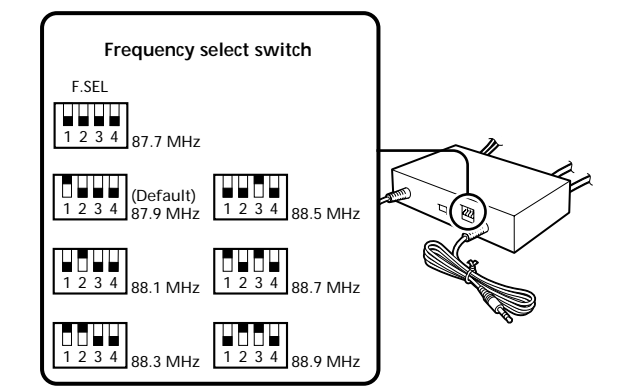

**Note**  
When you change the frequency on the unit, be sure to tune your FM tuner to the newly selected one.

## When the Installation and Connections Have Been Made

**Securing the Cord**  
After installing and connecting the unit, run cord so as not to interfere with the operation of the vehicle.

Run and fix the cord on the passenger side of the center console with the supplied cord clamp.

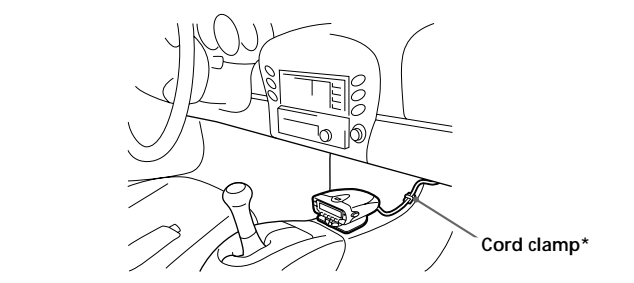

- Clean the mounting surface before installing the cord clamp.
- Leave the installed cord clamp for 24 hours before installing the cord. Otherwise, the cord clamp may come off because of weak attachment.

**Note**  
Make sure the cord does not get caught in the sliding rails under the front seats or the front doorsills as this may cause the cord to be severed.

## Using the Unit on House Current

Use the AC power adaptor and the audio cord supplied with DRN-XM01H2/XM01HK2.

**Note**  
To disconnect the cord from your audio equipment, pull it out by grasping the plug. Never pull it by the cord.

## Attaching the Home Stand

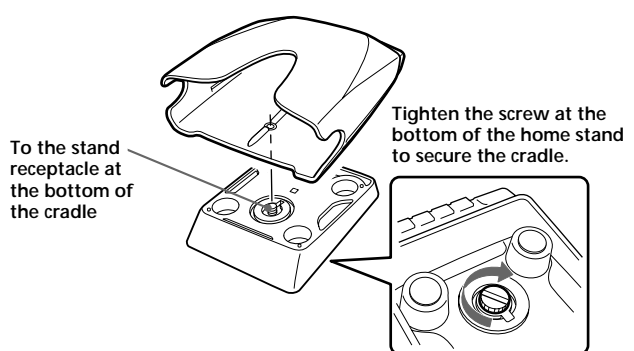

## Connecting the Unit

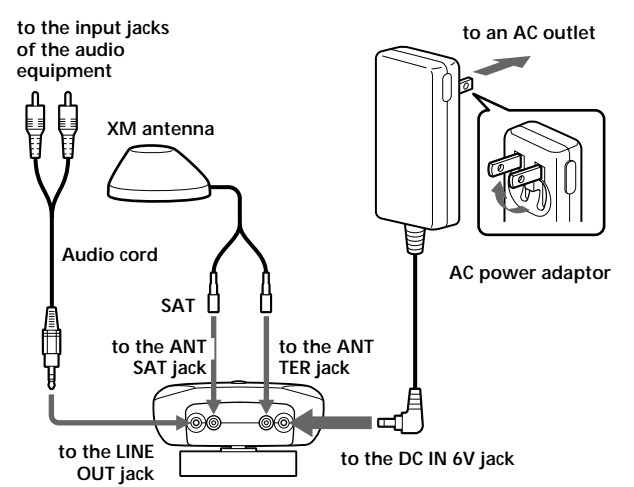

**Note on the DC plug of the AC power adaptor**  
This AC power adaptor uses a unified polarity type plug (JEITA standard). Damage will occur if it is connected to a DC power input jack without the polarity symbol or with another symbol. If the jack of your audio equipment does not match the AC power adaptor, consult your dealer.

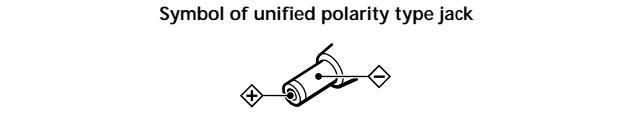

## Placement of the Home Antenna

The satellite is located in the south sky. Place the antenna as follows for proper reception:  
 - Outside the house  
 - Place the antenna in an area where there are no obstacles within 20 - 60 degrees facing the southern sky.  
 - On a flat surface so that it is parallel to the ground.  
 When you place it indoors, or if there is a building or tree in the direction of the satellite, the antenna may not be able to receive the radio wave. Depending on where you live, you may be able to receive radio waves that are retransmitted by ground repeaters.

## Replacing the Lithium Battery into the Remote Commander

Replace the battery when the buttons on the remote commander do not work. Remove the old battery and insert a new one.

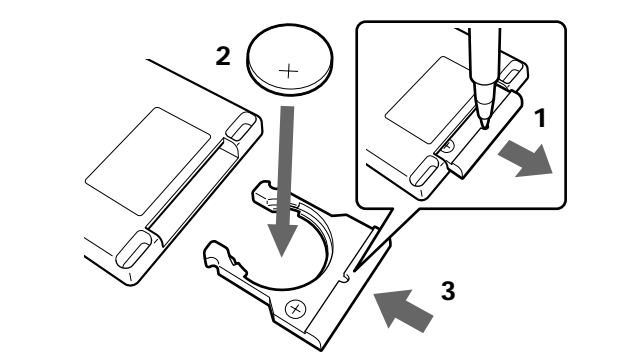

- Insert a long and thin object into the hole, then pull out the lithium battery holder.
- Place the lithium battery with the positive (+) side facing up.
- Insert the battery holder into the remote commander until it clicks.

## Battery life

Sony lithium battery CR2025	(Approx.)
	1 year

- Notes on lithium battery**
- Keep the lithium battery out of reach of children. Should the battery be swallowed, immediately consult a doctor.
  - Wipe the battery with a dry cloth to assure good contact.
  - Be sure to install the battery in the correct polarity position.
  - Do not hold the battery with metallic tweezers, as doing so may cause a short-circuit.
  - Do not break up the battery or throw it into a fire, which might cause it to explode.
  - Carefully dispose of the used battery.

**Note**  
When the unit is not to be used for a long period of time, remove the battery to avoid damage from battery leakage and corrosion.

## Specifications

Accessories supplied	DRN-XM01C2	DRN-XM01R2	DRN-XM01H2	DRN-XM01CK2	DRN-XM01HK2
Remote commander	(1)	(1)	(1)	(1)	(1)
XM antenna	—	—	(1)	(1)	(1)
Car cradle	(1)	(1)	—	(1)	—
Car stand	(1)	(1)	—	(1)	—
Screw	(5)	(5)	—	(5)	—
Cover	(1)	(1)	—	(1)	—
Ferrite core	(2)	(6)	(2)	(2)	(2)
Water proof cushion	—	—	—	(1)	—
Cable guide	—	—	—	(3)	—
Cord clamp	—	—	—	(4)	—
Cushion with the double-sided adhesive tape	—	—	—	(1)	—
Seal	—	—	—	(1)	—
Car battery cord	(1)	—	—	(1)	—
Car connecting pack	(1)	—	—	(1)	—
RF modulator	—	(1)	—	—	—
Home cradle	—	—	(1)	—	(1)
Home stand	—	—	(1)	—	(1)
Audio cord	—	—	(1)	—	(1)
AC power adaptor	—	—	(1)	—	(1)

( ): supplied (The parenthesized numbers indicate the quantity of each accessory.)  
 —: not supplied.

**Optional accessories**  
 AC power adaptor AC-E60A  
 Car battery cord DCC-E260  
 Car connecting pack CPA-7

Design and specifications are subject to change without notice.

## Precautions

- Do not install the unit where:
  - the ambient temperature exceeds 55°C (131°F).
  - it will be exposed to direct sunlight or hot air from a heater.
  - it will be exposed to rain, water, or high humidity.
  - it will be exposed to a lot of dust.
  - it will be subject to excessive vibration.
  - hinder normal driving activities.
  - jeopardize the passengers.
- Be sure to turn off the power of each component before making the connections.

## For DRN-XM01C2/XM01CK2 Customers

Be sure to check that the voltage of the equipment connected to this unit is correct. Incorrect voltage may cause the equipment to malfunction.  
 • This unit is designed for negative ground 12 or 24 V DC operation only.  
 • Avoid high temperatures, such as direct sunlight or hot air from the heater.  
 • You cannot use this unit with some car cassette deck.  
 • Used with some car cassette decks, the car connecting pack may rattle. This is not a malfunction of the car connecting pack.

**Note on the DC plug of the car battery cord**  
 This car battery cord uses a unified polarity type plug (JEITA standard). Damage will occur if it is connected to a DC power input jack without the polarity symbol or with another symbol.

## For DRN-XM01R2 Customers

- This unit is designed for negative ground 12 V DC operation only.
- Before making connections, disconnect the earth terminal of the car battery to avoid short circuits.
- Connect the red power input leads only after all other leads have been connected.
- Be sure to connect the red power input lead to the positive 12 V power terminal which is powered when the ignition switch is in the accessory position.
- Run all earth wires to a common earth point.

## For DRN-XM01H2/XM01HK2 Customers

**On installing the AC power adaptor**  
 Do not place the AC power adaptor in a location where it is subject to:  
 - extreme high temperature (E.g., in a car with its windows closed)  
 - direct sunlight or near a heat source  
 - mechanical vibration or shock  
 - a magnetic field (E.g., near a magnet, speaker, or TV)  
 - excessive dust.

## On operating the AC power adaptor

- Make sure the current and voltage of the equipment matches that of the outlet.
- For safety, if the input current is too high, the unit will automatically shut down.
- Do not use the unit near a TV set. If you place equipment too close to the unit while they are being used, you may experience some interference.
- To prevent damage, be careful not to drop or otherwise cause a mechanical shock to the unit.
- After using, disconnect the unit from the wall outlet and the equipment.
- Disconnect the unit from the AC outlet by pulling on the plug. Do not pull on the cord.
- To avoid short-circuiting, do not allow the terminals of the unit or connector to touch any metal object.
- Use only the recommended AC power adaptor.

## For All Customers

- On cleaning**
- Clean the unit with a soft, dry cloth. If the unit is very dirty, wipe it off with a soft cloth lightly moistened with a mild detergent solution, and then wipe with a soft dry cloth.
  - Do not use any type of solvent such as alcohol, thinner, or benzine as it may damage the finish of the cabinet.
  - If you use any chemical cleaner, observe the instructions provided with the product.
  - If the cabinet of the unit is splashed with any type of solvent such as insecticide, or remains in contact for a long time with rubber or vinyl,